

版次 0	变更摘要	日期	序号	品名	材质
			①	MX3.0双排直针WTB胶芯	PA66 UL94V-0 黑色
			②	MX3.0双排直针WTB端子	铜合金/表面镀锡

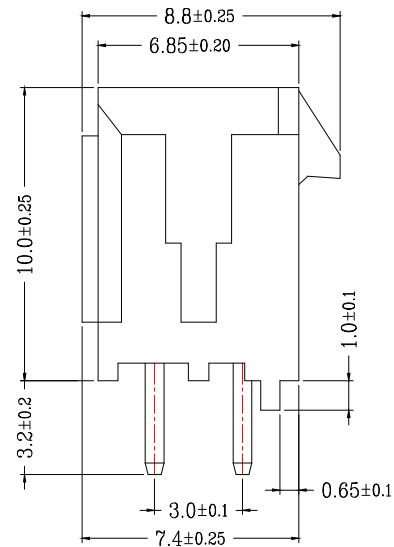

TYPE 1 (无K脚)

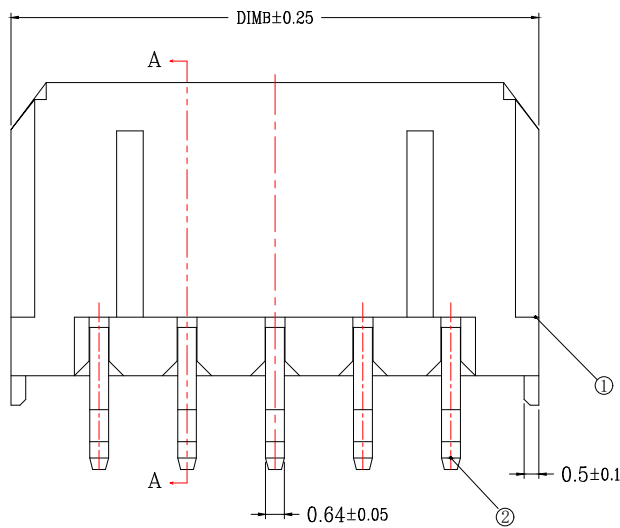
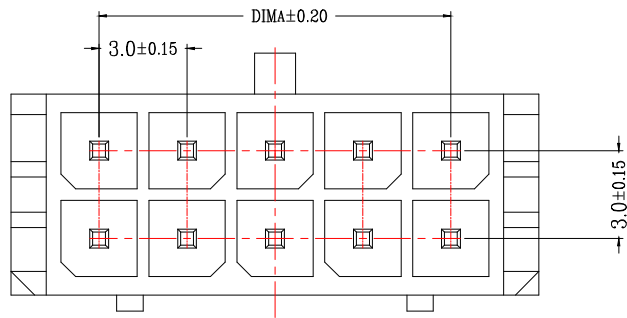
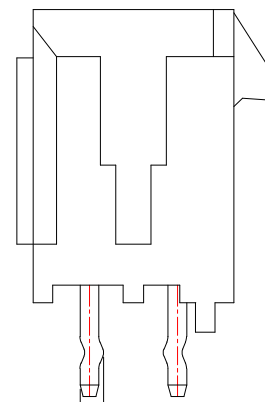

TYPE 2 (打K脚)

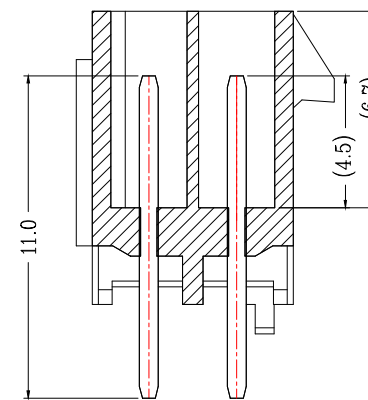
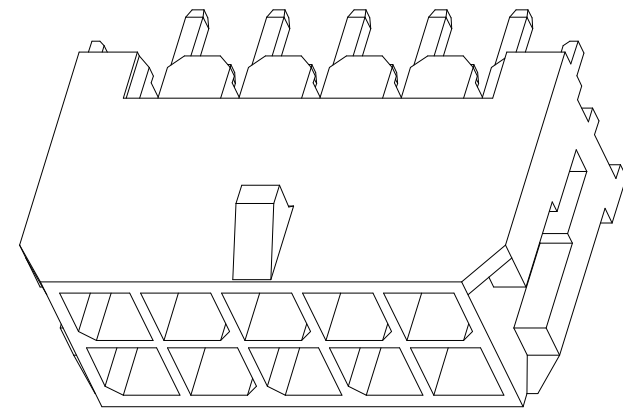

SECTION A-A

CKT	A	B
2*1		6.00
2*2	3.0	9.00
2*3	6.0	12.00
2*4	9.0	15.00
2*5	12.0	18.00
2*6	15.0	21.00
2*7	18.0	24.00
2*8	21.0	27.00
2*9	24.0	30.00
2*10	27.0	33.00
2*11	30.0	36.00
2*12	33.0	39.00

技术指标 (Technical Index):

1. 温度范围 (Temperature range):  $-25^{\circ}\text{C} \sim +85^{\circ}\text{C}$ .
2. 额定电压 (Rated voltage): 600V, AC, DC.
3. 额定电流 (Rated current): 5.0A AC, DC.
4. 接触电阻 (Contact resistance):  $\leq 20\text{m}\Omega$ .
5. 耐压值 (Withstanding voltage): 1500V AC/minute.
6. 绝缘电阻 (Insulation resistance):  $\geq 1000\text{M}\Omega$ .

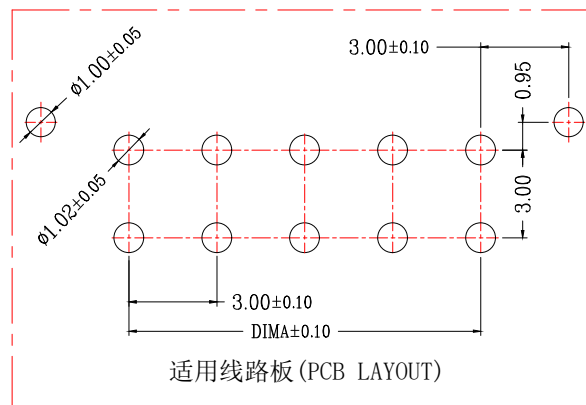

适用线路板 (PCB LAYOUT)



一般公差 (TOLERANCE)  
 X: ±.50 XX: ±1.0  
 .X: ±.20 .XXX: ±.05  
 ANGLES: ±1°

兆星精密电子 (深圳) 有限公司

品名 (TITLE)	MX3.0双排直针WTB	制图 (DR)	
料号 (DWG.NO)	ZX-MX3.0-2-2PZZ	校对 (CHKD)	
比例 (SCALE)	1:1	审核 (APPD)	
单位 (UNITS)	mm	张数 (SHEET)	1 OF 1
		SIZE	A4
		REV	A

## X-ON Electronics

Largest Supplier of Electrical and Electronic Components

*Click to view similar products for [Headers & Wire Housings](#) category:*

*Click to view products by [Megastar](#) manufacturer:*

Other Similar products are found below :

[0015917161](#) [0022155065](#) [57102-F02-18ULF](#) [58102-G61-06LF](#) [582553-1](#) [01.001.5753.1](#) [0050291907](#) [02.125.8002.8](#) [609-3404](#) [61062-3](#)  
[CSU011177004](#) [622-0430](#) [622-3653LF](#) [63453-116](#) [636-1030](#) [636-1427](#) [636-3427](#) [636-4007](#) [641938-9](#) [65495-038](#) [65692-001LF](#) [65781-018](#)  
[65781-047](#) [65817-010LF](#) [65817-015LF](#) [67095-007LF](#) [67601157](#) [68631-112](#) [68645-018](#) [699319-000](#) [70.362.1628.0](#) [70-4210](#) [70-4226B](#) [70-](#)  
[4853B](#) [71.350.2428.0](#) [733-134](#) [733-162](#) [760-3052](#) [MHR-64-VUAL](#) [80.063.4001.1](#) [800-90-001-10-001000](#) [801-43-002-10-013000](#)  
[801-43-006-10-002000](#) [803-43-024-10-001000](#) [803-93-012-10-001000](#) [8-1437020-4](#) [819-22-004-30-001101](#) [820-22-006-30-001101](#)  
[820-22-008-30-001101](#) [821-22-002-10-001101](#)