

版次	变更摘要	日期
0	新产品发行	2018/09/16
1	2P/3P卡扣尺寸由3.0mm变更为3.2mm, 避空公头干涉	2021/11/15

序号	品名	材质
①	2.0-A型双排母式DIP型WTB胶芯 2.0 Pitch T/H R/A Wire To Board Housing(H=8.0)	PA46 UL94V-0 白色 White
②	2.0-A型双排母式DIP型WTB长端子 2.0 Pitch T/H R/A Wire To Board Long Terminal(H=8.0)	铜合金/表面镀锡 Copper Alloy/ Tin Plating
③	2.0-A型双排母式DIP型WTB短端子 2.0 Pitch T/H R/A Wire To Board Short Terminal(H=8.0)	铜合金/表面镀锡 Copper Alloy/ Tin Plating

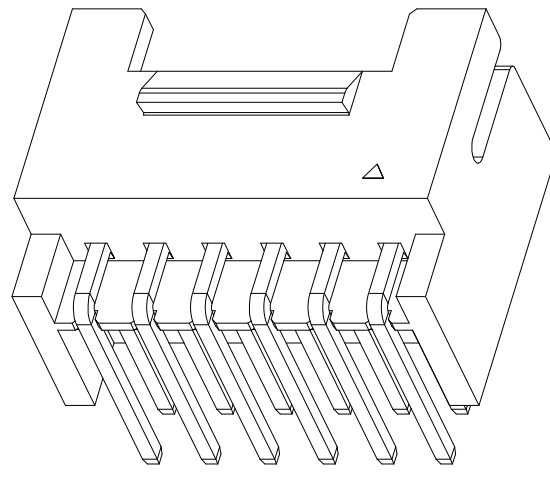
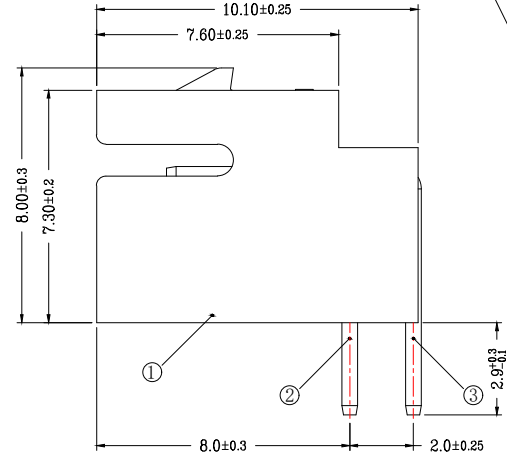
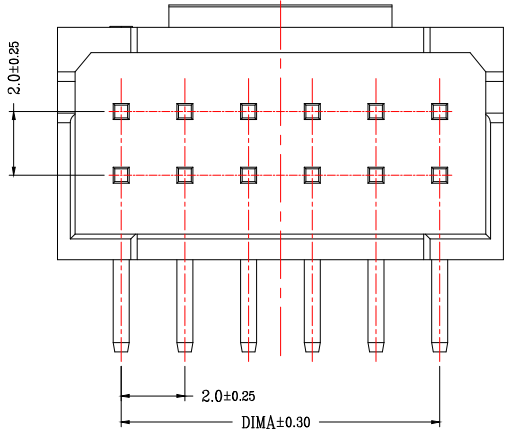
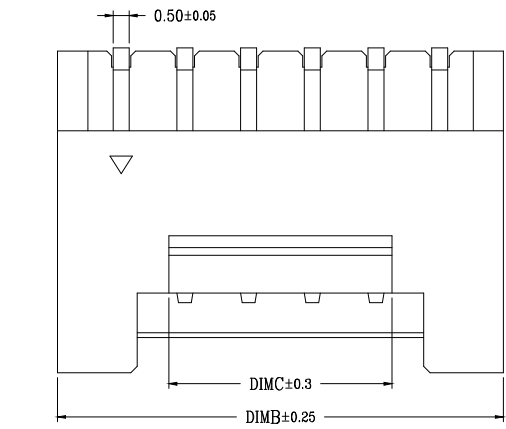

- 技术指标:
1. 塑件表面应光洁、无毛边、无明显收缩、缺陷、裂纹等现象。
 2. 工作温度: -25° C~85° C.
 3. 额定电压: 250V DC/AC(rms).
 4. 额定电流: 3.0A AC, DC.
 5. 接触电阻: ≤20mΩ.
 6. 耐压值: 800V AC/minute.
 7. 绝缘电阻: ≥1000MΩ.

CKT	DIM A	DIM B	DIM C
2*2	2.0	6.0	3.2
2*3	4.0	8.0	3.2
2*4	6.0	10.0	3.0
2*5	8.0	12.0	5.0
2*6	10.0	14.0	7.0
2*7	12.0	16.0	9.0
2*8	14.0	18.0	11.0
2*9	16.0	20.0	13.0
2*10	18.0	22.0	15.0
2*11	20.0	24.0	17.0
2*12	22.0	26.0	19.0
2*13	24.0	28.0	21.0
2*14	26.0	30.0	23.0
2*15	28.0	32.0	25.0
2*16	30.0	34.0	27.0
2*17	32.0	36.0	29.0
2*18	34.0	38.0	31.0
2*19	36.0	40.0	33.0
2*20	38.0	42.0	35.0
2*21	40.0	44.0	37.0
2*22	42.0	46.0	39.0

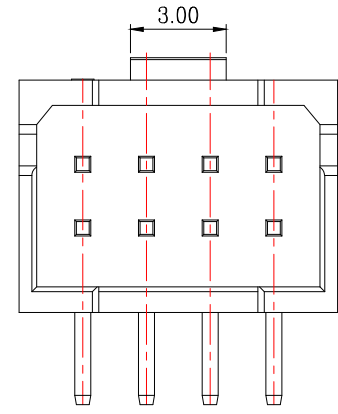
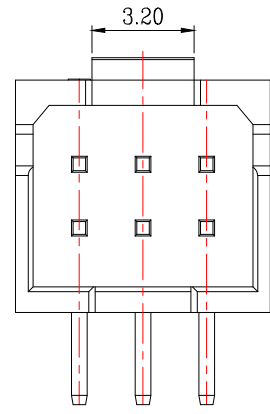
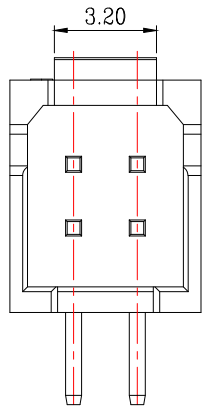
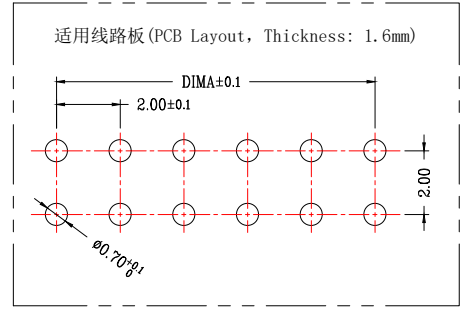

2~3P结构 (2~3Pin Structure)

4P 结构 (4 Pin Structure)



一般公差 (TOLERANCE)
 X: ±0.50 XX ±1.0
 .X ±0.20 .XXX ±0.05
 ANGLES ±1°

兆星精密电子 (深圳) 有限公司

品名 (TITLE): 2.0 Pitch A型双排弯插
 料号 (DWG.NO): ZX-PHB2.0-2-2PWZ
 比例 (SCALE): 1:1
 单位 (UNITS): mm

制图 (DR):
 校对 (CHKD):
 审核 (APPD):

张数 (SHEET): 1 OF 1
 SIZE: A4
 REV: A

X-ON Electronics

Largest Supplier of Electrical and Electronic Components

Click to view similar products for [Headers & Wire Housings](#) category:

Click to view products by [Megastar](#) manufacturer:

Other Similar products are found below :

[0015917161](#) [0022155065](#) [57102-F02-18ULF](#) [58102-G61-06LF](#) [582553-1](#) [01.001.5753.1](#) [0050291907](#) [02.125.8002.8](#) [609-3404](#) [61062-3](#)
[CSU011177004](#) [622-0430](#) [622-3653LF](#) [63453-116](#) [636-1030](#) [636-1427](#) [636-3427](#) [636-4007](#) [641938-9](#) [65495-038](#) [65692-001LF](#) [65781-018](#)
[65781-047](#) [65817-010LF](#) [65817-015LF](#) [67095-007LF](#) [67601157](#) [68631-112](#) [68645-018](#) [699319-000](#) [70.362.1628.0](#) [70-4210](#) [70-4226B](#) [70-](#)
[4853B](#) [71.350.2428.0](#) [733-134](#) [733-162](#) [760-3052](#) [MHR-64-VUAL](#) [80.063.4001.1](#) [800-90-001-10-001000](#) [801-43-002-10-013000](#)
[801-43-006-10-002000](#) [803-43-024-10-001000](#) [803-93-012-10-001000](#) [8-1437020-4](#) [819-22-004-30-001101](#) [820-22-006-30-001101](#)
[820-22-008-30-001101](#) [821-22-002-10-001101](#)