

**SPECIFICATIONS:**

**1. ELECTRICAL CHARACTERISTICS:**

- 1-1. CONTACT RESISTANCE: 30mΩ MAX.
- 1-2. DIELECTRIC WITHSTANDING VOLTAGE: 100V DC FOR ONE MINUTE
- 1-3. INSULATION RESISTANCE: 100MΩ MIN. MEASURED BY 500 VDC

**2. MECHANICAL CHARACTERISTICS:**

- 2-1. INSERTION FORCE: 0.5-2.0kgf(REF.)
- 2-2. HOLDING FORCE: 0.8-2.0gf(REF.)

**3. LIFE TEST: 10,000 CYCLES.**

**4. TO CONFORM TO THE MIL-COMM HAZARDOUS SUBSTANCE FREE SPEC.**

REV.	ECN NO OR DESCRIPTION	REVISED	DATE
A	PROPOSE ONLY		

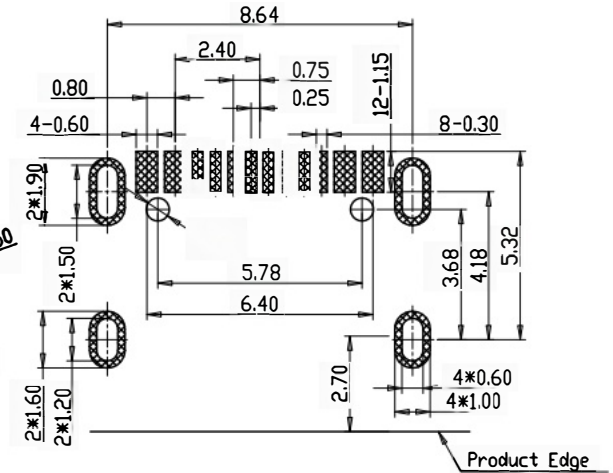
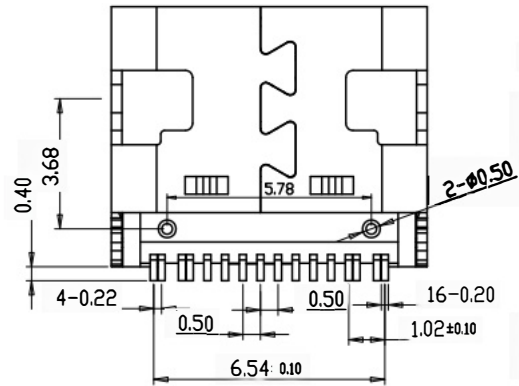
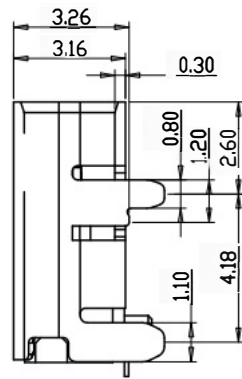
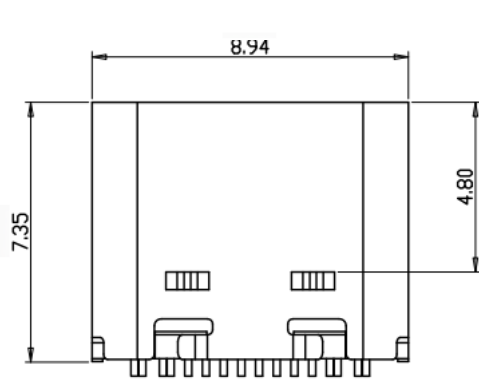
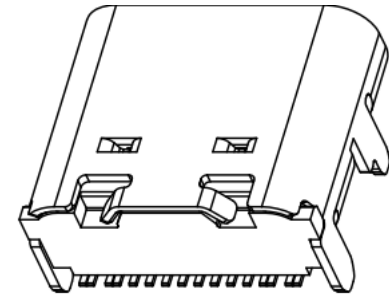

RECOMMENDED P.C.B. LAYOUT (T:1.00mm)  
TOLERANCE UNSPECIFIED ±0.05mm

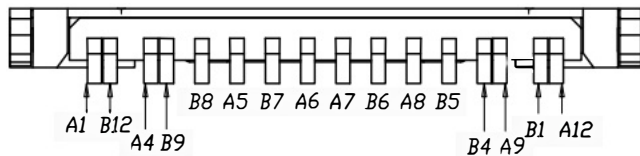
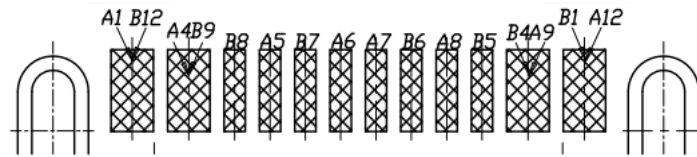
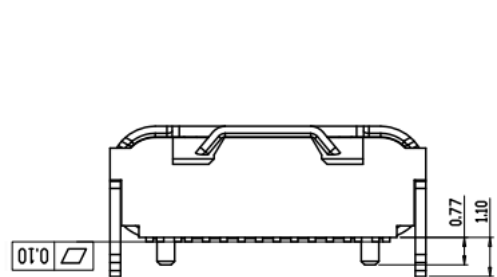

A1	GND	B:2	GND
A4	VBUS	B9	VBUS
A5	CC1	B8	SBU2
A6	DP1	B7	DN2
A7	DN1	B6	DP2
A8	SBU1	B5	CC2
A9	VBUS	B4	VBUS
A12	GND	B1	GND

6	SHELL	STAINLESS STEEL	NI Plated	1PCS
5	SHIELDING PLATE	STAINLESS STEEL	---	1PCS
4	MD	HIGH TEMPERATURE PLASTIC	BLACK	1PCS
3	CONTACT	COPPER ALLOY	Au/Ni Plated	1SET
2	CONTACT	COPPER ALLOY	Au/Ni Plated	1SET
1	HOUSING	HIGH TEMPERATURE PLASTIC	BLACK	1PCS
NO.	DESCRIPTION	MATERIAL	REMARKS	QTY

UNLESS OTHERWISE SPECIFIED TOLERANCES

DECIMALS:

X ±0.5

XX ±0.20

XXX ±0.10

ANGLES:

X ±2°

XX ±1°

兆星精密电子(深圳)有限公司

Type-C 母座 卧贴

ZX-TYPEC-WTM1648-C

SCALE:1:1 UNITS: mm

APVD SIZE: A4 SHEET: 10F1 REV: A

CUSTOMER COPY

## X-ON Electronics

Largest Supplier of Electrical and Electronic Components

*Click to view similar products for [USB Connectors](#) category:*

*Click to view products by [Megastar](#) manufacturer:*

Other Similar products are found below :

[950](#) [MUSBD11135](#) [17-200721](#) [217450-1](#) [KMBVX-TH-5S-B30](#) [KUSBX-AS2N-W](#) [KUSBX-SMT2AP1S-W30](#) [935](#) [957](#) [30-498-6](#) [SK-60A-2](#)  
[1734082-1](#) [30-470](#) [30-489](#) [30-541](#) [A-USB A-2P-C](#) [MIKROE-1451](#) [USBFTVSCCG](#) [1-1734084-2](#) [10135326-001LF](#) [4198](#) [USB-A-D-VT](#)  
[USB-A-S-RA-TSMT](#) [1310-1023-02](#) [690-024-633-031](#) [UB-20PMFP-LC7001](#) [17-200011](#) [UB-20AFMM-LL7A01](#) [1040870124](#) [CAP-](#)  
[WCCMLPB1](#) [CAP-WCCMLPC1](#) [2274475-3](#) [UB-20BMFA-SL8001](#) [914-614A2025S10200](#) [USB3FTV7SAGF059](#) [ZX40-B-5S-1500-](#)  
[STDA\(30\)](#) [GSB3116344HR](#) [USB3FTV2SAZNF459](#) [USB3FTV7SAZNF459](#) [U221-041N-1WVS62-F5D](#) [HYCW153-USBD05-500B](#)  
[HYCW219-USBD05-075B](#) [HYCW148-USBD05-117B](#) [HYCW149-USBD05-740B](#) [HYCW204-USBD05-108B](#) [HYCW214-USBA04-113B](#)  
[HYCW213-USBA04-113B](#) [UB-20AMFM-SL7A01](#) [KMMX-BSMT35S-1-B30TR](#) [2345986-1](#)