

版次	变更摘要	日期	序号	品名	材质
0			①	XH2.5直针WTB胶芯	PA66 UL94V-0 米色 白色
			②	XH2.5弯针WTB端子	铜合金/表面镀锡

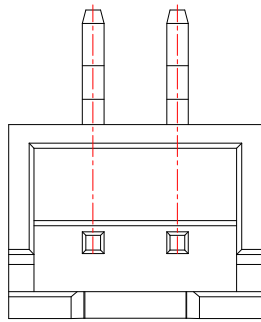

2 Pin样式

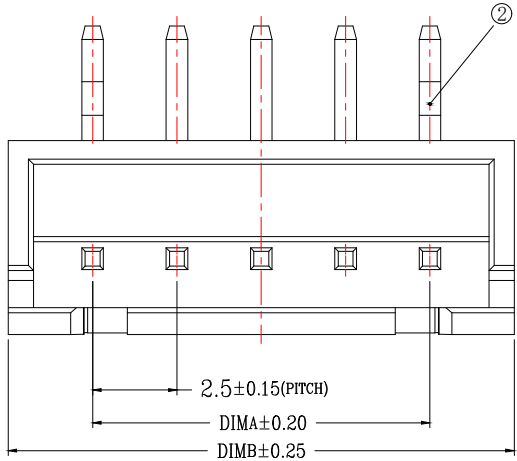
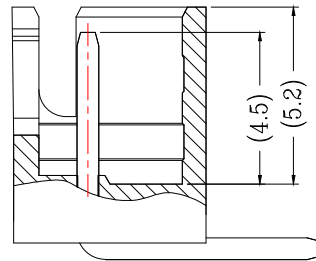

SECTION A-A

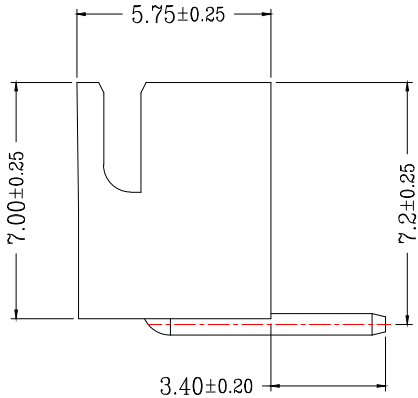
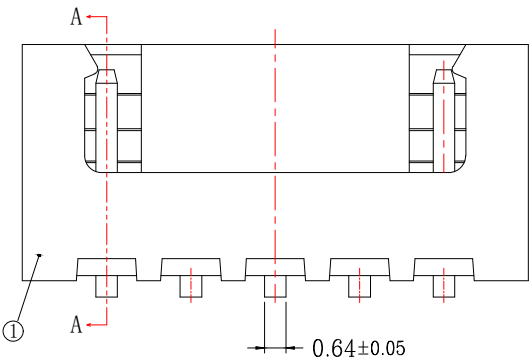
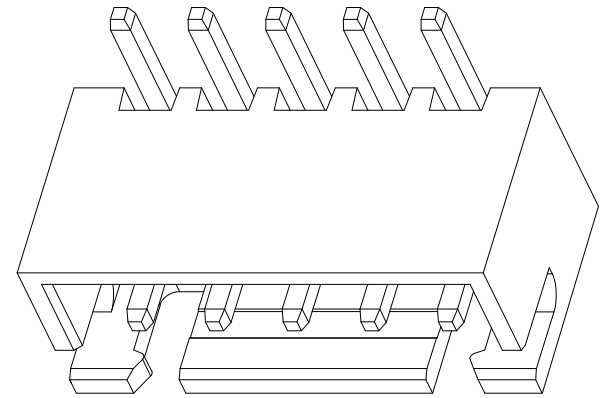

TYPE 1 (无K脚)

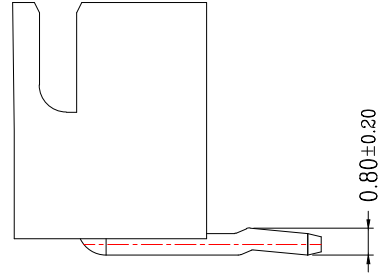

TYPE 2 (打K脚)

CKT	A	B	CKT	A	B
2	2.5	7.5	10	22.5	27.5
3	5.0	10.0	11	25.0	30.0
4	7.5	12.5	12	27.5	32.5
5	10.0	15.0	13	30.0	35.0
6	12.5	17.5	14	32.5	37.5
7	15.0	20.0	15	35.0	40.0
8	17.5	22.5	16	37.5	42.5
9	20.0	25.0			

技术指标 (Technical Index):

1. 温度范围 (Temperature range): $-25^{\circ}\text{C} \sim +85^{\circ}\text{C}$.
2. 额定电压 (Rated voltage): 250V, AC.
3. 额定电流 (Rated current): 3.0A AC, DC.
4. 接触电阻 (Contact resistance): $\leq 20\text{m}\Omega$.
5. 耐压值 (Withstanding voltage): 1000V AC/minute.
6. 绝缘电阻 (Insulation resistance): $\geq 1000\text{M}\Omega$.
7. 产品料号 (Product material No.):

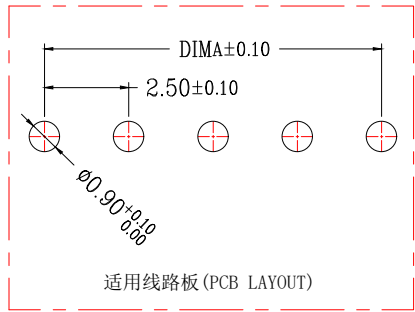

适用线路板 (PCB LAYOUT)



一般公差 (TOLERANCE)
 X: ±.50 XX ±.10
 .X ±.20 .XXX ±.05
 ANGLES ±1°

兆星精密电子 (深圳) 有限公司

品名 (TITLE) 单排XH2.54 n*Pin 弯针 红色/黄色	制图 (DR)
料号 (DWG.NO) ZX-XH2.54-nPWZ-R	校对 (CHKD)
比例 (SCALE) 1:1	审核 (APPD)
单位 (UNITS) mm	张数 (SHEET) 1 OF 1
	SIZE A4
	REV A

X-ON Electronics

Largest Supplier of Electrical and Electronic Components

Click to view similar products for [Headers & Wire Housings](#) category:

Click to view products by [Megastar](#) manufacturer:

Other Similar products are found below :

[0015917161](#) [0022155065](#) [57102-F02-18ULF](#) [58102-G61-06LF](#) [582553-1](#) [01.001.5753.1](#) [0050291907](#) [02.125.8002.8](#) [609-3404](#) [61062-3](#)
[CSU011177004](#) [622-0430](#) [622-3653LF](#) [63453-116](#) [636-1030](#) [636-1427](#) [636-3427](#) [636-4007](#) [641938-9](#) [65495-038](#) [65692-001LF](#) [65781-018](#)
[65781-047](#) [65817-010LF](#) [65817-015LF](#) [67095-007LF](#) [67601157](#) [68631-112](#) [68645-018](#) [699319-000](#) [70.362.1628.0](#) [70-4210](#) [70-4226B](#) [70-](#)
[4853B](#) [71.350.2428.0](#) [733-134](#) [733-162](#) [760-3052](#) [MHR-64-VUAL](#) [80.063.4001.1](#) [800-90-001-10-001000](#) [801-43-002-10-013000](#)
[801-43-006-10-002000](#) [803-43-024-10-001000](#) [803-93-012-10-001000](#) [8-1437020-4](#) [819-22-004-30-001101](#) [820-22-006-30-001101](#)
[820-22-008-30-001101](#) [821-22-002-10-001101](#)