



连云港美华电子科技有限公司
Lianyungang Meihua Electronics Technology Co.,Ltd

产品规格书

DATA SHEET

Part No: MHS153PTBT
REV.1

本产品符合 ROHS 指令有关限制有害物质的环保要求.

日期 DATE	拟制 PREPARED	审核 VERIFIED	批准 APPROVED
2018-05-16	Bob		JOHN

客户签回 CUSTOMER'S APPROVAL

电 话 Tel: 0518-83286000

传 真 Fax: 0518-83696699

邮件 E-mail: sales@lygmh.com.cn

网 址 Web: <http://www.lygmh.com.cn>

地址 ADD: 中国·江苏省连云港市灌南经济开发区北环路

North Around Road,Guannan EDA,Lianyungang City,Jiangsu Province China.



连云港美华电子科技有限公司

P/N: MHS153PTBT

LED SMD

产品外观尺寸 PACKAGE DIMENSIONS

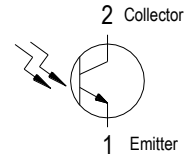
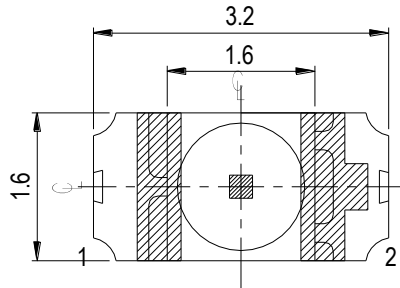

Polarity

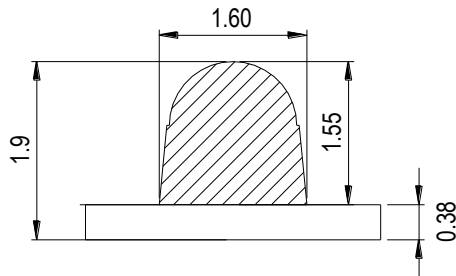

Recommended Solder Pad

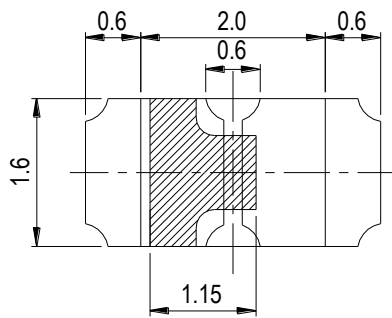
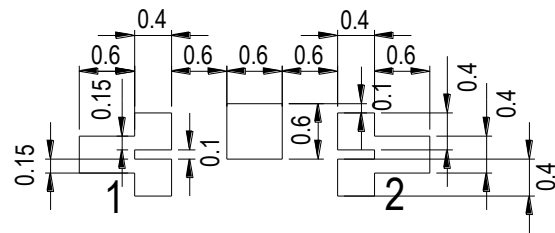

Component Location on pad

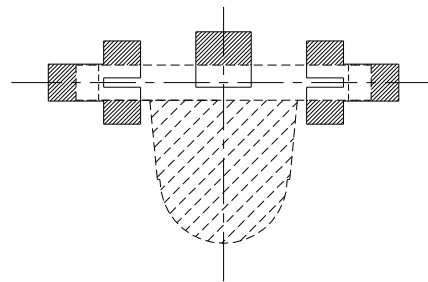

注意 NOTES :

1. 所有尺寸均为 mm(英寸)

All dimensions are in millimeters. (inches)

2. 如无特殊说明, 公差为 0.1mm

Tolerance is ± 0.1 mm unless otherwise specified.



连云港美华电子科技有限公司

P/N: MHS153PTBT

LED SMD

产品特性 FEATURES

- 高可靠性和高稳定性
High intensity and reliability
- 高品质、和低功耗、低成本
High quality, Low power requirement and low cost
- 快速响应时间
Fast response time
- 符合 RoHS 指令要求
ROHS COMPLIANC
- 无铅产品
Pb FREE PRODUCTS

产品特征 Description

- 1206 规格封装
1206 package
- 顶部发光
Top view LED
- 发光颜色 Emitted color:
 1. 红外接收: PT
 - 2.
 - 3.
- 晶片材质 Chips materials:
 1. 硅材料 SILICON
 - 2.
 - 3.
- 胶体类型 Lens Type
黑色 Black



连云港美华电子科技有限公司

P/N: MHS153PTBT

LED SMD

极限参数 Absolute Maximum Ratings(Ta=25°C)

参数 Parameter	符号 Symbol	极限值 Rating	单位 Unit
集电极-发射极电压 Collector-Emitter Voltage	VCEO	30	V
发射极-集电极发射极电压 Emitter-Collector Voltage	VECO	5	V
集电极电流 Collector Current	IC	20	mA
在（或低于）25°C自由空气温度下的功耗 Power Dissipation at(or below) 25°C Free Air Temperature	Pc	75	mW
工作温度 Operating Temperature Range	TOPR	-25°C to 85°C	
储藏温度 Storage Temperature Range	TSTG	-45°C to 85°C	
回流焊温度 Soldering Temperature	TSOL	260°C	



连云港美华电子科技有限公司

P/N: MHS153PTBT

LED SMD

光电特性 Optical-Electrical Characteristic(Ta=25°C)

符号 Symbol	参数 Parameter	测试条件 Test Condition	最小 Min	标准 Typ	最大 Max	单位 Unit
BVCEO	集电极-发射极击穿电压 Collector-Emitter Breakdown Voltage	Ic = 500 uA Ee = 0mw/cm2	60	-	-	V
BVCEO	发射极-集电极击穿电压 Emitter-Collector Breakdown Voltage	IE = 50 uA Ee = 0mw/cm2	7	-	-	V
ICEO	集电极暗电流 Collector Dark Current	VCE=10V Ee=0mw/cm2	-	-	50	uA
VCE(S)	集电极-发射极饱和电压 Collector-Emitter Saturation Voltage	Ic = 5mA Ee=1mw/cm2	-	-	0.4	V
TR/TF	上升/下降时间 Rise / Fall Time	VCE=5V IC=1mA RL=1000Ω	-	15/15	-	uS
IC(ON)	有载集电极电流 On Stat Collector Current	VCE=5V Ee=0.1mw/cm2	0.3	-	-	mA
λP	峰值灵敏度波长 Peak Sensitmty Wavelength	-	-	940	-	nm
λ0.5	谱带宽度范围 Rang Of Spectral Band width	730	-	-	1100	nm



光电特性图 Typical Electrical Characteristic Curves(Ta=25°C)

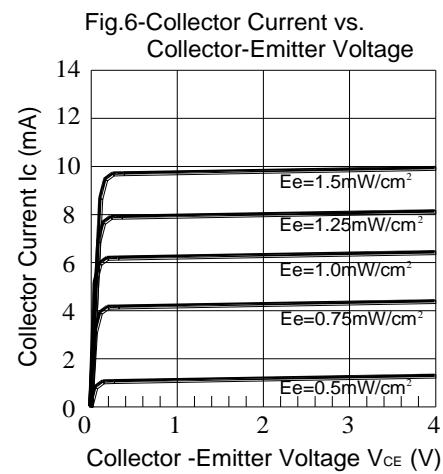
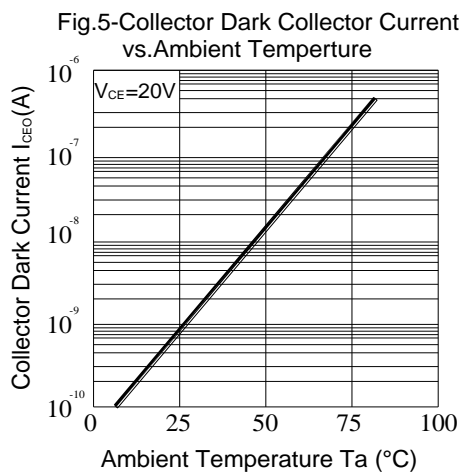
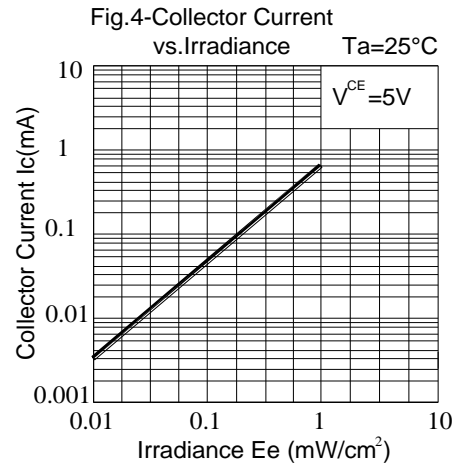
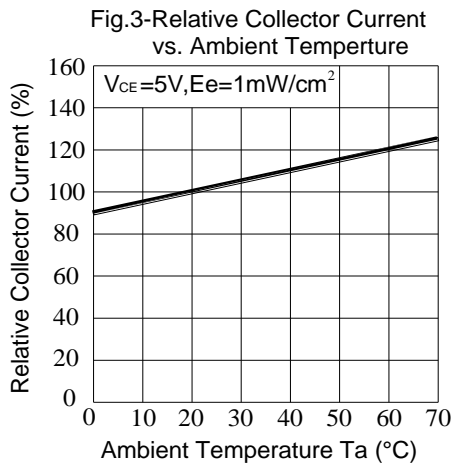
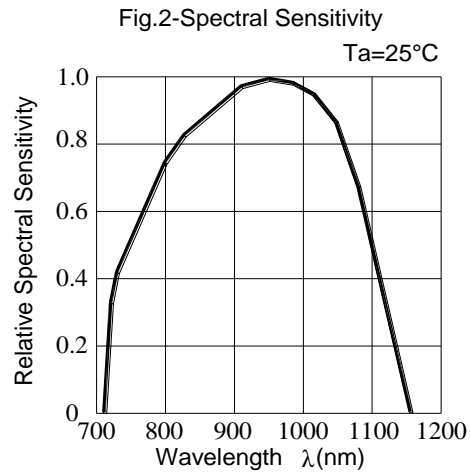
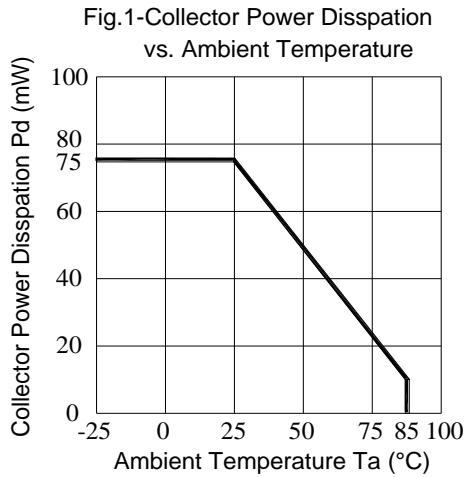



连云港美华电子科技有限公司

P/N: MHS153PTBT

LED SMD

可靠度测试及条件 Reliability Test Items and Conditions

编号 No.	项目 Items	测试条件 Test Condition	测试时间 Test Hours/Cycles	样品数量 Sample Size	判定标准 Ac/Re
1	回流焊 Reflow Soldering	260°C/10sec.	6 Min.	22pcs	0/1
2	热冲击 Thermal Shock	H : +100°C 5min ∩ 10 sec L : -10°C 5min	300 Cycles	22pcs	0/1
3	温度循环 Temperature Cycle	H : +100°C 15min ∩ 5 min L : -40°C 15min	300 Cycles	22pcs	0/1
4	高温高湿测试 High Temperature/Humidity Reverse Bias	Ta=85°C,85%RH	1000 Hrs.	22pcs	0/1
5	低温贮藏 Low Temperature Storage	Ta=-40°C	1000 Hrs.	22pcs	0/1
6	高温贮藏 High Temperature Storage	Ta=100°C	1000 Hrs.	22pcs	0/1
7	寿命测试 DC Operation Life	V _{CE} =5V	1000 Hrs.	22pcs	0/1



连云港美华电子科技有限公司

P/N: MHS153PTBT

LED SMD

焊接条件 Soldering Condition

方法 METHOD	焊接条件 SOLDERING CONDITIONS	备注 REMARK
回流焊 Reflow Soldering	260°C for 10 sec/1 time.	
烙铁焊 Soldering Iron	350°C for 3 sec/1 time.	使用 25W 以下功率的电烙铁 the soldering iron capacity 25W

无铅制程炉温曲线 Pb-free solder temperature profile

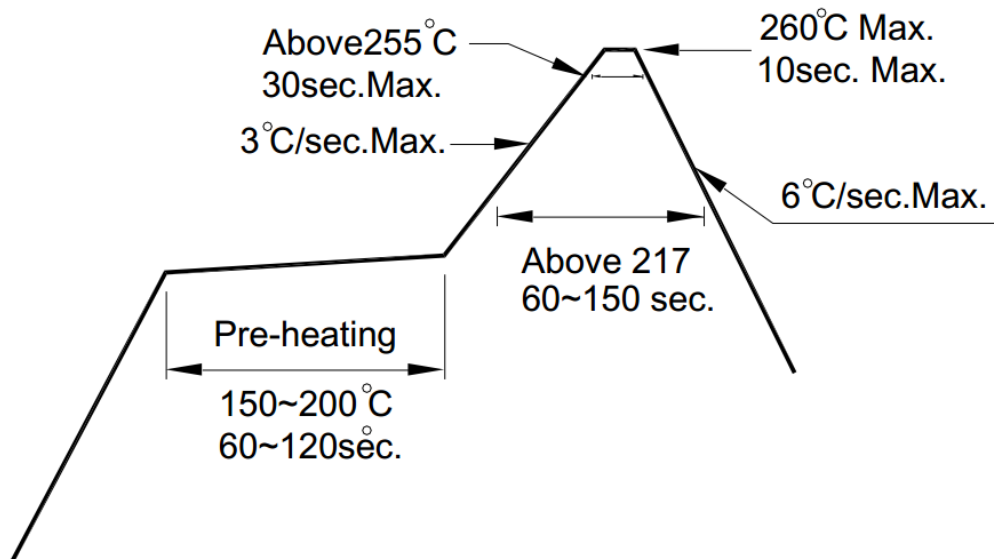

Notes:

- 过回流焊次数不可超过 2 次。
Reflow soldering should not be done more than two times.
- 焊接加热过程中不要挤压 LED
When soldering, do not put stress on the LEDs during heating.
- 不应在焊接发光二极管后弯曲 PCB 板
After soldering, do not warp the circuit board
- 客户在设计使用时需串联保护电阻，避免电压波动烧毁发光二极管。
Customer must apply resistors for protection; otherwise slight voltage shift will cause big current change (Burn out will happen)



连云港美华电子科技有限公司

P/N: MHS153PTBT

LED SMD

包装 Packing

1. 卷轴尺寸 Reel Dimensions

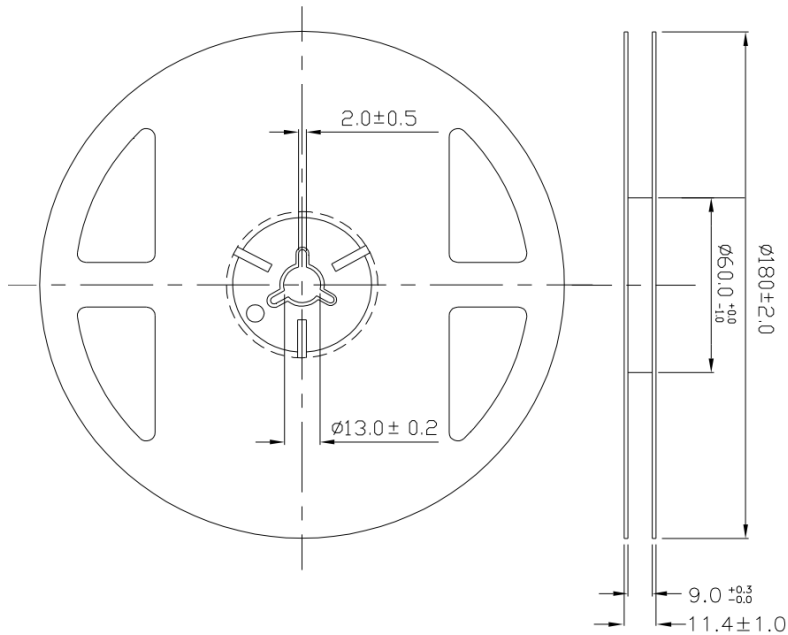

2. 载带尺寸 Carrier Tape Dimensions

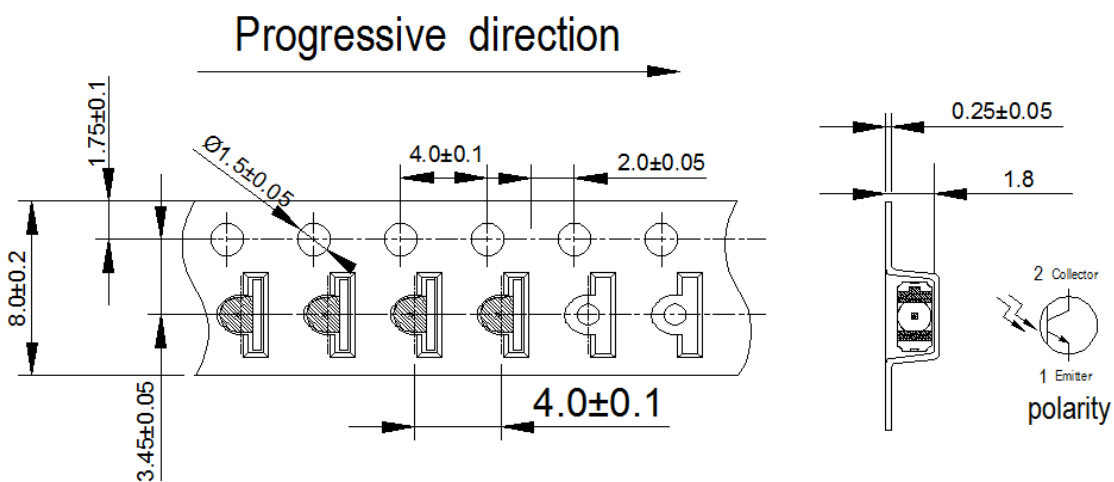

Notes:

1. 量测公差为 ± 0.1 mm, 单位是毫米。

Tolerances unless mentioned ± 0.1 mm, Unit = mm

2. 最小包装数量为每卷 2000pc

Minimum packing amount is 2000 pcs per reel



连云港美华电子科技有限公司

P/N: MHS153PTBT

LED SMD

储藏 STORAGE

1. LED 在出厂后可在温度 30 度以下，湿度 70% 以下的环境内保存 3 个月时间 The LED should be stored at 30°C or less and 70% RH or less after being shipped from MH and the storage life limits are 3 months.
2. 美华的 LED 是铁合金镀锡的，表面的镀层会被腐蚀性气体侵蚀，因此不要将它保存在可能导致支架氧化，失去光泽或变色的环境，这些腐蚀可能会导致焊接困难，建议尽快使用 Meihua's LED lead frames are comprised of a stannum plated iron alloy. The silver surface may be affected by environments which contain corrosive gases and so on. Please avoid conditions which may cause the LED to corrode, tarnish or discolor. This corrosion or discoloration may cause difficulty during soldering operations. It is recommended that the LED be used as soon as possible.
3. 请避免保存在温度变化明显，尤其是高湿度的地方 Please avoid rapid transitions in ambient temperature, especially, in high humidity environments where condensation can occur.

使用注意事项 Application Restrictions

1. 本文档中所描述的规范。上述规格可变更不通知。美华将对上述规格的材料更改的保留权。specification described in this document. Above specification may be changed without notice. Meihua will reserve authority on material change for above specification.
2. 使用本产品时，请遵守绝对最大额定值及这些规格书的使用说明。美华不负责的使用造成的任何损害承担产品不符合绝对最大额定值，并在这些指令中包含规格书。When using this product, please observe the absolute maximum ratings and the instructions for using outlined in these specification sheets. Meihua assumes no responsibility for any damage resulting from use of the product which does not comply with the absolute maximum ratings and the instructions included in these specification sheets.
3. 这些规格表包括美华公司下版权保护的材料。请不要复制或导致任何人没有提供同意复制。These specification sheets include materials protected under copyright of Meihua Corporation. Please don't reproduce or cause anyone to reproduce them without Meihua's consent.



连云港美华电子科技有限公司

P/N: MHS153PTBT

LED SMD

4. 静电放电（静电放电）ESD (Electrostatic Discharge)

产品敏感的静电或冲击电压。当使用产品时静电放电会损坏模具及其可靠性。对静电放电的措施强烈推荐：**The products are sensitive to static electricity or surge voltage. ESD can damage a die and its reliability. When handling the products, the following measures against electrostatic discharge are strongly recommended:**

消除电荷 **Eliminating the charge**

接地的手环，防静电鞋，衣服和地板 **Grounded wrist strap, ESD footwear, clothes, and floors**

接地的工作站设备和工具 **Grounded workstation equipment and tools**

导电材料的防静电工作台/架子 **ESD table/shelf mat made of conductive materials**

正确的接地用于所有装置、设备和机器生产过程所必须。在产品设计时应考虑冲击保护。**Proper grounding is required for all devices, equipment, and machinery used in product assembly. Surge protection should be considered when designing of commercial products.**

如果工具或设备含有绝缘如玻璃或塑料材料，需要做下列静电放电预防措施：**If tools or equipment contain insulating materials such as glass or plastic, the following measures against electrostatic discharge are strongly recommended:**

用导电材料耗散静电电荷 **Dissipating static charge with conductive materials**

保持环境的湿度 **Preventing charge generation with moisture**

使用离子风扇中和静电 **Neutralizing the charge with ionizers**

5. 发光二极管正向电流方向使用，驱动电路的设计必须使 LED 在关闭的状态下不经受正向或逆向电压，如果反向电压不断应用于发光二极管，它可以导致 LED 损坏 The LEDs should be operated with forward bias. The driving circuit must be designed so that the LEDs are not subjected to forward or reverse voltage while it is off. If reverse voltage is continuously applied to the LEDs, it may cause migration resulting in LED damage.

X-ON Electronics

Largest Supplier of Electrical and Electronic Components

Click to view similar products for [Phototransistors](#) category:

Click to view products by [MEIHUA](#) manufacturer:

Other Similar products are found below :

[LTR-5576D](#) [QSD123A4R0](#) [ASDL-6620-C22](#) [OED-ST-8LR2](#) [OED-STR44B90-TR](#) [SD5410-109](#) [PT91-21C/TR7](#) [PT968-8C](#) [PT91-21C/TR10](#)
[BP 103-3/4](#) [BPY 62](#) [KPS-3227SP1C](#) [L-53P3BT](#) [L-53P3C](#) [L-93DP3BT](#) [L-93DP3C](#) [LL-503PTC2E-1AD](#) [LL-S150PTC-1A](#) [LL-S150PTD-1A](#)
[SCM-014TBT86](#) [SFH 309-56](#) [SFH 320](#) [SFH 320-3](#) [SFH 320 FA](#) [SFH 320-Z](#) [OP508FA](#) [TEMT1030](#) [LTR-301](#) [PGM5516](#) [PGM5516-MP](#)
[PGM5526-MP](#) [PGM5537-MP](#) [PGM5637D](#) [PGM5639D](#) [KPA-3010P3C](#) [VEMT4700F-GS08](#) [OP830WSL](#) [PT19-21B/L41/TR8](#) [KP-2012P3C](#)
[TEKT5400S](#) [RPT-37PB3F](#) [RPM-075PTT86](#) [SD1410-128L](#) [SFH 320 FA-4-Z](#) [SFH 313 FA-2/3](#) [SFH 320-4-Z](#) [SFH 309 FA-5/6](#)
[PT4800FE000F](#) [PT480FE0000F](#) [SFH 309-5/6](#)