



连云港美华电子科技有限公司
Lianyungang Meihua Electronics Technology Co.,Ltd

产品规格书

DATA SHEET

Part No: MHT192KGCT
REV.2

本产品符合 ROHS 指令有关限制有害物质的环保要求.

日期 DATE	拟制 PREPARED	审核 VERIFIED	批准 APPROVED
2018-07-11	John		Sunny
客户签回 CUSTOMER'S APPROVAL			

电 话 Tel: 0518-83286000

传 真 Fax: 0518-83696699

邮件 E-mail: sales@lygmh.com.cn

网 址 Web: <http://www.lygmh.com.cn>

地址 ADD: 中国·江苏省连云港市灌南经济开发区北环路

North Around Road,Guannan EDA,Lianyungang City,Jiangsu Province China.



连云港美华电子科技有限公司

P/N: MHT192KGCT

LED SMD

产品外观尺寸 PACKAGE DIMENSIONS

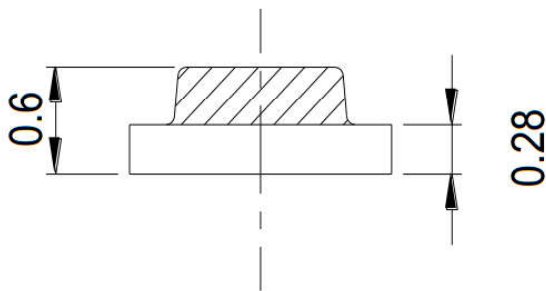
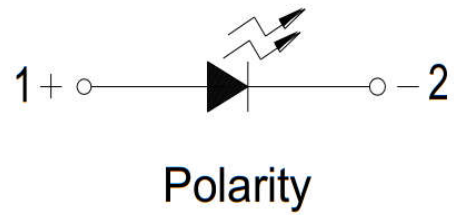
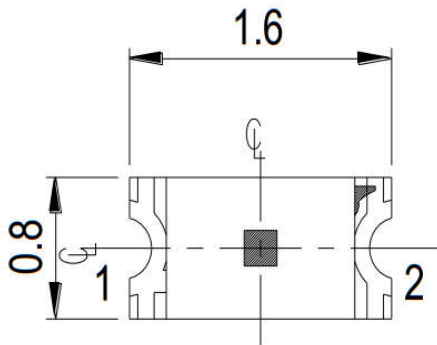

Recommended Solder Pad

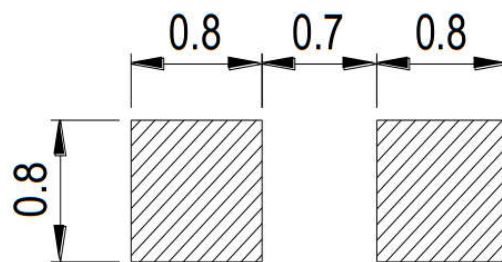
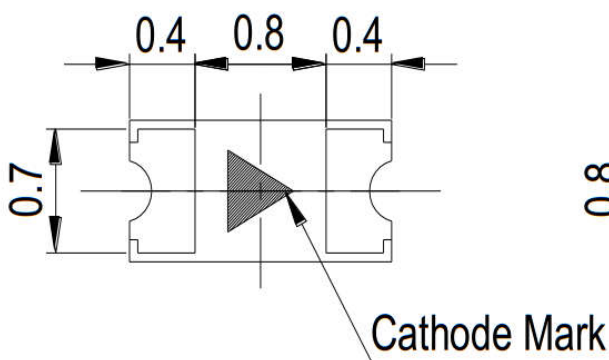

注意 NOTES :

1. 所有尺寸均为 mm(英寸)

All dimensions are in millimeters. (inches)

2. 如无特殊说明，公差为 0.10mm(0.004")

Tolerance is $\pm 0.10\text{mm}(0.004")$ unless otherwise specified.



连云港美华电子科技有限公司

P/N: MHT192KGCT

LED SMD

产品特性 FEATURES

- 高可靠性和高稳定性
High intensity and reliability
- 高品质、和低功耗、低成本
High quality, Low power requirement and low cost
- 兼容红外和气相回流焊接工艺
Compatible with infrared and vapor phase reflow solder process
- 符合 RoHS 指令要求
ROHS COMPLIANT
- 无铅产品
Pb FREE PRODUCTS
- 宽视角
Wide viewing angle.
- 静电承受能力 2000V(HBM)
ESD 2000V(HBM).

产品特征 Description

- 0603 规格封装
0603 package
- 顶部发光
Top view LED
- 胶体颜色: 透明
Lens Color: Water Clear
- 发光颜色 Emitted color:
 1. 超高亮黄绿色光: Brilliant Yellow Green
 - 2.
 - 3.
 - 4.
 - 5.
- 晶片材质 Chips materials:
 1. AlGaInP
 - 2.
 - 3.
 - 4.



连云港美华电子科技有限公司

P/N: MHT192KGCT

LED SMD

极限参数 Absolute Maximum Ratings(Ta=25℃)

参数 Parameter	符号 Symbol	极限值 Rating	单位 Unit
功耗 Power Dissipation	PAD	60	mW
最大峰值电流 Peak Forward Current Per Segment (1/10 duty cycle, 0.1ms pulse width)	IFP	60	mA
正向使用电流 Continuous Forward Current	IF	25	mA
反向电压 Reverse Voltage	VR	5	V
Electrostatic Discharge Threshold(HBM)	ESD	2000	V
工作温度 Operating Temperature Range	TOPR	-40℃ to +85℃	
储藏温度 Storage Temperature Range	TSTG	-40℃ to +100℃	

光电特性 Optical-Electrical Characteristic(Ta=25℃)

符号 Symbol	参数 Parameter	测试条件 Test Condition	最小 Min	标准 Typ	最大 Max	单位 Unit
VF	正向压降 Forward Voltage	IF = 15mA	1.8	-	2.3	V
IR	反向漏电流 Reverse Current	VR=5V	-	-	50	uA
λ_p	峰值波长 Peak Wavelength	IF = 15mA	-	575	-	nm
λ_d	主波长 Dominant Wavelength	IF = 15mA	569	-	575	nm
2 θ 1/2	发光角度 Viewing Angle	IF = 15mA	-	120	-	deg
Iv	发光强度 Luminous Intensity	IF = 15mA	45	-	75	mcd

Notes:

1. 发光强度公差为±10%。 Tolerance of Luminous Intensity ±10%.
2. 正向压降公差为±0.1V。 Tolerance of Forward Voltage : ±0.1V.
3. 使用产品时需做防静电措施。

The products are sensitive to static electricity and must be carefully taken when handling products.



光电特性图 Typical Electrical Characteristic Curves(Ta=25°C)

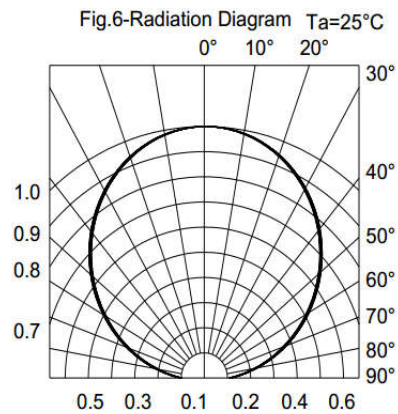
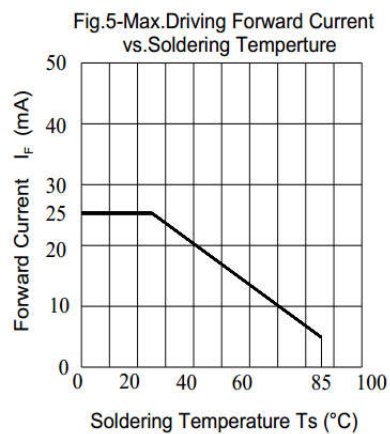
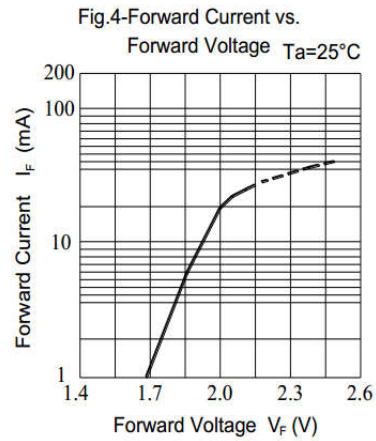
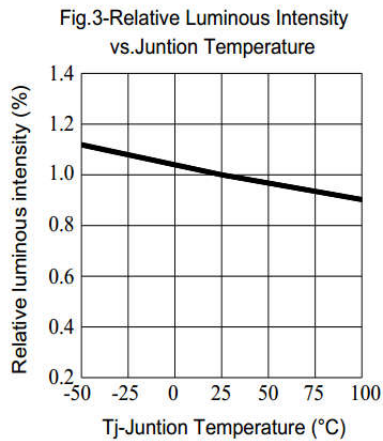
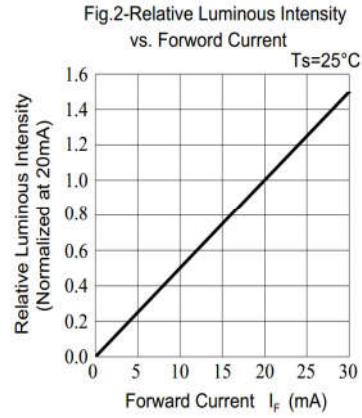
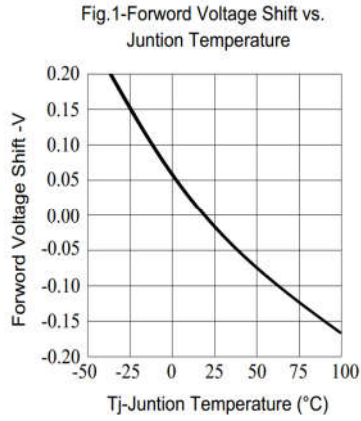

Note:

1. 发光强度取平均值。 Luminous Intensity is a average value
2. 发光强度公差: $\pm 10\%$ 。 Tolerance of Luminous Intensity: $\pm 10\%$
3. 正向电压公差: $\pm 0.1V$ 。 Tolerance of Forward Voltage: $\pm 0.1V$



连云港美华电子科技有限公司

P/N: MHT192KGCT

LED SMD

发光强度等级 Bin Range of Luminous Intensity(IV)

等级 Bin Code	最小值 Min	最大值 Max	单位 Unit	条件 Condition
1	45	50	mcd	@15mA
2	50	55	mcd	@15mA
3	55	60	mcd	@15mA
4	60	65	mcd	@15mA
5	65	70	mcd	@15mA
6	70	75	mcd	@15mA

Note:

亮度公差范围: $\pm 10\%$ 。Tolerance of Luminous Intensity: $\pm 10\%$.

主波长等级 Bin Range of Dominant Wavelength(λ_d)

等级 Bin Code	最小值 Min	最大值 Max	单位 Unit	条件 Condition
G1	569	570	nm	@15mA
G2	570	571	nm	@15mA
G3	571	572	nm	@15mA
G4	572	573	nm	@15mA
G5	573	574	nm	@15mA
G6	574	575	nm	@15mA

Note:

主波长公差范围: $\pm 1\text{nm}$ 。Tolerance of Dominant Wavelength: $\pm 1\text{nm}$.

电压等级 Bin Range of Forward Voltage(VF)

等级 Bin Code	最小值 Min	最大值 Max	单位 Unit	条件 Condition
25	1.8	1.9	V	@15mA
26	1.9	2.0	V	@15mA
27	2.0	2.1	V	@15mA
28	2.1	2.2	V	@15mA
29	2.2	2.3	V	@15mA

Note:

电压公差范围: $\pm 0.1\text{V}$ 。Tolerance of Forward Voltage: $\pm 0.1\text{V}$.



连云港美华电子科技有限公司

P/N: MHT192KGCT

LED SMD

焊接条件 Soldering Condition

方法 METHOD	焊接条件 SOLDERING CONDITIONS	备注 REMARK
回流焊 Reflow Soldering	260°C for 10 sec/1 time.	
烙铁焊 Soldering Iron	350°C for 3 sec/1 time.	使用 25W 以下功率的电烙铁 the soldering iron capacity 25W

无铅制程炉温曲线 Pb-free solder temperature profile

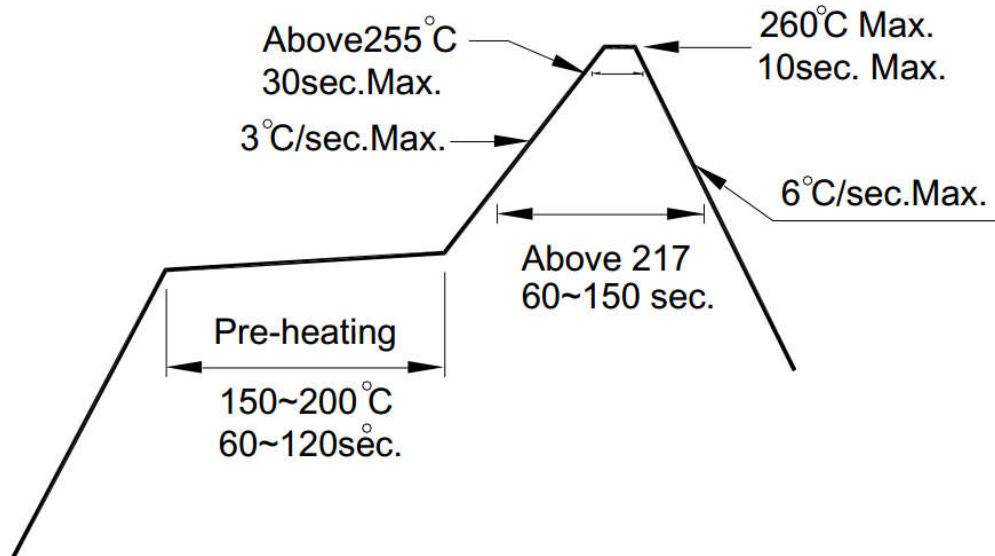

Notes:

- 过回流焊次数不可超过 2 次。
Reflow soldering should not be done more than two times.
- 焊接加热过程中不要挤压 LED
When soldering, do not put stress on the LEDs during heating.
- 不应在焊接发光二极管后弯曲 PCB 板
After soldering, do not warp the circuit board
- 客户在设计使用时需串联保护电阻，避免电压波动烧毁发光二极管。
Customer must apply resistors for protection; otherwise slight voltage shift will cause big current change (Burn out will happen)



连云港美华电子科技有限公司

P/N: MHT192KGCT

LED SMD

可靠度测试及条件 Reliability Test Items and Conditions

编号 No.	项目 Items	测试条件 Test Condition	测试时间 Test Hours/Cycles	样品数量 Sample Size	判定标准 Ac/Re
1	回流焊 Reflow Soldering	260°C/10sec.	6 Min.	22pcs	0/1
2	热冲击 Thermal Shock	H : +100°C 5min ∩ 10 sec L : -10°C 5min	300 Cycles	22pcs	0/1
3	温度循环 Temperature Cycle	H : +100°C 15min ∩ 5 min L : -40°C 15min	300 Cycles	22pcs	0/1
4	高温高湿测试 High Temperature/Humidity Reverse Bias	Ta=85°C,85%RH	1000 Hrs.	22pcs	0/1
5	低温贮藏 Low Temperature Storage	Ta=-40°C	1000 Hrs.	22pcs	0/1
6	高温贮藏 High Temperature Storage	Ta=100°C	1000 Hrs.	22pcs	0/1
7	寿命测试 DC Operation Life	Ta=25°C, If = 15mA	1000 Hrs.	22pcs	0/1



连云港美华电子科技有限公司

P/N: MHT192KGCT

LED SMD

包装 Packing

1. 卷轴尺寸 Reel Dimensions

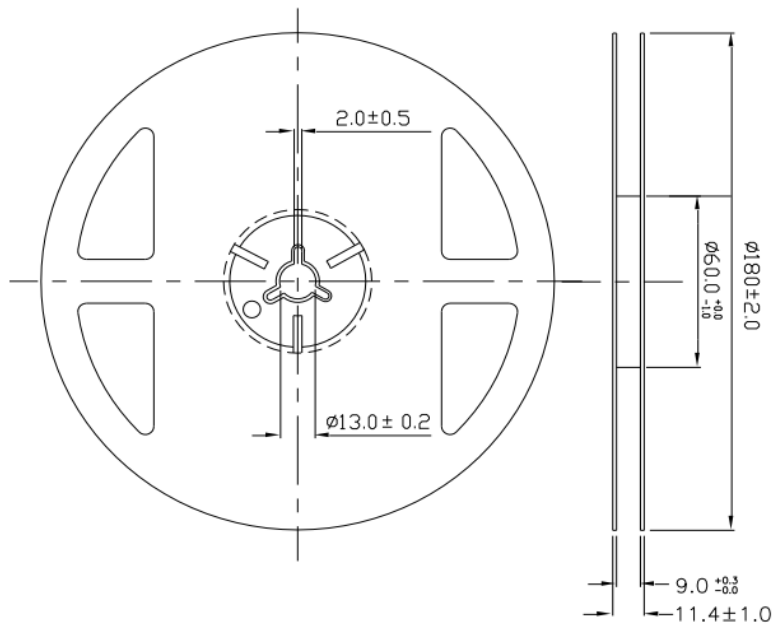

2. 载带尺寸 Carrier Tape Dimensions

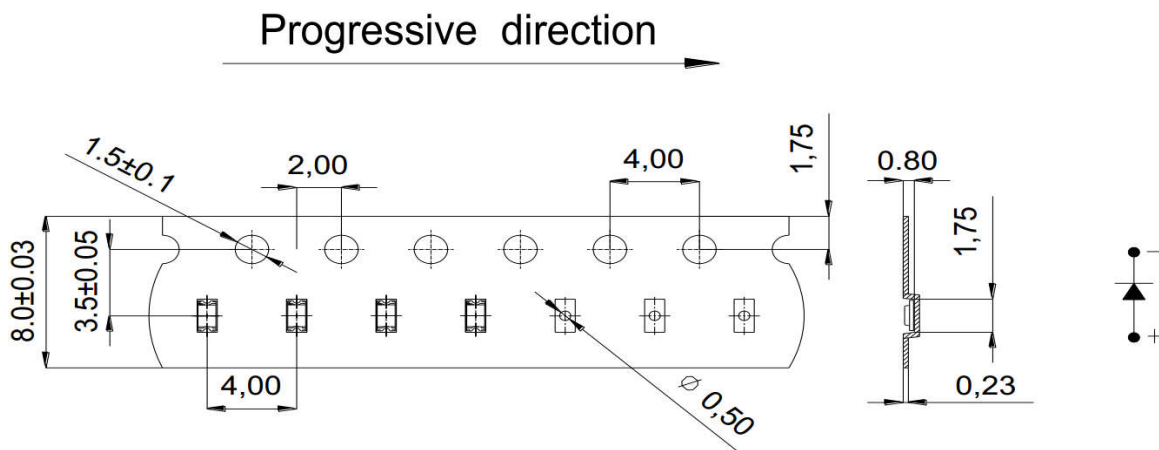

Notes:

1. 量测公差为 $\pm 0.1\text{mm}$, 单位是毫米。

Tolerances unless mentioned $\pm 0.1\text{mm}$, Unit = mm

2. 最小包装数量为每卷 4000pcs

Minimum packing amount is 4000 pcs per reel



连云港美华电子科技有限公司

P/N: MHT192KGCT

LED SMD

储藏 STORAGE

1. 发光二极管在出厂后可在温度 30 度以下,湿度 90% 以下的环境内保存 1 年。The LED should be stored at 30°C or less and 70% RH or less after being shipped from MH and the storage life limits are 1 year.
2. 在产品准备使用前请不要打开防潮袋。Do not open moisture proof bag before the products are ready to use.
3. 打开包装后: 产品暴露在温度 30 度以下湿度 60% 以下的 24 小时内用完, 若仍然有剩余, 请一定要放到防潮柜内储存。After opening the package: The LED's floor life is 24 hours. under 30°C or less and 60% RH or less. If unused LEDs remain, it should be stored in moisture proof packages.
4. 如果吸湿性材料(硅胶)已用完或发光二极管已超过存储时间, 应使用以下条件进行烘烤处理, 处理: 60±5°C 烘烤 4 小时。If the moisture absorbent material (silica gel) has faded away or the LEDs have exceeded the storage time, baking treatment should be performed using the following conditions. Baking treatment: 60±5°C for 4 hours.
3. 请避免保存在温度变化明显, 尤其是高湿度的地方 Please avoid rapid transitions in ambient temperature, especially, in high humidity environments where condensation can occur.

使用注意事项 Application Restrictions

1. 本文档中所描述的规范。上述规格可变更不通知。美华将对上述规格的材料更改的保留权。specification described in this document. Above specification may be changed without notice. Meihua will reserve authority on material change for above specification.
2. 使用本产品时, 请遵守绝对最大额定值及这些规格书的使用说明。美华不负责的使用造成的任何损害承担产品不符合绝对最大额定值, 并在这些指令中包含规格书。When using this product, please observe the absolute maximum ratings and the instructions for using outlined in these specification sheets. Meihua assumes no responsibility for any damage resulting from use of the product which does not comply with the absolute maximum ratings and the instructions included in these specification sheets.
3. 这些数据包括美华版权保护的材料。未经授权请不要复制。These specification sheets include materials protected under copyright of Meihua Corporation. Please don't reproduce or cause anyone to reproduce them without Meihua's consent.



连云港美华电子科技有限公司

P/N: MHT192KGCT

LED SMD

4. 静电放电（静电放电）ESD (Electrostatic Discharge)

产品敏感的静电或冲击电压。当使用产品时静电放电会损坏模具及其可靠性。对静电放电的措施强烈推荐: **The products are sensitive to static electricity or surge voltage. ESD can damage a die and its reliability. When handling the products, the following measures against electrostatic discharge are strongly recommended:**

消除电荷 **Eliminating the charge**

接地的手环，防静电鞋，衣服和地板 **Grounded wrist strap, ESD footwear, clothes, and floors**

接地的工作站设备和工具 **Grounded workstation equipment and tools**

导电材料的防静电工作台/架子 **ESD table/shelf mat made of conductive materials**

正确的接地用于所有装置、设备和机器生产过程所必须。在产品设计时应考虑冲击保护。**Proper grounding is required for all devices, equipment, and machinery used in product assembly. Surge protection should be considered when designing of commercial products.**

如果工具或设备含有绝缘如玻璃或塑料材料，需要做下列静电放电预防措施: **If tools or equipment contain insulating materials such as glass or plastic, the following measures against electrostatic discharge are strongly recommended:**

用导电材料耗散静电电荷 **Dissipating static charge with conductive materials**

保持环境的湿度 **Preventing charge generation with moisture**

使用离子风扇中和静电 **Neutralizing the charge with ionizers**

5. 发光二极管正向电流方向使用，驱动电路的设计必须使 LED 在关闭的状态下不经受正向或逆向电压，如果反向电压不断应用于发光二极管，它可以导致 LED 损坏。The LEDs should be operated with forward bias. The driving circuit must be designed so that the LEDs are not subjected to forward or reverse voltage while it is off. If reverse voltage is continuously applied to the LEDs, it may cause migration resulting in LED damage.

X-ON Electronics

Largest Supplier of Electrical and Electronic Components

Click to view similar products for [Standard LEDs - SMD category](#):

Click to view products by [MEIHUA manufacturer](#):

Other Similar products are found below :

[LTST-C19GD2WT](#) [LTST-N683GBEW](#) [597-3006-607F](#) [597-3403-607F](#) [LTW-K140SZR40](#) [LTW-M140ZVS](#) [598-8110-100F](#) [598-8170-100F](#)
[598-8610-202F](#) [7012X7](#) [AAAF5060QBFSEEZGS](#) [12-22SURSYGC/S530-A3/E2/TR8](#) [1383SURT/S530-A3/TR1\(R\)](#) [APT1608QGW](#)
[EASV1803BA0](#) [SML310BATT86](#) [SML-512VWT86A](#) [SML-LX0606SISUGC/A](#) [SML-LXL1307SRC-TR](#) [SML-LXR851SIUPGUBC](#)
[LT1ED53A](#) [17-21/G6C-FM1N2B/3T](#) [FAT801-S](#) [SSL-LXA227IC-TR31A](#) [AM27ZGC03](#) [APB3025SGNC](#) [APHK1608VGCA](#) [APT2012QGW](#)
[CLMVC-FKA-CA1E1L81BB7C3C3](#) [CLYBA-FKA-CFHHL9BBB7A363](#) [CMD11504UR](#) [LTW-020ZDCG](#) [LTW-21TS5](#) [LTW-K140SZR30](#)
[HSMY-C177](#) [HT-121UYG-4739](#) [UYGT801-S](#) [KVH1C100MF6R](#) [42-21SYGC/S530-E1/TR8](#) [YGFR411-H](#) [597-2311-402F](#) [597-2712-602F](#)
[5973212407NF](#) [597-3302-607F](#) [597-5202-407F](#) [598-8330-117F](#) [SAW8WA2A-L35M40-CA](#) [SML013WBDW1](#) [SML522BUWT86](#) [SML-](#)
[LX0402IC-TR](#)