

1. Features and Benefits

- High accuracy relative pressure sensor
- Ratiometric analog output or digital SENT output with optional compensated $\pm 1^{\circ}\text{C}$ accurate NTC temperature information
- System in a package: MEMS, analog front end circuitry, 16 bit microcontroller, analog back end circuitry, voltage regulators
- Large automotive temperature range (-40°C to 150°C)
- Automotive qualified and automotive diagnostic features (clamping levels, broken track diagnostics, multiple internal fault diagnostics)
- Factory calibrated or fully programmable or reconfigurable through the connector for customized calibration curves
- Back side exposed relative pressure sensor for higher resistance to common automotive media
- Assembled in a robust easy to seal package

2. Application Examples

- Fuel vapor pressure sensor
- Crankcase ventilation pressure sensor
- Pressure sensor for filter monitoring

3. Ordering Information

Product Code	Temperature Code	Package Code	Option Code	Packing Form Code
MLX90821	L	XG	DBA-003	RE
MLX90821	L	XG	DBA-005	RE
MLX90821	L	XG	DBA-006	RE
MLX90821	L	XG	DBA-007	RE
MLX90821	V	XG	DBA-008	RE
MLX90821	L	XG	DBA-100	RE

Legend:

Temperature Code: L = -40°C to 150°C
V = -40°C to 115°C

Package Code: XG = SOIC16 WB cavity package

Option Code: DBA-003 = -0.06 to 0.26bar relative pressure / 0.5V to 4.5V analog output
DBA-005 = -0.05 to 0.05bar relative pressure / 0.5V to 4.5V analog output
DBA-006 = -0.2 to 0.5bar relative pressure / 4.5V to 0.5V analog output
DBA-007 = -0.1 to 0.1bar relative pressure / 0.5V to 4.5V analog output
DBA-008 = -0.0375 to 0.0125bar relative pressure / 4.5V to 0.5V analog output
DBA-100 = -0.06 to 0.26bar relative pressure / 193 to 3896LSB SENT output

Packing Form: RE = Reel

Ordering example: MLX90821XG-DBA-003-RE

4. Functional Diagram

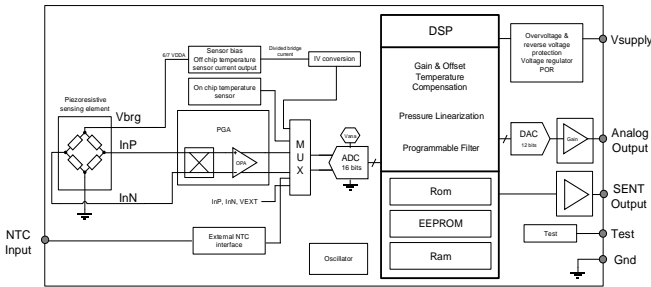

Figure 1: Functional block diagram

5. General Description

The MLX90821 is a packaged, factory calibrated, relative pressure sensor delivering a ratiometric analog output or a digital signal using the SENT protocol.

Using a best in class MEMS sensor enables reliably and accurately measuring very low pressures of a few tenths of millibars. An optimized architecture and a high density CMOS technology imparts the MLX90821 with best in class automotive EMC performance. A DSP based architecture using a 16bit microcontroller provides outstanding performance in terms of initial accuracy of both pressure and optionally external NTC temperature.

A smart package and die assembly concept suits applications with stringent automotive temperature and stress conditions needing small drift over life.

Contents

1. Features and Benefits	1
2. Application Examples	1
3. Ordering Information	1
4. Functional Diagram	2
5. General Description	2
6. Glossary of Terms	5
7. Absolute Maximum Ratings	5
8. Pin Definitions and Descriptions	6
9. General Electrical Specifications	7
10. Detailed General Description	8
11. Default programmed settings	10
11.1. Default Characteristics DBA-003	13
11.2. Default Characteristics DBA-005	13
11.3. Default Characteristics DBA-006	14
11.4. Default Characteristics DBA-007	14
11.5. Default Characteristics DBA-008	15
11.6. Default Characteristics DBA-100	16
12. Filters	17
12.1. PFLT	17
12.2. SSF	17
13. Analog Front End	18
14. ADC	20
15. Digital	20
16. NTC Temperature Linearization	21
17. SENT Configuration	23
17.1. Fast Channel Configuration	23
17.2. Slow Channel Configuration	23
18. Wrong Connections Overview Analog Output	28
19. Wrong Connections Overview SENT Output	29
20. Diagnostics	30
20.1. Input Diagnostics	30

MLX90821

Relative Pressure Sensor IC

20.2. Diagnostic Sources	30
20.3. Sent Output Fast and Slow Channel Diagnostics.....	31
21. SENT Timings	36
22. Application Information	37
23. Standard information regarding manufacturability of Melexis products with different soldering processes.....	38
24. ESD Precautions.....	38
25. Package Information	39
26. Contact.....	40
27. Disclaimer.....	40

6. Glossary of Terms

Bar: Pressure unit (1bar = 100kPa)
POR: Power-on Reset
ADC: Analog to Digital Converter
DAC: Digital to Analog Converter
DSP: Digital Signal Processor
EMC: Electro Magnetic Compatibility
Vbrg: Sensor bridge supply
InP: Positive sensing element input
InN: Negative sensing element input
OV: Over Voltage
UV: Under Voltage
SENT: Single Edge Nibble Transmission
FC: SENT Fast Channel
FC1: SENT Fast Channel 1
FC2: SENT Fast Channel 2

7. Absolute Maximum Ratings

Parameter	Value	Units
Supply Voltage (overvoltage)	18	V
Reverse Voltage Protection	-14	V
Positive output voltage	18	V
Reverse output voltage	-0.5	V
Operating Temperature Range	-40 to 150	°C
Storage Temperature Range	-40 to 150	°C
Programming Temperature Range	-40 to 125	°C
Burst pressure (Room Temperature)	3.75	Bar

Table 1: Absolute maximum ratings

Exceeding the absolute maximum ratings may cause permanent damage. Exposure to absolute-maximum-rated conditions for extended periods may affect device reliability.

8. Pin Definitions and Descriptions

Pin number	Description	Pin number	Description
1	Not Connected	16	Not Connected
2	Not Connected	15	Not Connected
3	Not Connected	14	Not Connected
4	Not Connected	13	Not Connected
5	Ground	12	Test pin
6	NTC input	11	SENT output
7	Ground	10	Test pin
8	Analog output	9	Supply input

Table 2: Pin out definitions and descriptions

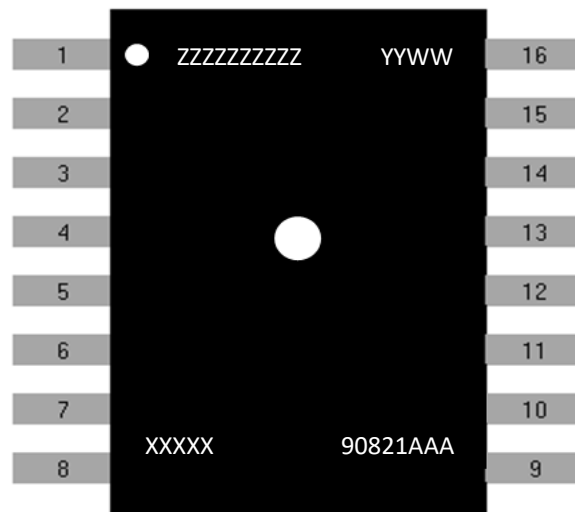

Figure 2: Package marking (top view)

Symbol	Function / Description
ZZZZZZZZZZ	Assembly lot number
YY	Year of assembly
WW	Calendar week of assembly
XXXXX	Sensor lot number
AAA	MEMS and ASIC traceability letter

Table 3: Package marking definition

9. General Electrical Specifications

DC Operating Parameters $T_A = -40^{\circ}\text{C}$ to 150°C

Parameter	Symbol	Remarks	Min	Typ ⁽¹⁾	Max	Units
Nominal supply voltage	Vdd		4.5	5	5.5	V
Nominal supply current	Idd	No output load connected, no NTC connected ⁽²⁾		8.5	11	mA
Decoupling capacitor on supply			47	100		nF
Capacitive load on analog output	Cload		47	100	470	nF
Resistive load on analog output	Rload	Pull up or Pull down	4.7			kOhm
Capacitive load on SENT output	Cload	Pure capacitive load			2.2	nF
		CRC load circuit (C close to device + Series R + C close to connector)			1.1nF + 220Ω + 1.1nF	
Resistive load on SENT output		Pull-up to Vdd at receiver ⁽³⁾	10		55	kOhm
Supply programming entry level	Vdd_com	Threshold to enter communication mode	6.2	7	7.8	V
Analog POR level (rising)			3.1	3.5	3.9	V
Analog POR hysteresis			100		500	mV
Digital POR level (rising)			2.05	2.3	2.7	V
Digital POR hysteresis			10		200	mV
Analog regulator	VDDA		-9%	3.5	+9%	V
Nominal bridge supply voltage	Vbrg		-9%	3	+9%	V
Sensing element sensitivity				55		mV/V/bar
ADC resolution				16		Bits
Diagnostic limits	Diag low	Pull-up $\geq 4.7\text{k}\Omega$ Pull-down $\geq 4.7\text{k}\Omega$			3 3	%Vdd
	Diag high	Pull-up $\geq 4.7\text{k}\Omega$ Pull-down $\geq 8\text{k}\Omega$	96 96			%Vdd
Clamping levels analog output	Clamp low	Programmable range with 7 bit resolution for the low clamping level, 9 for the high	0		12.5	%Vdd
	Clamp high		50		100	%Vdd

¹ Typical values are defined at $T_A = +25^{\circ}\text{C}$ and $V_{DD} = 5\text{V}$.

² Only applicable for SENT output and combination with NTC option.

³ As specified in the SENT standard

Parameter	Symbol	Remarks	Min	Typ ⁽¹⁾	Max	Units
Analog saturation output level	Vsat high	Pull-up $\geq 4.7k\Omega$ Pull-down $\geq 4.7k\Omega$ Pull-down $\geq 10k\Omega$	97 96 97		100 100 100	%Vdd
	Vsat low	Pull-up $\geq 4.7k\Omega$ Pull-down $\geq 4.7k\Omega$	0 0		3 3	%Vdd
Power up time analog		Time from reaching minimum allowed supply voltage of 4.5V till having the output within specification			1.3	ms
Power up time SENT		Time from reaching minimum allowed supply voltage of 4.5V till the first falling edge of the first SENT frame			1.1	ms
Pressure response time analog		Time needed for the output to change from an input pressure step to 90% of its final value. Capacitive load 100nF. Using default filter settings PFLT=0 and SSF=1. For response times using different filter settings see Table 11.			1	ms
Pressure response time SENT ⁽⁴⁾		Default filter setting PFLT = 0 and SSF = 1. Tick time = 3 μ s and Pause Pulse enabled. For other configurations refer to Table 11 in chapter 12.1.			3	SENT frames
InP InN digital diagnostic levels		Diagnostic thresholds of 25% of VDDA (low) and 75% of VDDA (high)	-16384		16384	lsb
Pressure output noise analog		BW limited to 50kHz.			2	mVrms
Input voltage range on NTC pin			0		3.5	V

Table 4: Electrical specifications

10. Detailed General Description

The MLX90821 contains a pressure sensing element which consists of a square diaphragm realized in the silicon chip by backside etching. The diaphragm reacts to a pressure difference between the top and bottom side of the diaphragm. The internal strain increases, in particular at the border of the diaphragm. Here, the piezoresistive elements have been implanted into the silicon diaphragm, which act as a transducer.

The sensor interface containing the readout circuit is integrated in the same package as the sensing element. The electronics front end amplifies the signal from the bridge, performs a coarse offset compensation and an ADC conversion. The DSP performs the compensations over temperature. Furthermore, the digital circuit provides some filtering, the possibility to linearize the pressure signal and also implements the clamping function. The analog back end consists of a 12 bit DAC and an output driver. This chip delivers an analog output proportional to the pressure or a SENT output compliant with the rev 4 from April 2016 of the SAE J2716 specification. An accurate factory calibrated external NTC temperature is also available on the SENT output.

⁴ Number of SENT frames between pressure step and settled output (last frame containing stable pressure data)

MLX90821

Relative Pressure Sensor IC

A broken wire detection block allows actively driving the output to one of the rails in case of a broken supply or ground connection. Extensive protection of the supply lines allows the MLX90821 to handle extreme overvoltage conditions and is immune to severe external disturbances. Several diagnostic functions (over-voltage, under-voltage, overpressure, under pressure detections) have been implemented on the 90821 and can be enabled by programming EEPROM settings. Figure 3 describes MLX90821 block diagram.

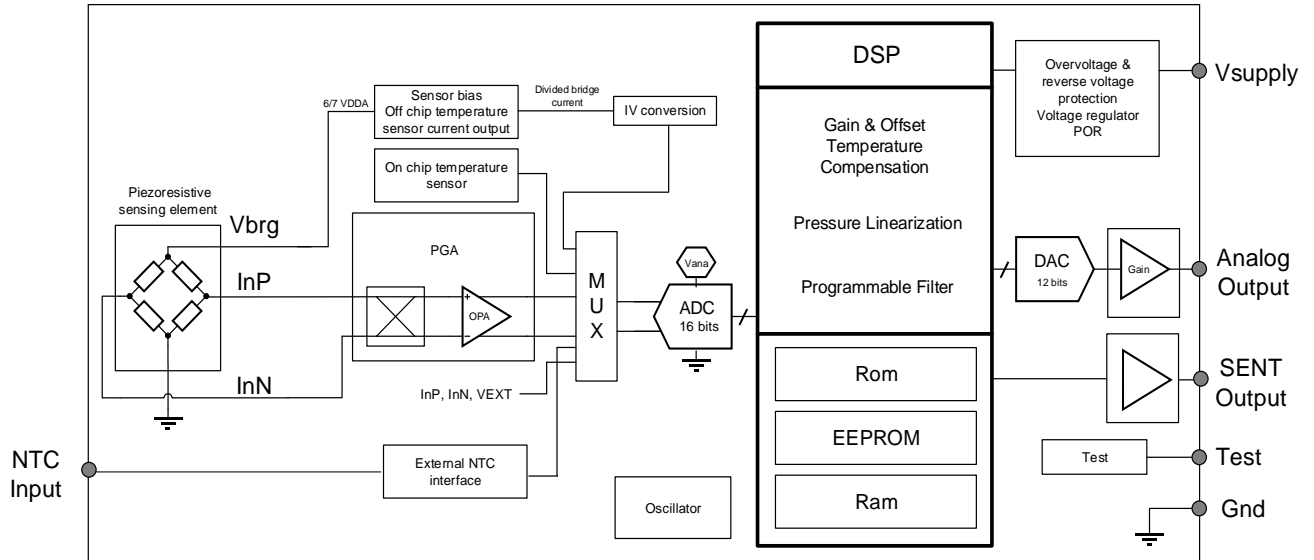

Figure 3: MLX90821 block diagram

11. Default programmed settings

The MLX90821 is calibrated at the final manufacturing test step. During the calibration, settings are stored in the on chip EEPROM to define the pressure transfer curve as well as the output clamping levels. On MLX90821 devices using the SENT output, besides pressure, the internal temperature and optionally the NTC temperature calibrations are performed. Together with the transfer functions, the IC filter values are set.

The analog output transfer curves as described below are valid assuming a supply voltage of 5V for the IC, the analog output scales in a ratiometric way to the supply voltage.

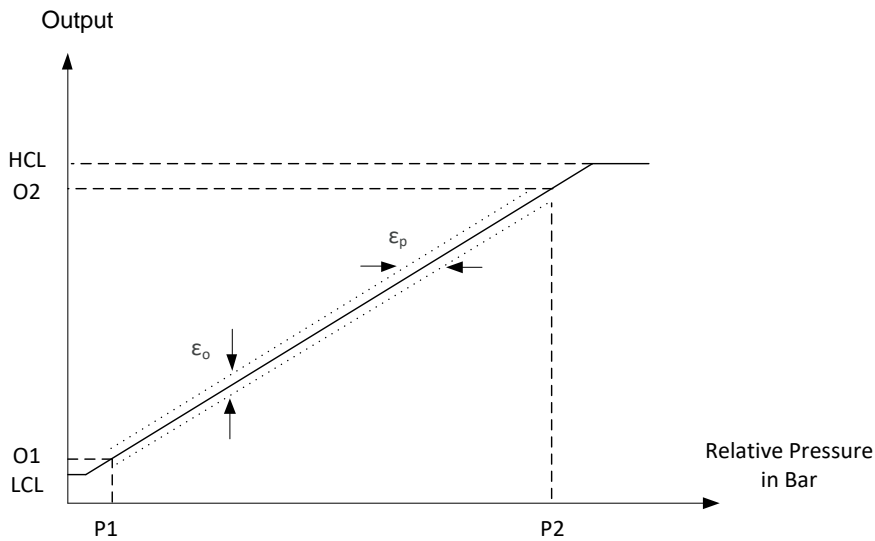

Figure 4: Pressure transfer function description at room temperature

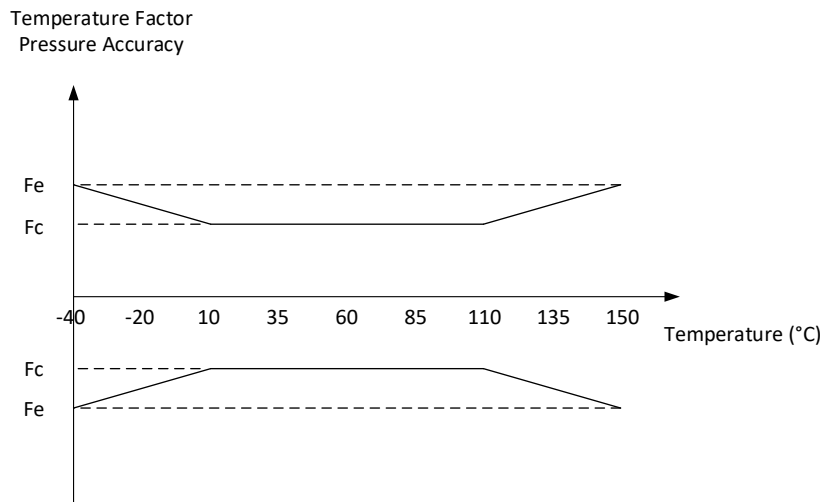

Figure 5: Pressure accuracy temperature factor (temperature code L)

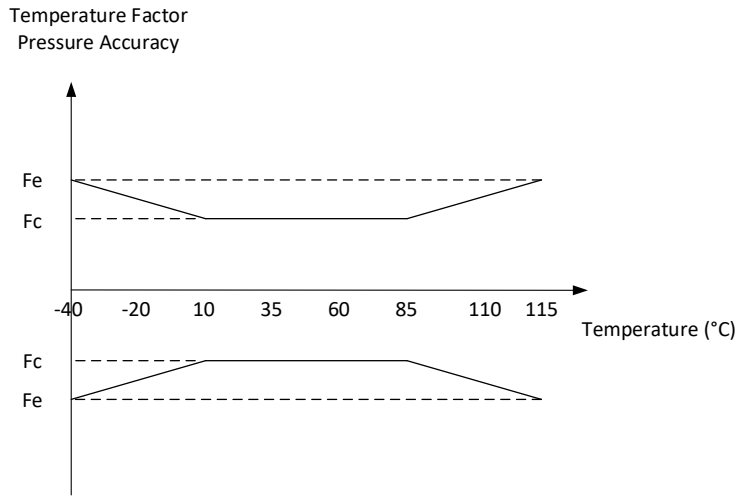

Figure 6: Pressure accuracy temperature factor (temperature code V)

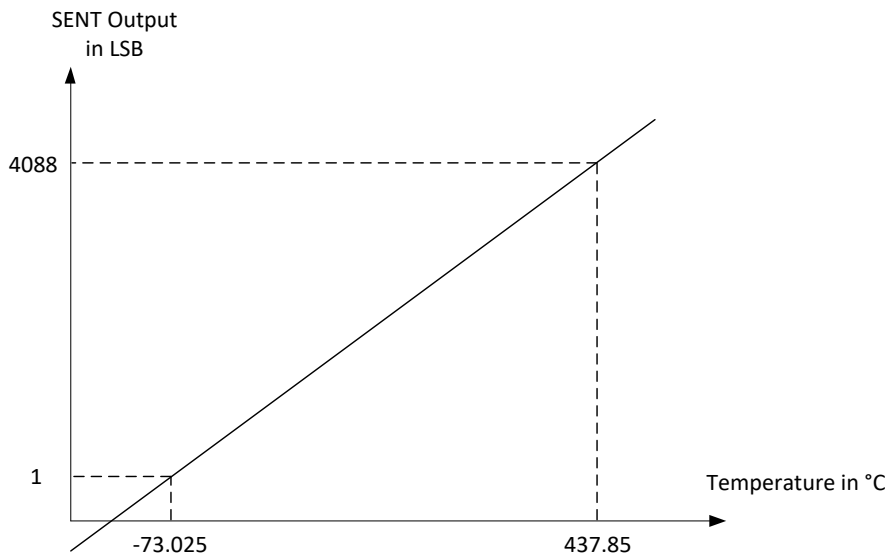

Figure 7: NTC and internal temperature transfer function

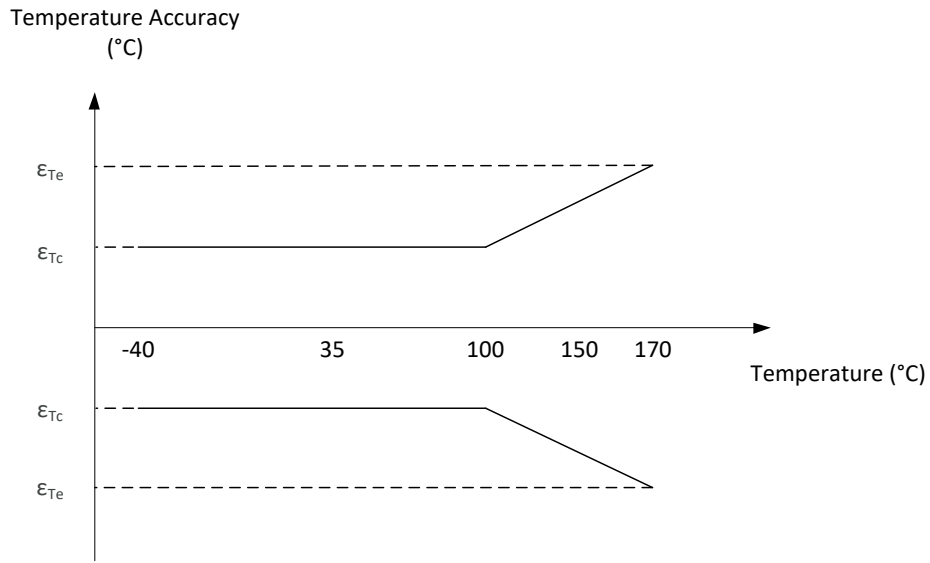

Figure 8: NTC temperature accuracy

11.1. Default Characteristics DBA-003

Transfer Curve Parameter	Symbol	Remarks	Value			Unit
Pressure 1	P1	See Figure 4: Pressure transfer function description at room temperature	-0.06			Bar
Pressure 2	P2		0.26			Bar
Output 1	O1		0.5			V
Output 2	O2		4.5			V
Low clamping level	LCL		0.25			V
High clamping level	HCL		4.75			V
Pressure Accuracy Parameter	Symbol	Remarks	Min	Typ	Max	Unit
Output accuracy	ϵ_o	Overall accuracy expressed as output value (FS range from 0.5V to 4.5V)	-60 -1.5		60 1.5	mV %FS
Pressure accuracy	ϵ_p	Overall accuracy expressed as pressure value	-4.8		4.8	mBar
Center temperature accuracy factor	Fc	See Figure 5: Pressure accuracy temperature factor			1	
Extended temperature accuracy factor	Fe				1.5	

Table 5: DBA-003 Default configuration

11.2. Default Characteristics DBA-005

Transfer Curve Parameter	Symbol	Remarks	Value			Unit
Pressure 1	P1	See Figure 4: Pressure transfer function description at room temperature	-0.05			Bar
Pressure 2	P2		0.05			Bar
Output 1	O1		0.5			V
Output 2	O2		4.5			V
Low clamping level	LCL		0.5			V
High clamping level	HCL		4.5			V
Pressure Accuracy Parameter	Symbol	Remarks	Min	Typ	Max	Unit
Output accuracy	ϵ_o	Overall accuracy expressed as output value (FS range from 0.5V to 4.5V)	-100 -2.5		100 2.5	mV %FS
Pressure accuracy	ϵ_p	Overall accuracy expressed as pressure value	-2.5		2.5	mBar
Center temperature accuracy factor	Fc	See Figure 5: Pressure accuracy temperature factor			1	
Extended temperature accuracy factor	Fe				1.5	

Table 6: DBA-005 Default configuration

11.3. Default Characteristics DBA-006

Transfer Curve Parameter	Symbol	Remarks	Value			Unit
Pressure 1	P1	See Figure 4: Pressure transfer function description at room temperature	-0.2			Bar
Pressure 2	P2		0.5			Bar
Output 1	O1		4.5			V
Output 2	O2		0.5			V
Low clamping level	LCL		0.3			V
High clamping level	HCL		4.7			V
Pressure Accuracy Parameter	Symbol	Remarks	Min	Typ	Max	Unit
Output accuracy	ϵ_o	Overall accuracy expressed as output value (FS range from 0.5V to 4.5V)	-40 -1		40 1	mV %FS
Pressure accuracy	ϵ_p	Overall accuracy expressed as pressure value	-7		7	mBar
Center temperature accuracy factor	Fc	See Figure 5: Pressure accuracy temperature factor			1	
Extended temperature accuracy factor	Fe				1.5	

Table 7: DBA-006 Default configuration

11.4. Default Characteristics DBA-007

Transfer Curve Parameter	Symbol	Remarks	Value			Unit
Pressure 1	P1	See Figure 4: Pressure transfer function description at room temperature	-0.1			Bar
Pressure 2	P2		0.1			Bar
Output 1	O1		0.5			V
Output 2	O2		4.5			V
Low clamping level	LCL		0.475			V
High clamping level	HCL		4.8			V
Pressure Accuracy Parameter	Symbol	Remarks	Min	Typ	Max	Unit
Output accuracy	ϵ_o	Overall accuracy expressed as output value (FS range from 0.5V to 4.5V)	-90 -2.25		90 2.25	mV %FS
Pressure accuracy	ϵ_p	Overall accuracy expressed as pressure value	-4.5		4.5	mBar
Center temperature accuracy factor	Fc	See Figure 5: Pressure accuracy temperature factor			1	
Extended temperature accuracy factor	Fe				1.5	

Table 8: DBA-007 Default configuration

11.5. Default Characteristics DBA-008

Transfer Curve Parameter	Symbol	Remarks	Value			Unit
Pressure 1	P1	See Figure 4: Pressure transfer function description at room temperature	-0.0375			Bar
Pressure 2	P2		0.0125			Bar
Output 1	O1		4.5			V
Output 2	O2		0.5			V
Low clamping level	LCL		0.3			V
High clamping level	HCL		4.7			V
Pressure Accuracy Parameter	Symbol	Remarks	Min	Typ	Max	Unit
Output accuracy	ϵ_o	Overall accuracy expressed as output value (FS range from 0.5V to 4.5V)	-160 -4		160 4	mV %FS
Pressure accuracy	ϵ_p	Overall accuracy expressed as pressure value	-2		2	mBar
Center temperature accuracy factor	Fc	See Figure 6: Pressure accuracy temperature factor (temperature code V)			1	
Extended temperature accuracy factor	Fe				1.5	

Table 9: DBA-008 Default configuration

11.6. Default Characteristics DBA-100

Transfer Curve Parameter	Symbol	Remarks	Value			Unit
Pressure 1	P1	See Figure 4: Pressure transfer function description at room temperature	-0.06			Bar
Pressure 2	P2		0.26			Bar
Output 1	O1		193			LSB
Output 2	O2		3896			LSB
Low clamping level	LCL		1			LSB
High clamping level	HCL		4088			LSB
Pressure Accuracy Parameter	Symbol	Remarks	Min	Typ	Max	Unit
Output accuracy	ϵ_o	Overall accuracy expressed as output value (FS range from 193 to 3896)	-55 -1.5		55 1.5	LSB %FS
Pressure accuracy	ϵ_p	Overall accuracy expressed as pressure value	-4.8		4.8	mBar
Center temperature accuracy factor	Fc	See Figure 5: Pressure accuracy temperature factor			1	
Extended temperature accuracy factor	Fe				1.5	

Table 10: DBA-100 Default configuration

12. Filters

There are two filters available to filter the pressure signal. The first filter is a Small Signal Filter which can be disabled or enabled. The second filter is a first order low pass filter for the pressure signal which has a programmable depth.

12.1. PFLT

PFLT is a programmable first order low pass filter. The depth of this filter can be selected. This filter can be configured to select the optimal trade-off between response time and output noise.

The low pass filter is implemented according to the following formula:

$$Filter_{output}(k) = \frac{Filter_{input}(k) - Filter_{output}(k - 1)}{2^{PFLT}} + Filter_{output}(k - 1)$$

The PFLT parameter in the formula is set in EEPROM and can have a value between 0 and 9. An overview of typical response times when applying a step on the input using different PFLT filter settings can be found in Table 11. Filter setting 0 disables the PFLT.

PFLT setting	Analog output Response time in ms ⁽⁵⁾	SENT output Response time in SENT frames ⁽⁶⁾
0	0.93	3
1	1.25	3
2	2	5
3	3.7	8
4	7.1	13
5	13.7	24
6	27.0	45
7	53.8	88
8	106.8	176
9	203.8	350

Table 11: Filter settings and typical response times

12.2. SSF

The SSF (Small Signal Filter) is a digital filter which is designed not to have an impact on the response time of a fast changing pressure signal like a pressure step. When a large signal change at the input is present, the filter is bypassed and not filtering the signal. For small signal changes, which are in most cases noise, the filter is used and filtering the pressure signal.

The Small Signal Filter can be enabled or disabled in EEPROM. It is advised not to use the SSF in combination with the PFLT enabled.

⁵ Time needed for the output to change from an input pressure step to 90% of its final value.

⁶ Tick time is set to 3us and Pause Pulse is enabled.

13. Analog Front End

The analog front end of the MLX90821 consists of a chopping stage and 3 amplification stages as can be seen in Figure 9. There are also several input diagnostics integrated into this front end to be able to detect a broken InP or InN connection or an input which is out of range. This diagnostic information is transferred to the microcontroller to handle further action for example flagging a diagnostic message.

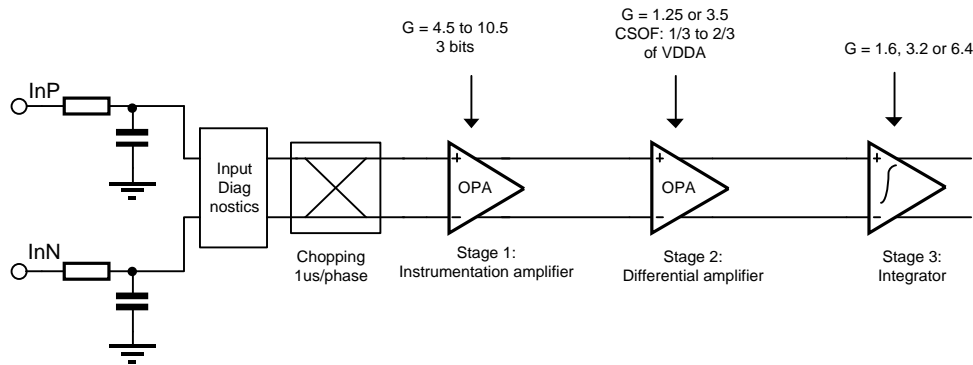

Figure 9: Analog front end block diagram

The first stage is an instrumentation amplifier of which the gain can be programmed using 3 bits to cover a gain range between 4.5 and 10.6.

Transfer equation:

$$\text{OUTP1} - \text{OUTN1} = \text{Gst1} * (\text{InP} - \text{InN}) \text{ in phase 1}$$

$$\text{OUTP1} - \text{OUTN1} = \text{Gst1} * (\text{InN} - \text{InP}) \text{ in phase 2}$$

The second stage is a fully differential amplifier. The gain of the amplifier can be calibrated using 1 bit.

Transfer equation:

$$\text{OUTP2} - \text{OUTN2} = -\text{Gst2} * (\text{OUTP1} - \text{OUTN1}) - \text{Gst2} * (\text{CSOF1} - \text{CSOF2}) \text{ in phase 1}$$

$$\text{OUTP2} - \text{OUTN2} = -\text{Gst2} * (\text{OUTN1} - \text{OUTP1}) - \text{Gst2} * (\text{CSOF2} - \text{CSOF1}) \text{ in phase 2}$$

The CSOF1 and CSOF2 signals are generated by the coarse offset DAC with the following transfer functions:

$$\text{CSOF1} = \frac{\text{VDDA}}{2} + (-1)^{\text{CO7}} * \left(\frac{2}{3} - \frac{1}{3} \right) * \frac{\text{VDDA}}{2} * \frac{\text{CO}[6:0]}{127}$$

$$\text{CSOF2} = \frac{\text{VDDA}}{2} - (-1)^{\text{CO7}} * \left(\frac{2}{3} - \frac{1}{3} \right) * \frac{\text{VDDA}}{2} * \frac{\text{CO}[6:0]}{127}$$

CO[6:0] fixes the DAC output. CO7 is used for the polarity.

The third stage is an integrator which is controlled using 2 bits to set a gain between 1.6 and 6.4

Transfer equation at the outputs of the amplifier:

$$\text{OUTP3} - \text{OUTN3} = -N * (\text{C1}/\text{C2}) * (\text{OUTP2} - \text{OUTN2})$$

$$\text{OUTP3_common_mode} \text{ and } \text{OUTN3_common_mode} = \text{VCM} = \text{VDDA}/2$$

In this equation N represents the number of integration cycles which is a fixed value of N = 40.

C2 is a fixed feedback capacitor of approximately 5pF. C1 can have 3 different values: 0.2pF, 0.4pF or 0.8pF.

Transfer equation after the ADC:

$$\text{Pressure_ADC} = ((\text{OUTN3} - \text{OUTP3}) * 2^{16} / \text{VDDA}) + 32768$$

An overview of all possible values for Gst1, Gst2 and Gst3 can be found in Table 12 below.
The input stage is designed to work with an input common-mode voltage range between 42%Vbrg and 58%Vbrg.

Gain setting [-]	Gst1 [V/V]	Gst2 [V/V]	Gst3 [V/V]	Total gain [V/V]	FS Differential input signal [mV]
0	4.49	-1.25	1.6	-9.0	± 195
1	5.06	-1.25	1.6	-10.1	± 173
2	5.8	-1.25	1.6	-11.6	± 151
3	6.52	-1.25	1.6	-13.0	± 134
4	7.43	-1.25	1.6	-14.9	± 118
5	8.37	-1.25	1.6	-16.7	± 105
6	9.35	-1.25	1.6	-18.7	± 94
7	10.6	-1.25	1.6	-21.2	± 83
8	4.49	-3.5	1.6	-25.1	± 70
9	5.06	-3.5	1.6	-28.3	± 62
10	5.8	-3.5	1.6	-32.5	± 54
11	6.52	-3.5	1.6	-36.5	± 48
12	7.43	-3.5	1.6	-41.6	± 42
13	8.37	-3.5	1.6	-46.9	± 37
14	9.35	-3.5	1.6	-52.4	± 33
15	10.6	-3.5	1.6	-59.4	± 29
16	4.49	-3.5	3.2	-50.3	± 35
17	5.06	-3.5	3.2	-56.7	± 31
18	5.8	-3.5	3.2	-65.0	± 27
19	6.52	-3.5	3.2	-73.0	± 24
20	7.43	-3.5	3.2	-83.2	± 21
21	8.37	-3.5	3.2	-93.7	± 19
22	9.35	-3.5	3.2	-104.7	± 17
23	10.6	-3.5	3.2	-118.7	± 15
24	4.49	-3.5	6.4	-100.6	± 17
25	5.06	-3.5	6.4	-113.3	± 15
26	5.8	-3.5	6.4	-129.9	± 13
27	6.52	-3.5	6.4	-146.0	± 12
28	7.43	-3.5	6.4	-166.4	± 11
29	8.37	-3.5	6.4	-187.5	± 9
30	9.35	-3.5	6.4	-209.4	± 8
31	10.6	-3.5	6.4	-237.4	± 7

Table 12: Gain and input signal range of the analog front end

14. ADC

The 16 bit differential ADC has a range from $-VDDA/2$ to $+VDDA/2$.

There are 7 different ADC channels. Channel 0 is not used. Table 13 below describes all the channels.

ADC	Signal	Remarks
SIN[2:0]		
0	-	Nothing connected
1	P	Pressure
2	Tint	Internal Temperature
3	Vsup	External Supply
4	InP/InN	Multiplexing between Positive/Negative Sensor Output
5	Vdig	Digital Regulator
6	Tntc	NTC Output
7	Text	External Temperature

Table 13: ADC channels

The different channels are converted in a constantly repeating sequence. A new ADC conversion is done every 50us following the sequence shown below in Figure 10. This is resulting in an updated pressure output value every 200us.



Figure 10: ADC sequence

15. Digital

The digital is built around a 16-bit microcontroller. It contains besides the processor also ROM, RAM and EEPROM and a set of user and system IO registers.

Temperature compensation of the pressure signal and pressure linearization is handled by the microcontroller. For the pressure compensation there are EEPROM parameters allocated to be able to cover a large variety of calibration approaches.

Both for gain and offset of the pressure signal, there is a separate temperature dependency programmable ranging from a temperature independence to a first order, second order and finally a third order compensation. This is reflected in EEPROM parameters for the offset (O0, O1, O2 and O3) and for the gain (G0, G1, G2 and G3). If required, the linearity of the pressure signal can also be compensated without a temperature dependency or with a first order temperature dependency through EEPROM parameters L0 and L1.

Linearization of the NTC temperature is also covered partially by the microcontroller. More information in this topic can be found in chapter 16.

16. NTC Temperature Linearization

The linearization of the NTC temperature signal is split up in several stages. A schematic overview of these steps can be seen in Figure 11.

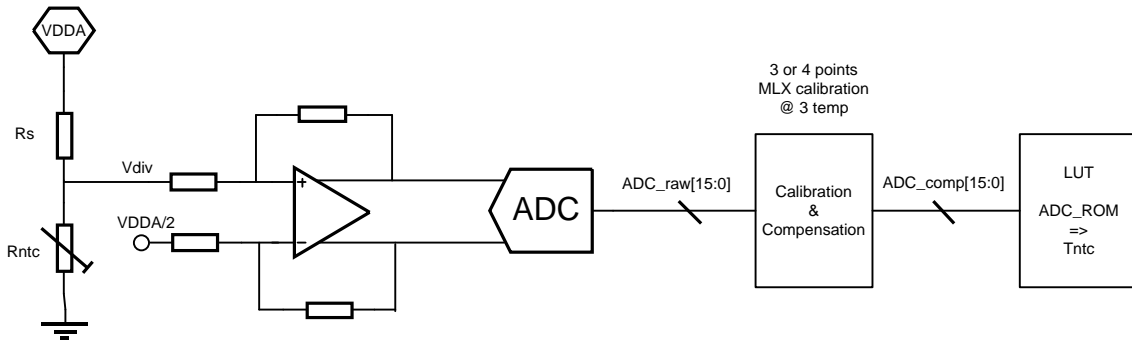

Figure 11: Block diagram NTC linearization

The complete system can be divided into 5 separate stages.

1. A resistor divider with internal resistor R_s is used to linearize R_{ntc} into a voltage.
2. A fully differential amplifier with unity gain is used to drive the ADC.
3. The 16-bit ADC is being used to convert the analog resistor divider output voltage into a digital signal called ADC_raw .
4. With the help of calibration data saved in EEPROM the microcontroller will perform a first compensation on ADC_raw converting in to ADC_comp . This new value is targeted to be as close as possible to the value ADC_ROM .
5. Finally a look up table (LUT) will be used to convert the ADC_ROM values into the T_{ntc} value which is the desired linearized NTC temperature.

The default optional NTC characteristic can be found in Table 14. When using an NTC which does not match the coefficients described above, it is advised to contact Melexis.

The EEPROM coefficients which are used for the conversion from ADC_raw to ADC_comp are N_0 to N_3 , $N_0_Diff_Low$ to $N_3_Diff_Low$, $N_0_Diff_High$ to $N_3_Diff_High$ and $TEMP1$ to $TEMP3$.

T (°C)	R _T /R ₂₅	R (Ω)	T (°C)	R _T /R ₂₅	R (Ω)
-55	53.68	268400	75	0.18779	938.95
-50	39.112	195560	80	0.16261	813.05
-45	28.817	144085	85	0.14131	706.55
-40	21.459	107295	90	0.12324	616.2
-35	16.142	80710	95	0.10783	539.15
-30	12.259	61295	100	0.094663	473.315
-25	9.3959	46979.5	105	0.083361	416.805
-20	7.2644	36322	110	0.073638	368.19
-15	5.6633	28316.5	115	0.06524	326.2
-10	4.4503	22251.5	120	0.057964	289.82
-5	3.5236	17618	125	0.05164	258.2
0	2.8102	14051	130	0.046128	230.64
5	2.2567	11283.5	135	0.041309	206.545
10	1.8243	9121.5	140	0.037085	185.425
15	1.4841	7420.5	145	0.033373	166.865
20	1.2147	6073.5	150	0.030102	150.51
25	1	5000	155	0.027213	136.065
30	0.82785	4139.25	160	0.024654	123.27
35	0.689	3445	165	0.022384	111.92
40	0.57639	2881.95	170	0.020364	101.82
45	0.48457	2422.85	175	0.018564	92.82
50	0.40931	2046.55	180	0.016955	84.775
55	0.34731	1736.55	185	0.015515	77.575
60	0.29599	1479.95	190	0.014223	71.115
65	0.25332	1266.6	195	0.013063	65.315
70	0.21768	1088.4	200	0.012017	60.085

Table 14: Default NTC characteristic

17. SENT Configuration

The SENT output is designed to be compliant with the SAE J2716 rev. Apr 2016 SENT standard. The tick time is configurable in EEPROM using parameter TICK_DIV. The available tick time settings are 3us, 4us, 6us, 10us, 12us and 16us. A pause pulse can also be enabled to have a fixed frame length of 282 ticks. This can be done using parameter PAUSE. The default configuration for option code DBA-100 is 3us tick time and pause pulse enabled.

17.1. Fast Channel Configuration

On the fast channel, 8 different options are available to configure channel 1 and channel 2. An overview of these different options and how to configure them can be found in Table 15.

#	FC_CFG setting	Fast Channel 1	Fast Channel 2	Remark
1	0	Pressure (3x 4 bit)	Inverse of Pressure (3x 4 bit)	
2	1	Pressure (3x 4 bit)	Rolling counter (2x 4 bit) and inverse of MSN of Pressure (1x 4 bit)	Default for option code DBA-100.
3	2	Pressure (3x 4 bit)	Medium temperature (3x 4 bit)	Media temperature can either be NTC or sensing element temperature. (Tmedium_Select).
4	3	Pressure (3x 4 bit)	Internal temperature (3x 4 bit)	Internal temperature can either be PTAT or sensing element temperature (Tinternal_Select).
5	4	Pressure only (3x 4 bit)	/	
6	5	Pressure only (4x 3 bit)	/	
7	6	Data indicated by pointer 1 (3x 4 bit)	Data indicated by pointer 2 (3x 4 bit)	In this mode no diagnostics are available. FC configuration only used by Melexis.
8	7	Pressure (3x 4 bit)	0 (3x 4 bit)	

Table 15: Fast channel configuration options

The selection of the fast channel output mode can be done by changing the parameter 'FC_CFG' in the EEPROM.

In case Medium temperature is selected to be available on fast channel 2, the type of media can be defined in EEPROM using parameter 'Tmedium_Select'. When selecting 0, linearized NTC temperature will be available. Selecting 1 enables sensing element temperature. Sensing element temperature is not calibrated by default.

For Internal temperature, also two options are available defined in EEPROM parameter 'Tinternal_Select' where 0 corresponds to on chip factory calibrated PTAT temperature and 1 corresponds to sensing element temperature. The same comment regarding the calibration of the sensing element temperature calibration as made above applies here.

17.2. Slow Channel Configuration

The Slow Serial Channel is implemented according to the Enhanced Serial Message Format using 12 bit data and 8 bit message ID as described in the reference SENT protocol standard SAE J2716 rev. Apr 2016.

An overview of the different slow channel messages which are available in the MLX90821 can be found in Table 16. From this table 16 messages can be configured completely in EEPROM. The 12 bit data content of these messages can be configured freely. The ID of programmable message PR0, PR1, PR2 and PR3 is copied from EEPROM (2x 4 bit). The ID of PR5 is 1 bit higher than of PR4. The same is valid for the other pairs: PR6-7, PR8-9, ..., PR14-15. This programmable ID is indicated in Table 16 as 0xYZ.

All programmable messages can also be enabled and disabled, but not all independently of each other:

- PR0, PR1, PR2 and PR3 can be each independently enabled or disabled
- PR4 and PR5 are together enabled or disabled
- PR6 and PR7 are together enabled or disabled
- PR8, PR9, PR10 and PR11 are together enabled or disabled
- PR12, PR13, PR14 and PR15 are together enabled or disabled

#	Type	ID	Description	Data	Rep
0	RAM	0x01	Diagnostic codes	Error_flags (See chapter 20 Diagnostics)	Y
1	EEPROM	0x03	Sensor Type	Configurable 0 to 15	N
2	EEPROM	0x04	Configuration code	Configurable 0 to 4095	N
3	EEPROM	0x05	Manufacturer Code	Configurable 0 to 4095	N
4	RAM	0x06	SENT revision	Selectable by bit in EEPROM Data = 3 or 4	N
5	RAM	0x07	Fast channel 1 Characteristic X1	Fast channel 1 Characteristic Configuration Enable / disable shared with MID08	N
6	RAM	0x08	Fast channel 1 Characteristic X2	Fast channel 1 Characteristic Configuration Enable / disable shared with MID07	N
7	EEPROM	0xYZ	Fully Programmable message 0	Programmable ID: 8 bit Programmable Data: 12 bit	N
8	RAM	0x23	Internal Temperature	According to default linear temperature transfer characteristic in SAE J2716 standard	Y
9	RAM	0x09	Fast channel 1 Characteristic Y1	Fast channel 1 Characteristic Configuration Enable / disable shared with MID0A	N
10	RAM	0x0A	Fast channel 1 Characteristic Y2	Fast channel 1 Characteristic Configuration Enable / disable shared with MID09	N
11	ROM	0x0B	Fast channel 2 Characteristic X1	If FC2 is pressure (FC_CFG = 0): ID0B = ID07 If FC2 is temperature (FC_CFG = 2 or 3): Default temperature Characteristic X1: Fixed value: 233 Enable / disable shared with MID0C / 0D / 0E	N
12	ROM	0x0C	Fast channel 2 Characteristic X2	If FC2 is pressure (FC_CFG = 0): ID0C = ID08 If FC2 is temperature (FC_CFG = 2 or 3): Default temperature Characteristic X2: Fixed value: 423 Enable / disable shared with MID0B / 0D / 0E	N

#	Type	ID	Description	Data	Rep
13	ROM	0x0D	Fast channel 2 Characteristic Y1	If FC2 is pressure (FC_CFG = 0): ID0D = ID09 If FC2 is temperature (FC_CFG = 2 or 3): Default temperature Characteristic Y1: Fixed value: 264 Enable / disable shared with MID0B / 0C / 0E	N
14	ROM	0x0E	Fast channel 2 Characteristic Y2	If FC2 is pressure (FC_CFG = 0): ID0E = ID0A If FC2 is temperature (FC_CFG = 2 or 3): Default temperature Characteristic Y2: Fixed value: 1784 Enable / disable shared with MID0B / 0C / 0D	N
15	EEPROM	0x29	Sensor ID #1	Programmable Data: 12 bit Enable / disable shared with MID2A / 2B / 2C	N
16	EEPROM	0xYZ	Fully Programmable message 1	Programmable ID: 8 bit Programmable Data: 12 bit	N
17	EEPROM	0x2A	Sensor ID #2	Programmable Data: 12 bit Enable / disable shared with MID29 / 2B / 2C	N
18	EEPROM	0x2B	Sensor ID #3	Programmable Data: 12 bit Enable / disable shared with MID29 / 2A / 2C	N
19	EEPROM	0x2C	Sensor ID #4	Programmable Data: 12 bit Enable / disable shared with MID29 / 2A / 2B	N
20	EEPROM	0xYZ	Fully Programmable message 2	Programmable ID: 8 bit Programmable Data: 12 bit	N
21	EEPROM	0xYZ	Fully Programmable message 3	Programmable ID: 8 bit Programmable Data: 12 bit	N
22	EEPROM	0xYZ	Programmable message 4	Programmable ID: 8 bit Programmable Data: 12 bit Enable / disable shared with programmable message 5	N
23	EEPROM	0xYZ	Programmable message 5	Message ID = ID programmable message 4 + 1 Programmable Data: 12 bit Enable / disable shared with programmable message 4	N
24	EEPROM	0xYZ	Programmable message 6	Programmable ID: 8 bit Programmable Data: 12 bit Enable / disable shared with programmable message 7	N
25	EEPROM	0xYZ	Programmable message 7	Message ID = ID programmable message 6 + 1 Programmable Data: 12 bit Enable / disable shared with programmable message 6	N

#	Type	ID	Description	Data	Rep
26	EEPROM	0xYZ	Programmable message 8	Programmable ID: 8 bit Programmable Data: 12 bit Enable / disable shared with programmable messages 9 / 10 / 11	N
27	EEPROM	0xYZ	Programmable message 9	Message ID = ID programmable message 8 + 1 Programmable Data: 12 bit Enable / disable shared with programmable messages 8 / 10 / 11	N
28	EEPROM	0xYZ	Programmable message 10	Programmable ID: 8 bit Programmable Data: 12 bit Enable / disable shared with programmable messages 8 / 9 / 11	N
29	EEPROM	0xYZ	Programmable message 11	Message ID = ID programmable message 10 + 1 Programmable Data: 12 bit Enable / disable shared with programmable messages 8 / 9 / 10	N
30	EEPROM	0xYZ	Programmable message 12	Programmable ID: 8 bit Programmable Data: 12 bit Enable / disable shared with programmable messages 13 / 14 / 15	N
31	EEPROM	0xYZ	Programmable message 13	Message ID = ID programmable message 12 + 1 Programmable Data: 12 bit Enable / disable shared with programmable messages 12 / 14 / 15	N
32	EEPROM	0xYZ	Programmable message 14	Programmable ID: 8 bit Programmable Data: 12 bit Enable / disable shared with programmable messages 12 / 13 / 15	N
33	EEPROM	0xYZ	Programmable message 15	Message ID = ID programmable message 14 + 1 Programmable Data: 12 bit Enable / disable shared with programmable messages 12 / 13 / 14	N
34	RAM	0x10	Medium Temperature	According to default linear temperature transfer characteristic in SAE J2716 standard	Y
35	RAM	0xE1	Device start-up check	Start-up self-check result data	N

Table 16: Slow channel messages

Messages which have a “Y” in the column Rep of Table 16 can be selected to have a higher occurrence in the slow channel message sequence. Their repetition rate can be configured as indicated in Table 17.

The repeatable messages MID01h, MID10h and MID23h can be configured individually to have their own repetition rate. The repetition factor setting can be done in respectively “SENT_REP_FACT_ID_01”, “SENT_REP_FACT_ID_10” and “SENT_REP_FACT_ID_23”.

Repetition Factor Setting	Real Repetition Factor
0	Message repetition disabled
1	Message repeat every 2 messages
2	Message repeat every 3 messages
3	Message repeat every 4 messages
4	Message repeat every 5 messages
5	Message repeat every 6 messages
6	Message repeat every 7 messages
7	Message repeat every 8 messages
8	Message repeat every 9 messages
9	Message repeat every 10 messages
10	Message repeat every 12 messages
11	Message repeat every 16 messages
12	Message repeat every 20 messages
13	Message repeat every 24 messages
14	Message repeat every 28 messages
15	Message repeat every 30 messages

Table 17: Repetition rate settings

Once a message is configured to be repeatable, it will automatically have the highest priority. Therefore it will appear first in the slow message sequences.

The priority order between MID01, MID10 and MID23 can also be configured using EEPROM parameter “SC_R_O”:

- SC_R_O = 0: Priority order: ID01h > ID10h > ID23h
- SC_R_O = 1: Priority order: ID10h > ID23h > ID01h

18. Wrong Connections Overview Analog Output

Table 18 provides an overview of the behavior of the MLX90821 when different combinations of connections to GND, VDD and OUT are made.

GND	VDD	Analog out	Effect on output	Action after wrong connection
0V	5V	Pull-down or Pull-up	Normal operation	Normal operation
Disconnected	5V	Pull-down or Pull-up	High Fault Band	Normal operation
0V	Disconnected	Pull-down or Pull-up	Low Fault Band	Normal operation
0V	5V	Disconnected	Low Fault Band for Pull-down High Fault Band for Pull-up	Normal operation
0V	5V	0V	Low Fault Band	Normal operation
0V	5V	5V	High Fault Band	Normal operation
0V	5V	18V	18V	Normal operation
0V	0V	Pull-down or Pull-up	Low Fault Band	Normal operation
0V	18V	Pull-down or Pull-up	Low Fault Band for Pull-down High Fault Band for Pull-up	Normal operation
5V	5V	Pull-down or Pull-up	High Fault Band	Normal operation
5V	0V	Pull-down or Pull-up		Normal operation

Table 18: Wrong connections overview

19. Wrong Connections Overview SENT Output

Table 19 provides an overview of the behavior of the MLX90821 when different combinations of connections to GND, VDD and OUT are made.

GND	VDD	SENT out	Effect on output	Action after wrong connection
0V	5V	SAE Standard Load Circuit	Normal operation	Normal operation
Disconnected	5V	SAE Standard Load Circuit	No communication	Normal operation
0V	Disconnected	SAE Standard Load Circuit	No communication	Normal operation
0V	5V	Disconnected	No communication	Normal operation
0V	5V	0V	0V – No communication	Normal operation
0V	5V	5V	5V – No communication	Normal operation
0V	5V	18V	18V – No communication	Normal operation
0V	0V	SAE Standard Load Circuit	No communication	Normal operation
0V	18V	SAE Standard Load Circuit	No communication	Normal operation
5V	5V	SAE Standard Load Circuit	No communication	Normal operation
5V	0V	SAE Standard Load Circuit	No communication	Normal operation

Table 19: Wrong connections overview

20. Diagnostics

20.1. Input Diagnostics

An overview of the different input diagnostics conditions and their corresponding fault band and diagnostic source can be found in Table 20.

Condition	Analog Output Fault Band	SENT Output Fast Channel Code	Diagnostic Source ⁽⁷⁾
Vbrg disconnected	Low	4090	ERR_EN_SPSN
GND (sensor) disconnected	Low	4090	ERR_EN_SPSN
InP disconnected	Low	4090	ERR_EN_BW
InN disconnected	Low	4090	ERR_EN_BW
Vbrg shorted to GND	Low	4090	ERR_EN_SPSN
InP shorted to GND	Low	4090	ERR_EN_SPSN
InN shorted to GND	Low	4090	ERR_EN_SPSN
InP shorted to Vbrg	Low	4090	ERR_EN_SPSN
InN shorted to Vbrg	Low	4090	ERR_EN_SPSN

Table 20: Input diagnostics

20.2. Diagnostic Sources

The MLX90821 product has several internal checks which monitor the status of device. These checks or diagnostic sources can be enabled or disabled based on the sensor module requirements. An overview of the different diagnostic sources, their enable/disable parameter and the explanation of their functionality can be found below in Table 21. The default diagnostic configuration for the different option codes can be found in Table 22.

Bit	Parameter	Error condition
10	ERR_EN_TINT	The Internal temperature could not be measured/calculated
9	ERR_EN_IO	RAM configuration error
8	ERR_EN_SPSN	SP or SN pin voltage out of range
7	ERR_EN_PV	The pressure value could not be measured/calculated
6	ERR_EN_PP	Pressure parameter error
5	ERR_EN_BW	A broken wire is detected in the pressure sensor path
4	ERR_EN_TMED	The Medium temperature could not be measured/calculated
2	ERR_EN_VSUPH	The supply voltage is too high
1	ERR_EN_VSUPL	The supply voltage is too low
0	ERR_EN_TCHIP	The chip temperature out of range

Table 21: Diagnostic sources

⁷ See tables 22 to 24 for more information on the errors

Parameter	DBA-003	DBA-005	DBA-006	DBA-007	DBA-008	DBA-100
ERR_EN_TINT	x	x	x	x	x	x
ERR_EN_IO	✓	✓	✓	✓	✓	✓
ERR_EN_SPSN	✓	✓	✓	✓	✓	✓
ERR_EN_PV	✓	✓	✓	✓	✓	✓
ERR_EN_PP	✓	✓	✓	✓	✓	✓
ERR_EN_BW	✓	✓	✓	✓	✓	✓
ERR_EN_TMED	x	x	x	x	x	x
ERR_EN_VSUPH	x	x	x	x	x	x
ERR_EN_VSUPL	x	x	x	x	x	x
ERR_EN_TCHIP	✓	✓	✓	✓	✓	✓

Table 22: Default diagnostic configuration

The level of the over and under voltage diagnostics can be configured according to the ranges described in Table 23.

Parameter	Min	Max	Units	Comment
Under voltage detection threshold range	3.25	5.74	V	Optional and Programmable with 8 bits in parameter VSUP_LOW
Overvoltage detection threshold range	4.25	6.74	V	Optional and Programmable with 8 bits in parameter VSUP_HIGH
Over-/Under-voltage detection accuracy		200	mV	

Table 23: MLX90821 under and overvoltage detection

20.3. Sent Output Fast and Slow Channel Diagnostics

There are two values reserved to show an error diagnostic mode in the fast channel. These values are 4090 and 4091. According to the type of diagnostic flag, one of the values will be transmitted if enabled. Internal errors like for example PRESS_BROKEN_W or PRESS_PAR use 4090 to indicate an error condition on the fast channel. Errors conditions which can be linked to external influences can be configured to either transmit 4090 or 4091. These errors are VSUP_HIGH, VSUP_LOW and T_CHIP.

For both VSUP_HIGH and VSUP_LOW fast channel overwriting using an error message can even be disabled. This allows you to still decode properly the pressure or optionally temperature information in case of an over voltage or under voltage condition. The OV or UV condition can still be monitored using the status bits for FC1 and FC2 and the slow channel diagnostic message MID01.

An overview of the fast channel error configuration can be found in Table 24. The EEPROM parameters V_ERR, FCE_VSUP and FCE_TCHIP handle this configuration.

Fast Channel	Parameter		Fast Channel	Parameter
ERR_VSUP	V_ERR	FCE_VSUP	ERR_TCH	FCE_TCHIP
No change	0	Not applicable	4091	0
4091	1	0	4090	1
4090	1	1		

Table 24: Fast channel error configuration

MLX90821

Relative Pressure Sensor IC

The diagnostic slow channel message (MID 1) can be enabled or disabled independent of the other slow channel messages and it has an adjustable repetition factor (2, 4, .., 30).

More information on the different diagnostics shown in SENT, their fast channel, slow channel and status bit mapping can be found in the tables below.

Multiple diagnostic errors can be flagged in the range 8xxh – FFFh in case parameter DIAG_INT is set to 0.

MLX90821

Relative Pressure Sensor IC



ERROR_ENABLE parameter	ERROR	FC_CFG = 0				FC_CFG = 1				FC_CFG = 2			
		FC1	FC2	St[0]	St[1]	FC1	FC2	St[0]	St[1]	FC1	FC2	St[0]	St[1]
N.A.	no error	P	~P	0	0	P	cnt & ~MSN(P)	0	0	P	Tmed	0	0
-	not calibrated	4095	4095	1	1	4095	nc	1	nc	4095	4095	1	1
DIAG_INT	initialization error	4090	4090	1	1	4090	nc	1	nc	4090	4090	1	1
ERR_EN_TINT	T_INT	nc	nc	nc	nc	nc	nc	nc	nc	nc	nc	nc	nc
ERR_EN_IO	RAM_IO_CFG	4090	4090	1	1	4090	nc	1	nc	4090	4090	1	1
ERR_EN_SPSN	SPSN	4090	4090	1	1	4090	nc	1	nc	4090	nc	1	1
ERR_EN_PV	PRESS	4090	4090	1	1	4090	nc	1	nc	4090	nc	1	1
ERR_EN_PP	PRESS_PAR	4090	4090	1	1	4090	nc	1	nc	4090	nc	1	1
ERR_EN_BW	PRESS_BROKEN_W	4090	4090	1	1	4090	nc	1	nc	4090	nc	1	1
ERR_EN_TMED	T_MED	nc	nc	nc	nc	nc	nc	nc	nc	nc	4090	nc	nc
ERR_EN_TCHIP	T_CHIP	ERR_TCHIP	ERR_TCHIP	1	1	ERR_TCHIP	nc	1	nc	ERR_TCHIP	ERR_TCHIP	1	1
ERR_EN_VSUPH	VSUP_HIGH	ERR_VSUP	ERR_VSUP	1	1	ERR_VSUP	nc	1	nc	ERR_VSUP	ERR_VSUP	1	1
ERR_EN_VSUPL	VSUP_LOW	ERR_VSUP	ERR_VSUP	1	1	ERR_VSUP	nc	1	nc	ERR_VSUP	ERR_VSUP	1	1
DIAG_P1	P @ FC1 =	1	nc	1	nc	1	nc	1	nc	1	nc	1	nc
DIAG_P1	P @ FC1 =	4088	nc	1	nc	4088	nc	1	nc	4088	nc	1	nc
DIAG_P2	P @ FC1 =	< Y1	nc	nc	nc	< Y1	nc	nc	nc	< Y1	nc	nc	nc
DIAG_P2	P @ FC1 =	> Y2	nc	nc	nc	> Y2	nc	nc	nc	> Y2	nc	nc	nc
DIAG_T1	T @ FC2 =									nc	1	nc	nc
DIAG_T1	T @ FC2 =									nc	4088	nc	nc
DIAG_T2	T @ FC2 =									nc	<=186	nc	nc
DIAG_T2	T @ FC2 =									nc	>=2266	nc	nc

Table 25: Diagnostics in fast channel configuration 0 - 3

MLX90821

Relative Pressure Sensor IC



ERROR_ENABLE parameter	ERROR	FC_CFG = 4		FC_CFG = 5		FC_CFG = 6				FC1
		FC1	St[0]	FC1	St[0]	FC1	FC2	St[0]	St[1]	
N.A.	no error	P (3x 4b)	0	P (4x 3b)	0	[fc0_ptr]	[fc1_ptr]	0	0	P
-	not calibrated	4095	1	4095	1	nc	nc	nc	nc	4095
DIAG_INT	initialization error	4090	1	4090	1	nc	nc	nc	nc	4090
ERR_EN_TINT	T_INT	nc	nc	nc	nc	nc	nc	nc	nc	nc
ERR_EN_IO	RAM_IO_CFG	4090	1	4090	1	nc	nc	nc	nc	4090
ERR_EN_SPSN	SPSN	4090	1	4090	1	nc	nc	nc	nc	4090
ERR_EN_PV	PRESS	4090	1	4090	1	nc	nc	nc	nc	4090
ERR_EN_PP	PRESS_PAR	4090	1	4090	1	nc	nc	nc	nc	4090
ERR_EN_BW	PRESS_BROKEN_W	4090	1	4090	1	nc	nc	nc	nc	4090
ERR_EN_TMED	T_MED	nc	nc	nc	nc	nc	nc	nc	nc	nc
ERR_EN_TCHIP	T_CHIP	ERR_TCHIP	1	ERR_TCHIP	1	nc	nc	nc	nc	ERR_TCHIP
ERR_EN_VSUPH	VSUP_HIGH	ERR_VSUP	1	ERR_VSUP	1	nc	nc	nc	nc	ERR_VSUP
ERR_EN_VSUPL	VSUP_LOW	ERR_VSUP	1	ERR_VSUP	1	nc	nc	nc	nc	ERR_VSUP
DIAG_P1	P @ FC1 =	1	1	1	1	nc	nc	1	nc	1
DIAG_P1	P @ FC1 =	4088	1	4088	1	nc	nc	1	nc	4088
DIAG_P2	P @ FC1 =	< Y1	nc	< Y1	nc	nc	nc	nc	nc	< Y1
DIAG_P2	P @ FC1 =	>Y2	nc	>Y2	nc	nc	nc	nc	nc	>Y2
DIAG_T1	T @ FC2 =					nc	nc	nc	nc	
DIAG_T1	T @ FC2 =					nc	nc	nc	nc	
DIAG_T2	T @ FC2 =					nc	nc	nc	nc	
DIAG_T2	T @ FC2 =					nc	nc	nc	nc	

Table 26: Diagnostics in fast channel configuration 4 - 7

MLX90821

Relative Pressure Sensor IC



ERROR_ENABLE parameter	ERROR	Slow channel diagnostic
N.A.	no error	000h
-	not calibrated	nc = no change
DIAG_INT	initialization error	003h (only once when reinit passes after reset) (Remark: in contrary to the other errors, DIAG_INT is used here to enable/disable the complete check and customized slow channel error reporting)
ERR_EN_TINT	T_INT	A05h if DIAG_INT=1, else set bit 11 & 10
ERR_EN_IO	RAM_IO_CFG	A05h if DIAG_INT=1, else set bit 11 & 9
ERR_EN_SPSN	SPSN	A05h if DIAG_INT=1, else set bit 11 & 8
ERR_EN_PV	PRESS	A05h if DIAG_INT=1, else set bit 11 & 7
ERR_EN_PP	PRESS_PAR	A05h if DIAG_INT=1, else set bit 11 & 6
ERR_EN_BW	PRESS_BROKEN_W	A05h if DIAG_INT=1, else set bit 11 & 5
ERR_EN_TMED	T_MED	A05h if DIAG_INT=1, else set bit 11 & 4
ERR_EN_TCHIP	T_CHIP	A05h if DIAG_INT=1, else set bit 11 & 0
ERR_EN_VSUPH	VSUP_HIGH	021h / 901h if DIAG_VSUP = 0 / 1, but set bit 11 & 2 if also other errors are reported in the fast channel and if DIAG_INT=0 (if DIAG_INT=1 and other errors, then A05h)
ERR_EN_VSUPL	VSUP_LOW	020h / 900h if DIAG_VSUP = 0 / 1, but set bit 11 & 1 if also other errors are reported in the fast channel and if DIAG_INT=0 (if DIAG_INT=1 and other errors, then A05h)
DIAG_P1	P @ FC1 =	002h if DIAG_PCL = 0 / 812h if DIAG_PCL = 1
DIAG_P1	P @ FC1 =	001h if DIAG_PCL = 0 / 811h if DIAG_PCL = 1
DIAG_P2	P @ FC1 =	002h
DIAG_P2	P @ FC1 =	001h
DIAG_T1	T @ FC2 =	005h
DIAG_T1	T @ FC2 =	004h
DIAG_T2	T @ FC2 =	805h (Remark: value 186 matches with -50 degC)
DIAG_T2	T @ FC2 =	804h (Remark: value 2266 matches with +210 degC)

Table 27: Diagnostics in slow channel

21. SENT Timings

Parameter	Symbol	Comment	Min	Typ	Max	Unit
SENT frame period	tframe	Shortest message (without pause pulse) and longest message (pause pulse enabled). Example in μs calculated using a $3\mu\text{s}$ tick time.	154 462		282 846 ⁽⁸⁾	ticks μs
Start-up time (to first falling edge)	tsu1	Based on default settings.	0.7	1	1.1	ms
Start-up time (up to first data received)	tsu2	First SENT frame contains valid pressure data. Calculation based on $3\mu\text{s}$ tick time.			1.946 ⁽⁸⁾	ms

Table 28: Start-up timings

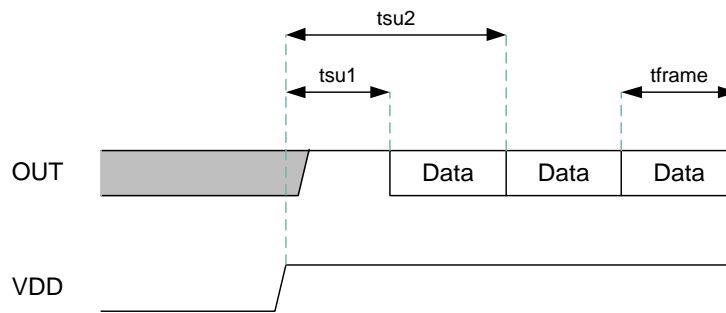

Figure 12: Start-up timings

⁸ Using nominal tick time, excluding tick time variations.

22. Application Information

MLX90821 Application Schematic Analog

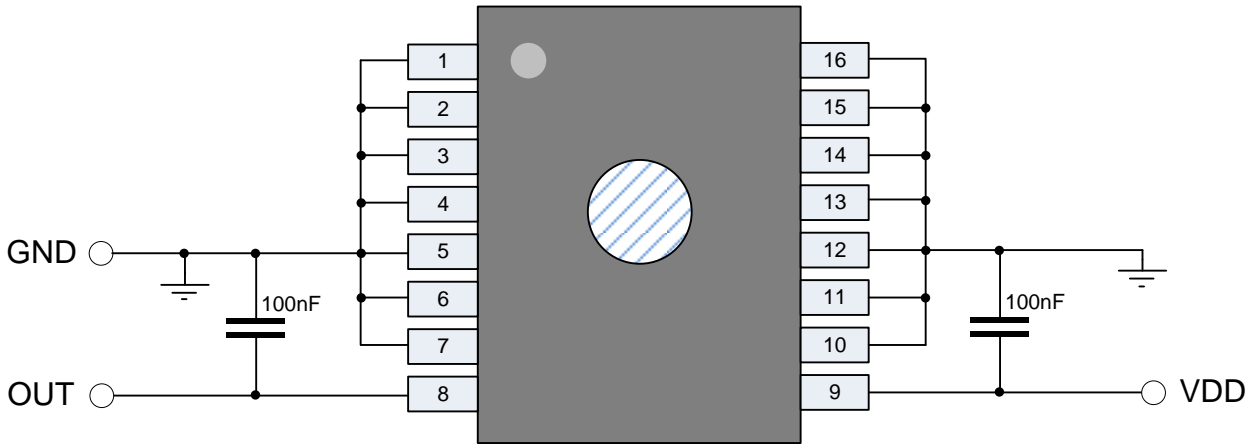

Figure 13: Basic application schematic analog output

MLX90821 Application Schematic SENT

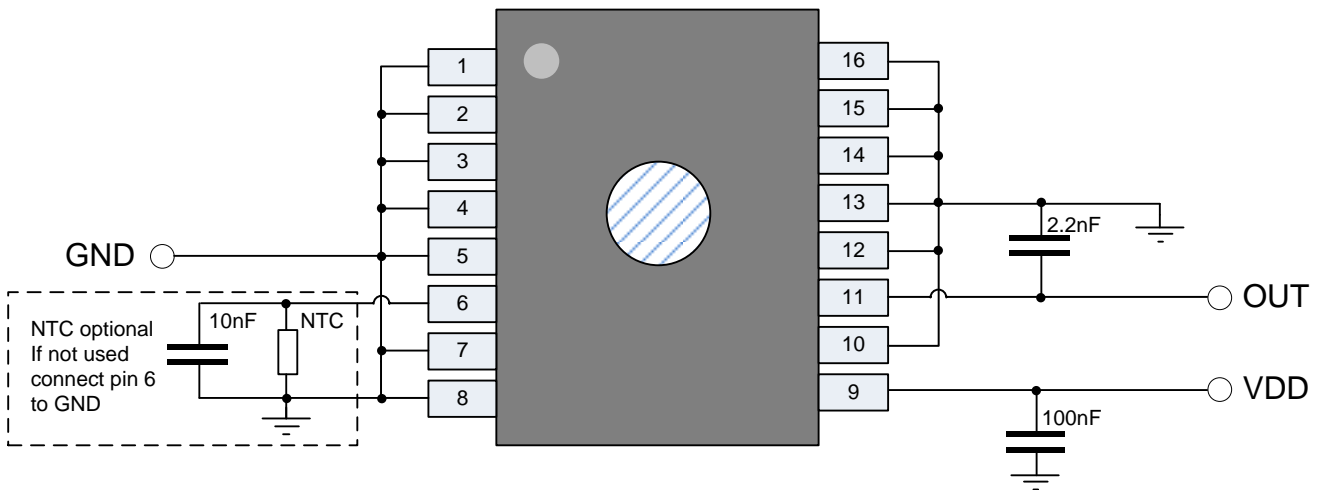

Figure 14: Basic application schematic SENT output

These recommendations for external components are only providing a basic protection. Depending on the module design and the EMC specification requirements different configurations can be needed.

The pressure sensor side facing the PCB shall be exposed only to clean dry air, it should be protected against excessive moisture or any source of corrosion in the application.

23. Standard information regarding manufacturability of Melexis products with different soldering processes

Our products are classified and qualified regarding soldering technology, solderability and moisture sensitivity level according to following test methods:

Reflow Soldering SMD's (Surface Mount Device)s

- IPC/JEDEC J-STD-020
Moisture/Reflow Sensitivity Classification for Nonhermetic Solid State Surface Mount Devices (classification reflow profiles according to table 5-2)
- EIA/JEDEC JESD22-A113
Preconditioning of Nonhermetic Surface Mount Devices Prior to Reliability Testing (reflow profiles according to table 2)

Wave Soldering SMD's (Surface Mount Device)s and THD's (Through Hole Device)s

- EN60749-20
Resistance of plastic- encapsulated SMD's to combined effect of moisture and soldering heat
- EIA/JEDEC JESD22-B106 and EN60749-15
Resistance to soldering temperature for through-hole mounted devices

Iron Soldering THD's (Through Hole Device)s

- EN60749-15
Resistance to soldering temperature for through-hole mounted devices

Solderability SMD's (Surface Mount Device)s and THD's (Through Hole Device)s

- EIA/JEDEC JESD22-B102 and EN60749-21
Solderability

For all soldering technologies deviating from above mentioned standard conditions (regarding peak temperature, temperature gradient, temperature profile etc) additional classification and qualification tests have to be agreed upon with Melexis.

The application of Wave Soldering for SMD's is allowed only after consulting Melexis regarding assurance of adhesive strength between device and board.

Melexis is contributing to global environmental conservation by promoting **lead free** solutions. For more information on qualifications of **RoHS** compliant products (RoHS = European directive on the Restriction Of the use of certain Hazardous Substances) please visit the quality page on our website: <http://www.melexis.com/quality.aspx>

24. ESD Precautions

Electronic semiconductor products are sensitive to Electro Static Discharge (ESD). Always observe Electro Static Discharge control procedures whenever handling semiconductor products.

25. Package Information

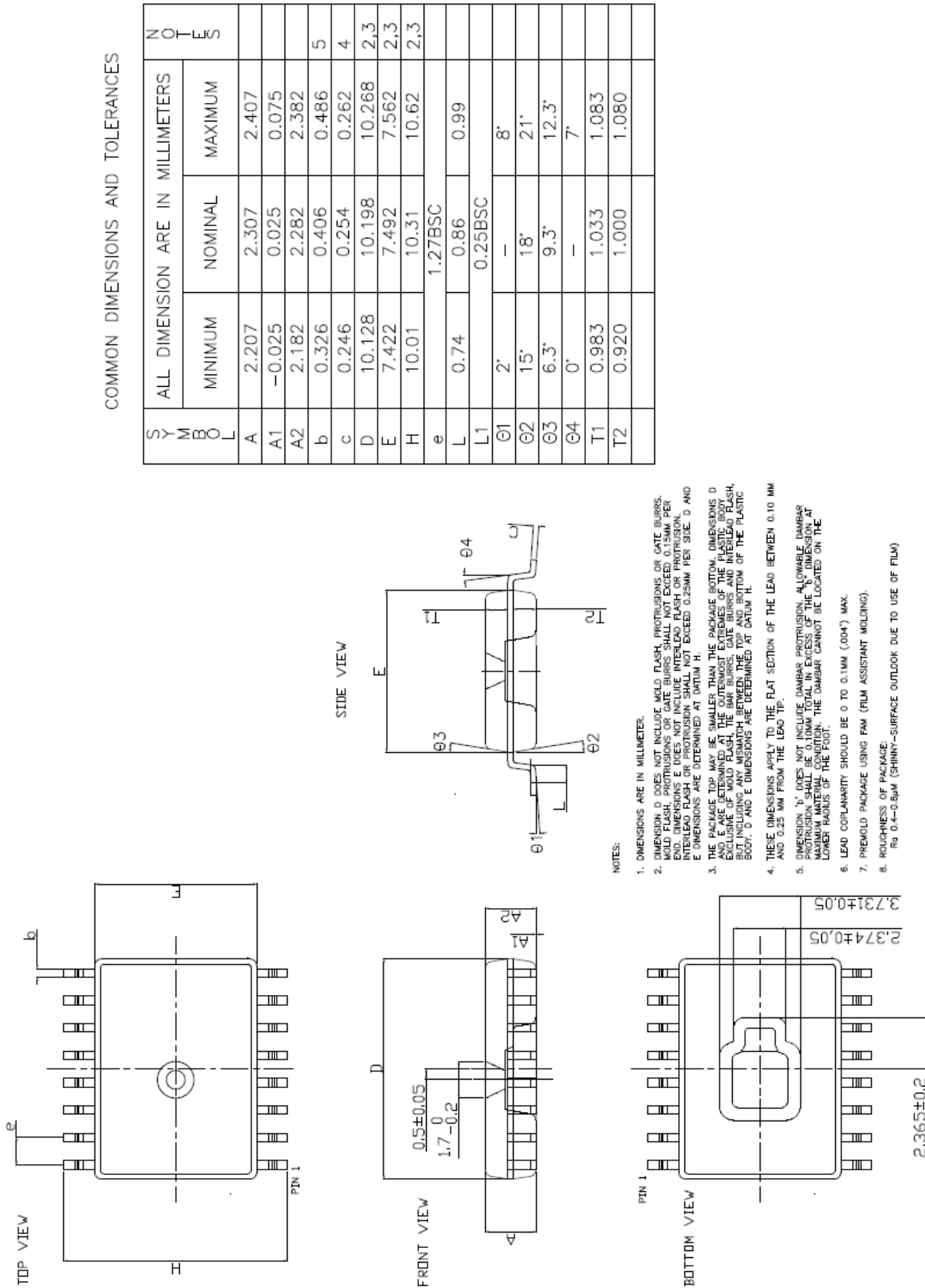

Figure 15: MLX90821 package drawing

26. Contact

For the latest version of this document, go to our website at www.melexis.com.

For additional information, please contact our Direct Sales team and get help for your specific needs:

Europe, Africa	Telephone: +32 13 67 04 95
	Email : sales_europe@melexis.com
Americas	Telephone: +1 603 223 2362
	Email : sales_usa@melexis.com
Asia	Email : sales_asia@melexis.com

27. Disclaimer

The content of this document is believed to be correct and accurate. However, the content of this document is furnished "as is" for informational use only and no representation, nor warranty is provided by Melexis about its accuracy, nor about the results of its implementation. Melexis assumes no responsibility or liability for any errors or inaccuracies that may appear in this document. Customer will follow the practices contained in this document under its sole responsibility. This documentation is in fact provided without warranty, term, or condition of any kind, either implied or expressed, including but not limited to warranties of merchantability, satisfactory quality, non-infringement, and fitness for purpose. Melexis, its employees and agents and its affiliates' and their employees and agents will not be responsible for any loss, however arising, from the use of, or reliance on this document. Notwithstanding the foregoing, contractual obligations expressly undertaken in writing by Melexis prevail over this disclaimer.

This document is subject to change without notice, and should not be construed as a commitment by Melexis. Therefore, before placing orders or prior to designing the product into a system, users or any third party should obtain the latest version of the relevant information.

Users or any third party must determine the suitability of the product described in this document for its application, including the level of reliability required and determine whether it is fit for a particular purpose.

This document as well as the product here described may be subject to export control regulations. Be aware that export might require a prior authorization from competent authorities. The product is not designed, authorized or warranted to be suitable in applications requiring extended temperature range and/or unusual environmental requirements. High reliability applications, such as medical life-support or life-sustaining equipment or avionics application are specifically excluded by Melexis. The product may not be used for the following applications subject to export control regulations: the development, production, processing, operation, maintenance, storage, recognition or proliferation of:

- 1. chemical, biological or nuclear weapons, or for the development, production, maintenance or storage of missiles for such weapons;*
- 2. civil firearms, including spare parts or ammunition for such arms;*
- 3. defense related products, or other material for military use or for law enforcement;*
- 4. any applications that, alone or in combination with other goods, substances or organisms could cause serious harm to persons or goods and that can be used as a means of violence in an armed conflict or any similar violent situation.*

No license nor any other right or interest is granted to any of Melexis' or third party's intellectual property rights.

If this document is marked "restricted" or with similar words, or if in any case the content of this document is to be reasonably understood as being confidential, the recipient of this document shall not communicate, nor disclose to any third party, any part of the document without Melexis' express written consent. The recipient shall take all necessary measures to apply and preserve the confidential character of the document. In particular, the recipient shall (i) hold document in confidence with at least the same degree of care by which it maintains the confidentiality of its own proprietary and confidential information, but no less than reasonable care; (ii) restrict the disclosure of the document solely to its employees for the purpose for which this document was received, on a strictly need to know basis and providing that such persons to whom the document is disclosed are bound by confidentiality terms substantially similar to those in this disclaimer; (iii) use the document only in connection with the purpose for which this document was received, and reproduce document only to the extent necessary for such purposes; (iv) not use the document for commercial purposes or to the detriment of Melexis or its customers. The confidentiality obligations set forth in this disclaimer will have indefinite duration and in any case they will be effective for no less than 10 years from the receipt of this document.

This disclaimer will be governed by and construed in accordance with Belgian law and any disputes relating to this disclaimer will be subject to the exclusive jurisdiction of the courts of Brussels, Belgium.

The invalidity or ineffectiveness of any of the provisions of this disclaimer does not affect the validity or effectiveness of the other provisions. The previous versions of this document are repealed.

Melexis © - No part of this document may be reproduced without the prior written consent of Melexis. (2021)

IATF 16949 and ISO 14001 Certified

X-ON Electronics

Largest Supplier of Electrical and Electronic Components

Click to view similar products for [Board Mount Pressure Sensors](#) category:

Click to view products by [Melexis](#) manufacturer:

Other Similar products are found below :

[6407-249V-17343P](#) [6407-250V-09273P](#) [80527-25.0H2-05](#) [80541-B00000150-01](#) [80541-B00000200-05](#) [80554-00700100-05](#) [80568-00300050-01](#) [93.631.4253.0](#) [93.731.4353.0](#) [93.932.4553.0](#) [136PC150G2](#) [136PC15A1](#) [142PC95AW71](#) [142PC05DW70](#) [15PSI-G-4V](#) [1805-01A-L0N-B](#) [26PCBKT](#) [26PCCFA6D26](#) [26PCCFS2G](#) [26PCCVA6D](#) [93.632.7353.0](#) [93.731.3653.0](#) [93.931.4853.0](#) [93.932.4853.0](#) [SCDA120-XSC05DC](#) [185PC30DH](#) [20INCH-G-MV-MINI](#) [26PCAFJ3G](#) [26PCCEP5G24](#) [26PCDFA3G](#) [26PCJEU5G19](#) [ASCX15AN-90](#) [TSCSAAN001PDUCV](#) [DCAL401DN](#) [DCAL401GN](#) [XZ202798SSC](#) [XZ203676HSC](#) [6407-249V-09343P](#) [6407-250V-17343P](#) [SP370-25-116-0](#) [81794-B00001200-01](#) [HSCDLNN100PGAA5](#) [82681-B00000100-01](#) [81618-B00000040-05](#) [SSCDJNN015PAAA5](#) [TSCDLNN100MDUCV](#) [TSCSAAN100PDUCV](#) [NBPDANN015PGUNV](#) [NBPLLNS150PGUNV](#) [142PC100D](#)