

# MLX92251LSE-AxA

## Dual Hall Effect Latch with Speed & Direction Detection

### Features and Benefits

- Operating Voltage from 2.7V to 24V
- Two Integrated Hall plates for Direction Detection
- Latching Magnetic Characteristics
- Speed & Direction Open-Drain Outputs
- Direction Output updated prior Speed Output
- Excellent Temperature Stability
- Reverse Supply Voltage Protection
- Output Current Limitation and Auto-Shutoff
- Under-Voltage Lockout Protection

### Applications

- Windows lifter with Anti-Pinch feature
- Rotation speed & direction detection
- Linear speed & direction detection
- Angular position detection
- Power closures with Anti-Pinch features

### Ordering information

Part No.	Temperature Code	Sensitivity	Package Code	Packing Form
MLX92251LSE-AAA-000-RE	L (-40°C to 150°C)	± 7.5 mT	SE (TSOT-5L)	RE (Tape & Reel)
MLX92251LSE-ABA-000-RE	L (-40°C to 150°C)	± 2.5 mT	SE (TSOT-5L)	RE (Tape & Reel)

#### Legend:

Temperature Code: L for Temperature Range -40°C to 150°C  
Package Code: SE for TSOT,  
Packing Form: RE for Reel  
Ordering example: MLX92251LSE-AAA-000-RE

## 1. Functional Diagram

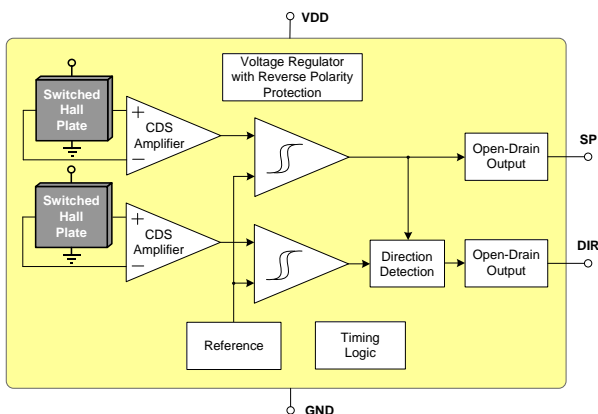

## 2. General Description

The Melexis MLX92251 is a second generation Hall-effect dual latch designed in mixed signal CMOS technology. The device integrates a voltage regulator, two Hall sensors with advanced offset cancellation system and two open-drain output drivers, all in a single package.

Two Hall plates are integrated on the same piece of silicon, thus using the high precision of the wafer fabrication process to ensure a fixed

spacing of 1.45mm between the sensing elements. The first Hall plate signal is used to provide the speed signal output. The combination of both the first and second Hall plate signals is then internally processed to directly deliver a direction signal output.

The MLX92251 shares the MLX922xx-based platform, synonym of high performance in terms of electrical specification, magnetic specification and protection level.

With latching magnetic characteristics, the speed (SP) output is turned low or high respectively with a sufficiently strong South or North pole facing the package top side. When removing the magnetic field, the device keeps its previous state.

The direction (DIR) output is latched in Low or High state depending on the movement direction of the applied magnetic field, as a result of certain magnetic pulse sequence on both Hall sensors.

The MLX92251 is delivered in a Green compliant 5-pin Thin Small Outline Transistor (TSOT) for surface-mount process.

## Contents

1. Functional Diagram .....	1
2. General Description .....	1
3. Glossary of Terms.....	3
4. Absolute Maximum Ratings.....	3
5. General Electrical Specifications.....	4
6. Magnetic Specifications .....	5
6.1. MLX92251LSE-AAA-000 .....	5
6.2. MLX92251LSE-ABA-000.....	5
7. Output Behaviour versus Magnetic Pole .....	6
8. Application Information .....	7
8.1. Default Application Schematic.....	7
8.2. Recommended Application Schematic for ISO7637-2 (pulses 5a and 5b).....	7
8.3. Speed (SP) Output Behavior vs. BOP/BRP .....	7
8.4. Output Jitter, Speed Signal Delay and Direction Detection .....	8
8.5. UV lockout and POR behaviour.....	8
9. Performance Graphs .....	9
9.1. Magnetic parameters vs. $T_A$ .....	9
9.2. Magnetic parameters vs. $V_{DD}$ .....	9
9.3. $V_{DSON}$ vs. $T_A$ .....	9
9.4. $V_{DSON}$ vs. $V_{DD}$ .....	9
9.5. $I_{DD}$ vs. $T_A$ .....	9
9.6. $I_{DD}$ vs. $V_{DD}$ .....	9
9.7. $I_{LEAK}$ vs. $T_A$ .....	10
9.8. $I_{LEAK}$ vs. $V_{DD}$ .....	10
9.9. Power Derating vs. $T_A$ .....	10
10. Standard information regarding manufacturability of Melexis products with different soldering processes .....	11
11. ESD Precautions .....	11
12. SE Package Information.....	12
12.1. Pin Definitions and Descriptions.....	12
13. Contact .....	13
14. Disclaimer .....	13

### 3. Glossary of Terms

MilliTesla (mT), Gauss	Units of magnetic flux density: 1mT = 10 Gauss
RoHS	Restriction of Hazardous Substances
TSOT	Thin Small Outline Transistor (TSOT package) – also referred with the Melexis package code “SE”
ESD	Electro-Static Discharge

### 4. Absolute Maximum Ratings

Parameter	Symbol	Value	Units
Supply Voltage	$V_{DD}$	+27	V
Supply Current	$I_{DD}$	+20	mA
Reverse Supply Voltage	$V_{DDREV}$	-27	V
Reverse Supply Current	$I_{DDREV}$	-20	mA
Output Voltage	$V_{OUT}$	+27	V
Output Current	$I_{OUT}$	+20	mA
Reverse Output Voltage	$V_{OUTREV}$	-0.5	V
Reverse Output Current	$I_{OUTREV}$	-50	mA
Operating Temperature Range	$T_A$	-40 to +150	°C
Storage Temperature Range	$T_S$	-55 to +165	°C
Maximum Junction Temperature	$T_J$	+165	°C
ESD Sensitivity – HBM <sup>(1)</sup>	-	2500	V
ESD Sensitivity – CDM <sup>(2)</sup>	-	1000	V
Magnetic Flux Density	B	Unlimited	mT

Table 1. Absolute maximum ratings

Exceeding the absolute maximum ratings may cause permanent damage.

Exposure to absolute-maximum-rated conditions for extended periods may affect device reliability.

<sup>1</sup> Human Body Model according AEC-Q100-002 standard.

<sup>2</sup> Charged Device Model according AEC-Q100-011 standard.

## 5. General Electrical Specifications

DC Operating Parameters  $T_A = -40^{\circ}\text{C}$  to  $150^{\circ}\text{C}$ ,  $V_{DD} = 2.7\text{V}$  to  $24\text{V}$  (unless otherwise specified)

Parameter	Symbol	Test Conditions	Min	Typ <sup>(1)</sup>	Max	Units
Supply Voltage	$V_{DD}$	Operating	2.7	-	24	V
Supply Current	$I_{DD}$	$V_{DD} = 12\text{V}$	3	4.5	7	mA
Reverse Supply Current	$I_{DDREV}$	$V_{DD} = -18\text{V}$			1	mA
Output Leakage Current	$I_{OFF}$	$V_{OUT} = 12\text{V}$ , $V_{DD} = 12\text{V}$ , $B < B_{RP}$		0.1	10	$\mu\text{A}$
Output Saturation Voltage	$V_{OUTS}$	$B > B_{OP}$ , $I_{OUT} = 10\text{mA}$		0.2	0.5	V
Output Rise/Fall Time <sup>(2,3)</sup>	$t_R / t_F$	$V_{DD} = 12\text{V}$ , $V_{PU}^{(4)} = 5\text{V}$ , $R_{PU} = 1\text{k}\Omega$ , $C_L = 50\text{pF}$	0.1	0.3	1	$\mu\text{s}$
Output Current Limit	$I_{CL}$	$B > B_{OP}$ , $V_{OUT} = 12\text{V}$	14	25	44	mA
Output ON Time under Current Limit conditions <sup>(5)</sup>	$t_{CLON}$	$B > B_{OP}$ , $V_{PU} = 12\text{V}$ , $R_{PU} = 100\Omega$	150	230		$\mu\text{s}$
Output OFF Time under Current Limit conditions <sup>(5)</sup>	$t_{CLOFF}$	$B > B_{OP}$ , $V_{PU} = 12\text{V}$ , $R_{PU} = 100\Omega$		3.5		ms
Chopping Frequency	$f_{CHOP}$			400		kHz
Speed Signal Delay <sup>(2,6)</sup>	$t_{SPD}$		0.4	0.85	1.6	$\mu\text{s}$
Output Refresh Period	$t_{PER}$		3.2	5	8.4	$\mu\text{s}$
Output Jitter (p-p value) <sup>(2)</sup>	$t_{JITTER}$	Over 1000 successive output switching events @1kHz square wave, $B_{PEAK} = 50\text{mT}$ , $t_{RISE} = t_{FALL} \leq 100\mu\text{s}$		$\pm 2.6$		$\mu\text{s}$
Maximum Switching Frequency <sup>(2,7)</sup>	$f_{SW}$	$\geq 30\text{mT}$ square wave magnetic field	40	66		kHz
Power-On Time <sup>(8)</sup>	$t_{PON}$	$V_{DD} = 5\text{V}$ , $dV_{DD}/dt > 2\text{V}/\mu\text{s}$		16	35	$\mu\text{s}$
Under-voltage Lockout Threshold	$V_{UVL}$		2.2	2.4	2.7	V
Under-voltage Lockout Reaction time <sup>(2)</sup>	$t_{UVL}$			1		$\mu\text{s}$
SE Package Thermal Resistance	$R_{TH}$	Single layer (1S) JEDEC board		300		$^{\circ}\text{C}/\text{W}$

Table 2: electrical specifications

1 Typical values are defined at  $T_A = +25^{\circ}\text{C}$  and  $V_{DD} = 12\text{V}$

2 Based on device characterization results, not subject to production test

3 Measured between  $0.1 \cdot V_{PU}$  and  $0.9 \cdot V_{PU}$

4  $R_{PU}$  and  $V_{PU}$  are respectively the external pull-up resistor and pull-up power supply

5 If the Output is in Current Limitation longer than  $t_{CLON}$  the Output is switched off in high-impedance state. The Output returns back in active state at next reaching of  $B_{OP}$  or after  $t_{CLOFF}$  time interval

6 Controlled delay between direction (DIR) signal update and speed (SP) signal update

7 Maximum switching frequency corresponds to the maximum frequency of the applied magnetic field which is detected without loss of pulses

8 The Power-On Time represents the time from reaching  $V_{DD} = 2.7\text{V}$  to the first refresh of the SP output

## 6. Magnetic Specifications

### 6.1. MLX92251LSE-AAA-000

DC Operating Parameters  $V_{DD} = 2.7V$  to  $24V$  and  $T_A = -40^{\circ}C$  to  $150^{\circ}C$  (unless otherwise specified)

Parameter	Symbol	Test Conditions	Min	Typ	Max	Units
Operating Point	$B_{OP}$		5	7.5	10	mT
Release Point	$B_{RP}$		-10	-7.5	-5	mT
Magnetic Matching	$B_{MATCH}$	$B_{OP1} - B_{OP2}$ OR $B_{RP1} - B_{RP2}$ , $T_A = 25^{\circ}C$	-2		2	mT
		$B_{OP1} - B_{OP2}$ OR $B_{RP1} - B_{RP2}$	-3		3	mT
Magnetic Offset	$B_{OFF}$	$(B_{OP1} + B_{RP1}) / 2$ , $(B_{OP2} + B_{RP2}) / 2$	-2		2	mT
Temperature Coefficient	TC			0		ppm/ $^{\circ}C$
Hall Plates Spacing	-			1.45		mm

Table 3: Magnetic specifications

### 6.2. MLX92251LSE-ABA-000

DC Operating Parameters  $V_{DD} = 2.7V$  to  $24V$  and  $T_A = -40^{\circ}C$  to  $150^{\circ}C$  (unless otherwise specified)

Parameter	Symbol	Test Conditions	Min	Typ	Max	Units
Operating Point	$B_{OP}$		0.6	2.5	4.5	mT
Release Point	$B_{RP}$		-4.5	-2.5	-0.6	mT
Magnetic Matching	$B_{MATCH}$	$B_{OP1} - B_{OP2}$ OR $B_{RP1} - B_{RP2}$ , $T_A = 25^{\circ}C$	-2		2	mT
		$B_{OP1} - B_{OP2}$ OR $B_{RP1} - B_{RP2}$	-3		3	mT
Magnetic Offset	$B_{OFF}$	$(B_{OP1} + B_{RP1}) / 2$ , $(B_{OP2} + B_{RP2}) / 2$	-2		2	mT
Temperature Coefficient	TC			-1100		ppm/ $^{\circ}C$
Hall Plates Spacing	-			1.45		mm

Table 3: Magnetic specifications

**Note:** Temperature coefficient value is guaranteed by design and verified by characterization and is calculated using the following formula:

$$TC = \frac{B_{T_2} - B_{T_1}}{B_{25^{\circ}C} \times (T_2 - T_1)} * 10^6, ppm/^{\circ}C; T_1 = -40^{\circ}C; T_2 = 150^{\circ}C$$

## 7. Output Behavior versus Magnetic Pole

DC Operating Parameters  $T_A = -40^{\circ}\text{C}$  to  $150^{\circ}\text{C}$ ,  $V_{DD} = 2.7\text{V}$  to  $24\text{V}$  (unless otherwise specified)

Parameter	Test Conditions	SP Output State
South pole	$B > B_{OP}$	Low
North pole	$B < B_{RP}$	High <sup>(1)</sup>

Table 4: Output behavior versus magnetic pole<sup>(2)</sup>

Direction	Step	H1	H2	DIR Output State
<b>CCW</b>	$n_x$	N	S	<b>Low</b>
	$n_{(x+1)}$	N	N	
	$n_{(x+2)}$	S	N	
	$n_{(x+3)}$	S	S	
	$n_{(x+4)} \equiv n_x$	N	S	

Direction	Step	H1	H2	DIR Output State
<b>CW</b>	$n_x$	N	S	<b>High<sup>(3)</sup></b>
	$n_{(x+1)}$	S	S	
	$n_{(x+2)}$	S	N	
	$n_{(x+3)}$	N	N	
	$n_{(x+4)} \equiv n_x$	N	S	

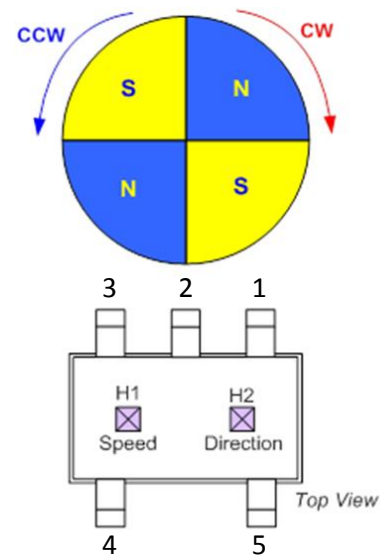

<sup>1</sup> Default SP output state during power-up

<sup>2</sup> Magnetic pole applied perpendicularly to Hall plate "H1", facing the branded/top side of the package

<sup>3</sup> Default magnetic and DIR output state during power-up

## 8. Application Information

### 8.1. Default Application Schematic

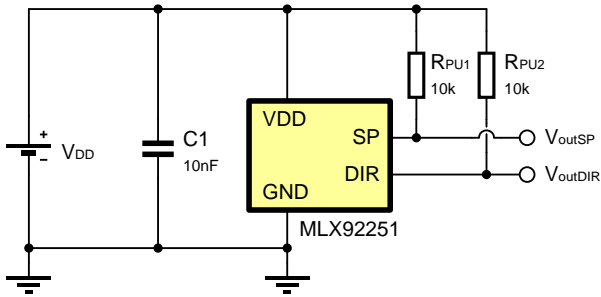

### 8.2. Recommended Application Schematic for ISO7637-2 (pulses 5a and 5b)

Notes:

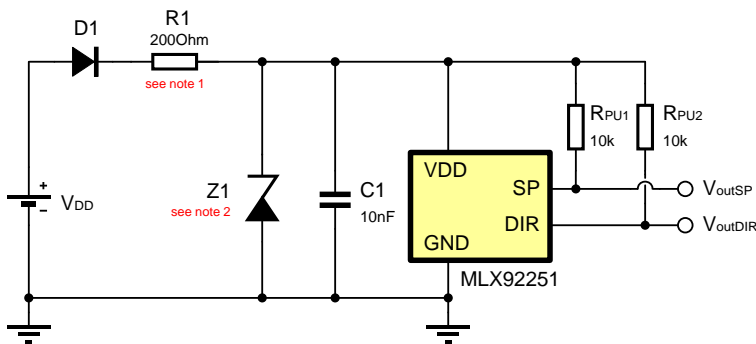

1. Recommended for conducted transients on supply line above 32V with duration above 500ms.
2. Recommended for conducted transients on supply line above 36V.
3. Recommended zener diode Z1 is BZX55C27 or equivalent.

### 8.3. Speed (SP) Output Behavior vs. $B_{OP}/B_{RP}$

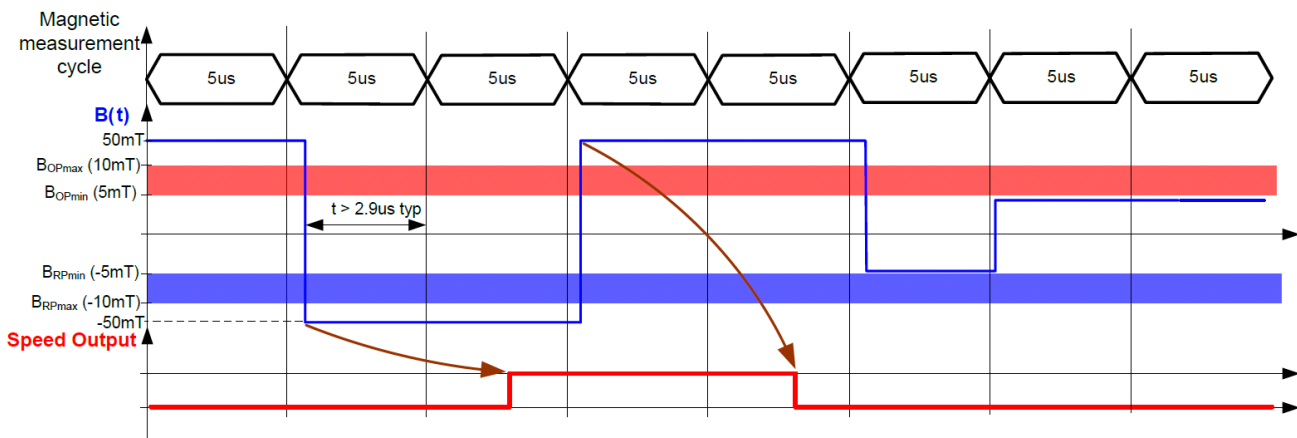

Note: The decision for output update is taken at the end of each magnetic measurement cycle

### 8.4. Output Jitter, Speed Signal Delay and Direction Detection

#### Output Jitter

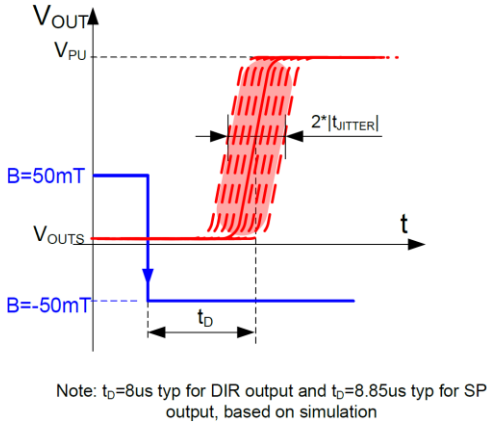

#### Direction Detection

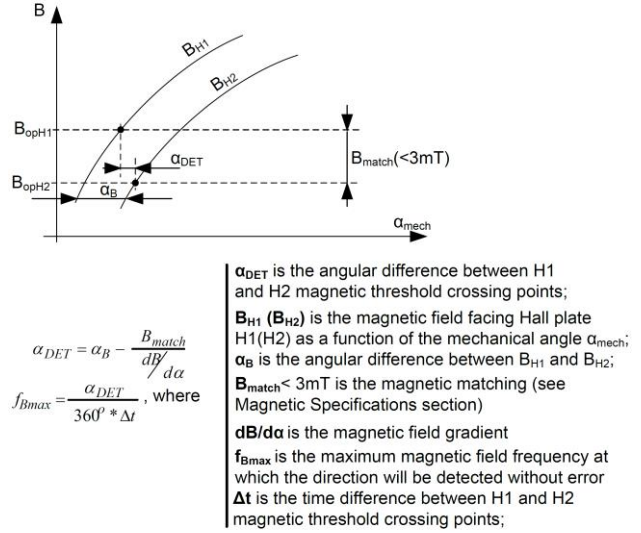

For example, if  $\alpha_B = 5^\circ$  and  $dB/d\alpha > 1mT^\circ$ ;  
 for MLX92251  $\Delta t = 10\mu s$  (definitely  $> 2 * |t_{JITTER}|$ ) could be assumed;  
 The calculated  $f_{Bmax} = 555Hz$ .

#### Speed Signal Delay

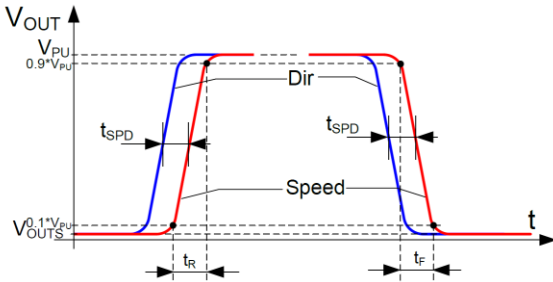

### 8.5. UV lockout and POR behaviour

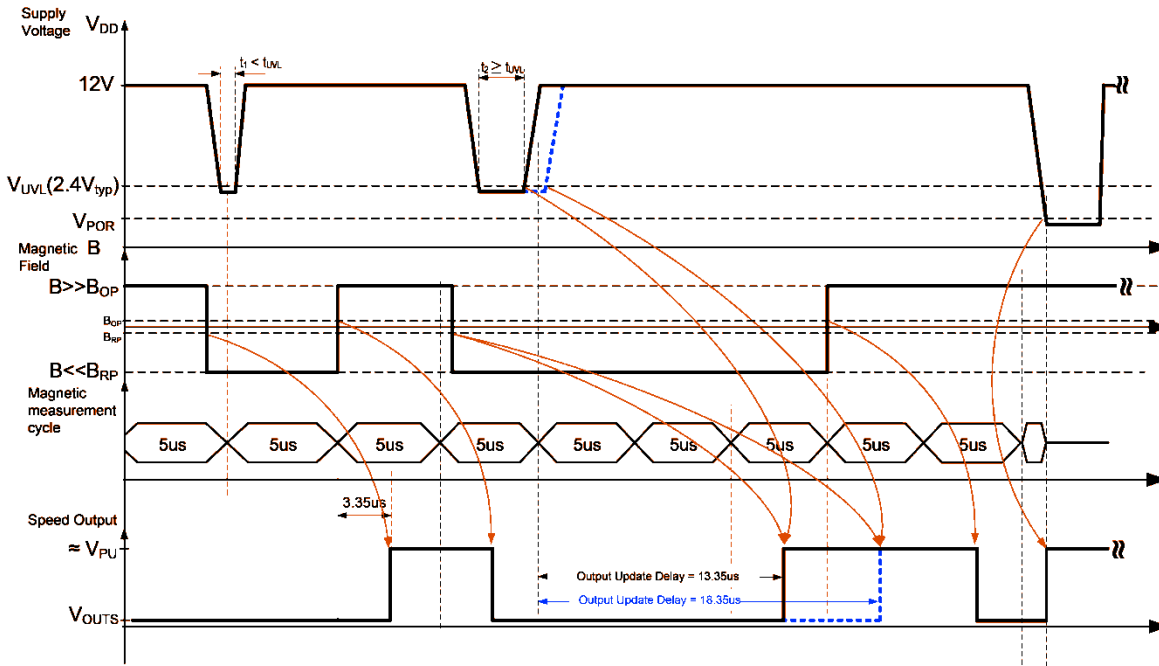

NOTE: Start-up behaviour feature does not occur after under-voltage lockout.  $V_{POR} \leq 2V$  (based on device characterization results).



## 9. Performance Graphs

9.1. Magnetic parameters vs.  $T_A$

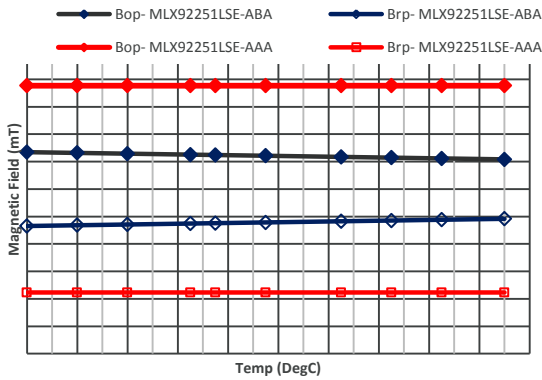

9.2. Magnetic parameters vs.  $V_{DD}$

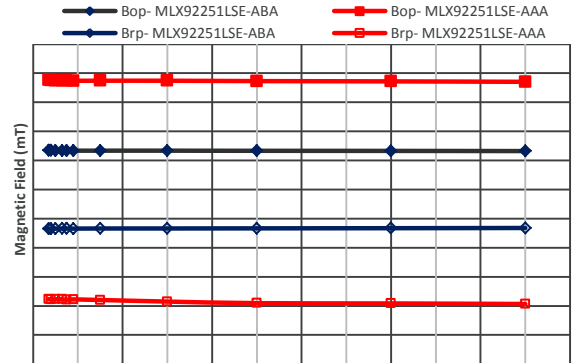

9.3.  $V_{DSON}$  vs.  $T_A$

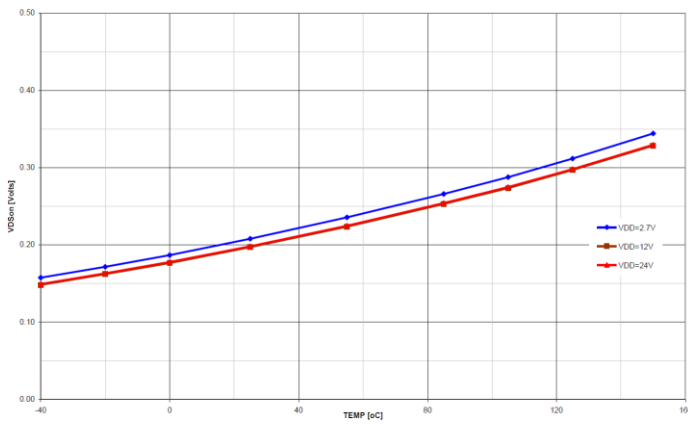

9.4.  $V_{DSON}$  vs.  $V_{DD}$

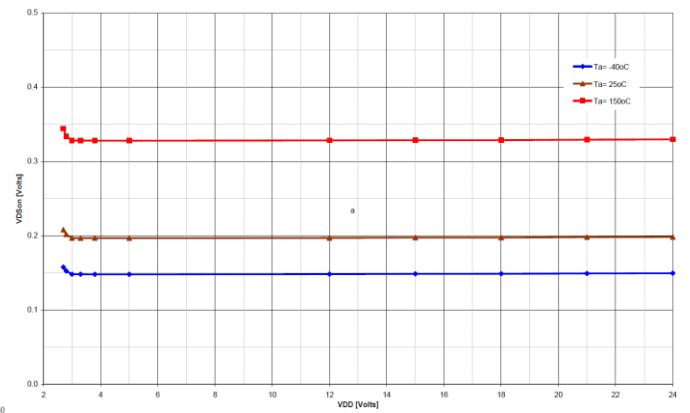

9.5.  $I_{DD}$  vs.  $T_A$

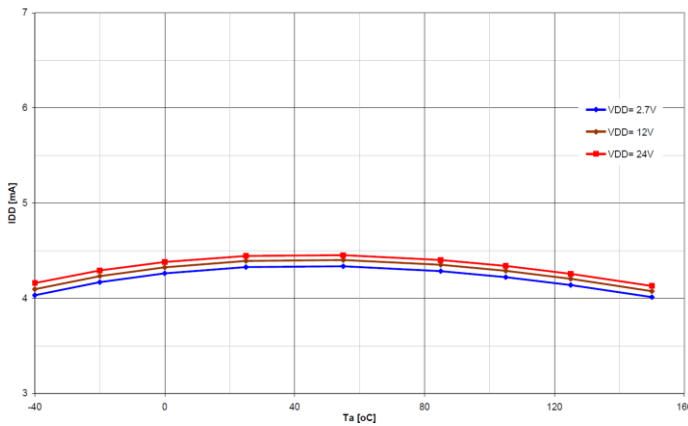

9.6.  $I_{DD}$  vs.  $V_{DD}$

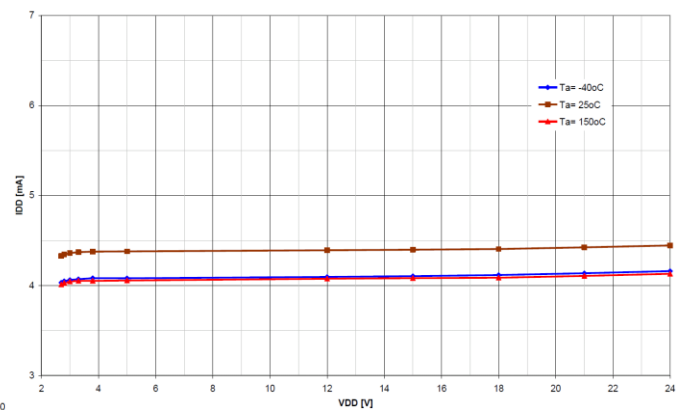

### 9.7. $I_{LEAK}$ vs. $T_A$

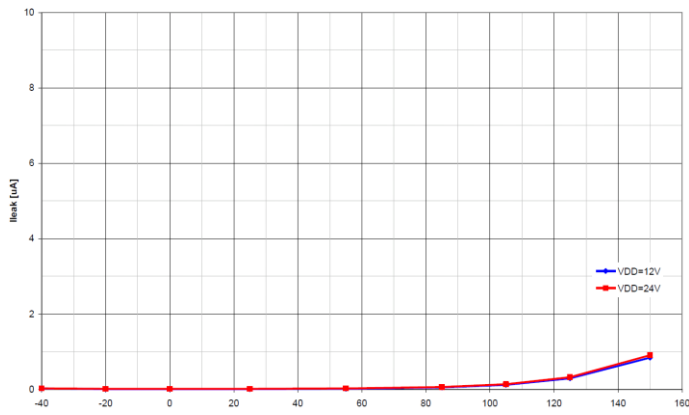

### 9.8. $I_{LEAK}$ vs. $V_{DD}$

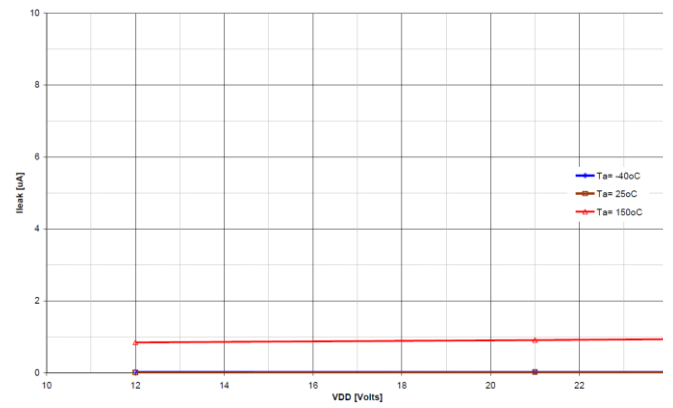

### 9.9. Power Derating vs. $T_A$

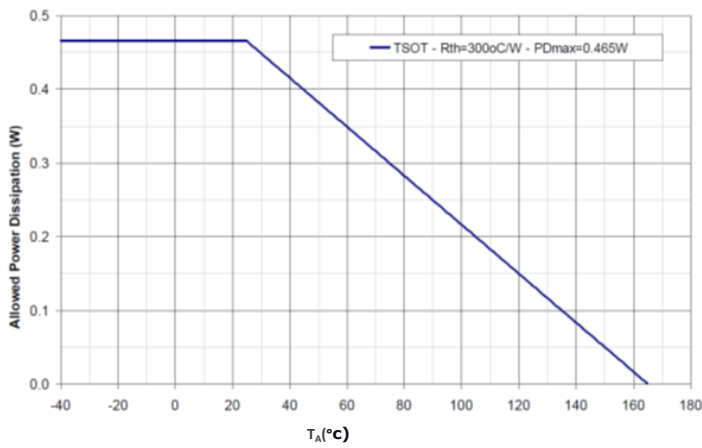

## 10. Standard information regarding manufacturability of Melexis products with different soldering processes

Our products are classified and qualified regarding soldering technology, solderability and moisture sensitivity level according to following test methods:

### Reflow Soldering SMD's (Surface Mount Devices)

- IPC/JEDEC J-STD-020  
Moisture/Reflow Sensitivity Classification for Nonhermetic Solid State Surface Mount Devices (classification reflow profiles according to table 5-2)
- EIA/JEDEC JESD22-A113  
Preconditioning of Nonhermetic Surface Mount Devices Prior to Reliability Testing (reflow profiles according to table 2)

### Wave Soldering SMD's (Surface Mount Devices) and THD's (Through Hole Devices)

- EN60749-20  
Resistance of plastic- encapsulated SMD's to combined effect of moisture and soldering heat
- EIA/JEDEC JESD22-B106 and EN60749-15  
Resistance to soldering temperature for through-hole mounted devices

### Iron Soldering THD's (Through Hole Devices)

- EN60749-15  
Resistance to soldering temperature for through-hole mounted devices

### Solderability SMD's (Surface Mount Devices) and THD's (Through Hole Devices)

- EIA/JEDEC JESD22-B102 and EN60749-21  
Solderability

For all soldering technologies deviating from above mentioned standard conditions (regarding peak temperature, temperature gradient, temperature profile etc) additional classification and qualification tests have to be agreed upon with Melexis.

The application of Wave Soldering for SMD's is allowed only after consulting Melexis regarding assurance of adhesive strength between device and board.

Melexis recommends reviewing on our web site the General Guidelines [soldering recommendation](http://www.melexis.com/Quality_soldering.aspx) ([http://www.melexis.com/Quality\\_soldering.aspx](http://www.melexis.com/Quality_soldering.aspx)) as well as [trim&form recommendations](http://www.melexis.com/Assets/Trim-and-form-recommendations-5565.aspx) (<http://www.melexis.com/Assets/Trim-and-form-recommendations-5565.aspx>).

Melexis is contributing to global environmental conservation by promoting **lead free** solutions. For more information on qualifications of **RoHS** compliant products (RoHS = European directive on the Restriction Of the use of certain Hazardous Substances) please visit the quality page on our website: <http://www.melexis.com/quality.aspx>

## 11. ESD Precautions

Electronic semiconductor products are sensitive to Electro Static Discharge (ESD).

Always observe Electro Static Discharge control procedures whenever handling semiconductor products.

## 12. SE Package Information

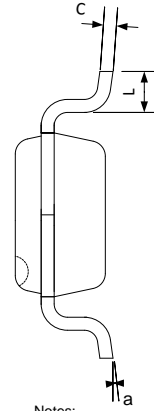
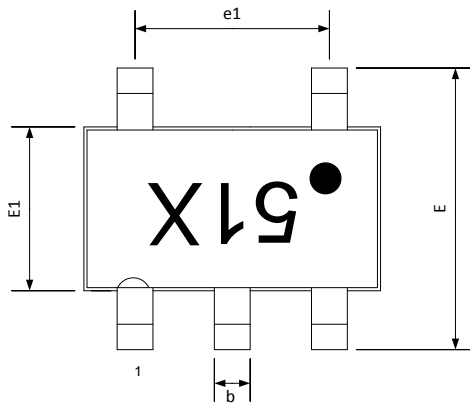

**Notes:**

1. Dimension "D" and "E1" do not include mold flash or protrusions. Mold flash or protrusion shall not exceed 0.15mm on "D" and 0.25mm on "E" per side.
2. Dimension "b" does not include dambar protrusion.
3. This part is compliant with JEDEC specification MO-193. This part is full compliance to EIAJ specification SC-74.

**Marking:**

Top Side:

- 51A – MLX92251LSE-AAA-000
- 51C – MLX92251LSE-ABA-000

Bottom Side: xyww x = last digit of lot number

y = last digit of year

ww = week

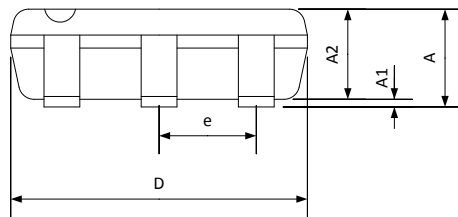

**Hall plate location**

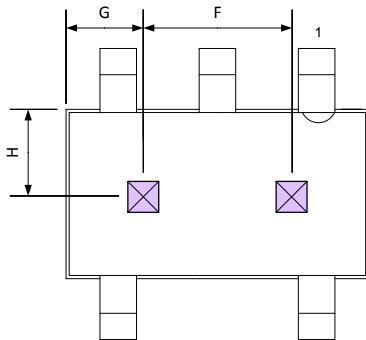

**TOP VIEW**

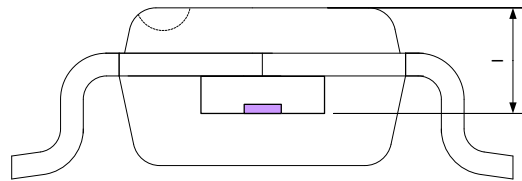

**END VIEW**

This table in mm

	A	A1	A2	D	E	E1	L	b	c	e	e1	F	G	H	I	$\alpha$
min	–	0.025	0.85	2.80	2.60	1.50	0.30	0.30	0.10	0.95	1.90	1.45	0.525	0.6	0.562	0°
max	1.00	0.10	0.90	3.00	3.00	1.70	0.50	0.45	0.20	BSC	BSC	1.45	0.925	1	0.622	8°

### 12.1. Pin Definitions and Descriptions

SE Pin No	Name	Type	Function
1	VDD	Supply	Power Supply
2,3	GND	Ground	Ground pin
4	SP	Output	Speed Open-Drain Output
5	DIR	Output	Direction Open-Drain Output

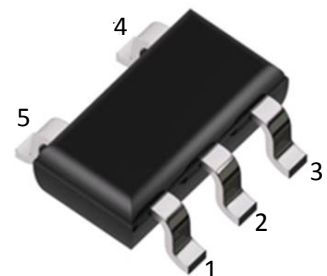

## 13. Contact

For the latest version of this document, go to our website at [www.melexis.com](http://www.melexis.com).

For additional information, please contact our Direct Sales team and get help for your specific needs:

Europe, Africa	Telephone: +32 13 67 04 95
	Email : sales_europe@melexis.com
Americas	Telephone: +1 603 223 2362
	Email : sales_usa@melexis.com
Asia	Email : sales_asia@melexis.com

## 14. Disclaimer

*The information furnished by Melexis herein ("Information") is believed to be correct and accurate. Melexis disclaims (i) any and all liability in connection with or arising out of the furnishing, performance or use of the technical data or use of the product(s) as described herein ("Product") (ii) any and all liability, including without limitation, special, consequential or incidental damages, and (iii) any and all warranties, express, statutory, implied, or by description, including warranties of fitness for particular purpose, non-infringement and merchantability. No obligation or liability shall arise or flow out of Melexis' rendering of technical or other services.*

*The Information is provided "as is" and Melexis reserves the right to change the Information at any time and without notice. Therefore, before placing orders and/or prior to designing the Product into a system, users or any third party should obtain the latest version of the relevant information to verify that the information being relied upon is current. Users or any third party must further determine the suitability of the Product for its application, including the level of reliability required and determine whether it is fit for a particular purpose.*

*The Information is proprietary and/or confidential information of Melexis and the use thereof or anything described by the Information does not grant, explicitly or implicitly, to any party any patent rights, licenses, or any other intellectual property rights.*

*This document as well as the Product(s) may be subject to export control regulations. Please be aware that export might require a prior authorization from competent authorities.*

*The Product(s) are intended for use in normal commercial applications. Unless otherwise agreed upon in writing, the Product(s) are not designed, authorized or warranted to be suitable in applications requiring extended temperature range and/or unusual environmental requirements. High reliability applications, such as medical life-support or life-sustaining equipment are specifically not recommended by Melexis.*

*The Product(s) may not be used for the following applications subject to export control regulations: the development, production, processing, operation, maintenance, storage, recognition or proliferation of 1) chemical, biological or nuclear weapons, or for the development, production, maintenance or storage of missiles for such weapons; 2) civil firearms, including spare parts or ammunition for such arms; 3) defense related products, or other material for military use or for law enforcement; 4) any applications that, alone or in combination with other goods, substances or organisms could cause serious harm to persons or goods and that can be used as a means of violence in an armed conflict or any similar violent situation.*

*The Products sold by Melexis are subject to the terms and conditions as specified in the Terms of Sale, which can be found at <https://www.melexis.com/en/legal/terms-and-conditions>.*

*This document supersedes and replaces all prior information regarding the Product(s) and/or previous versions of this document.*

*Melexis NV © - No part of this document may be reproduced without the prior written consent of Melexis. (2016)*

*ISO/TS 16949 and ISO14001 Certified*

## X-ON Electronics

Largest Supplier of Electrical and Electronic Components

*Click to view similar products for [Board Mount Hall Effect/Magnetic Sensors](#) category:*

*Click to view products by [Melexis](#) manufacturer:*

Other Similar products are found below :

[HGPRDT005A](#) [AH277AZ4-AG1](#) [AV-10379](#) [AV-10448](#) [SS41C](#) [AH1894-Z-7](#) [ATS601LSGTN-LT-WU4-T](#) [TLE4917](#) [50017859-003](#) [TY-13101](#) [TLE4976L](#) [AH49FNTR-G1](#) [SS85CA](#) [AH277AZ4-BG1](#) [TLE49614MXTSA1](#) [AH3377-P-B](#) [AH211Z4-AG1](#) [AH3360-FT4-7](#) [SS460S-100SAMPLE](#) [50065820-03](#) [TLE4941PLUSCB](#) [AH374-P-A](#) [AH1806-P-A](#) [AH374-W-7](#) [SS460P-T2](#) [AH1913-W-7](#) [SS413F](#)  
[TLE5046ICAKLRHALA1](#) [TLE49421CHAMA2](#) [TLE4941PLUSCXAMA1](#) [AH1912-W-EVM](#) [AH1903-FA-EVM](#) [AH3774-W-EVM](#)  
[AH49FNTR-EVM](#) [MMC5633NJL](#) [AH3360-FA-EVM](#) [AH8502-FDC-EVM](#) [AH3366Q-SA-EVM](#) [AH3774-P-EVM](#) [KTH1601SU-ST3](#)  
[MG910](#) [MG910M](#) [MG911](#) [MG610](#) [MW921](#) [MW922](#) [TLE4998S3XALA1](#) [TLE5011FUMA1](#) [TLE5027CE6747HAMA1](#)  
[TLE5109A16E2210XUMA1](#)