

US5681

Unipolar Hall Switch – High Sensitivity

Features and Benefits

- Wide operating voltage range from 3.5V to 24V
- High sensitivity
- CMOS technology
- Chopper-stabilized amplifier stage
- Low current consumption
- Open drain output
- Thin SOT23 3L RoHS Compliant package

Applications

- Automotive, Consumer and Industrial
- Solid-state switch
- Interrupter
- Current detector
- Proximity detection

Ordering information

Product code	Temperature Code	Package Code	Option code	Packing form code
US5681	E	SE	AAA-000	RE
US5681	K	SE	AAA-000	RE

Legend:

Temperature code: E(-40 to 85°C)
K (-40 to 125°C)
Package Code: SE = TSOT-23L
Packing Form: RE = Reel
Ordering Example: US5681ESE-AAA-000-RE

1. Functional Diagram

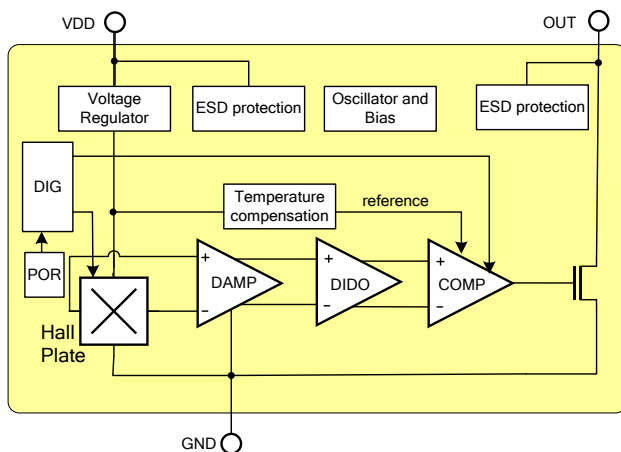

2. General Description

The Melexis US5681 is a unipolar Hall-effect switch designed in mixed signal CMOS technology.

The device integrates a voltage regulator; Hall sensor with advanced Correlated Double Sampling (CDS) offset cancellation system and an open-drain output driver, all in a single package.

Thanks to its wide operating voltage range and temperature range, it is suitable for use in automotive and solid state switch applications.

The device is delivered in a Thin Small Outline Transistor (TSOT) 3-lead RoHS compliant package.

Contents

1. Functional Diagram	1
2. General Description.....	1
3. Glossary of Terms.....	3
4. Absolute Maximum Ratings.....	3
5. Pin Definitions and Descriptions	3
6. General Electrical Specifications.....	4
7. Magnetic Specifications.....	4
8. Output Behaviour versus Magnetic Pole	5
9. Detailed General Description.....	5
10. Unique Features	5
11. Performance Graphs	6
11.1. Magnetic parameters vs. T_A	6
11.2. Magnetic parameters vs. V_{DD}	6
11.3. V_{DSon} vs. T_A	6
11.4. V_{DSon} vs. V_{DD}	6
11.5. I_{DD} vs. T_A	6
11.6. I_{DD} vs. V_{DD}	6
12. Test Conditions.....	7
12.1. Supply Current	7
12.2. Output Saturation Voltage	7
12.3. Output Leakage Current.....	7
12.4. Magnetic Thresholds	7
13. Application Information.....	8
13.1. Typical Three-Wire Application Circuit.....	8
13.2. Two-Wire Circuit.....	8
13.3. Automotive and Harsh, Noisy Environments Three-Wire Circuit	8
14. Application Comments	8
15. Standard information regarding manufacturability of Melexis products with different soldering processes.....	9
16. ESD Precautions	9
17. SE Package Information (TSOT-3L).....	10
18. Contact.....	11
19. Disclaimer.....	11

3. Glossary of Terms

MilliTesla (mT), Gauss	Units of magnetic flux density: 1mT = 10 Gauss
RoHS	Restriction of Hazardous Substances
TSOT	Thin Small Outline Transistor (TSOT package) – also referred with the Melexis package code “SE”
ESD	Electro-Static Discharge

4. Absolute Maximum Ratings

Parameter	Symbol	Value	Units
Supply Voltage	V _{DD}	28	V
Supply Current	I _{DD}	50	mA
Output Voltage	V _{OUT}	28	V
Output Current	I _{OUT}	50	mA
Operating Temperature Range	T _A	-40 to 125	°C
Storage Temperature Range	T _S	-50 to 150	°C
Maximum Junction Temperature	T _J	165	°C

Table 1: Absolute maximum ratings

Exceeding the absolute maximum ratings may cause permanent damage. Exposure to absolute-maximum-rated conditions for extended periods may affect device reliability.

5. Pin Definitions and Descriptions

Pin No	Name	Type	Function
1	VDD	Supply	Supply Voltage pin
2	OUT	Output	Open Drain Output pin
3	GND	Ground	Ground pin

Table 2: Pin definitions and descriptions

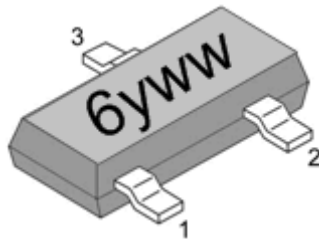

6. General Electrical Specifications

DC Operating Parameters $T_A = 25^\circ\text{C}$, $V_{DD} = 12\text{V}$ (unless otherwise specified)

Parameter	Symbol	Test Conditions	Min	Typ	Max	Units
Supply Voltage	V_{DD}	Operating	3.5		24	V
Supply Current	I_{DD}	$B < B_{RP}$	0.5	2.5	5	mA
Output Saturation Voltage	V_{DSon}	$I_{OUT} = 20\text{mA}$, $B > B_{OP}$		0.3	0.5	V
Output Leakage Current	I_{OFF}	$B < B_{RP}$, $V_{OUT} = 24\text{V}$		0.01	10	μA
Output Rise Time	t_r	$R_L = 1\text{k}\Omega$, $C_L = 20\text{pF}$		0.25		μs
Output Fall Time	t_f	$R_L = 1\text{k}\Omega$, $C_L = 20\text{pF}$		0.25		μs
Output Update Frequency	F_{OUT}			25		kHz
Power-On Time ⁽¹⁾	t_{ON}				100	μs
Package Thermal Resistance	R_{TH}	Single layer (1S) Jedec board		301		$^\circ\text{C}/\text{W}$

Table 3: Electrical specification

7. Magnetic Specifications

DC Operating Parameters $T_A = 25^\circ\text{C}$, $V_{DD} = 12\text{V}$ (unless otherwise specified)

Parameter	Symbol	Test Conditions	Min	Typ	Max	Units
Operating Point	B_{OP}		3.8	5.5	7.2	mT
Release Point	B_{RP}		2	3.5	5	mT
Hysteresis	B_{HYST}		1.5	2	2.7	mT

Table 4: Magnetic specifications

DC Operating Parameters $T_A = -40^\circ\text{C}$ to 125°C (K-version), $T_A = -40^\circ\text{C}$ to 85°C (E-version), $V_{DD} = 12\text{V}$

Parameter	Symbol	Test Conditions	Min	Typ	Max	Units
Operating Point	B_{OP}		3.4		7.7	mT
Release Point	B_{RP}		1.8		5.4	mT
Hysteresis	B_{HYST}		1		2.8	mT

Table 5: Magnetic specifications

¹ The Power-On Time represents the time from reaching the power-on reset level to the first refresh of the output (first valid output state). Value according simulation only, not subject to production test.

8. Output Behaviour versus Magnetic Pole

DC Operating Parameters $T_A = -40^{\circ}\text{C}$ to 125°C , $V_{DD} = 3.5\text{V}$ to 24V (unless otherwise specified)

Parameter	Test Conditions	OUT
South pole	$B > B_{OP}$	Low
Null or weak magnetic field	$B \rightarrow 0$ or $B < B_{RP}$	High
North pole	$B > B_{OP}$	High

Table 6: Output behaviour versus magnetic pole

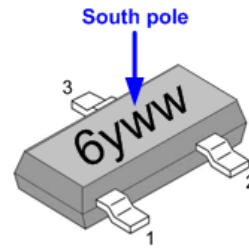

OUT = low (V_{Dson})

9. Detailed General Description

Based on mixed signal CMOS technology, Melexis US5681 is a Hall-effect device with high magnetic sensitivity. Its sensitivity enables high accuracy in position sensing by the use of small air gap.

The Correlated Double Sampling (CDS) technique suppresses the offset generally observed with Hall sensors and amplifiers. The CMOS technology makes this advanced technique possible and contributes to smaller chip size and lower current consumption than bipolar technology. The small chip size is also an important factor to minimize the effect of physical stress. This combination results in more accurate and stable magnetic characteristics, and enables faster and more precise design.

The wide operating voltage from 3.5V to 24V and low current consumption make this device especially suitable for solid state switch applications.

The output signal is open-drain type. Such output allows simple connectivity with TTL or CMOS logic by using a pull-up resistor tied between a pull-up voltage and the device output.

10. Unique Features

The US5681 exhibits unipolar magnetic switching characteristics. Therefore, it operates only with one magnetic pole.

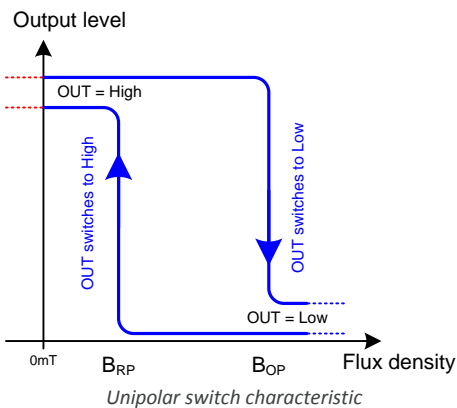

The US5681 device is south pole active:

Applying a south magnetic pole greater than B_{OP} facing the branded side of the package switches the output low.

Removing the magnetic field ($B \rightarrow 0$) switches the output high. The use of the opposite magnetic pole facing the branded side does not affect the output state.

A magnetic hysteresis B_{HYST} keeps B_{OP} and B_{RP} separated by a minimal value. This hysteresis prevents output oscillation near the switching point.

11. Performance Graphs

11.1. Magnetic parameters vs. T_A

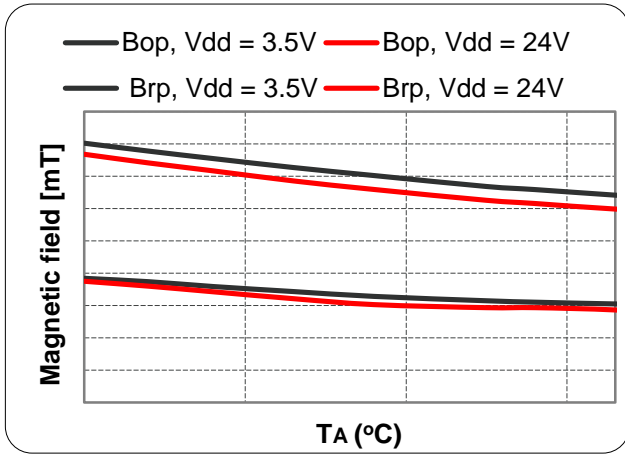

11.2. Magnetic parameters vs. V_{DD}

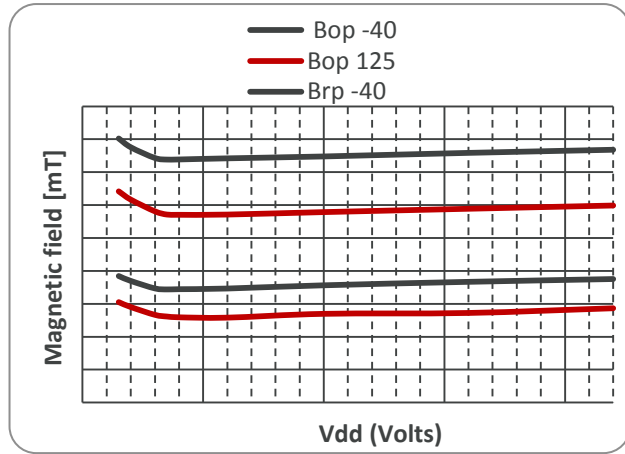

11.3. V_{Dson} vs. T_A

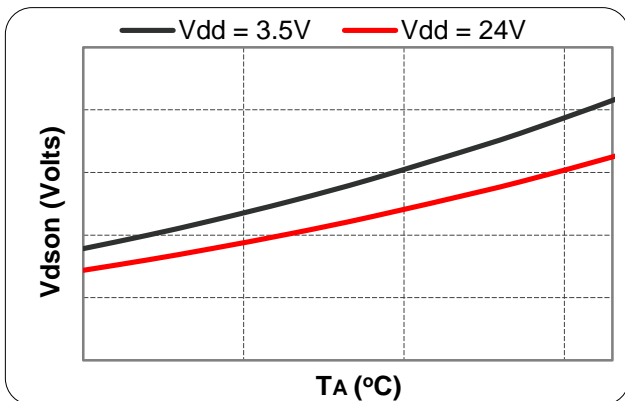

11.4. V_{Dson} vs. V_{DD}

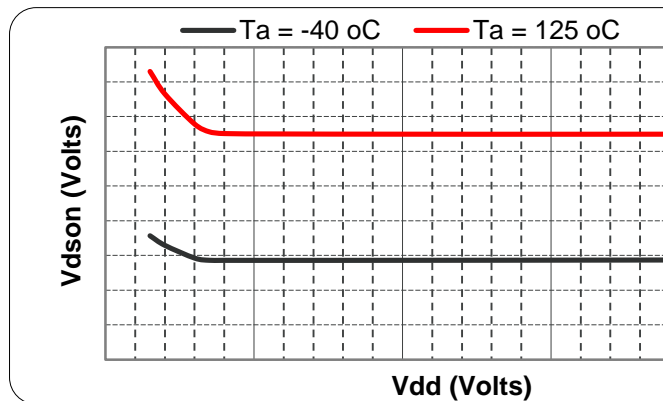

11.5. I_{DD} vs. T_A

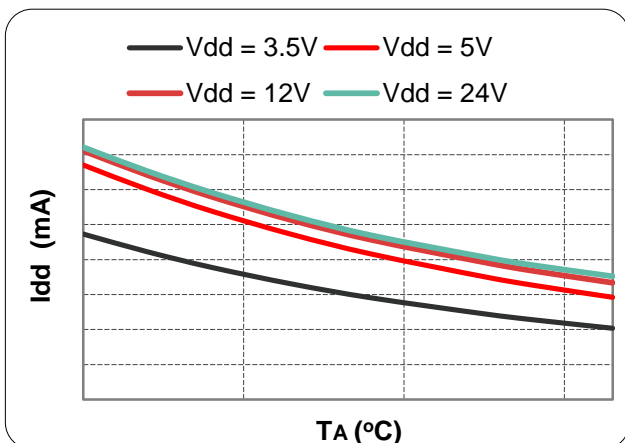

11.6. I_{DD} vs. V_{DD}

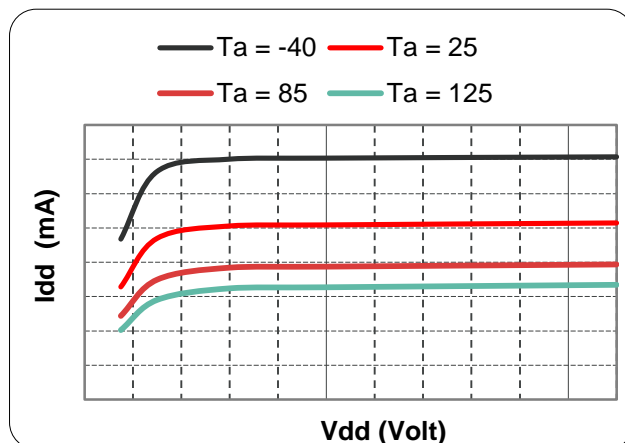

12. Test Conditions

Note : DUT = Device Under Test

12.1. Supply Current

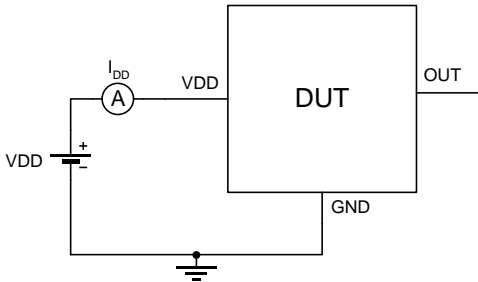

Note 1 - The supply current I_{DD} represents the static supply current. OUT is left open during measurement.

Note 2 - The device is put under magnetic field with $B < B_{RP}$.

12.3. Output Leakage Current

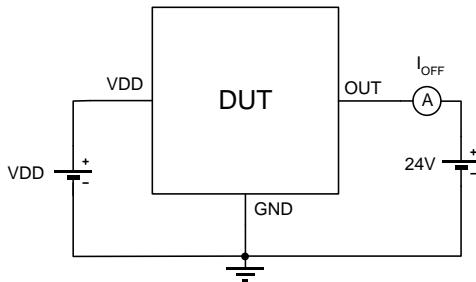

Note 1 - The device is put under magnetic field with $B < B_{RP}$.

12.2. Output Saturation Voltage

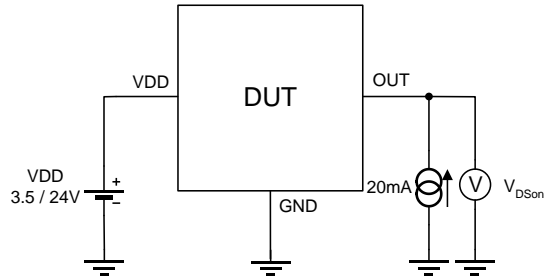

Note 1 - The output saturation voltage V_{DSon} is measured at $V_{DD} = 3.5V$ and $V_{DD} = 24V$.

Note 2 - The device is put under magnetic field with $B > B_{OP}$.

12.4. Magnetic Thresholds

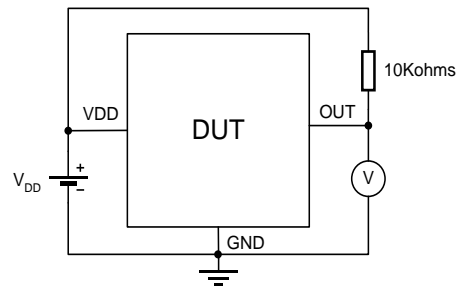

Note 1 - B_{OP} is determined by putting the device under magnetic field swept from B_{RPmin} up to B_{OPmax} until the output is switched on.

Note 2 - B_{RP} is determined by putting the device under magnetic field swept from B_{OPmax} down to B_{RPmin} until the output is switched off.

13. Application Information

13.1. Typical Three-Wire Application Circuit

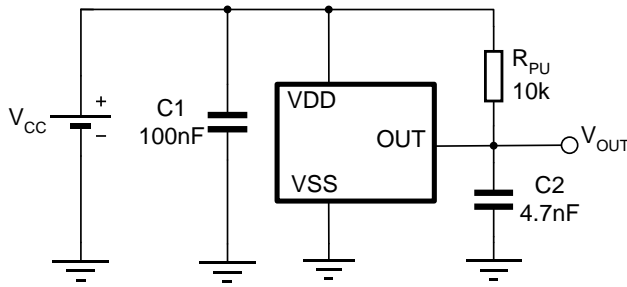

13.2. Two-Wire Circuit

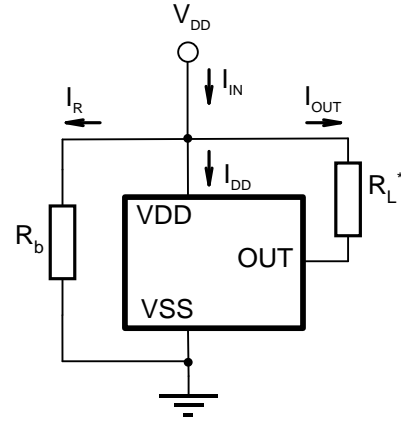

Note:

With this circuit, precise ON and OFF currents can be detected using only two connecting wires.

The resistors R_L and R_b can be used to bias the input current. Refer to the part specifications for limiting values.

$$B_{RP}: I_{OFF} = I_R + I_{DD} = V_{DD}/R_b + I_{DD}$$

$$B_{OP}: I_{ON} = I_{OFF} + I_{OUT} = I_{OFF} + V_{DD}/R_L$$

13.3. Automotive and Harsh, Noisy Environments Three-Wire Circuit

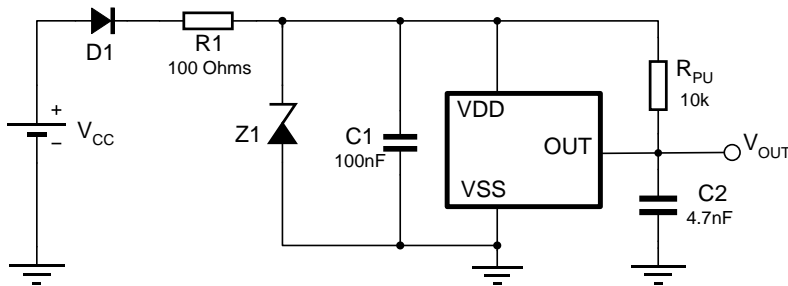

14. Application Comments

For proper operation, a 100nF bypass capacitor should be placed as close as possible to the device between the V_{DD} and ground pin.

For reverse voltage protection, it is recommended to connect a resistor or a diode in series with the V_{DD} pin.

When using a resistor, three points are important:

- the resistor has to limit the reverse current to 50mA maximum ($V_{CC} / R_1 \leq 50\text{mA}$)
- the resulting device supply voltage V_{DD} has to be higher than $V_{DD \text{ min}}$ ($V_{DD} = V_{CC} - R_1 \cdot I_{DD}$)
- the resistor has to withstand the power dissipated in reverse voltage condition ($P_D = V_{CC}^2 / R_1$)

When using a diode, a reverse current cannot flow and the voltage drop is almost constant ($\approx 0.7\text{V}$).

Therefore, a 100 Ω /0.25W resistor for 5V application and a diode for higher supply voltage are recommended. Both solutions provide the required reverse voltage protection.

When a weak power supply is used or when the device is intended to be used in noisy environment, it is recommended that figure 13.3 from the Application Information section is used.

The low-pass filter formed by R_1 and C_1 and the zener diode Z_1 bypass the disturbances or voltage spikes occurring on the device supply voltage V_{DD} . The diode D_1 provides additional reverse voltage protection.

15. Standard information regarding manufacturability of Melexis products with different soldering processes

Our products are classified and qualified regarding soldering technology, solderability and moisture sensitivity level according to following test methods:

Reflow Soldering SMD's (Surface Mount DeVICES)

- IPC/JEDEC J-STD-020
Moisture/Reflow Sensitivity Classification for Nonhermetic Solid State Surface Mount Devices (classification reflow profiles according to table 5-2)
- EIA/JEDEC JESD22-A113
Preconditioning of Nonhermetic Surface Mount Devices Prior to Reliability Testing (reflow profiles according to table 2)

Wave Soldering SMD's (Surface Mount DeVICES) and THD's (Through Hole DeVICES)

- EN60749-20
Resistance of plastic- encapsulated SMD's to combined effect of moisture and soldering heat
- EIA/JEDEC JESD22-B106 and EN60749-15
Resistance to soldering temperature for through-hole mounted devices

Iron Soldering THD's (Through Hole DeVICES)

- EN60749-15
Resistance to soldering temperature for through-hole mounted devices

Solderability SMD's (Surface Mount DeVICES) and THD's (Through Hole DeVICES)

- EIA/JEDEC JESD22-B102 and EN60749-21
Solderability

For all soldering technologies deviating from above mentioned standard conditions (regarding peak temperature, temperature gradient, temperature profile etc) additional classification and qualification tests have to be agreed upon with Melexis.

The application of Wave Soldering for SMD's is allowed only after consulting Melexis regarding assurance of adhesive strength between device and board.

Melexis is contributing to global environmental conservation by promoting **lead free** solutions. For more information on qualifications of **RoHS** compliant products (RoHS = European directive on the Restriction Of the use of certain Hazardous Substances) please visit the quality page on our website: <http://www.melexis.com/quality.aspx>

16. ESD Precautions

Electronic semiconductor products are sensitive to Electro Static Discharge (ESD).
Always observe Electro Static Discharge control procedures whenever handling semiconductor products.

17. SE Package Information (TSOT-3L)

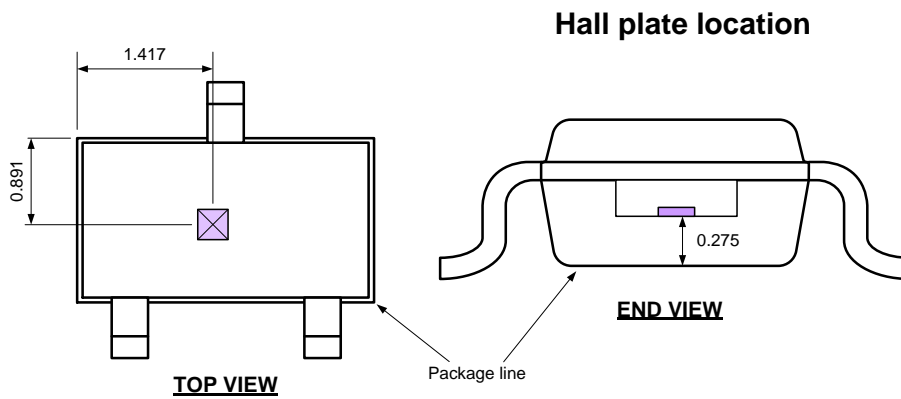
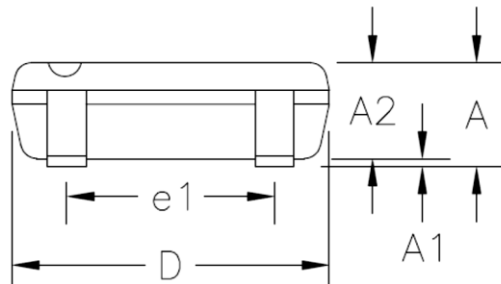
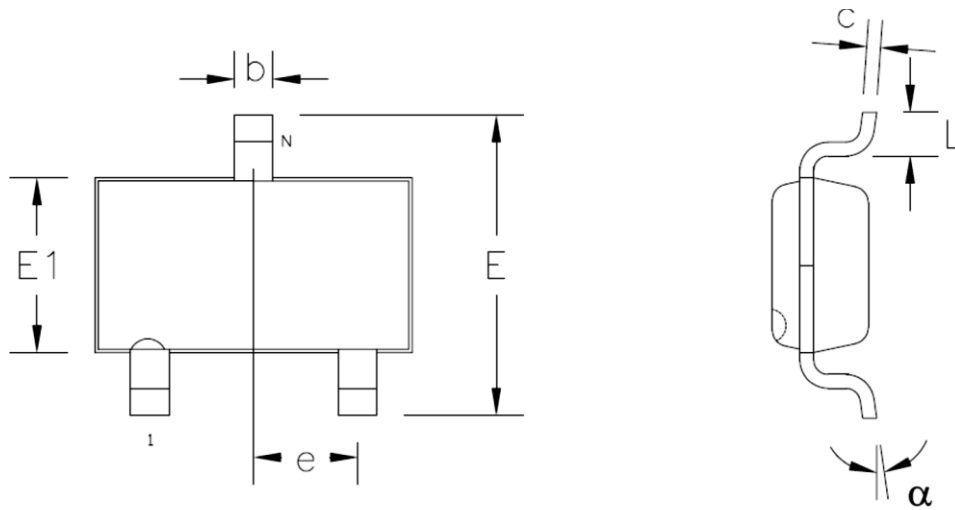

Notes:

1. Dimension "D" and "E1" do not include mold flash or protrusions. Mold flash or protrusion shall not exceed 0.15mm on "D" and 0.25mm on "E" per side.
2. Dimension "b" does not include dambar protrusion.
3. All dimensions are in millimeters

Marking:

Top side : 6yww

6 = part number (US5681)
y = last digit of year
ww = calendar week

This table in mm

	A	A1	A2	D	E	E1	L	b	c	e	e1	α
min	–	0.025	0.85	2.80	2.60	1.50	0.30	0.30	0.10	0.95	1.90	0°
max	1.00	0.10	0.90	3.00	3.00	1.70	0.50	0.45	0.20	BSC	BSC	8°

18. Contact

For the latest version of this document, go to our website at www.melexis.com.

For additional information, please contact our Direct Sales team and get help for your specific needs:

Europe, Africa	Telephone: +32 13 67 04 95
	Email : sales_europe@melexis.com
Americas	Telephone: +1 603 223 2362
	Email : sales_usa@melexis.com
Asia	Email : sales_asia@melexis.com

19. Disclaimer

The information furnished by Melexis herein ("Information") is believed to be correct and accurate. Melexis disclaims (i) any and all liability in connection with or arising out of the furnishing, performance or use of the technical data or use of the product(s) as described herein ("Product") (ii) any and all liability, including without limitation, special, consequential or incidental damages, and (iii) any and all warranties, express, statutory, implied, or by description, including warranties of fitness for particular purpose, non-infringement and merchantability. No obligation or liability shall arise or flow out of Melexis' rendering of technical or other services.

The Information is provided "as is" and Melexis reserves the right to change the Information at any time and without notice. Therefore, before placing orders and/or prior to designing the Product into a system, users or any third party should obtain the latest version of the relevant information to verify that the information being relied upon is current. Users or any third party must further determine the suitability of the Product for its application, including the level of reliability required and determine whether it is fit for a particular purpose.

The Information is proprietary and/or confidential information of Melexis and the use thereof or anything described by the Information does not grant, explicitly or implicitly, to any party any patent rights, licenses, or any other intellectual property rights.

This document as well as the Product(s) may be subject to export control regulations. Please be aware that export might require a prior authorization from competent authorities.

The Product(s) are intended for use in normal commercial applications. Unless otherwise agreed upon in writing, the Product(s) are not designed, authorized or warranted to be suitable in applications requiring extended temperature range and/or unusual environmental requirements. High reliability applications, such as medical life-support or life-sustaining equipment are specifically not recommended by Melexis.

The Product(s) may not be used for the following applications subject to export control regulations: the development, production, processing, operation, maintenance, storage, recognition or proliferation of 1) chemical, biological or nuclear weapons, or for the development, production, maintenance or storage of missiles for such weapons; 2) civil firearms, including spare parts or ammunition for such arms; 3) defense related products, or other material for military use or for law enforcement; 4) any applications that, alone or in combination with other goods, substances or organisms could cause serious harm to persons or goods and that can be used as a means of violence in an armed conflict or any similar violent situation.

The Products sold by Melexis are subject to the terms and conditions as specified in the Terms of Sale, which can be found at <https://www.melexis.com/en/legal/terms-and-conditions>.

This document supersedes and replaces all prior information regarding the Product(s) and/or previous versions of this document.

Melexis NV © - No part of this document may be reproduced without the prior written consent of Melexis. (2016)

ISO/TS 16949 and ISO14001 Certified

X-ON Electronics

Largest Supplier of Electrical and Electronic Components

Click to view similar products for [Board Mount Hall Effect/Magnetic Sensors](#) category:

Click to view products by [Melexis](#) manufacturer:

Other Similar products are found below :

[HGPRDT005A](#) [AH277AZ4-AG1](#) [AV-10379](#) [AV-10448](#) [SS41C](#) [AH1894-Z-7](#) [ATS601LSGTN-LT-WU4-T](#) [TLE4917](#) [50017859-003](#) [TY-13101](#) [TLE4976L](#) [AH49FNTR-G1](#) [SS85CA](#) [AH277AZ4-BG1](#) [TLE49614MXTSA1](#) [AH3377-P-B](#) [AH211Z4-AG1](#) [AH3360-FT4-7](#) [SS460S-100SAMPLE](#) [50065820-03](#) [TLE4941PLUSCB](#) [AH374-P-A](#) [AH1806-P-A](#) [AH374-W-7](#) [SS460P-T2](#) [AH1913-W-7](#) [SS413F](#)
[TLE5046ICAKLRHALA1](#) [TLE49421CHAMA2](#) [TLE4941PLUSCXAMA1](#) [AH1912-W-EVM](#) [AH1903-FA-EVM](#) [AH3774-W-EVM](#)
[AH49FNTR-EVM](#) [MMC5633NJL](#) [AH3360-FA-EVM](#) [AH8502-FDC-EVM](#) [AH3366Q-SA-EVM](#) [AH3774-P-EVM](#) [KTH1601SU-ST3](#)
[MG910](#) [MG910M](#) [MG911](#) [MG610](#) [MW921](#) [MW922](#) [TLE4998S3XALA1](#) [TLE5011FUMA1](#) [TLE5027CE6747HAMA1](#)
[TLE5109A16E2210XUMA1](#)