



Low Cost ±1.5 g Tri Axis Accelerometer with Ratiometric Outputs

MXR9500G/M

FEATURES

- Low cost
- RoHS compliant
- Resolution better than 1 mg
- Tri-axis accelerometer in a single package.
- On chip mixed signal processing
- No moving parts
- No loose particle issues
- >50,000 g shock survival rating
- SMT package: 7mm X 7mm X 1.8mm
- 2.7V to 3.6V single supply continuous operation
- No adjusting external components needed

APPLICATIONS

- GPS** – Electronic Compass Tilt Correction/Navigation
- Consumer** – LCD projectors, pedometers, blood pressure monitor, digital cameras/MP3 players
- Information Appliances** – Computer Peripherals/PDA's/Cell Phones
- Gaming** – Joystick/RF Interface/Menu Selection/Tilt Sensing
- Security** – Gas Line/Elevator/Fatigue Sensing

GENERAL DESCRIPTION

The MXR9500G/M is a low cost, tri axis accelerometer fabricated on a standard, submicron CMOS process. It is a complete sensing system with on-chip mixed signal processing. The MXR9500G/M measures acceleration with a full-scale range of ±1.5 g and a sensitivity of 500mV/g @3.0V at 25°C. It can measure both dynamic acceleration (e.g. vibration) and static acceleration (e.g. gravity). The MXR9500G/M design is based on heat convection and requires no solid proof mass. This eliminates stiction and particle problems associated with competitive devices and provides shock survival greater than 50,000 g, leading to significantly lower failure rate and lower loss due to handling during PCB assembly and at customer field application.

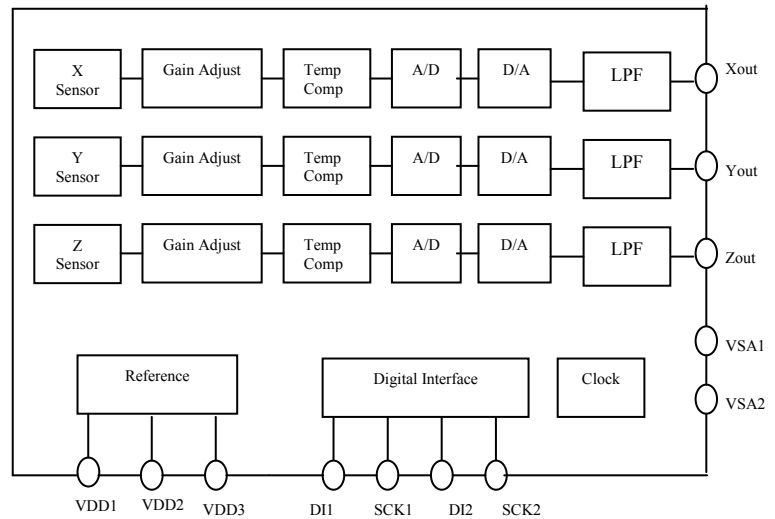

FUNCTIONAL BLOCK DIAGRAM

The MXR9500G/M provides three ratiometric analog outputs that are set to 50% of the power supply voltage at zero g.

The Max. noise floor is $1 \text{ mg}/\sqrt{\text{Hz}}$ allowing signals below 1mg to be resolved at 1 Hz bandwidth. The MXR9500G/M is packaged in a hermetically sealed, surface mount LCC 16pins package (7 mm x 7 mm x 1.8 mm height) and is operational over a -40°C to +85°C (M) and 0°C to +70°C (G) temperature range.

I²C fast mode interface is soon available in the next generation chip.

Information furnished by MEMSIC is believed to be accurate and reliable. However, no responsibility is assumed by MEMSIC for its use, nor for any infringements of patents or other rights of third parties which may result from its use. No license is granted by implication or otherwise under any patent or patent rights of MEMSIC.

©MEMSIC, Inc.
One Technology Drive Suite 325, Andover MA01810, USA
Tel: +1 978 738 0900 Fax: +1 978 738 0196
www.memsic.com

MXR9500G/M SPECIFICATIONS (Measurements @ 25°C, Acceleration = 0 g unless otherwise noted; VDD1, VDD3 = 3.0V unless otherwise specified)

Parameter	Conditions	Min	Typ	Max	Units
Measurement Range ¹	Each Axis	±1.5			g
Nonlinearity	Best fit straight line		0.5	1.0	% of FS
Alignment Error ²	X, Y-axis Z-axis		± 1.0 ± 3.0		degrees degrees
Transverse Sensitivity ³			± 2.0		%
Sensitivity		475	500	525	mV/g
Sensitivity Change Over Temperature	Δ from 25°C		15		%
Zero g Offset Bias Level		1.45	1.50	1.55	V
		-0.1	0.0	+0.1	g
Zero g Offset TC	Δ from 25°C, based on 500mV/g X,Y-axis Z-axis		1.0 1.5		mg/°C mg/°C
Normal Output Range	Output High	2.8			V
	Output Low			0.2	V
Noise Density, RMS	X,Y-axis		0.6		mg/√Hz
	Z-axis		0.9		mg/√Hz
Resolution	@1Hz BW		0.5	1	mg
Frequency Response	@-3dB		17		Hz
Output Drive Capability	@2.7V-3.6V			100	μA
Turn-On Time ⁴			75		mS
Operating Voltage Range		2.7	3.0	3.6	V
Supply Current			4.2		mA
Power Down Current				0.1	uA
Operating Temperature Range	MXR9500G	0		+70	°C
	MXR9500M	-40		+85	°C

NOTES

¹ Guaranteed by measurement of initial offset and sensitivity.

² Alignment error is specified as the angle between the true and indicated axis of sensitivity.

³ Cross axis sensitivity is the algebraic sum of the alignment and the inherent sensitivity errors.

⁴Output settled to within ±17mg.

ABSOLUTE MAXIMUM RATINGS*

Supply Voltage (V_{DD})-0.5 to +7.0V
 Storage Temperature-65°C to +150°C
 Acceleration50,000 g

*Stresses above those listed under Absolute Maximum Ratings may cause permanent damage to the device. This is a stress rating only; the functional operation of the device at these or any other conditions above those indicated in the operational sections of this specification is not implied. Exposure to absolute maximum rating conditions for extended periods may affect device reliability.

Pin Description: LCC-16 Package

Pin	Name	Description	I/O
1	NC	Do Not Connect	NC
2	Zout	Z Channel Output	O
3	VSA2	Connect to Ground	I
4	VDD1	2.7V to 3.6V	I
5	DI1	Power Down Pin	I
6	SCK1	Connect to Ground	I
7	NC	Do Not Connect	NC
8	VSA1	Connect to Ground	I
9	NC	Do Not Connect	NC
10	NC	Do Not Connect	NC
11	VDD2	2.7V to 3.6V	I
12	Yout	Y Channel Output	O
13	Xout	X Channel Output	O
14	VDD3	2.7V to 3.6V	I
15	SCK2	Connect to Ground	I
16	DI2	Power Down Pin	I

Ordering Guide

Model	Temperature Range	Package
MXR9500GZ	0 to 70°C	LCC16, RoHS compliant
MXR9500MZ	-40 to 85°C	LCC16, RoHS compliant

All parts are shipped in tape and reel packaging.

Caution: ESD (electrostatic discharge) sensitive device.

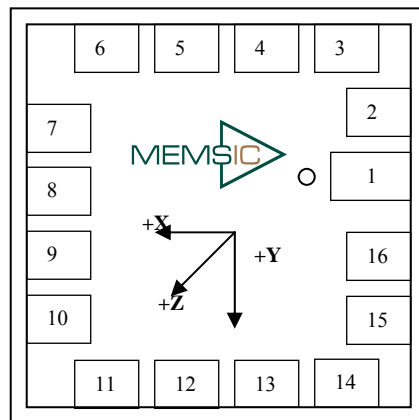
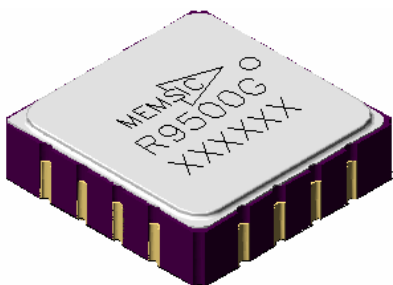

(Top View)

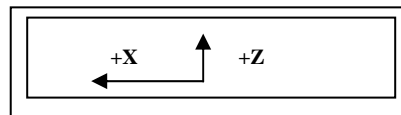

(Side View)

Note: Small circle indicates pin one (1).

THEORY OF OPERATION

The MEMSIC device is a complete tri-axis acceleration measurement system in a single package fabricated on CMOS IC process. The device operation is based on heat transfer by natural convection and operates like other accelerometers having a proof mass except it is a gas in MEMSIC sensor.

Heat source, centered in the silicon chip is suspended across a cavity. Equally spaced aluminum/polysilicon thermopiles (groups of thermocouples) are located equidistantly on all four sides of the heat source. Under zero acceleration, a temperature gradient is symmetrical about the heat source, so that the temperature is the same at all four thermopiles, causing them to output the same voltage.

Acceleration in any direction will disturb the temperature profile, due to free convection heat transfer, causing it to be asymmetrical. The temperature, and hence voltage output of the four thermopiles will then be different. The differential voltage at the thermopile outputs is directly proportional to the acceleration. Please visit the MEMSIC website at www.memsic.com for a picture/graphic description of the free convection heat transfer principle.

TYPICAL CHARACTERISTICS, % OF UNITS (@ 25°C, V_{DD} = 3.0V)

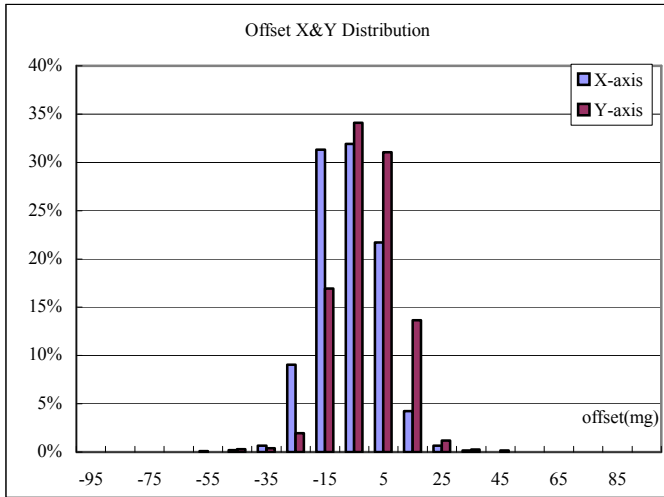

0g X&Y Offset Deviation

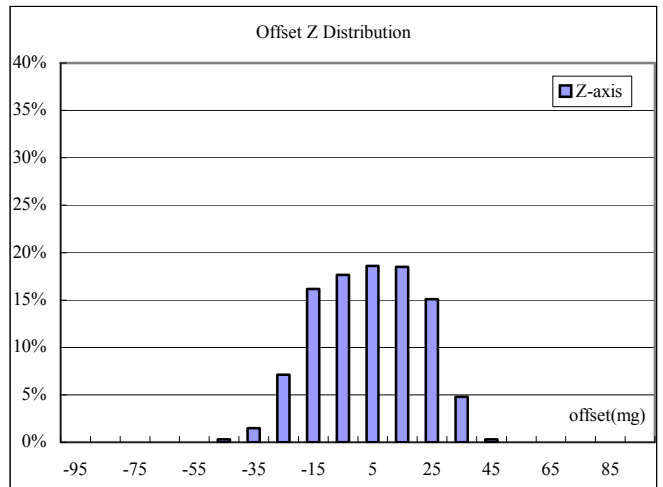

0g Z Offset Deviation

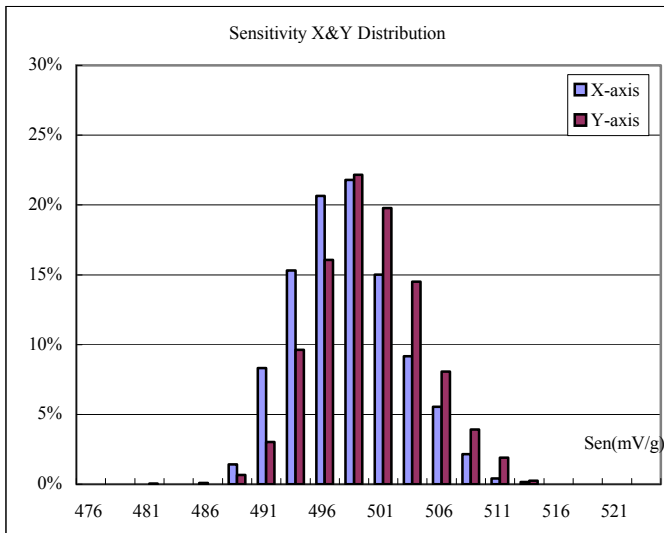

X&Y Axis Sensitivity Distribution

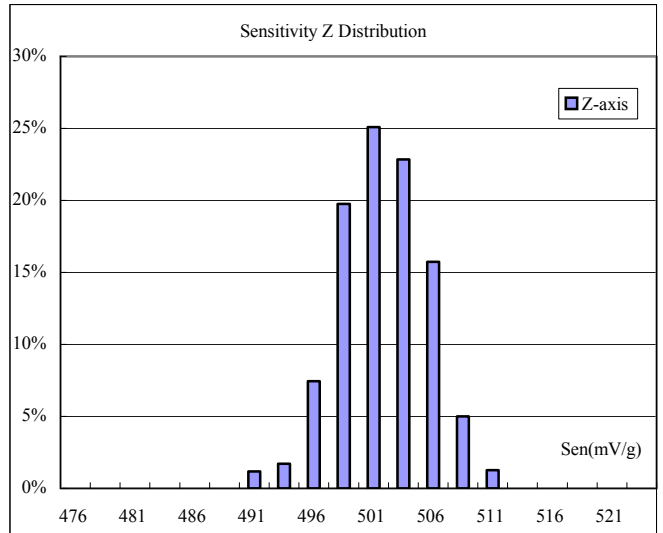

Z Axis Sensitivity Distribution

OVER TEMPERATURE CHARACTERISTICS

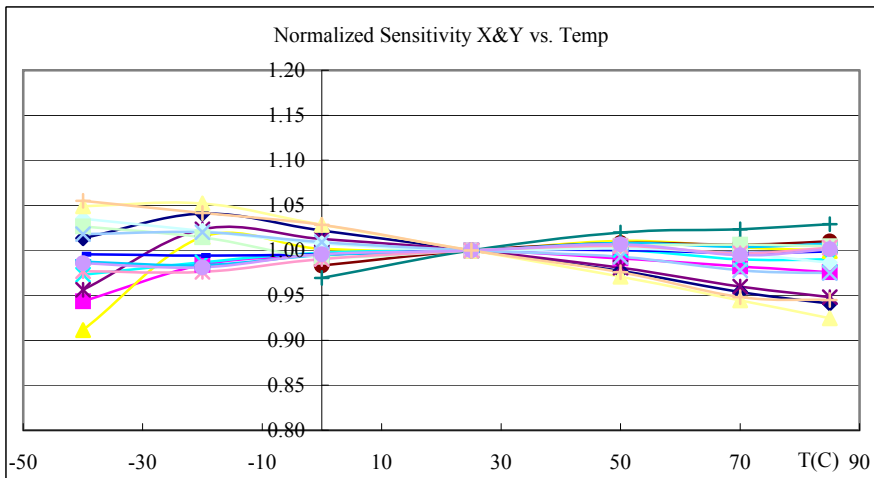
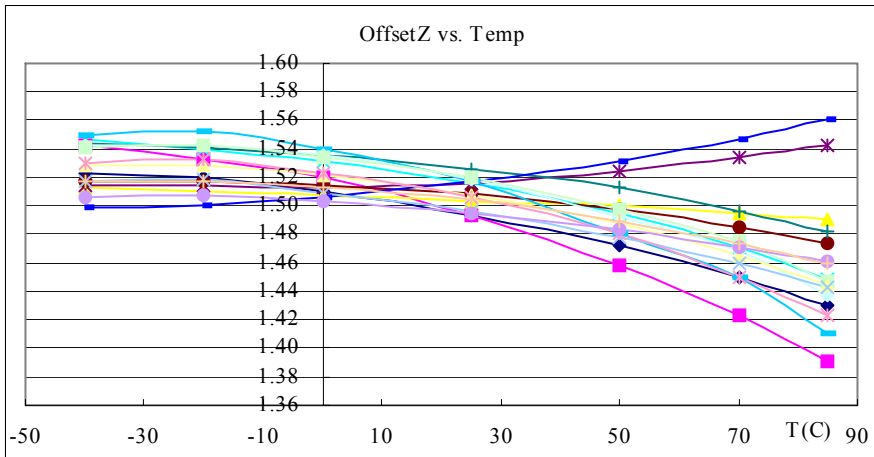
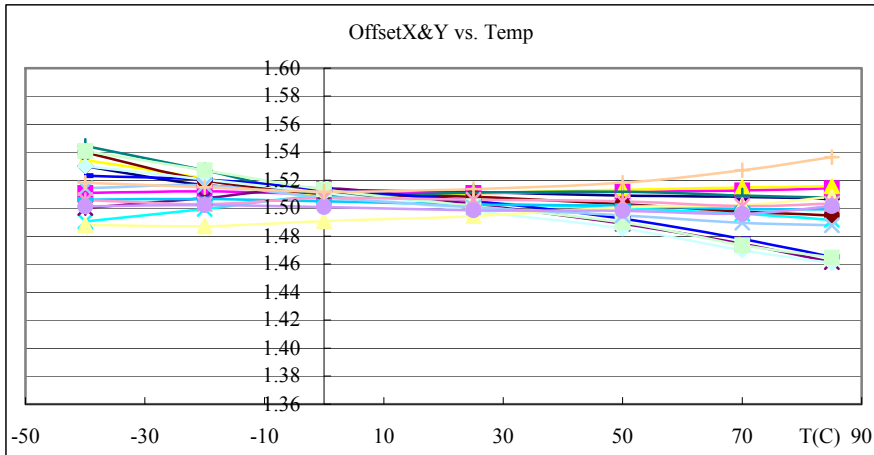

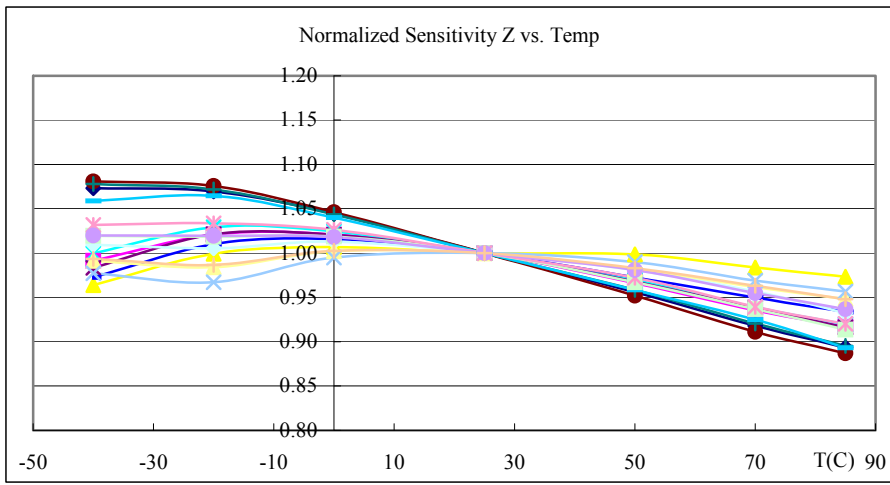

MXR9500G/M PIN DESCRIPTIONS

VDD1, VDD2, VDD3– These pins are the supply input for the circuits and the sensor heater in the accelerometer. The DC voltage should be between 2.7 and 3.6 volts. Refer to the section on PCB layout and fabrication suggestions for guidance on external parts and connections recommended.

VSA1, VSA2– These pins are ground pin for the accelerometer.

SCK1, SCK2– These pins are for factory used only, should be connect to ground.

DI1, DI2– These pins are the power down control pin. Pull these pins HIGH will put the accelerometer into power down mode. When the part goes into power down mode, the total current will be smaller than 0.1uA at 3V.

In normal operation mode, this pin should be connected to Ground.

Xout – This pin is the analog output of the X-axis acceleration sensor.

Yout – This pin is the analog output of the Y-axis acceleration sensor

Zout – This pin is the analog output of the Z-axis acceleration sensor.

POWER SUPPLY NOISE REJECTION

One capacitor is recommended for best rejection of power supply noise. The capacitor should be located as close as possible to the device supply pin (VDD1,VDD3). The capacitor lead length should be as short as possible, and surface mount capacitor is preferred. For typical applications, the capacitor can be ceramic 0.1 μ F.

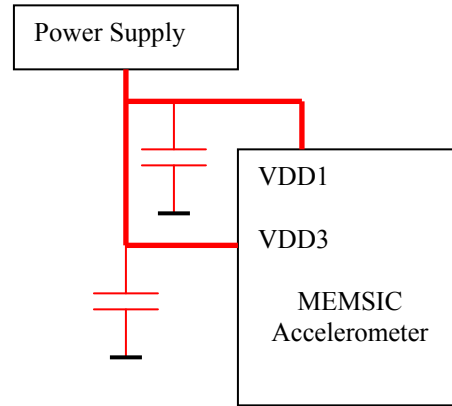

PCB LAYOUT AND FABRICATION SUGGESTIONS

1. It is best to solder a 0.1uF capacitor directly across VDD1, VSA1 and VDD3, VSA2 pin.
2. Robust low inductance ground wiring should be used.

PACKAGE DRAWING

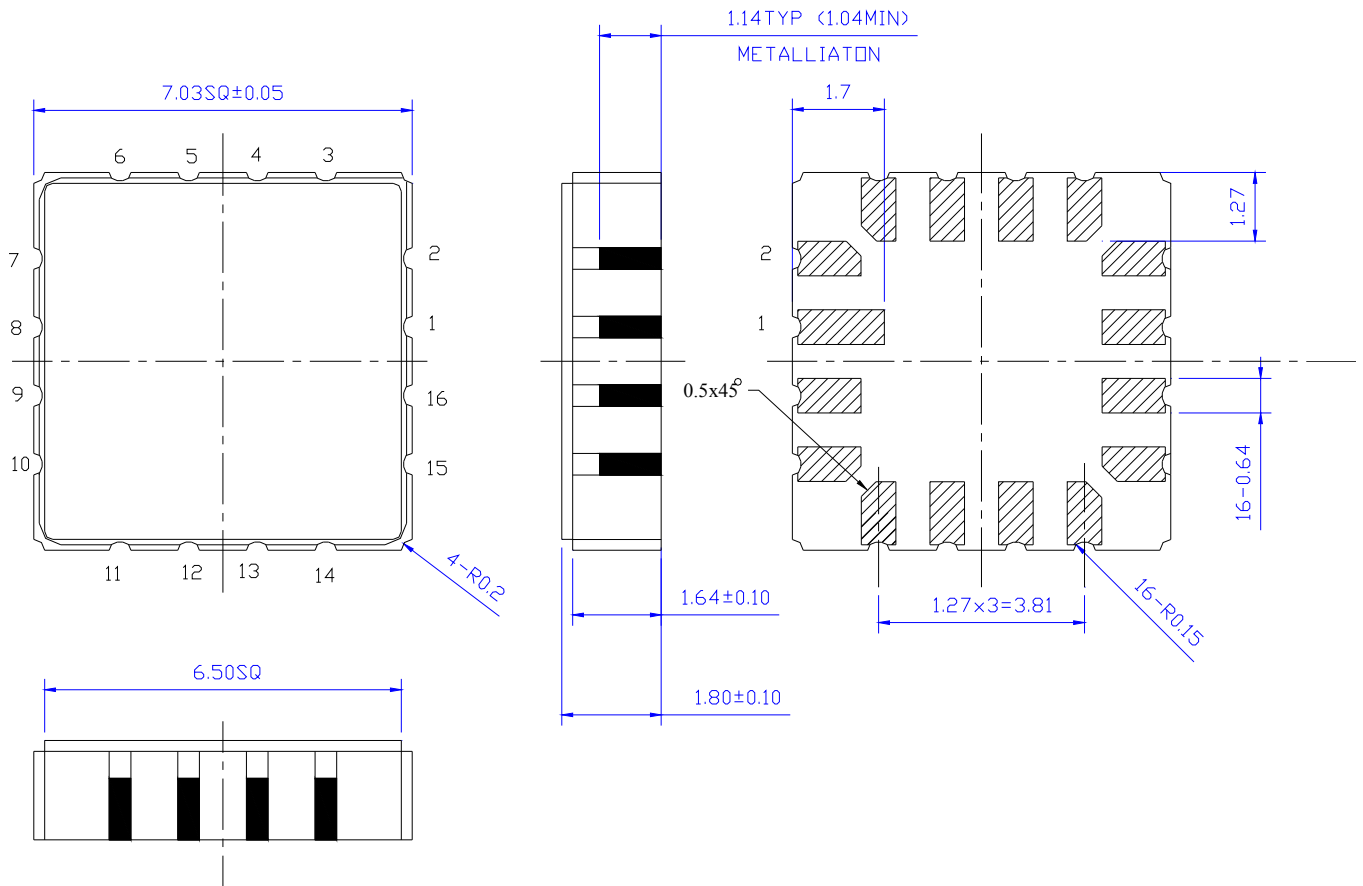

X-ON Electronics

Largest Supplier of Electrical and Electronic Components

Click to view similar products for [Accelerometers](#) category:

Click to view products by [Memsic](#) manufacturer:

Other Similar products are found below :

[AD22372Z-RL7](#) [ADXL313WACPZ-RL](#) [805M1-0050-01](#) [MXC6655XA](#) [MMA7455LT](#) [805M1-0200-01](#) [810M1-0025X](#) [832M1-0200](#)
[AIS328DQTR](#) [832M1-0050](#) [805-0050](#) [AD22301](#) [BMA253](#) [SCA620-EF8H1A-1](#) [MC3413](#) [MXC6244AU](#) [3038-0500](#) [ACH-01-04/10](#) [4692](#)
[ADXL372BCCZ-RL7](#) [735T](#) [787-500](#) [787AM8](#) [793-6](#) [793L](#) [997-M4](#) [HV101](#) [HV102](#) [HV200](#) [PC420AR-10](#) [PC420VP-50](#) [786A](#) [786A-IS](#)
[787A](#) [787A-IS](#) [HT786A](#) [HT787A](#) [PC420VP-10](#) [AD22293Z-RL7](#) [ADIS16003CCCZ](#) [ADIS16228CMLZ](#) [ADXL700WBRWZ-RL](#)
[ADXL1003BCPZ](#) [ADXL103CE-REEL](#) [ADXL203CE-REEL](#) [ADXL206HDZ](#) [ADXL213AE](#) [ADXL288WBRDZ-RL](#) [ADXL295WBRDZ-RL](#)
[ADXL312WACPZ](#)