

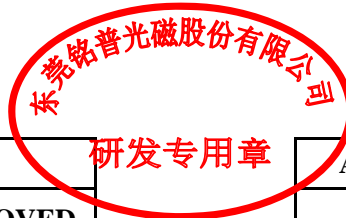



Product Specification for Approval

WE ARE PLEASED IN SUBMITTING OUR SAMPLES WITH SPECIFICATION TO YOU FOR APPROVAL.

CUSTOMER	:		
DESCRIPTION	:	10/100/1000 BASE-T DUAL PORT SURFACE MOUNT MAGNETICS	
MNC P/N	:	G4818CG	
VERSION	:	A0	
CUSTOMER P/N	:		
ISSUED DATE	:	2020/04/27	
PHOTO OF PRODUCT	:		
WEIGHT	:		5.68g
MADE IN	:		CHINA



APPROVED BY MNC			APPROVED BY CUSTOMER
PREPARED BY 	CHECKED BY 	APPROVED BY 	SIGNATURE OR STAMP

1. PLEASE SEND BACK US A COPY OF THE SPECIFICATION WITH YOUR STAMP OR SIGNATURE ONCE THE SAMPLES APPROVED.
2. IT WILL BE DEEMED THE SAMPLES TO BE APPROVED IF NO FEEDBACK.

东莞铭普光磁股份有限公司
 Add: Shipai Town, Dongguan City, Guangdong Province, China

TEL: +86-769-86921000
 FAX: +86-769-81701563

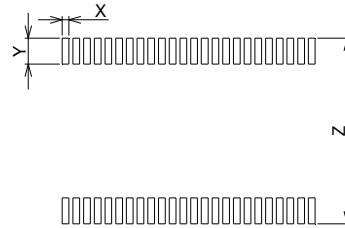
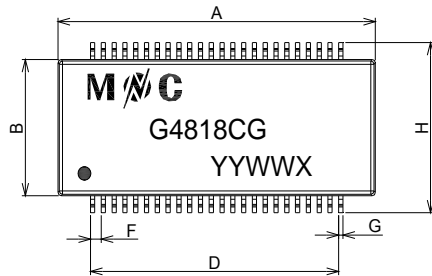
SPECIFICATION
Part No. G4818CG
A. MECHANICAL :

SUGGESTED PAD LAYOUT

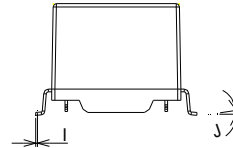
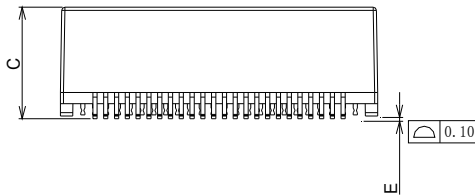

Note: Laser printing marking

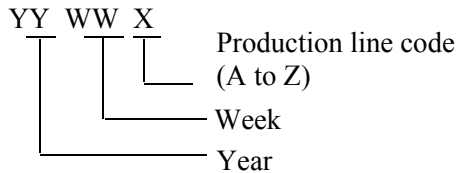

1. UNITS: mm/inch.
2. UNLESS OTHERWISE SPECIFIED ALL TOLERANCES ARE: TYPICAL
3. PIN LENGTH DON'T INCLUDE SOLDER POINT

DIM	MILLIMETERS			INCHES		
	MIN	NOM	MAX	MIN	NOM	MAX
A	29.50	30.00	30.50	1.161	1.181	1.201
B	11.70	12.20	12.70	0.461	0.480	0.500
C	9.50	10.00	10.50	0.374	0.394	0.413
D	/	23.46	/	/	0.924	/
E	0.15	0.30	0.45	0.006	0.012	0.018
F	0.52	1.02	1.52	0.020	0.040	0.060
G	0.30	0.40	0.50	0.012	0.016	0.020
H	14.74	15.24	15.74	0.580	0.600	0.620
I	/	1.02	/	/	0.040	/
J	0°	/	8°	0°	/	8°
X	/	0.64	/	/	0.025	/
Y	/	2.34	/	/	0.092	/
Z	/	16.44	/	/	0.647	/

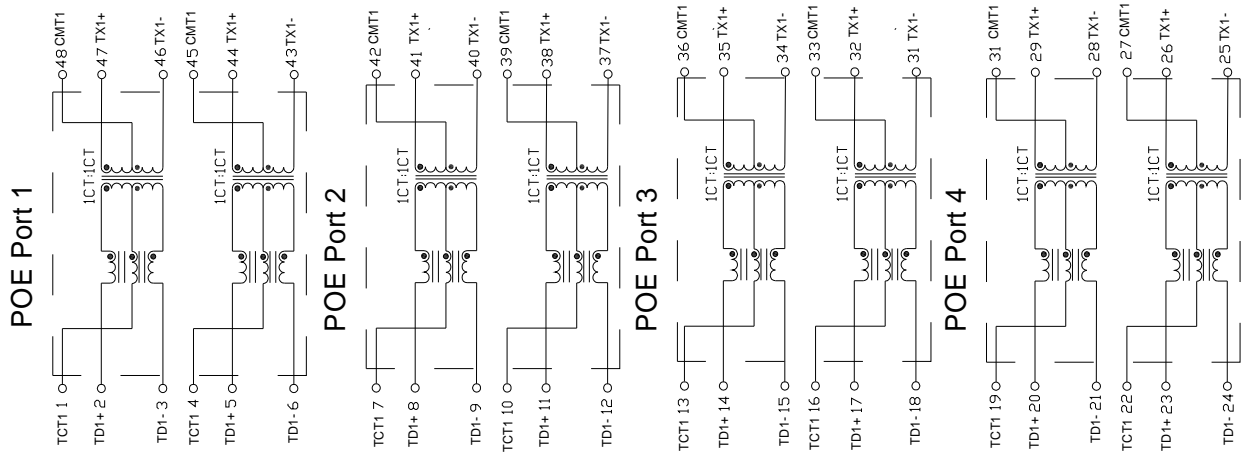
SPECIFICATION
Part No. G4818CG
B. SCHEMATIC :

C. ELECTRICAL SPECIFICATION @25°C

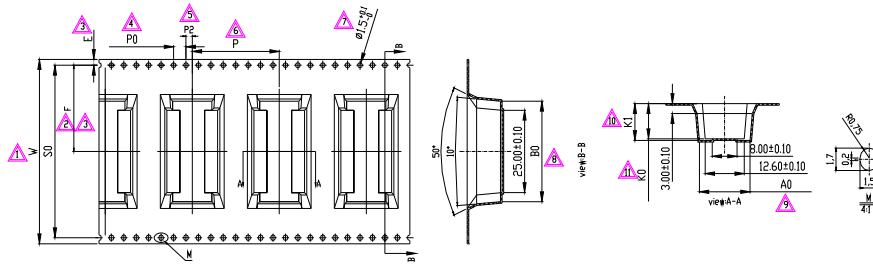
ITEM	SPECIFICATION	TEST CONDITION	TEST EQUIPMENT
INDUCTANCE :	350uH MIN.	100KHz 0.2V 21mA DC Bias	TH2819XB OR EQU.
LEAKAGE INDUCTANCE :	0.50uH MAX.	100KHz 0.2V	TH2819XB OR EQU.
INTERWINDING CAPACITANCE :	25pF TYP.	100KHz 0.2V	TH2819XB OR EQU.
DC RESISTANCE :	1.6Ω MAX.	AT 25 °C	TOS 8020 OR EQU.
TURNS RATIO :	1CT:1CT±5%		TH2819XB OR EQU.
POLARITY :	2-47,5-44,8-41,11-38,14-35,17-32,20-29,23-26 IN-PHASE		
INSERTION LOSS :	-0.2-0.002*f ^{1.4} MAX.	1-100MHz	E5061A OR EQU.
RETURN LOSS :	-16dB MIN.	1-40 MHz	E5061A OR EQU.
	-10+20log(f/80)dB MIN.	40.1-100 MHz	
CROSS TALK :	-35dB MIN.	0.5-40 MHz	E5061A OR EQU.
	-33+20*log(f/50)dB MIN.	40.1-100 MHz	
CMRR :	-30dB MIN.	0.5-100 MHz	E5061A OR EQU.
ISOLATION HI-POT :PRI TO SEC	1500VAC	1mA,60S	7152AB OR EQU.
	1650VAC	1mA,6S	
OPERATING TEMPERATURE:	0°C TO 70°C		

PACKAGE
Part No. G4818CG
D. PACKING:
a. PACKAGING AS BELOW (ONLY FOR A REFERENCE):

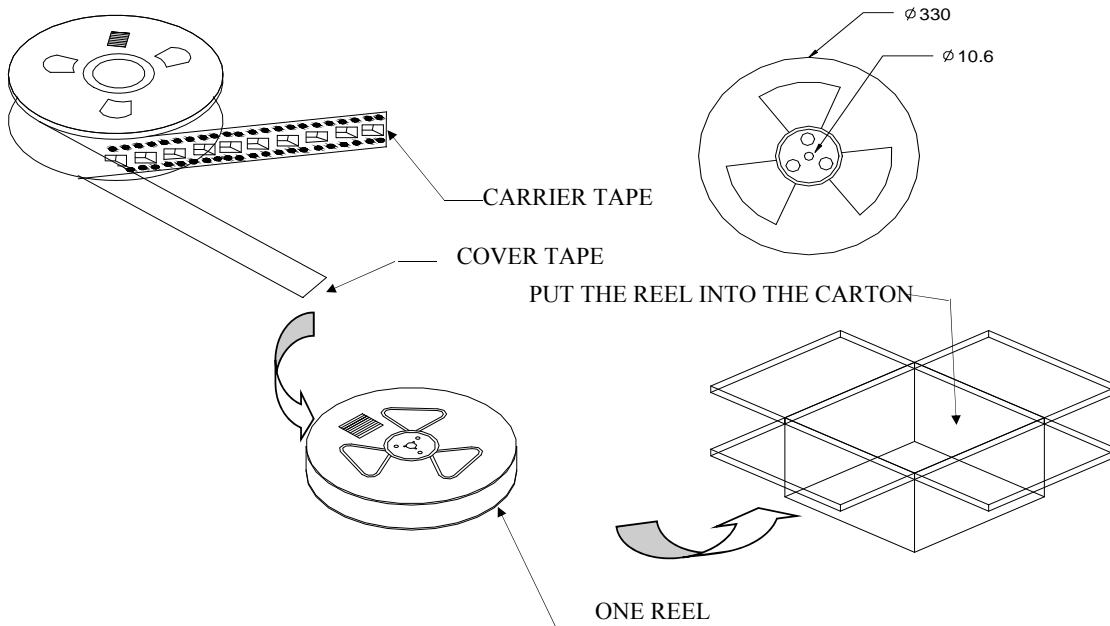
ITEM	W	A ₀	B ₀	K ₀	K ₁	P	F	S ₀	E	D ₀	D ₁	P ₀	P ₂
DIM	56.00±0.30	16.30±0.10	30.50±0.10	10.50±0.10	11.00±0.10	28.00±0.10	26.20±0.15	52.40±0.10	1.75±0.10	$\phi 1.50_{-0.10}^{+0.10}$	—	4.00±0.10	2.00±0.15

b. Q'TY:

180 PCS PER REEL
 4 REELS PER CARTON
 720 PCS PER CARTON

c. LABEL:

REMARK:

ABOVE PACKING IS FOR YOUR REFERENCE ONLY, WHICH MIGHT BE CHANGED WITHOUT NOTICE.

MATERIAL LIST
Part No. G4818CG
E.BOM

MATERIAL LIST					
NO.	ITEM	MATERIAL	RATING	SUPPLIER OF MATERIAL	UL
1	CORE	Mn-Zn	-----	YEAN SHING	N/A
			-----	ZHONGSHAN CRC ELECTRONICS FACTORY	N/A
		Ni-Zn	-----	YEAN SHING	N/A
			-----	ZHONGSHAN CRC ELECTRONICS FACTORY	N/A
2	COPPER WIRE	QPN180	180℃	ZHUHAI SUNTEK WIRE CO.,LTD	E234867
		Polysol 180	180℃	ELEKTRISOLA(MALAYSIA) SDN.BHD.	E258243
3	CASE	WH-9100	V-0	WAH HONG INDUSTRIAL CORP	E150608
4	PIN	C5191	-----	SHENZHEN MINGSCHIN INDUSTRIAL MATERIAL CO.,LTD	N/A

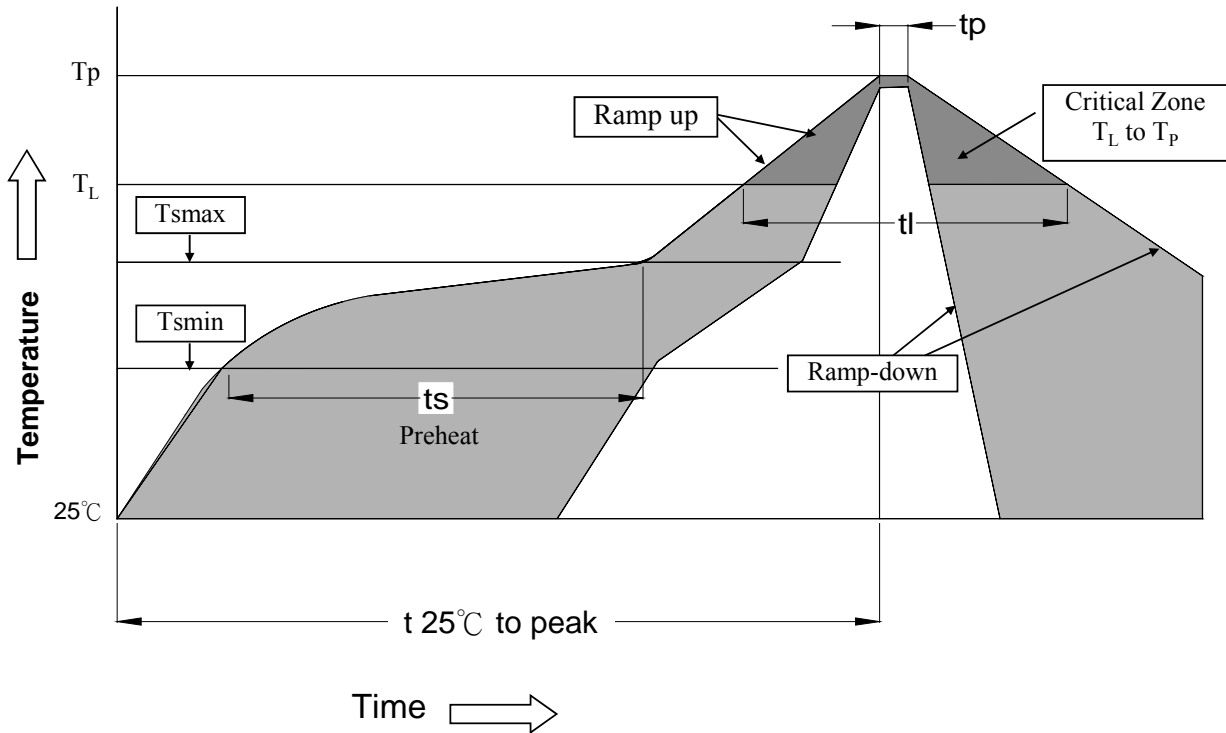
RECOMMENDED SOLDERING PROFILE
Part No. G4818CG
a. RECOMMENDED REFLOW SOLDERING PROFILE:

 $T_L = 217^\circ\text{C}$
 $T_p = 245^\circ\text{C}$
 $t_s = 60-180\text{s}$ $T_s \text{ max} = 200^\circ\text{C}$ $T_s \text{ min} = 150^\circ\text{C}$
 $t_L = 60-150\text{s}$ $t_p = 20-40\text{s}$ $T_{25^\circ\text{C to peak}} = 8\text{min max}$

 Ramp up rate = 3°C/s max

 Ramp down rate = 6°C/s max

*RoHS Compliant

*Solder Paste SAC 305 Sn 96.5/Ag 3.0/Cu 0.5

*Silkscreen thickness: 0.15mm Min

b. MOISTURE SENSITIVE LEVEL:

b.1. LEVEL: 1

b.2. SHELF LIFE: UNLIMITED

 b.3. STORAGE CONDITION: $\leq 30^\circ\text{C}/85\% \text{ RH}$

X-ON Electronics

Largest Supplier of Electrical and Electronic Components

Click to view similar products for [Audio Transformers](#) / [Signal Transformers](#) category:

Click to view products by [Mentech](#) manufacturer:

Other Similar products are found below :

[CU4S0506AT-2655-H1](#) [MGPWT-00449-P](#) [PE-64961](#) [1812WBT2-4](#) [BX1194WNL](#) [1879479-1](#) [PA1528ANL](#) [T1137NLT](#) [T3012NL](#) [PE-65848FNLT](#) [H5019EFNL](#) [CX2045ALNLT](#) [MET-14](#) [MGPWT-00059-P](#) [MGPWT-00266-P](#) [MGPWT-00278-P](#) [MGPWT-00431-P](#) [TTC-100](#) [TTC-143-H](#) [TTC-5032-1](#) [4-1879391-0](#) [100213](#) [T1142NL](#) [T1124NL](#) [1879732-1](#) [2-1879391-5](#) [B8846NL](#) [MABA-010321-CT1A42](#) [TX1341NL](#) [H0013FNL](#) [H5020FNL](#) [H2009FNLT](#) [H5004NLT](#) [S553-5999-52-F](#) [T5008NLT](#) [PE-68517T](#) [TG111-E212NWLFR](#) [MGPWT-00339-P](#) [H5014FNLT](#) [TX1473NLT](#) [PE-69011NLT](#) [CX2043LNLT](#) [H7137FNLT](#) [H1259NLT](#) [TX1344NLT](#) [LM-LP-1005L](#) [H0013NLT](#) [S558-5500-JV](#) [TX1193NLT](#) [T7015NL](#)