

THT LED-Anzeigesysteme

THT LED Display Systems

In die Entwicklung dieser Bauteile ist das über Jahrzehnte erworbene Know-how der Firma MENTOR als Entwickler und Lieferant von Bauelementen für die Industrielektronik geflossen. Der Einsatz ist überall dort zu suchen, wo Lichtsignale auf Funktionen oder Betriebszustände aufmerksam machen sollen und müssen. Die Vielfalt der Bauelemente erstreckt sich von Einzel- und Mehrfachanzeigen sowie Leisten in unterschiedlichsten Ausführungen bis hin zu Lampenfassungen.

Bei den mit FEL gekennzeichneten LED-Bausteinen handelt es sich um Frontplatten-Einbauelemente, die als Anzeigeelemente für das 19"-Aufbausystem entwickelt wurden. Das System baut auf einem Grundrastermaß von 2,54 mm auf. Die Gehäuse sind mit seitlichen Stegen und Nuten versehen, die beim Anreihen ineinandergreifen. Bei Bedarf sind Möglichkeiten zur Stapelung gegeben. Zum 19"-Aufbausystem passende Schalter, Schalt- und Prüfbuchsen, Potentiometer sowie Sicherungshalter für G-Sicherungseinsätze finden Sie in unserem THT-Katalog.

The development of these components has benefited from MENTOR's expertise, acquired over decades as a developer and supplier of components for industrial electronics. These components can be used wherever light signals should and must alert functions or operating states. The variety of components ranges from individual and multi-displays and slats in a wide range of designs right up to light sockets.

The LED modules described as FEL are front panel assembly elements that have been developed as display elements for the 19-inch structure system. The system is based on a basic grid size of 2.54 mm. The casings are provided with guide rails and grooves that intersect with each other when connecting. Opportunities for stacking exist if required. Switches, switch sockets, and test sockets, potentiometers, and fuse holders for miniature fuse links can also be found in our THT catalog.

Allgemeine technische Daten (Auswahl bzw. Abweichungen zu den folgenden allgem. Daten: siehe Beschreibung des jeweiligen Artikels)	
Lötbarkeit	DIN EN 60068-2-20 (260 °C ≤ 5s)
Anschlüsse	verzinkt
Betriebstemperatur	-40 °C ... +85 °C
Klima	GPF DIN 40040
Beschriftung	auf Sonderwunsch bedruckt oder gelasert
LEDs	Technische Daten: siehe Seite 78/79
Sonderwünsche	Sonderbestückung, Verwendung von zusätzlichen Fixierpins sowie vertauschte Polarität auf Anfrage möglich.
Mindestbestimmungen für Sonderausführungen auf Anfrage.	

General Technical Data (Selection and deviations from the following general data: see description of the respective item)	
Solderability	DIN EN 60068-2-20 (260 °C ≤ 5s)
Terminals	tinned
Operating temperature	-40 °C ... +85 °C
Climate	GPF DIN 40040
Marking	On special request printed or laser printed
LEDs	Technical data: see page 78/79
Special requirements	Special components, use of additional fixing pins and reverse polarity on request
Minimum quantity for special design on request.	



Einzel-LEDs ø 3 mm liegend

Single LEDs ø 3 mm horizontal

Allgemeine Hinweise und Technische Daten

Allgemeine Hinweise und Technische Daten: siehe Seite 28
Technische Daten LEDs: siehe Seite 78/79

General Remarks and Technical Data

General remarks and technical data: see page 28
Technical data LEDs: see page 78/79

Spezifische Technische Daten

Gehäusewerkstoff: PC schwarz
Kappenwerkstoff: PC UL94 transparent

Specific Technical Data

Housing Material: PC black
Cap material: PC UL94 transparent

Zusätzlich zu dem seitlichen Steg, der seitlichen Nut und einem Fixierzapfen ist dieser Baustein mit einer Klammer ausgerüstet, wodurch der Baustein auf der Leiterplatte gehalten wird und verlötet werden kann. Ein besonderes Merkmal ist die ESD-Festigkeit <15kV nach DIN IEC 801-2.

In addition to the lateral fin and to the lateral groove as well as the fixing pin, this component is equipped with a clamp fastening the component to the printed circuit board and enabling soldering. A special feature is the ESD-solidity <15kV in according to DIN IEC 801-2.

FEL



ESD <15kV

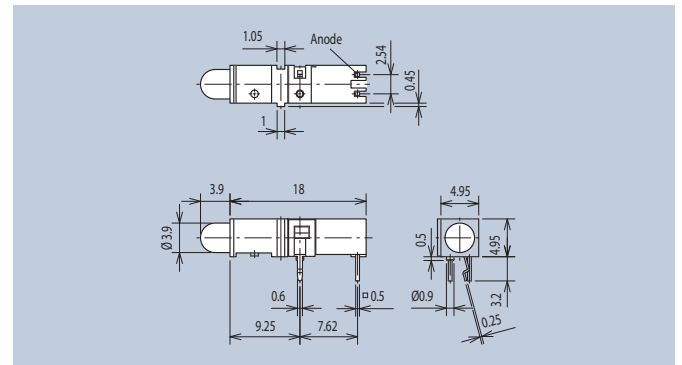

Standard-Ausführung · Standard Version		
Farbe · Color	LED-Type	Art.-Nr.
	bright red	A1 1405.2031
	yellow	A3 1405.7031
	green	A4 1405.8031
Low Current Ausführung · Low Current Version		
Farbe · Color	LED-Type	Art.-Nr.
	high efficiency red	A9 1405.2033
	yellow	A10 1405.7033
	green	A11 1405.8033

Doppel-LEDs ø 3 mm liegend

Double LEDs ø 3 mm horizontal

Spezifische Technische Daten

Gehäusewerkstoff: PC schwarz

Specific Technical Data

Housing Material: PC black

Dieser Baustein ist mit einer ø 3 mm Duo-LED bestückt und ist anreihbar.

This component is equipped with a ø 3 mm Duo LED and can be installed in series.

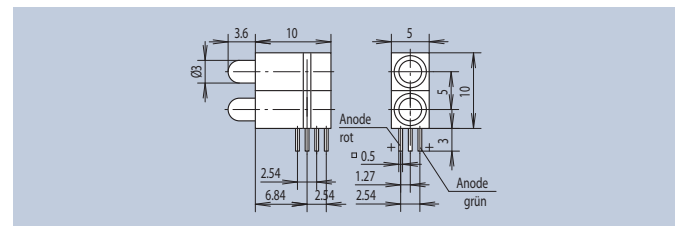
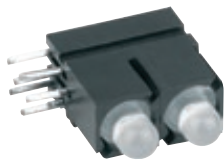

Farbe · Color	LED-Type	Art.-Nr.
	high efficiency red/green	E3 2814.2832

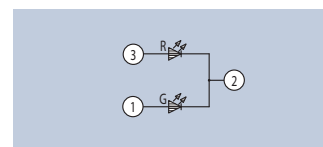

Schaltung · Circuit

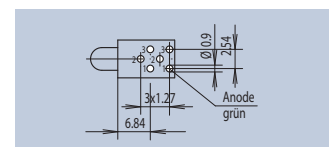

Bohrbild · Drilling Scheme

Dieser Baustein im Anschlussrastermaß von 2,54 mm wird angereicht. Die Anschlüsse sind unbeschnitten.

This component with the connection raster of 2.54 mm can be installed in series. The connections are uncut.

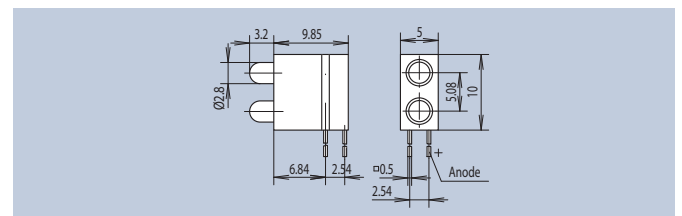

Farbe · Color	LED-Type	Art.-Nr.
	bright red	A1 1900.2
	yellow	A3 1900.4
	green	A4 1900.5

Art.-Nrn. in **Fettdruck** sind Lagerware, Art.-Nrn. in Magerdruck sind keine Lagerware.
Part Nos. in **bold font** are available ex-stock with . Those in normal font are manufactured to order.

Mindestmengen · Minimum quantities
 1.000 auf Anfrage · on request

Technische Daten LEDs

Technical Data LEDs

LED-Type	Emission Color	Wavelength λ (nm) dominant	Lense Color	Forward Voltage V_f (V)		Luminous Intensity I_v (mcd)			at mA	Fwd. Current I_f max (mA)	Rev. Voltage V_R (V)	2 ϕ (50% I_v) deg.
				typ	max	min	typ	max				
THT												
A1	bright red	660	red diffused	2.25	2.5	1.2	-	4	10 20	25	5	60
A2	high efficiency red	625	red diffused	2	2.5	15	-	30	10 20	30	5	60
A3	yellow	588	yellow diffused	2.1	2.5	10	-	20	10 20	30	5	60
A4	green	568	green diffused	2.2	2.5	10	-	20	10 20	25	5	40
A5	bright red	660	red diffused	2.25	2.5	4	-	10	10 20	25	5	60
A6	high efficiency red	625	red diffused	2	2.5	30	-	80	10 20	30	5	60
A7	yellow	588	yellow diffused	2.1	2.5	15	-	30	10 20	30	5	60
A8	green	568	green diffused	2.2	2.5	15	-	30	10 20	25	5	60
A9	high efficiency red	625	red diffused	1.7	2.5	1.2	-	4	2	30	5	60
A10	yellow	588	yellow diffused	1.85	2.5	1.2	-	4	2	30	5	60
A11	green	568	green diffused	1.9	2.5	1	-	5	2	25	5	60
A12	high efficiency red	625	red diffused	2	2.5	4	-	10	2 20	30	5	60
A13	yellow	588	yellow diffused	1.85	2.5	1	-	5	2	30	5	60
A14	green	568	green diffused	2.2	2.5	1	-	5	2 20	25	5	60
A22	bright red	660	red diffused	2.25	2.5	1	-	5	10 20	25	5	70
A23	yellow	588	yellow diffused	2.1	2.5	5	-	17	10 20	30	5	70
A24	green	568	green diffused	2.2	2.5	5	-	17	10 20	25	5	70
A25	bright red	660	red diffused	2.25	2.5	1.2	-	6	10 20	25	5	60
A27	yellow	588	yellow diffused	2.1	2.5	6	-	20	10 20	30	5	60
A28	green	568	green diffused	2.2	2.5	6	-	20	10 20	25	5	60
A29	high efficiency red	625	red diffused	2	2.5	70	-	220	20	30	5	60
A30	yellow	588	yellow diffused	2.1	2.5	36	-	90	20	30	5	60
A31	green	568	green diffused	2.2	2.5	36	-	90	20	25	5	60
A32	high efficiency red	625	red diffused	2	2.5	36	100	-	20	30	5	60
A33	yellow	588	yellow diffused	2.1	2.5	20	-	50	20	30	5	60
A34	green	568	green diffused	2.2	2.5	40	-	60	20	25	5	60
A38	bright red	660	red diffused	2.25	2.5	0.5	-	1.2	10 20	25	5	100
A40	yellow	588	yellow diffused	2.1	2.5	3	-	12	10 20	30	5	100
A41	green	568	green diffused	2.2	2.5	3	-	12	10 20	25	5	100
A42	bright red	660	red diffused	2.25	2.5	1	-	5	10 20	25	5	100
A44	yellow	588	yellow diffused	2.1	2.5	3	-	12	10 20	30	5	100
A45	green	568	green diffused	2.2	2.5	1	-	5	10 20	25	5	100
A46	high efficiency red	625	red diffused	2	2.5	3	-	7	10 20	30	5	110
A47	yellow	588	yellow diffused	2.1	2.5	1.8	-	7	10 20	30	5	110
A48	green	568	green diffused	2.2	2.5	2	-	10	10 20	25	5	110
A49	high efficiency red/green	617 568	white diffused	2 2.2	2.5 2.5	8 8	-	20 40	20 20	30 25	-	60 60
A51	blue	466	blue transparent	3.8	4.5	18	100	-	20	30	5	50
A52	blue	466	blue transparent	3.8	4.5	70	200	-	20	30	5	30
A60	high efficiency red	625	red diffused	5.7	7.5	18	61.56	-	10	60	15	120
A61	yellow	588	yellow diffused	5.85	7.5	7	37.18	-	10	60	15	120
A62	green	568	green diffused	6	7.5	18	53.3	-	10	50	15	120
A69	super red	622-634	red diffused	2	2.5	6.3	-	20	10	40	12	50

Technische Daten LEDs

Technical Data LEDs

LED-Type	Emission Color	Wavelength λ (nm)	Lense Color	Forward Voltage V_f (V)		Luminous Intensity I_v (mcd)			at mA	Fwd. Current I_f max (mA)	Rev. Voltage V_R (V)	2 ϕ (50% I_v) deg.
				typ	max	min	typ	max				
THT												
A70	yellow	580-595	yellow diffused	2	2.5	7.1	-	18	10	40	12	50
A71	green	564-576	green diffused	2	2.5	7.1	-	18	10	40	12	50
A72	super red	622-634	red diffused	2	2.5	7.1	-	18	10	40	12	70
A76	high efficiency red/green	625 568	white diffused	2 2.2	2.5 2.5	5 5	-	20 20	20 20	30 25	-	70 70
A77	super bright red	640	red diffused	1.85	2.5	280	400	-	20	30	5	60
A78	yellow	588	yellow transparent	2.1	2.5	50	-	120	10 20	30	5	30
A79	green	568	green transparent	2.2	2.5	50	-	120	10 20	25	5	30
A83	high efficiency red	625	red transparent	2	2.5	30	-	80	10 20	30	5	50
A84	yellow	588	yellow transparent	2.1	2.5	20	-	50	10 20	30	5	50
A85	green	568	green transparent	2.1	2.5	30	-	50	10 20	25	5	50
C5	orange red/ green	612-625 552-575	white diffused	2 2.4	3 3	1 1	2.5 2.5	-	10 20 10 20	30	6	60
C12	red	630	red diffused	2	3	4	-	32	10 20	20	6	40
C13	yellow	581-594	yellow diffused	2.4	3	2.5	-	12.5	10 20	30	6	40
C14	green	562-575	green diffused	2.4	3	4	-	20	10 20	30	6	40
C15	red	612-625	red diffused	2	3	6.3	-	20	10 20	30	6	60
C16	yellow	581-594	yellow diffused	2.4	3	6.3	-	20	10 20	30	6	60
C17	green	562-575	green diffused	2.4	3	10	-	32	10 20	30	6	60
E3	high efficiency red/green	625 568	white diffused	2 2.2	2.5 2.5	10 10	50 30	-	20 20	30 25	5 5	60 60
G1	bright red	660	red diffused	2.25	2.5	0.4	-	3	20	25	5	40
G2	yellow	588	yellow diffused	2.1	2.5	2.6	10	-	20	30	5	40
G3	super bright green	568	green diffused	2.2	2.5	2.6	10	-	20	25	5	40
H1	super deep red	639	red diffused	2	2.4	40	80	-	20	25	5	100
H2	super yellow	589	yellow diffused	2	2.4	25	50	-	20	25	5	100
H3	super yellow green	573	green diffused	2	2.4	6.3	12.5	-	20	25	5	60
H4	hyper red	624	red diffused	2	2.4	10	20	-	20	25	5	100
M2	white	-	colorless clear	3.6	4	3900	-	11000	20	30	5	20
W1	white	-	colorless clear	3.2	3.8	1400	-	3550	5	25	5	45
Argus												
A15	super red	628	red clear	2.1	2.5	35.5	-	71	15	40	12	

Symbole

Symbols

Besonderheiten · Specifics

 Produktneuheit
New product

 Sehr hoher ESD-Schutz zur Frontplatte bzw. Gehäusefront.
Very high level of ESD protection for the front panel.

 Frontplatten-Einbauelemente zur Nutzung als Anzeigeelemente für das 19"-Aufbausystem.
Front panel assembly elements for use as display elements for the 19-inch structure system.

Kundenspezifisch · Customised

 Kundenspezifische Ausführung möglich. Zu Details siehe Seite 4/6.
Customised solutions available. For details see page 4/6.

 Lagermäßig geführte Artikel (Art.-Nr. in **Fett**druck) liefern wir mit geringen Mindestbestellmengen und kurzen Lieferzeiten.
Parts, that are available ex-stock (Part No. in **bold**) are delivered with small MOQs and short delivery times.

 Mindestbestellmenge für Nicht-Lagerhaltige-Artikel (Art.-Nr. in Magerdruck). Lieferzeit auf Anfrage.
Minimum quantity for manufacture of non-stocked part nos. (in normal font): delivery time on request.

 Mindestbestellmenge für Sonderlängen (Länge A). Lieferzeiten und andere Sonderversionen auf Anfrage.
Minimum quantity for customer defined "Length A": delivery times and other customisation on request.

X-ON Electronics

Largest Supplier of Electrical and Electronic Components

Click to view similar products for [Standard LEDs - SMD category](#):

Click to view products by [Mentor manufacturer](#):

Other Similar products are found below :

[LTST-C19GD2WT](#) [LTST-N683GBEW](#) [LTW-170ZDC](#) [LTW-M140SZS40](#) [598-8110-100F](#) [598-8170-100F](#) [598-8610-202F](#) [67-22VRVGC/TR8](#) [AAAF5060QBFSEEZGS](#) [ALMD-LB36-SV002](#) [APT1608QGW](#) [EASV1803BA0](#) [LG M67K-H1J2-24-0-2-R18-Z](#) [LS A676-P2S1-1](#) [SML-512VWT86A](#) [SML-LX0606SISUGC/A](#) [SML-LXL1307SRC-TR](#) [SML-LXR851SIUPGUBC](#) [LT1ED53A](#) [FAT801-S](#) [AM27ZGC03](#) [APB3025SGNC](#) [APFA3010SURKCGKQBDC](#) [APHK1608VGCA](#) [APT2012QGW](#) [CLX6D-FKB-CN1R1H1BB7D3D3](#) [LTST-008BGEW](#) [LTST-C250KGKT](#) [LTW-010DCG](#) [LTW-020ZDCG](#) [LTW-21TS5](#) [LTW-220DS5](#) [JANTXM19500/521-02](#) [UYGT801-S](#) [42-21UYC/S530-A3/TR8](#) [LO T67F-V1AB-24-1](#) [YGFR411-H](#) [SML-LX0402IC-TR](#) [CMDA20AYAA7D1S](#) [CMDA16AYDR7A1X](#) [339-1SURSYGW/S530-A2](#) [598-8040-100F](#) [598-8070-100F](#) [598-8140-100F](#) [598-8610-200F](#) [EAST2012GA0](#) [SML-LXL1209SYC/ATR](#) [EASV3020YGA0](#) [EAST1608RGBAA0](#) [EAST16086YA5](#)