



# metabo®

PROFESSIONAL POWER TOOL SOLUTIONS

Power Tools + Accessories





	<b>Cordless Tools</b>		<b>13</b>	
	Cordless Class 10.8 Volt	19	Cordless Band Saw	52
	Cordless Class 14.4 Volt / 18 Volt	24	Cordless Circular Saw	52
	Cordless Class 36 Volt	68	Cordless Sabre Saws	21, 53
	Cordless Drills / Screwdrivers	19, 23	Cordless Jigsaws	54
	Cordless Drill	30	Cordless Mitre Saws	55
	Cordless Hammer Drills	20, 31	Cordless Table Saws	56, 70
	Cordless Drywall Screwdrivers	35	Cordless Multi-Tool	57
	Cordless Impact Drivers & Wrenches	20, 36	Cordless Planer	57
	Cordless Hammers	38, 69	Cordless Caulking Guns	21, 58
	Cordless Stirrer	41	Cordless Vacuum Cleaner	59
	Cordless Tapper	41	Cordless Lamps	22, 60
	Cordless Flat-head Angle Grinder	42	Cordless Power Adapters	22, 61
	Cordless Angle Grinders	43, 68	Cordless Worksite Radios	62
	Cordless Band File	48	Cordless Hedge Trimmers	63, 71
	Cordless Fillet Weld Grinder	48	Cordless Blower	63
	Cordless Burnishing Machine	49	Cordless Fan	64
	Cordless Tube Belt Sander	49	Cordless Heated Jacket	64
	Cordless Die Grinders	50	Cordless Combo Sets	65
	Cordless Beveling Tool	51	Battery Packs, Chargers	72
	Cordless Blind Rivet Gun	51		

01

	<b>Angle Grinders, Flat-head Angle Grinders, Angle Polishers</b>		<b>81</b>	
	Flat-head Angle Grinders	82	Wet Polisher	169
	Angle Grinders Ø 100-150 mm	90	Angle Polishers	170
	Angle Grinders Ø 180-230 mm	123		

02

	<b>Processing Stainless Steel</b>		<b>173</b>	
	Inox Angle Grinders	175	Burnishing Machines	185
	Band Files	180	Tube Belt Sanders	192
	Fillet Weld Grinders	183		

03

	<b>Further Metal Processing</b>		<b>197</b>	
	Die Grinders	198	Metal Chop Saw	215
	Beveling Tools	211	Bench Grinders	217

04

	<b>Drilling, Screwdriving, Chiselling, Stirring</b>		<b>223</b>	
	Drills	224	Drywall Screwdrivers	307
	Magnetic Core Drills	232	Screwdrivers	309
	Impact Drills	238	Cordless Impact Drivers & Wrenches	312
	Rotary and Chipping Hammers SDS-plus	275	Stirrers	316
	Rotary and Chipping Hammers SDS-max	286		

05

	<b>Processing of Concrete, Masonry and Plaster</b>		<b>319</b>	
	Cutting Systems	320	Renovation Grinders	326
	Wall Chasers	322	Renovation Milling Machines	330

06

	<b>Sanding, Routing, Planing</b>		<b>333</b>	
	Random Orbital Sanders	334	Routers	365
	Orbital Sanders	338	Router and Grinder Motor	365
	Triangular Base-plate Sander / Multi Sander	341	Paint Remover	370
	Belt Sander	342	Planers	371
	Long-neck Sanders	360		

07

	<b>Sawing</b>		<b>373</b>	
	Circular Saws	374	Sabre Saws	403
	Plunge-cut Saws	376	Multi-Tools	415
	Jigsaws	388		

08

	<b>Semi-stationary Woodworking</b>		<b>419</b>	
	Mitre Saws	420	Site Saws	437
	Crosscut and Table Saw	428	Band Saws	444
	Pull Saws	429	Bench Thicknesser / Planer Thicknesser	450
	Table Saws	432		

09

	<b>Vacuuming and Extraction</b>		<b>453</b>	
	All-purpose Vacuum Cleaners	454	Chip and Dust Extraction Units	468

10

	<b>Other Power Tools</b>		<b>473</b>	
	Hot Air Guns	474	Glue Gun	478
	Staplers	476		

11

	<b>Measuring Technology</b>		<b>479</b>	
	Laser Distance Meters	480	Point and Line Lasers	482

12

	<b>Compressed Air Technology</b>		<b>487</b>	
	Compressors	488	Compressed Air Preparation	525
	Air Tool Sets	499	Compressed Air Distribution	527







13











	<b>Water and Pump Technology</b>		<b>537</b>	
	<b>Drainage</b>		<b>Irrigation / Domestic Water Supply</b>	
	Clear Water Submersible Pumps	540	Garden Pumps	548
	Flat-suction Clear Water Submersible Pumps	541	Domestic Waterworks	551
	Submersible Pressure Pump	543	Automatic Domestic Water Systems	557
	Combi Submersible Pumps	544	Deep Well Pumps	558
	Dirty Water Submersible Pumps	545		
	Construction and Dirty Water Pumps	546		

14

	<b>Hedge Trimmers</b>		<b>569</b>	
---------------------------------------------------------------------------------------	-----------------------	--	------------	--

15

	<b>Accessories for Cordless Tools</b>				
	Battery Packs	72	Further Accessories for Cordless Tools	76	<b>01</b>
	Chargers	73			
	<b>Accessories for Angle Grinders &amp; Polishers</b>				
	Accessories for Flat-head Angle Grinders	87	Semi-flexible Hook and Loop Sanding Sheets	149	<b>02</b>
	Cutting Discs	130	Cleaning Fleece	149	
	Grinding Discs	140	Fibre Sanding Discs	149	
	Cup Wheels	142	Steel-wire Brushes	151	
	Flap Discs	144	Diamond Cutting Discs	153	
	Fleece Compact Polishing Discs	147	Diamond Cup Wheels	158	
	Fleece Compact Grinding Discs	147	Diamond Drill Bits	159	
	Flap Wheels	148	Further Accessories for Angle Grinders	160	
	Hook and Loop Sanding Sheets	148	Accessories for Angle Polishers	171	
	<b>Accessories for Processing Stainless Steel</b>				
	Accessories for Inox Angle Grinders	177	Accessories for Burnishing Machines	186	
	Accessories for Band Files	181	Accessories for Tube Belt Sanders	194	
	Accessories for Fillet Weld Grinders	183			
	<b>Accessories for Further Metal Processing</b>				<b>04</b>
	Rotary Burrs	203	Additional Accessories for Die Grinders	210	
	Corundum Mounted Points	207	Accessories for Beveling Tools	214	
	Flap Wheels	208	Accessories for Curve Shears / Nibblers	214	
	Small Grinding Discs	208	Cutting Discs for Metal Chop Saws	216	
	Small Cutting Discs	209	Accessories for Bench Grinders	220	
	Flexible Shafts	209			
	<b>Accessories for Drilling, Screwdriving, Chiselling, Stirring</b>				<b>05</b>
	Chucks	245	SDS-max Drill Bits	296	
	Metal Drill Bits	252	Dust extraction Drill Bits	298	
	Masonry Drill Bits / Concrete Drill Bits	260	SDS-plus Chisels	300	
	Universal Drill Bits / Glass Drill Bits	263	SDS-max Chisels	302	
	Diamond Drill Bits	263	Concrete Core Cutters	303	
	Wood Drill Bits	264	Core Bits	303	
	Hole Saws	268	Further Accessories for Rotary and Chipping Hammers	304	
	Further Accessories for Drills and Impact Drills	271	Accessories for Screwdrivers	310	
	Accessories for Magnetic Core Drills	235		315	
	SDS-plus Drill Bits	289	Accessories for Stirrers	318	
	<b>Accessories for Processing of Concrete, Masonry and Plaster</b>				<b>06</b>
	Accessories for Wall Chasers and Cutting Systems	324	Accessories for Renovation Milling Machines	332	
	Accessories for Renovation Grinders	331			
	<b>Accessories for Sanding, Routing, Planing</b>				<b>07</b>
	Accessories for Random Orbital Sanders	344	Accessories for Long-neck Sanders	362	
	Accessories for Sanders	351	Accessories for Routers / Router and Grinder Motor	367	
	Accessories for Multi Sanders	354	Accessories for the Paint Remover	372	
	Accessories for Triangular Base-plate Sanders	355	Planer Accessory	372	
	Accessories for Belt Sanders	359			
	Extraction Accessories for Sanding/Grinding Machines	357			

	<b>Accessories for Saws</b>				<b>08</b>
	Circular Saw Blades	378	Other Accessories for Jigsaws	401	
	Guide Rails	386	Sabre Saw Blades	406	
	Jigsaw Blades	391	Accessories for Multi-Tools	416	
	<b>Accessories for Semi-stationary Woodworking</b>				<b>09</b>
	Circular Saw Blades	378	Band Saw Blades	447	
	Additional Accessories for Semi-stationary Circular Saws	439	Further Accessories for Band Saws	449	
			Accessories for Planing Machines	452	
	<b>Accessories for Vacuuming and Extraction</b>				<b>10</b>
	Accessories for All-purpose Vacuum Cleaners	460	Accessories for Chip and Dust Extraction Units	470	
	<b>Accessories for Other Power Tools</b>				<b>11</b>
	Accessories for Hot Air Guns	475	Accessories for Glue Guns	478	
	Accessories for Staplers	477			
	<b>Accessories for Measuring Technology</b>			<b>485</b>	<b>12</b>
	<b>Accessories for Compressed Air Systems</b>				<b>13</b>
	Accessories for Compressed Air Tools	524	Compressed Air Preparation	525	
	Accessories for Compressors	524	Compressed Air Distribution	527	
	<b>Accessories for Water and Pump Technology</b>			<b>559</b>	<b>14</b>
	<b>Accessories for Hedge Trimmers and Chain Saws</b>			<b>575</b>	<b>15</b>
	<b>Case Systems, Bags, Occupational Safety</b>			<b>576</b>	
	<b>Accessory Sets</b>			<b>581</b>	
	<b>Accessory Modules</b>			<b>592</b>	
	<b>Order Number Index</b>			<b>597</b>	

# Productivity by Metabo

## Four good arguments:

With Metabo you always make a good decision. Since productivity is the sum of mobility, safety, robustness and service, it plays a central role for us - just as it does for you, your employees and the efficiency of your company. In a nutshell: With Metabo you are always on the safe side.

### Unlimited mobility

No matter what job you have to do right now, free yourself from cable. With the battery pack technology from Metabo you will achieve performance levels that are in no way inferior to mains-powered tools.



### Maximum safety

The less time lost due to work related illness, the higher your productivity. Our products offer utmost safety and protection for the user's health.



### Comprehensive Service

From application analysis to individual product and system solutions, fast spare parts and repair service: Your workflow is our commitment.



### Durable Robustness

Metabo's machines and accessories provide the best quality, maximum reliability and unparalleled service life. This permits uncompromising high performance even under harshest conditions.

# Made in Germany:

## Innovation is our tradition.

In every Metabo tool there is traditional German engineering ingenuity. Since 1924 we have been developing innovative ideas in our Nürtingen plant and have been implementing them into pioneering tools and perfect accessories for professional users directly on site. Our service, tailor-made to your requirements, also makes us a strong partner for the industrial sector.



Aluminium foundry

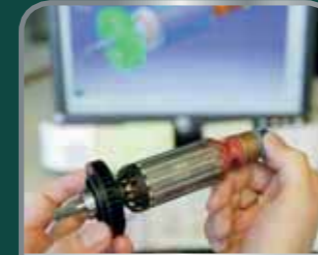

Engineering



Plastic injection moulding



Mould construction



Mechanical production



Assembly



Steel parts with hardening plant



Motor production



# LiHD – The next generation.

Thanks to new LiHD technology, Metabo is the only manufacturer in the world to cover the entire power range – from 400 to 3,200 Watt – from standard tools to unique system solutions. Applications previously reserved for only the most powerful mains powered machines can now be handled cordlessly. It is the combination of many different components that offer added power, service life, and runtime.  
The new LiHD battery packs are now available with 4.0 Ah, 5.5 Ah and 8.0 Ah.

## Powerful

The combination of new high-performance battery cells and completely re-developed components within the LiHD battery pack ensures maximum power availability over an extremely long run time.

### 8.0 Ah

Maximum performance and maximum runtime



### 5.5 Ah

Maximum performance



### 4.0 Ah

Compact and strong



## Leading technology.

### More runtime

- More active material in the cell
- Use of high quality materials (silver and copper)

### More power

with new LiHD cell technology in combination with a newly developed battery pack

- Enlarged power rails and contacts capable of handling high currents
- 3x better conductivity with cell connectors made of a specialized copper alloy



### Longer service life

and extreme ruggedness:

- Optimal protection against internal contamination with fully encapsulated cast design and full protective coating of electronics, as well as optimal gasket in the cover structure.
- Protection of the cells with rubber pads
- Less frequent charging due to more usable cell energy
- Exterior rubber coating on the battery pack provides a secure and non-slip grip and also serves as shock protection



### 100% compatibility

with all Metabo cordless machines, yesterday, today and in the future. In the respective volt class.



### 3-year battery pack warranty

on all Li-Power and LiHD battery packs without a restriction on charging cycles.

## Fast, professional, economical - Metabo's repair service

Metabo tools and accessories stand for highest quality and reliability. However, should damage occur, the Metabo service will take care to provide a fast solution: Minor downtimes with the fast and powerful Metabo repair service. Thanks to our sophisticated repair logistics, we endeavour to ensure that a machine will be repaired and leave our repair service within max. 24 hours. This means that you will be able to continue with your work as soon as possible.

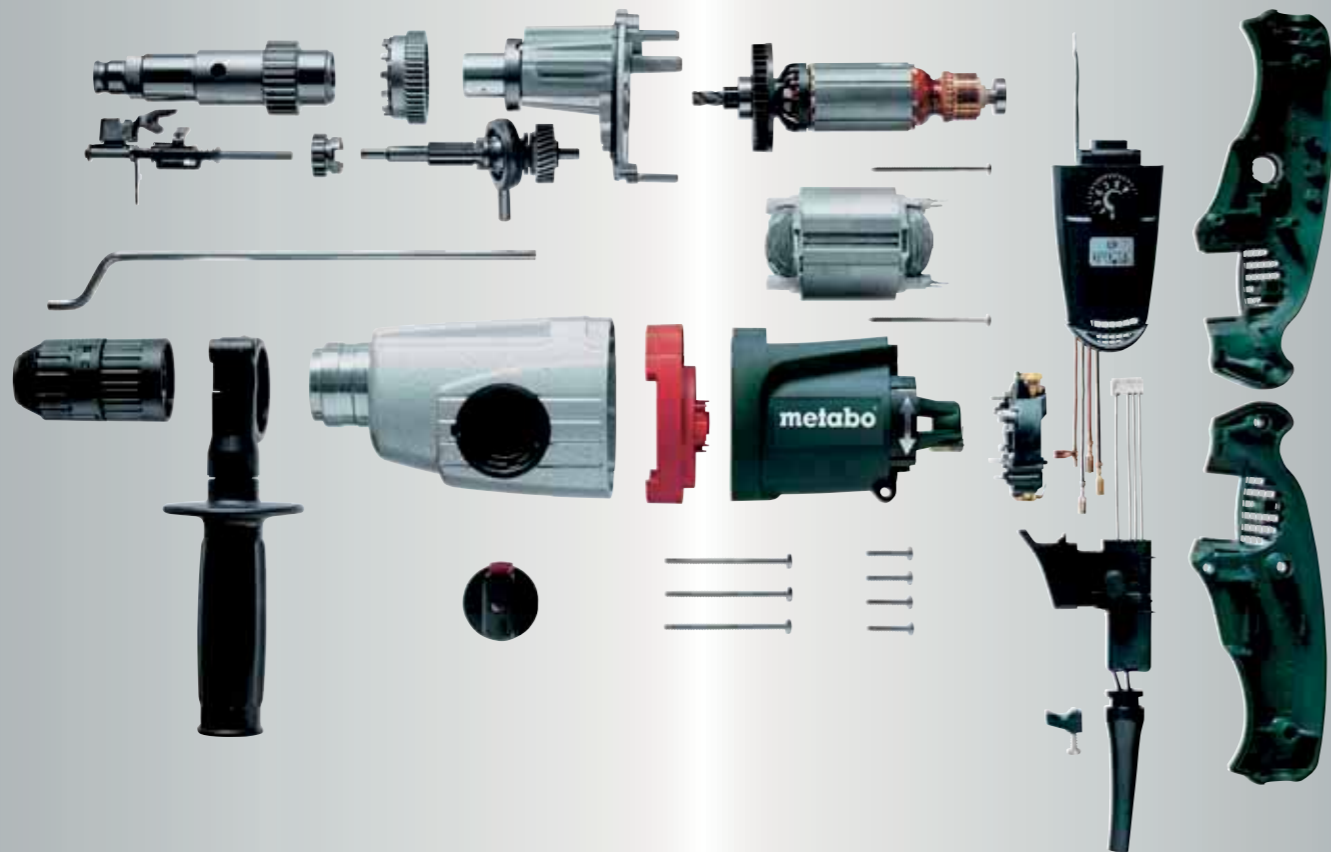

### 3 year XXL warranty

If the worst should come to the worst, Metabo customers are on the safe side thanks to the XXL warranty. Simply register your new Metabo online within 4 weeks from the purchase date and get your warranty extended to 3 years.

### 8 year availability guarantee on spare parts

We also provide safety when it comes to the supply of spare parts: If a Metabo machine is replaced or phased out, we ensure availability of spare parts for 8 more years after production phase out.

### Online service portal [www.metabo-service.com](http://www.metabo-service.com)

At any time, Metabo customers can use our Metabo online service on the Internet at [www.metabo.com](http://www.metabo.com), where they can find all important product information, such as spare parts lists or user manuals.

### Competent product and application advice

If Metabo customers have particular queries about products or applications, our competent and experienced staff in Metabo Service are at their disposal to provide personal support for our customers individual requirements.



## M+ System: Machine and accessories perfectly synchronised for maximum performance.

Even during the development phase at Metabo, machines and accessories are optimally adjusted and tested to complement one another. Your added benefit: Maximum performance for screwdriving, drilling, grinding, cutting and sawing thanks to Metabo + System effect.

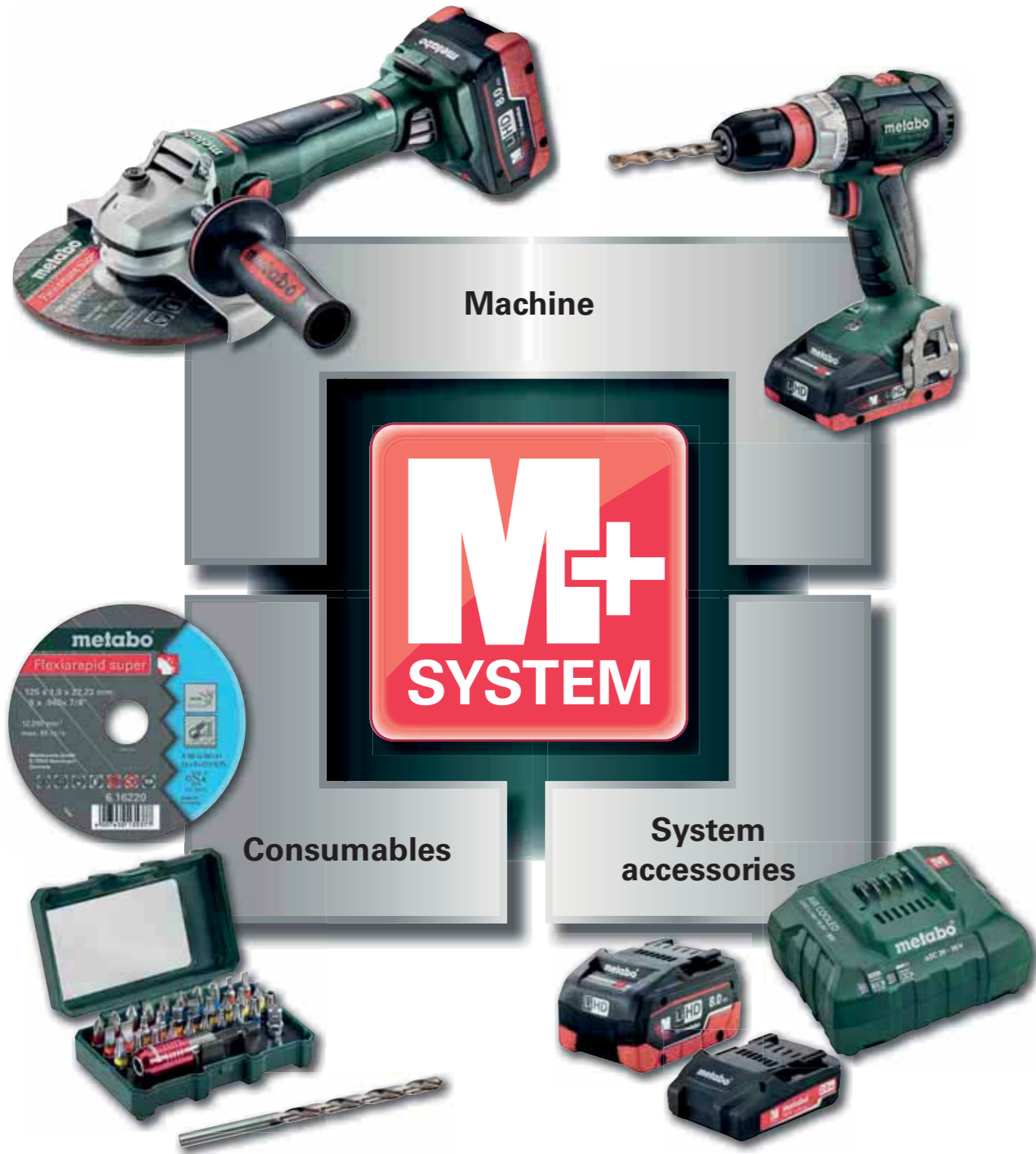

## Cordless Tools

100% compatible. Naturally.

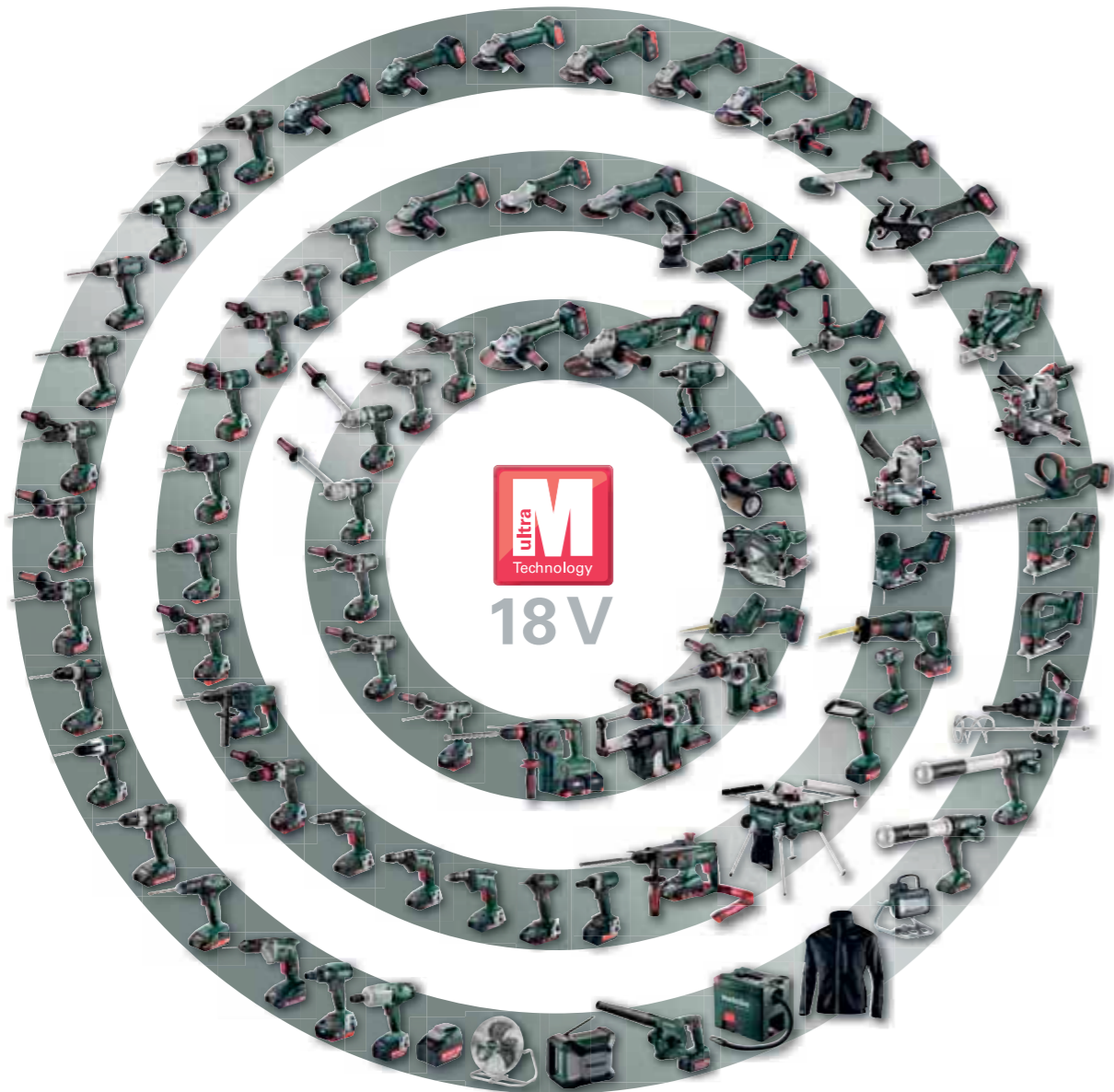

LiHD: Cut the cord – keep the power

A milestone in battery pack technology.

The combination of **new high-performance battery cells** and **completely re-developed components** within the new LiHD battery pack ensures maximum power availability over an extremely long run time.

- **More power** - permits completely new applications with cordless tools
- **Longer runtime** - for even more endurance
- **Longer service life and extreme robustness** - makes your investment even safer
- **Makes applications possible under most demanding conditions**, which had previously only been possible using powerful mains-powered machines
- **New definition of independence**: a milestone along the path towards a cordless construction site



**NEW**  
LiHD 8.0 Ah  
LiHD 5.5 Ah  
LiHD 4.0 Ah



Increased performance thanks to perfect interfaces: the Metabo Ultra-M technology

The Metabo Ultra-M Technology stands for perfect communication at the interface of machine, battery pack and charger. Your benefits: efficient and gentle charging, optimum energy utilisation and extremely long service life.

- Intelligent battery management - for maximum performance and service life
- Permanent Electronic Single Cell Protection (ESCP) when charging, for extremely long service life.
- Patented »AIR COOLED« charging technology for faster charging and longer service life
- Investment in a sustainable battery pack system

**PICK+MIX**

Simply a clever combination

Select only what you need and save money!

Information on pick+mix can be found at [metabo.com](http://metabo.com)



100% compatibility

with all Metabo cordless tools, yesterday, today and in the future. In the respective volt class.



3-year battery pack warranty

on all Li-Power and LiHD battery packs without a restriction on charging cycles.

01  
02  
03  
04  
05  
06  
07  
08  
09  
10  
11  
12  
13  
14  
15



## The right cordless tool for every application.

Metabo offers you a product range of cordless drill/drivers and cordless hammer drills that are ideally adapted to every application, from the smallest to the largest drill diameter or from the smallest to the largest screw, and no matter for which material: At Metabo you will always find the optimum tool for your application.

### Which cordless drills/screwdrivers and hammer drills for which drilling application?



Cordless Drill/ Screwdriver and Cordless Hammer Drill	Power Maxx BS Power Maxx BS Quick Power Maxx SB BS 18 BS 18 Quick SB 18	BS 18 L BS 18 L Quick SB 18 L	BS 18 LT BS 18 LT Quick SB 18 LT BS 18 LT BL BS 18 LT BL Q SB 18 LT BL	BS 18 LTX Quick SB 18 LTX Quick BS 18 LTX Impuls SB 18 LTX Impuls	BS 18 LTX BL Q I SB 18 LTX BL Q I BS 18 LTX BL I SB 18 LTX BL I BS 18 LTX-3 BL Q I SB 18 LTX-3 BL Q I BS 18 LTX-3 BL I SB 18 LTX-3 BL I	SBE 18 LTX
-------------------------------------------------------------	----------------------------------------------------------------------------------------	-------------------------------------	---------------------------------------------------------------------------------------	----------------------------------------------------------------------------	--------------------------------------------------------------------------------------------------------------------------------------------------------------	------------

Wood-Ø in mm						
<b>Twist drill</b>						
to Ø 10						
Ø 10						
Ø 20						
Ø 30						
<b>Auger Bits</b>						
to Ø 10						
Ø 10						
Ø 20						
Ø 30						
Ø 40						
Ø 50						
<b>Fostner drill bit/multi-spur machine bit</b>						
to Ø 10						
Ø 10						
Ø 20						
Ø 30						
Ø 40						
Ø 50						
Ø 68						
Ø 80						
Ø 90						
Ø 105						
Ø 130						
<b>Hole Saws</b>						
to Ø 10						
Ø 10						
Ø 20						
Ø 30						
Ø 40						
Ø 50						
Ø 68						
Ø 80						
Ø 90						
Ø 105						
Ø 130						
Ø 140						
Ø 210						
<b>Masonry Ø* in mm</b>						
Ø 5						
Ø 10						
Ø 13						
Ø 16						
Ø 20						

\* only with cordless hammer drills (SB)

### Which cordless drills/screwdrivers and hammer drills for which drilling application?



Cordless Drill/ Screwdriver and Cordless Hammer Drill		Power Maxx BS Power Maxx BS Quick Power Maxx SB BS 18 BS 18 Quick SB 18	BS 18 L BS 18 L Quick SB 18 L	BS 18 LT BS 18 LT Quick SB 18 LT BS 18 LT BL BS 18 LT BL Q SB 18 LT BL	BS 18 LTX Quick SB 18 LTX Quick BS 18 LTX Impuls SB 18 LTX Impuls	BS 18 LTX BL Q I SB 18 LTX BL Q I BS 18 LTX BL I SB 18 LTX BL I BS 18 LTX-3 BL Q I SB 18 LTX-3 BL Q I BS 18 LTX-3 BL I SB 18 LTX-3 BL I
Full-threaded screws					+ PowerX3	+ PowerX3
mm	Length in mm					
Ø 3	to 35					
Ø 3.5	to 40					
Ø 4.5	to 60					
Ø 5	60					
	80					
	100					
	120					
	140					
Ø 6	160					
	180					
	200					
	240					
	280					
Ø 8	300					
	350					
	400					
	450					
	500					
Ø 10	550					
	600					
	140					
	180					
	200					
Ø 12	220					
	240					
	260					
	280					
	300					
Ø 13	350					
	400					
	450					
	500					
	550					

■ optimum application  
 ■ possible application  
 Intermediate sizes of drill bits or screws are not listed.

# The Metabo Quick system: Versatile and convenient.

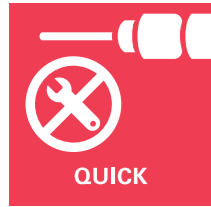

### Quick and efficient working

Quick change of bit retainer and accessory for flexible working

### Increase in efficiency with competence accessories

Thanks to the magnetised female hexagon socket, hex bits or screwdriver bits can be inserted directly into the machine spindle. This assists drilling and screwdriving use in confined spaces and direct torque transmission.

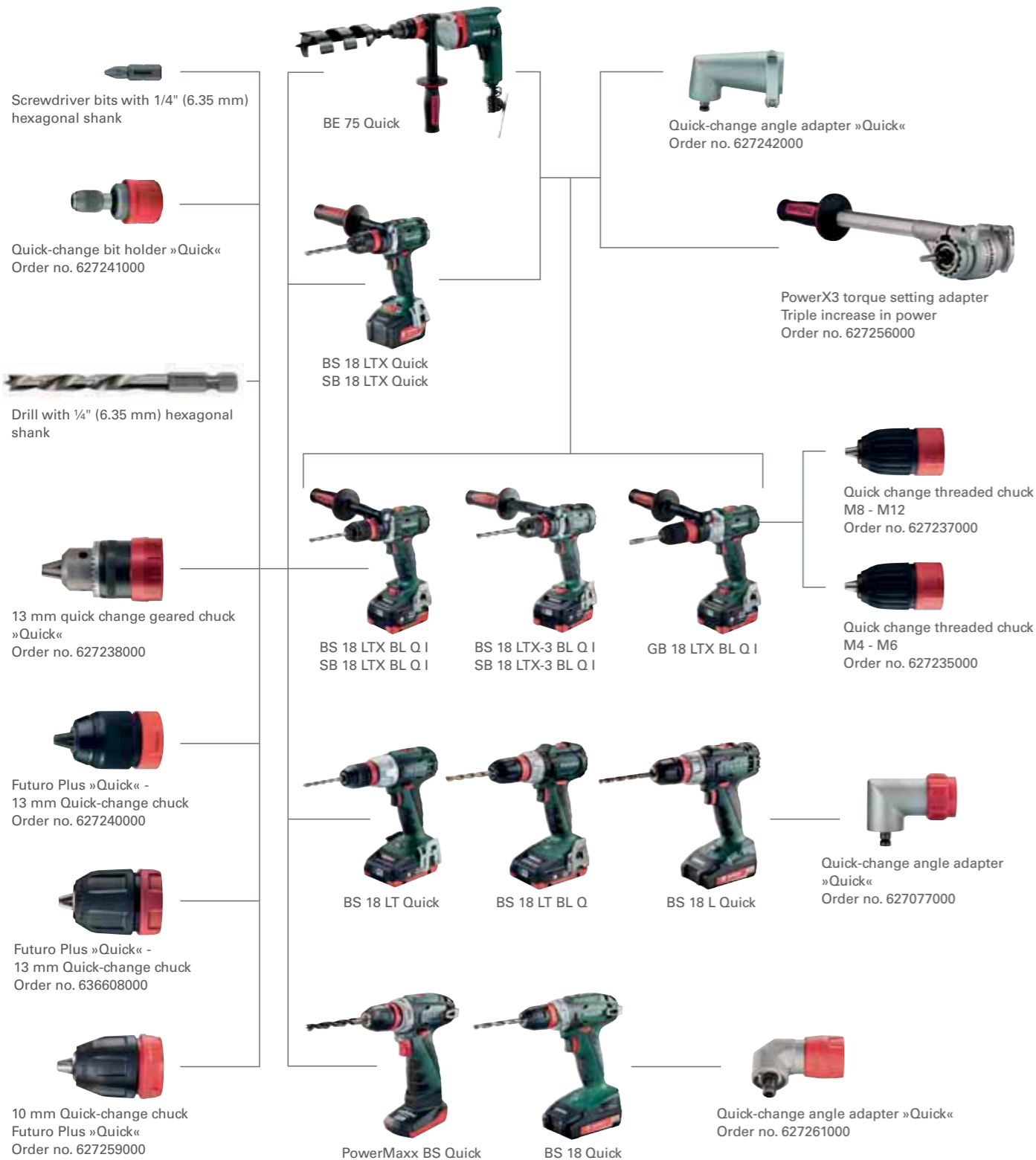

# 10.8 V



### Technical data

	Cordless Drill / Screwdriver PowerMaxx BS Basic	Cordless Drill / Screwdriver PowerMaxx BS Quick Pro
Type of battery pack	Li-Ion	Li-Ion
Battery pack voltage	10.8 V	10.8 V
Maximum torque - soft	17 Nm	17 Nm
Maximum torque, hard	34 Nm	34 Nm
Adjustable torque	0.5 - 5 Nm	0.5 - 5 Nm
Drill Ø steel	10 mm	10 mm
Drill-Ø soft wood	18 mm	18 mm
No-load speeds	0 - 360 / 0 - 1,400 /min	0 - 360 / 0 - 1,400 /min
Chuck capacity	1 - 10 mm	1 - 10 mm
Weight (including battery pack)	0.8 kg	0.8 kg

### Scope of delivery

Order no.	600079	600080	600156	600157
Keyless chuck	■	■		
Quick-change chuck			■	■
Quick-change angle adapter				■
Belt hook	■	■	■	■
Li-Power battery pack (10.8 V/2.0 Ah)	■			■
2 Li-Power battery packs (10.8 V/2.0 Ah)		■	■	
Li-Power battery pack (10.8 V/4.0Ah)				■
Charger LC 40	■	■	■	■
Tool bag	■			
Plastic carry case		■	■	■

Equipment variants can be found in the Metabo price list and on the internet

### Product advantages

- With quick-change angle adapter for drilling and fixing screws in hard to reach places
- Metabo Quick System: quick change of bit retainer and bits, for flexible working
- Light compact drill/screwdriver with extremely compact design for versatile use
- Spindle with hexagonal recess for screwdriver bits for working without chuck
- Integrated working light to illuminate the contact area
- Handy belt hook can be fixed either on the right or left side without tools
- Practical capacity display for checking the charge status

### System components

Accessories → 76, 252

Battery packs → 72

Quick system → 18

10.8 V



10.8 V



Technical data	Cordless Hammer Drill PowerMaxx SB Basic
Type of battery pack	Li-Ion
Battery pack voltage	10.8 V
Maximum torque - soft	17 Nm
Maximum torque, hard	34 Nm
Adjustable torque	0.5 - 5 Nm
Drill-Ø masonry	10 mm
Drill Ø steel	10 mm
Drill-Ø soft wood	18 mm
No-load speed	0 - 360 / 0 - 1,400 /min
Maximum impact rate	21,000 /min
Chuck capacity	1.5 - 10 mm
Weight (including battery pack)	1.12 kg

**Scope of delivery**

Order no.	600385
Keyless chuck	■
Belt hook	■
2 Li-Power battery packs (10.8 V/2.0 Ah)	■
Charger LC 40	■
Plastic carry case	■

Equipment variants can be found in the Metabo price list and on the internet

**Product advantages**

- Light, compact cordless hammer drill with extremely compact design for versatile use
- Hammer drill function for drilling in masonry
- Integrated working light to illuminate the contact area
- Practical capacity display for checking the charge status
- Handy belt hook, can be fixed either on the right or left side

**System components**

Accessories → 234 | Battery packs → 72

Technical data	Cordless Impact Driver PowerMaxx SSD
Type of battery pack	Li-Ion
Battery pack voltage	10.8 V
Max. no-load speed	0 - 2,300 /min
Maximum impact rate	3,000 /min
Maximum torque	105 Nm
Speed/torque levels	1
Bit retainer	Hexagon recess 1/4" (6.35 mm)
Weight (including battery pack)	1 kg

**Scope of delivery**

Order no.	600093
2 Li-Power battery packs (10.8 V/2.0 Ah)	■
Charger LC 40	■
Plastic carry case	■

Equipment variants can be found in the Metabo price list and on the internet

**Product advantages**

- Compact cordless impact wrench for tough applications
- High torque machine with low kick-back
- Integrated work light for illumination of the work area
- Robust die cast aluminium gear housing for optimum heat dissipation and long service life

**System components**

Accessories → 315 | Battery packs → 72

10.8 V



Technical data	Cordless Sabre Saw PowerMaxx ASE
Type of battery pack	Li-Ion
Battery pack voltage	10.8 V
Strokes in idle	0 - 3,100 /min
Saw blade stroke	13 mm
Weight (including battery pack)	1.2 kg

**Scope of delivery**

Order no.	602264
Jigsaw blade for metal	■
Sabre saw blade for wood and metal	■
2 Li-Power battery packs (10.8 V/2.0 Ah)	■
Charger LC 40	■
Plastic carry case	■

Equipment variants can be found in the Metabo price list and on the internet

**Product advantages**

- Light, extremely handy saw for one or two handed operation
- Especially suitable for working in difficult to reach places
- Variospeed (V) Electronics for working with customised stroke rates for the materials used
- Metabo Quick for changing saw blades without tools
- Extended range of application thanks to unique Quick retainer for sabre saw blades and jigsaw blades
- Depth guide can be adjusted without tools for ideal utilisation of the saw blade and diverse applications such as plunge cuts
- Integrated LED work light for optimum illumination of the cutting line
- Practical capacity display for checking the charge status
- Wide range of uses thanks to the adapted Metabo saw blade range

**System components**

Accessories → 391, 406 | Battery packs → 72

10.8 V



Technical data	Cordless Caulking Gun KPA 10.8
Type of battery pack	Li-Ion
Battery pack voltage	10.8 V
Discharge pressure	4,413 N / 450 kg
Holder size	600 ml
Feed rate in idle	2 - 10 mm/s
Suitable for	Cartridges, foil bags
Weight (including battery pack)	2.7 kg

**Scope of delivery**

Order no.	602117610	602117600
600 ml tube		■
400 ml tube	■	
Push plate for foil bag	■	■
Push plate for cartridges	■	■
Li-Power battery pack (10.8 V/4.0Ah)	■	■
Charger LC 40		■

Equipment variants can be found in the Metabo price list and on the internet

**Product advantages**

- High discharge force for processing of all standard materials for sealing and gluing
- Infinitely variable setting of the discharge speed for precision working
- Easy change between cartridges and film bags
- No dripping thanks to automatic retraction of the gear rack
- All-metal gear for long service life

**System components**

Accessories → 78 | Battery packs → 72

# 10.8 V



Technical data	Cordless Torch PowerMaxx TLA LED	Cordless portable lamp PowerMaxx ULA LED	Cordless Inspection Lamp PowerMaxx SLA LED
Max. luminous flux	210 lm	160 lm	340 lm
Max. duration of illumination per battery pack charge	10.8 V / 2.0 Ah: 7.2 h 10.8 V / 4.0 Ah: 14.4 h 10.8 V / 5.2 Ah: 18.7 h	10.8 V / 2.0 Ah: 9.5 h 10.8 V / 4.0 Ah: 19 h 10.8 V / 5.2 Ah: 24.7 h	10.8 V / 2.0 Ah: 3.8 h 10.8 V / 4.0 Ah: 7.6 h 10.8 V / 5.2 Ah: 9.9 h
Weight (without battery pack)	0.13 kg	0.32 kg	0.42 kg

Scope of delivery	606213	600367	600369
Order no.	606213	600367	600369
without battery pack, without charger	■	■	■

### Product advantages

- Powerful LED torch for uniform, bright illumination of the working area
- Compact and handy for versatile use
- Powerful LED portable lamp for uniform, bright illumination of the working area
- Lamp head can be tilted and locked in 12 positions
- Robust aluminium die-cast housing for use on construction sites
- Swivelling hook for suspending the lamp
- Powerful LED inspection lamp for uniform, bright illumination of the working area
- Lamp head can be turned and swivelled through 180° providing almost infinite positions for the lamp
- Robust aluminium die-cast housing for use on construction sites
- Swivelling hook for suspending the lamp

# 10.8 V



Technical data	Cordless Power Adapter PowerMaxx PA
Order no.	606212
without battery pack, without charger	■

Scope of delivery	606212
Order no.	606212
without battery pack, without charger	■

### Product advantages

- Compact, multi-function adapter, can be used as desktop charger and energy source
- Fast USB connection for charging and operating of USB devices (max. charging current 2 A)
- 12 Volt connection for the Metabo heated jacket
- Practical capacity display for checking the charge status

### System components

Battery packs → 72

## LTX cordless drills / screwdrivers and hammer drills: The new reference in the premium class.

With our compact and lightweight LTX drill/screwdrivers and hammer drills, we offer you solutions for demanding drilling and screwdriving jobs independent from mains power. The extremely powerful LTX machines impress with highest torques even for hardest screwdriving applications. Various intelligent functions such as the selectable impulse mode for precise spot-drilling support you in your work. Our brushless LTX models are available for maximum efficiency and speed across the entire application range.



Metabo quick system for versatile use



Metabo »Impuls« for the simple removal of tight-fitting or damaged screws and pilot drilling of materials such as ceramics.

High-performance impact mechanism for best working results

Three-level all metal gear extends the service life of the machine by an enormous degree.

Die-cast aluminium gear housing increases the service life of the machine. The machine is more robust and dissipates heat faster which in turn reduces potential harm to the machine.



BRUSHLESS MOTOR

Metabo motor competence Innovative, powerful Metabo brushless motor for quick work progress and highest efficiency.

SB 18 LTX BL Q I



**Intelligent brushless motors thanks to Ultra-M technology**  
Optimum energy utilisation by virtue of Metabo Ultra-M technology.



**Precision Stop: Torque control for more precision**  
The torque setting 1-4 ensures that the power as well as the speed is automatically adapted, permitting precise working particularly for small screws.



**Maximum performance for highest requirements**  
Enduring and powerful machines for even the most demanding screwdriving and drilling applications.

14.4 V  
18 V



Technical data	Cordless Drill / Screwdriver BS 14.4	Cordless Drill / Screwdriver BS 18	Cordless Drill / Screwdriver BS 18 Quick
Type of battery pack	Li-Ion	Li-Ion / LiHD	Li-Ion / LiHD
Battery pack voltage	14.4 V	18 V	18 V
Maximum torque - soft	20 Nm	24 Nm	24 Nm
Maximum torque, hard	40 Nm	48 Nm	48 Nm
Adjustable torque	0.5 - 4.5 Nm	0.5 - 4.5 Nm	0.5 - 4.5 Nm
Drill Ø steel	10 mm	10 mm	10 mm
Drill-Ø soft wood	20 mm	20 mm	20 mm
No-load speeds	0 - 400 / 0 - 1,500 /min	0 - 450 / 0 - 1,600 /min	0 - 450 / 0 - 1,600 /min
Chuck capacity	1 - 10 mm	1 - 10 mm	1 - 10 mm
Weight (including battery pack)	1.2 kg	1.3 kg	1.3 kg

**Scope of delivery**

Order no.	602206	602207	602217 <sup>1)</sup>
Keyless chuck	■	■	
Quick-change chuck			■
Belt hook	■	■	■
2 Li-Power battery packs (14.4 V/2.0 Ah)	■		
2 Li-Power battery packs (18 V/2.0 Ah)		■	■
Charger SC 60 Plus	■	■	■
Plastic carry case	■	■	■

Equipment variants can be found in the Metabo price list and on the internet  
<sup>1)</sup> also available in 120 V (North/Latin America)

**Product advantages**

- Metabo Quick System: quick change of bit retainer and bits, for flexible working
- Spindle with hexagonal recess for screwdriver bits for working without chuck
- Light compact drill/screwdriver with extremely compact design for versatile use
- Integrated working light to illuminate the contact area
- Handy belt hook can be fixed either on the right or left side without tools
- Battery packs with capacity display for checking the charge status

**System components**

Accessories → 76, 252 | Battery packs → 72 | Quick system → 18

18 V



Technical data	Cordless Drill / Screwdriver BS 18 L	Cordless Drill / Screwdriver BS 18 L Quick
Type of battery pack	Li-Ion / LiHD	Li-Ion / LiHD
Battery pack voltage	18 V	18 V
Maximum torque - soft	25 Nm	25 Nm
Maximum torque, hard	50 Nm	50 Nm
Adjustable torque	1.5 - 6 Nm	1.5 - 6 Nm
Drill Ø steel	10 mm	10 mm
Drill-Ø soft wood	20 mm	20 mm
No-load speeds	0 - 450 / 0 - 1800 /min	0 - 450 / 0 - 1800 /min
Chuck capacity	1.5 - 13 mm	1.5 - 13 mm
Weight (including battery pack)	1.6 kg	1.6 kg

**Scope of delivery**

Order no.	602321	602320 <sup>1)</sup>
Keyless chuck	■	
Quick-change chuck		■
Belt hook and bit case	■	■
2 Li-Power battery packs (18 V/2.0 Ah)	■	■
Charger SC 60 Plus	■	■
Plastic carry case	■	■

Equipment variants can be found in the Metabo price list and on the internet  
<sup>1)</sup> also available in 120 V (North/Latin America)

**Product advantages**

- Handy belt hook, can be fixed either on the right or left side
- Metabo Quick System: quick change of bit retainer and bits, for flexible working
- Spindle with hexagonal recess for screwdriver bits for working without chuck
- Handy belt hook and bit holder can be fixed either on the right or left side
- Powerful compact drill/screwdriver with compact design
- Integrated LED work light with night light function for optimal brightness in the work area
- Battery packs with capacity display for checking the charge status

**System components**

Accessories → 76, 252 | Battery packs → 72 | Quick system → 18

01  
02  
03  
04  
05  
06  
07  
08  
09  
10  
11  
12  
13  
14  
15

18 V



Technical data	Cordless Drill / Screwdriver BS 18 LT	Cordless Drill / Screwdriver BS 18 LT Quick	Cordless Drill / Screwdriver BS 18 LT BL	Cordless Drill / Screwdriver BS 18 LT BI Q
Type of battery pack	Li-Ion / LiHD	Li-Ion / LiHD	Li-Ion / LiHD	Li-Ion / LiHD
Battery pack voltage	18 V	18 V	18 V	18 V
Maximum torque - soft	34 Nm	34 Nm	34 Nm	34 Nm
Maximum torque, hard	60 Nm	60 Nm	60 Nm	60 Nm
Adjustable torque	0.7 - 8 Nm	0.7 - 8 Nm	0.7 - 8 Nm	0.7 - 8 Nm
Drill Ø steel	13 mm	13 mm	13 mm	13 mm
Drill-Ø soft wood	38 mm	38 mm	38 mm	38 mm
No-load speeds	0 - 450 / 0 - 1,600 /min	0 - 450 / 0 - 1,600 /min	0 - 600 / 0 - 2,100 /min	0 - 600 / 0 - 2,100 /min
Chuck capacity	1.5 - 13 mm	1.5 - 13 mm	1.5 - 13 mm	1.5 - 13 mm
Weight (including battery pack)	1.8 kg	1.9 kg	1.7 kg	1.5 kg

Scope of delivery

Order no.	602102 <sup>1)</sup>	602104	602325 <sup>1)</sup>	602334
Keyless chuck	■		■	
Quick-change chuck		■		■
Quick-change bit holder		■		■
Belt hook and bit case	■	■	■	■
2 LiHD battery packs (18 V/4.0 Ah)	■	■	■	■
Charger ASC 30-36 V »AIR COOLED«	■	■	■	■
Plastic carry case	■	■	■	■

Equipment variants can be found in the Metabo price list and on the internet  
<sup>1)</sup> also available in 120 V (North/Latin America)

Product advantages

- Metabo Quick System: quick change of bit retainer and bits, for flexible working
- Metabo Quick System: quick change of bit retainer and bits, for flexible working
- Powerful Metabo 4-pole motor for fast drilling and screwdriving
- Brushless drill/screwdriver with compact design for universal and demanding applications
- Unique Metabo brushless motor for quick work progress and highest efficiency when drilling and screwdriving
- Integrated working light to illuminate the contact area
- Handy belt hook and bit holder can be fixed either on the right or left side
- Battery packs with capacity display for checking the charge status

System components

- Accessories → 76, 252
- Battery packs → 72
- Quick system → 18

18 V

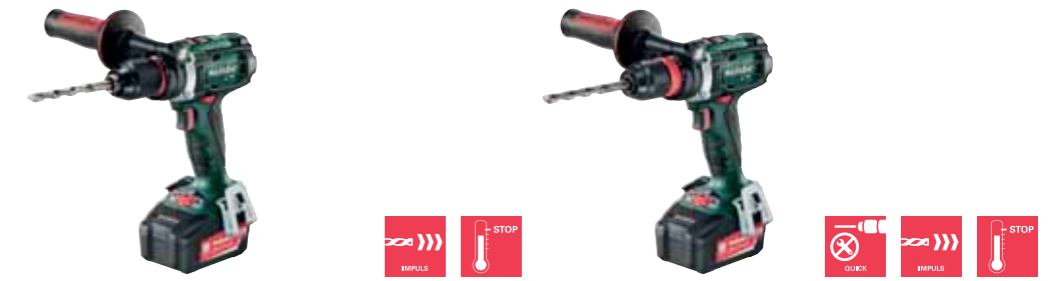

Technical data	Cordless Drill / Screwdriver BS 18 LTX Impuls	Cordless Drill / Screwdriver BS 18 LTX Quick
Type of battery pack	Li-Ion / LiHD	Li-Ion / LiHD
Battery pack voltage	18 V	18 V
Maximum torque - soft	55 Nm	55 Nm
Pulse torque	60 Nm	60 Nm
Maximum torque, hard	110 Nm	110 Nm
Adjustable torque	1.5 - 24 Nm	1.5 - 24 Nm
Drill Ø steel	13 mm	13 mm
Drill-Ø soft wood	65 mm	65 mm
No-load speeds	0 - 500 / 0 - 1,700 /min	0 - 500 / 0 - 1,700 /min
Chuck capacity	1.5 - 13 mm	1.5 - 13 mm
Weight (including battery pack)	2.3 kg	2.3 kg

Scope of delivery

Order no.	602191 <sup>1)</sup>	602193
Futuro Plus keyless chuck with metal sleeve	■	
Quick-change chuck		■
Quick-change bit holder		■
Side handle	■	■
Belt hook and bit case	■	■
2 Li-Power battery packs (18 V/5.2 Ah)	■	■
Charger ASC 30-36 V »AIR COOLED«	■	■
Plastic carry case	■	■

Equipment variants can be found in the Metabo price list and on the internet  
<sup>1)</sup> also available in 120 V (North/Latin America)

Product advantages

- Metabo Quick System: quick change of bit retainer and bits, for flexible working
- Selectable "impuls" mode for removal of stubborn screws and for spot-drilling on smooth surfaces
- Powerful Metabo 4-pole motor for fast drilling and screwdriving
- Overload protection: protects the motor from overheating
- Collar (Ø 43 mm) for versatile use
- Integrated working light to illuminate the contact area
- Robust die cast aluminium gear housing for optimum heat dissipation and long service life
- Handy belt hook and bit holder can be fixed either on the right or left side
- Battery packs with capacity display for checking the charge status

System components

- Accessories → 76, 252
- Battery packs → 72
- Quick system → 18

18 V



Technical data	Cordless Drill / Screwdriver BS 18 LTX BL I	Cordless Drill / Screwdriver BS 18 LTX BL Q I	Cordless Drill / Screwdriver BS 18 LTX BL Q I with PowerX3
Type of battery pack	Li-Ion / LiHD	Li-Ion / LiHD	Li-Ion / LiHD
Battery pack voltage	18 V	18 V	18 V
Maximum torque - soft	60 Nm	60 Nm	60 Nm
Pulse torque	65 Nm	65 Nm	65 Nm
Maximum torque, hard	120 Nm	120 Nm	120 Nm
Adjustable torque	1 - 20 Nm	1 - 20 Nm	1 - 20 Nm
Drill Ø steel	13 mm	13 mm	13 mm
Drill-Ø soft wood	65 mm	65 mm	65 mm
No-load speeds	0 - 500 / 0 - 1,850 /min	0 - 500 / 0 - 1,850 /min	0 - 500 / 0 - 1,850 /min
Chuck capacity	1.5 - 13 mm	1.5 - 13 mm	1.5 - 13 mm
Weight (including battery pack)	2.3 kg	2.5 kg	2.5 kg

Scope of delivery

Order no.	602350 <sup>1)</sup>	602351	602351770
PowerX 3 torque setting adapter with long side handle			■
Futuro Plus keyless chuck with metal sleeve	■		
Quick-change chuck		■	■
Quick-change bit holder		■	■
Side handle	■	■	■
Belt hook and bit case		■	■
2 Li-Power battery packs (18 V/5.2 Ah)	■		
2 LiHD battery packs (18 V/5.5 Ah)		■	■
Charger ASC 30-36 V »AIR COOLED«	■	■	■
Plastic carry case	■	■	■

Equipment variants can be found in the Metabo price list and on the internet  
<sup>1)</sup> also available in 120 V (North/Latin America)

Product advantages

- The torque setting adapter PowerX3 triples the power of the tool for extreme applications
- Metabo Quick System: quick change of bit retainer and bits, for flexible working
- Brushless drill/screwdriver with maximum power for demanding applications
- Selectable "impuls" mode for removal of stubborn screws and for spot-drilling on smooth surfaces
- Unique Metabo brushless motor for quick work progress and highest efficiency when drilling and screwdriving
- Collar (Ø 43 mm) for versatile use
- Integrated working light to illuminate the contact area
- Robust die cast aluminium gear housing for optimum heat dissipation and long service life
- Handy belt hook and bit holder can be fixed either on the right or left side
- Battery packs with capacity display for checking the charge status

System components

Accessories → 76, 252 | Battery packs → 72 | Quick system → 18

18 V



Technical data	Cordless 3-Speed Drill / Screwdriver BS 18 LTX-3 BL I	Cordless 3-Speed Drill / Screwdriver BS 18 LTX-3 BL Q I
Type of battery pack	Li-Ion / LiHD	Li-Ion / LiHD
Battery pack voltage	18 V	18 V
Maximum torque - soft	60 Nm	60 Nm
Pulse torque	65 Nm	65 Nm
Maximum torque, hard	120 Nm	120 Nm
Adjustable torque	1 - 20 Nm	1 - 20 Nm
Drill Ø steel	13 mm	13 mm
Drill-Ø soft wood	65 mm	65 mm
No-load speeds	0 - 500 / 0 - 2,050 / 0 - 3,800 /min	0 - 500 / 0 - 2,050 / 0 - 3,800 /min
Chuck capacity	1.5 - 13 mm	1.5 - 13 mm
Weight (including battery pack)	2.6 kg	2.6 kg

Scope of delivery

Order no.	602354	602355 <sup>1)</sup>
Futuro Plus keyless chuck with metal sleeve	■	
Quick-change chuck		■
Quick-change bit holder		■
Side handle	■	■
Belt hook and bit case	■	■
2 LiHD battery packs (18 V/5.5 Ah)	■	■
Charger ASC 30-36 V »AIR COOLED«	■	■
Plastic carry case	■	■

Equipment variants can be found in the Metabo price list and on the internet  
<sup>1)</sup> also available in 120 V (North/Latin America)

Product advantages

- Metabo Quick System: quick change of bit retainer and bits, for flexible working
- Brushless 3-speed drill/screwdriver with maximum power for demanding applications
- Third speed setting with high torque (max. 3,800/min) for extended range of application and even faster drilling progress
- Selectable "impuls" mode for removal of stubborn screws and for spot-drilling on smooth surfaces
- Unique Metabo brushless motor for quick work progress and highest efficiency when drilling and screwdriving
- Collar (Ø 43 mm) for versatile use
- Integrated working light to illuminate the contact area
- Robust die cast aluminium gear housing for optimum heat dissipation and long service life
- Handy belt hook and bit holder can be fixed either on the right or left side
- Battery packs with capacity display for checking the charge status

System components

Accessories → 76, 252 | Battery packs → 72 | Quick system → 18

18 V



Technical data	Cordless Drill BE 18 LTX 6
Type of battery pack	Li-Ion / LiHD
Battery pack voltage	18 V
Maximum torque	4 Nm
Drill Ø steel	6 mm
Drill-Ø soft wood	12 mm
No-load speeds	0 - 4,000 /min
Chuck capacity	1 - 10 mm
Weight (including battery pack)	1.2 kg

Scope of delivery	
Order no.	600261
Futuro Plus keyless chuck with metal sleeve	■
Open-jawed spanner	■
MetaLoc case	■
without battery pack, without charger	■

- Product advantages**
- Fast and handy cordless drill with high precision for drilling into metal
  - Collar (Ø 43 mm) for versatile use
  - Integrated working light to illuminate the contact area
  - Robust die cast aluminium gear housing for optimum heat dissipation and long service life
  - Overload protection: protects the motor from overheating

**System components**

Accessories → 252 | Battery packs → 72

18 V



Technical data	Cordless Hammer Drill SB 18	Cordless Hammer Drill SB 18 L	Cordless Hammer Drill SB 18 LT	Cordless Hammer Drill SB 18 LT BL
Type of battery pack	Li-Ion / LiHD	Li-Ion / LiHD	Li-Ion / LiHD	Li-Ion / LiHD
Battery pack voltage	18 V	18 V	18 V	18 V
Maximum torque - soft	24 Nm	25 Nm	34 Nm	34 Nm
Maximum torque, hard	48 Nm	50 Nm	60 Nm	60 Nm
Adjustable torque	0.5 - 4.5 Nm	1.5 - 6 Nm	0.7 - 8 Nm	0.7 - 8 Nm
Drill-Ø masonry	10 mm	10 mm	13 mm	13 mm
Drill Ø steel	10 mm	10 mm	13 mm	13 mm
Drill-Ø soft wood	20 mm	20 mm	38 mm	38 mm
No-load speed	0 - 450 / 0 - 1,600 /min	0 - 450 / 0 - 1800 /min	0 - 450 / 0 - 1,600 /min	0 - 600 / 0 - 2,100 /min
Maximum impact rate	24,000 /min	27,000 /min	27,200 /min	31,950 /min
Chuck capacity	1 - 10 mm	1.5 - 13 mm	1.5 - 13 mm	1.5 - 13 mm
Weight (including battery pack)	1.41 kg	1.6 kg	1.9 kg	1.8 kg

Scope of delivery				
Order no.	602245	602317 <sup>1)</sup>	602103 <sup>1)</sup>	602316 <sup>1)</sup>
Keyless chuck	■	■	■	■
Belt hook and bit case	■	■	■	■
2 Li-Power battery packs (18 V/2.0 Ah)	■	■		
2 LiHD battery packs (18 V/4.0 Ah)			■	■
Charger ASC 30-36 V »AIR COOLED«			■	■
Charger SC 60 Plus	■	■		
Plastic carry case	■	■	■	■

Equipment variants can be found in the Metabo price list and on the internet  
<sup>1)</sup> also available in 120 V (North/Latin America)

- Product advantages**
- Light, compact cordless hammer drill with extremely compact design for versatile use
  - Powerful, compact hammer drill with extremely compact design
  - Powerful Metabo 4-pole motor for fast drilling and screwdriving
  - Unique Metabo brushless motor for quick work progress and highest efficiency when drilling and screwdriving
  - Hammer drill function for drilling in masonry
  - High-performance impact mechanism for optimum drilling performance
  - Spindle with hexagonal recess for screwdriver bits for working without chuck
  - Integrated working light to illuminate the contact area
  - With handy belt hook and bit case which can be fixed either on the right or left side
  - Battery packs with capacity display for checking the charge status

**System components**

Accessories → 252 | Battery packs → 72



18 V



Technical data	Cordless Hammer Drill SB 18 LTX Impuls	Cordless Hammer Drill SB 18 LTX Quick
Type of battery pack	Li-Ion / LiHD	Li-Ion / LiHD
Battery pack voltage	18 V	18 V
Maximum torque - soft	55 Nm	55 Nm
Pulse torque	60 Nm	60 Nm
Maximum torque, hard	110 Nm	110 Nm
Adjustable torque	1.5 - 24 Nm	1.5 - 24 Nm
Drill-Ø masonry	16 mm	16 mm
Drill Ø steel	13 mm	13 mm
Drill-Ø soft wood	65 mm	65 mm
No-load speed	0 - 500 / 0 - 1,700 /min	0 - 500 / 0 - 1,700 /min
Maximum impact rate	32,300 /min	32,300 /min
Chuck capacity	1.5 - 13 mm	1.5 - 13 mm
Weight (including battery pack)	2.4 kg	2.4 kg

Scope of delivery

Order no.	602192 <sup>1)</sup>	602200
Quick-change chuck		■
Futuro Plus keyless chuck with metal sleeve	■	
Quick-change bit holder		■
Side handle	■	■
Belt hook and bit case	■	■
2 Li-Power battery packs (18 V/5.2 Ah)	■	■
Charger ASC 30-36 V »AIR COOLED«	■	■
Plastic carry case	■	■

Equipment variants can be found in the Metabo price list and on the internet  
<sup>1)</sup> also available in 120 V (North/Latin America)

Product advantages

- Metabo Quick System: quick change of bit retainer and bits, for flexible working

- Selectable "impuls" mode for removal of stubborn screws and for spot-drilling on smooth surfaces
- Powerful Metabo 4-pole motor for fast drilling and screwdriving
- High-performance impact mechanism for optimum drilling performance
- Collar (Ø 43 mm) for versatile use
- Integrated working light to illuminate the contact area
- Robust die cast aluminium gear housing for optimum heat dissipation and long service life
- With handy belt hook and bit case which can be fixed either on the right or left side
- Battery packs with capacity display for checking the charge status

System components

Accessories → 76, 252 | Battery packs → 72 | Quick system → 18

18 V



Technical data	Cordless Hammer Drill SB 18 LTX BL I	Cordless Hammer Drill SB 18 LTX BL Q I	Cordless 3-Speed Hammer Drill SB 18 LTX-3 BL I	Cordless 3-Speed Hammer Drill SB 18 LTX-3 BL Q I
Type of battery pack	Li-Ion / LiHD	Li-Ion / LiHD	Li-Ion / LiHD	Li-Ion / LiHD
Battery pack voltage	18 V	18 V	18 V	18 V
Maximum torque - soft	60 Nm	60 Nm	60 Nm	60 Nm
Pulse torque	65 Nm	60 Nm	65 Nm	65 Nm
Maximum torque, hard	120 Nm	120 Nm	120 Nm	120 Nm
Adjustable torque	1 - 20 Nm	1 - 20 Nm	1 - 20 Nm	1 - 20 Nm
Drill-Ø masonry	16 mm	16 mm	16 mm	16 mm
Drill Ø steel	13 mm	13 mm	13 mm	13 mm
Drill-Ø soft wood	65 mm	65 mm	65 mm	65 mm
No-load speed	0 - 500 / 0 - 1,850 /min	0 - 500 / 0 - 1,850 /min	0 - 500 / 0 - 2,050 / 0 - 3,800 /min	0 - 500 / 0 - 2,050 / 0 - 3,800 /min
Maximum impact rate	32,300 /min	32,300 /min	32,300 /min	32,300 /min
Chuck capacity	1.5 - 13 mm	1.5 - 13 mm	1.5 - 13 mm	1.5 - 13 mm
Weight (including battery pack)	2.4 kg	2.7 kg	2.8 kg	2.8 kg

Scope of delivery

Order no.	602352 <sup>1)</sup>	602353	602356	602357 <sup>1)</sup>
Quick-change chuck		■		■
Futuro Plus keyless chuck with metal sleeve	■		■	
Quick-change bit holder		■		■
Side handle	■	■	■	■
Belt hook and bit case	■	■	■	■
2 Li-Power battery packs (18 V/5.2 Ah)	■	■	■	■
2 LiHD battery packs (18 V/5.5 Ah)		■	■	■
Charger ASC 30-36 V »AIR COOLED«	■	■	■	■
Plastic carry case	■	■	■	■

Equipment variants can be found in the Metabo price list and on the internet  
<sup>1)</sup> also available in 120 V (North/Latin America)

Product advantages

- Metabo Quick System: quick change of bit retainer and bits, for flexible working
- Metabo Quick System: quick change of bit retainer and bits, for flexible working

- Third speed setting with high torque (max. 3,800/min) for extended range of application and even faster drilling progress

- Brushless hammer drill with maximum power for demanding applications
- Selectable "impuls" mode for removal of stubborn screws and for spot-drilling on smooth surfaces
- Unique Metabo brushless motor for quick work progress and highest efficiency when drilling and screwdriving
- Collar (Ø 43 mm) for versatile use
- Integrated working light to illuminate the contact area
- Robust die cast aluminium gear housing for optimum heat dissipation and long service life
- Battery packs with capacity display for checking the charge status

System components

Accessories → 76, 252 | Battery packs → 72 | Quick system → 18

18 V



Technical data	Cordless Hammer Drill SBE 18 LTX
Type of battery pack	Li-Ion / LiHD
Battery pack voltage	18 V
Maximum torque - soft	24 Nm
Drill-Ø masonry	18 mm
Drill Ø steel	13 mm
Drill-Ø soft wood	30 mm
No-load speed	0 - 1,000 / 0 - 3,000 /min
Maximum impact rate	57,000 /min
Chuck capacity	1.5 - 13 mm
Weight (including battery pack)	2.6 kg

**Scope of delivery**

Order no.	600845
Futuro Plus keyless chuck	■
Side handle	■
Drilling depth guide	■
2 Li-Power battery packs (18 V/2.0 Ah)	■
Charger ASC 30-36 V »AIR COOLED«	■
Plastic carry case	■

Equipment variants can be found in the Metabo price list and on the internet

**Product advantages**

- High-performance cordless hammer drill for powerful drilling in masonry equivalent to that of a mains-powered tool
- Metabo S-automatic safety clutch: mechanical decoupling of the drive for safe working should the tool stop unexpectedly
- Spindle with hexagonal recess for screwdriver bits for working without chuck
- Collar (Ø 43 mm) for versatile use
- Integrated working light to illuminate the contact area
- Practical capacity display for checking the charge status

**System components**

Accessories → 252 | Battery packs → 72

18 V



Technical data	Cordless Drywall Screwdriver SE 18 LTX 2500	Cordless Drywall Screwdriver SE 18 LTX 4000	Cordless Drywall Screwdriver SE 18 LTX 6000
Type of battery pack	Li-Ion / LiHD	Li-Ion / LiHD	Li-Ion / LiHD
Battery pack voltage	18 V	18 V	18 V
Bit retainer	Hexagon recess 1/4" (6.35 mm)	Hexagon recess 1/4" (6.35 mm)	Hexagon recess 1/4" (6.35 mm)
Maximum torque - soft	9 Nm	7 Nm	5 Nm
No-load speed	0 - 2,500 /min	0 - 4,000 /min	0 - 6,000 /min
Weight (including battery pack)	1.4 kg	1.3 kg	1.3 kg

**Scope of delivery**

Order no.	620047	620048	620049
Depth guide	■	■	■
Magnetic bit holder 1/4" (6.35 mm)	■	■	■
Phillips screwdriver bit, size 2/25 mm	■	■	■
Belt hook	■	■	■
2 Li-Power battery packs (18 V/2.0 Ah)	■	■	■
Charger ASC 30-36 V »AIR COOLED«	■	■	■
Plastic carry case	■	■	■

Equipment variants can be found in the Metabo price list and on the internet

**Product advantages**

- Drywall screwdriver with high torque for fixing of gypsum plasterboards and gypsum fibre boards to wood and metal framework
- Drywall screwdriver for fixing gypsum plasterboards to wood and metal; also suitable for gypsum fibre boards to metal frames
- The specialist for gypsum plasterboards in drywall construction situations: high torque for even faster productivity
- Compact and light design for comfortable one-hand operation
- Precise driving of screws by virtue of finely adjustable depth guide and low-noise claw clutch
- Depth guide can be fully removed for inspection during operation
- Variospeed (V) Electronics for working at customised speeds to suit various application materials
- Integrated working light to illuminate the contact area
- Handy belt hook, can be fixed either on the right or left side
- Battery packs with capacity display for checking the charge status

**System components**

Accessories → 310 | Battery packs → 72

01

02

03

04

05

06

07

08

09

10

11

12

13

14

15

# Cordless impact drivers & wrenches: Compact tools, great performance.

As compact as the smallest, as powerful as the largest: With the SSW 18 LTX 400 BL cordless impact wrench we are offering you a unique performance class of cordless impact wrenches. The tool not only covers the complete performance range of medium-sized impact drills with its excellent efficiency, offers twelve-level speed and torque selection, but it can also be used for many jobs that would have normally required a much heavier tool. The brushless motor guarantees particularly quick work progress with maximum efficiency.

**Unique Metabo brushless motor** for quick work progress and highest efficiency for any application

**High torque** accompanied by an exceptionally compact design

**Integrated working light** for illumination of the work area

**Low kick-back working** with extremely high torque

**Twelve speed/torque settings** for a wide range of applications.

**With practical belt hook,** can be mounted on the right or left side



SSW 18 LTX 400 BL



For working with screwdriver bits you can use the adapter 628836000 (accessory).



For powerful screwdriving with high torque with low reverse torque at the same time



For example, the Metabo Impact Bits have a 70% higher service life.

## 18 V



Technical data	Cordless Impact Driver SSD 18 LTX 200 BL	Cordless Impact Wrench SSW 18 LTX 300 BL	Cordless Impact Wrench SSW 18 LTX 400 BL	Cordless Impact Wrench SSW 18 LTX 600
Type of battery pack	Li-Ion / LiHD	Li-Ion / LiHD	Li-Ion / LiHD	Li-Ion / LiHD
Battery pack voltage	18 V	18 V	18 V	18 V
Max. no-load speed	0 - 2,900 /min	0 - 2,650 /min	0 - 2,150 /min	0 - 1,600 /min
Maximum impact rate	4,000 /min	3,750 /min	4,250 /min	2,200 /min
Maximum torque	200 Nm	300 Nm	400 Nm	600 Nm
Speed/torque levels	12	12	12	1
Bit retainer	Hexagon recess 1/4" (6.35 mm)	Male square 1/2" (12.70 mm)	Male square 1/2" (12.70 mm)	Male square 1/2" (12.70 mm)
Weight (including battery pack)	1.4 kg	1.5 kg	1.7 kg	3.2 kg

Scope of delivery	602396 <sup>1)</sup>	602395 Available from September 2018	602205	602198
Belt hook	■	■	■	■
2 LiHD battery packs (18 V/5.5 Ah)	■	■	■	■
2 LiHD battery packs (18 V/4.0 Ah)	■	■	■	■
Charger ASC 30-36 V »AIR COOLED«	■	■	■	■
Plastic carry case	■	■	■	■

Equipment variants can be found in the Metabo price list and on the internet  
<sup>1)</sup> also available in 120 V (North/Latin America)

### Product advantages

- Cordless impact driver with 1/4" hexagonal recess and 200 Nm
- Cordless impact driver with 1/2" male square and 300 Nm
- High torque of 400 Nm whilst offering a particularly handy design
- Extremely powerful with 600 Nm for heavy screwdriving applications
- Automatic Power Shift (APS) supports working with self-tapping screws: automatic torque reduction after drilling to prevent overtightening.
- Robust die cast aluminium gear housing for optimum heat dissipation and long service life
- Unique Metabo brushless motor for quick work progress and highest efficiency for any application
- Twelve speed/torque levels for a wide range of applications
- High torque machine with low kick-back
- Integrated work light for illumination of the work area
- Handy belt hook, can be fixed either on the right or left side
- Battery packs with capacity display for checking the charge status

### System components

- Accessories → 315
- Battery packs → 72

# Compact, light and dust-free: The cordless hammer with dust extraction.

With immediate effect, the annoying dust when drilling in concrete, stone and masonry is a thing of the past if you use the new cordless combination hammer KHA 18 LTX BL 24 Quick with integrated dust extraction ISA 18 LTX 24. The HEPA filter catches even very small dust particles and thus permits healthier, dust-free drilling. Especially when working overhead and in areas susceptible to dust, this compact and light hammer is unbeatable.



**Metabo S-automatic safety clutch**  
Double safe thanks to electronic and mechanical safety shutdown when the drill stops unexpectedly



**Metabo Quick**  
Fast, tool-free chuck for working with SDS-plus and straight shank drill bits



**Integrated dust extraction**  
for dust-free drilling in concrete, stone and masonry

**BRUSHLESS MOTOR**

**Maximum drill performance, efficiency and service life** thanks to brushless technology and high-performance hammer action



**Vario Tacho Constamatic (VTC) Electronics** for drilling jobs in materials requiring customised speeds, which remain almost constant under load



**Metabo VibraTech (MVT)** Working, also continuously, in a low-fatigue manner whilst protecting the user's health

KHA 18 LTX BL 24 Quick with ISA 18 LTX 24



**Combination hammer with 3 functions**  
Hammer drilling, drilling and chiselling



**Extremely light and compact dust extraction**  
Ideal for working overhead or in areas sensible to dust



**Health-friendly working** with HEPA filter for smallest dust particles

# 18 V

## Technical data

	Cordless Combination Hammer KHA 18 LTX BL 24 Quick	Cordless Combination Hammer KHA 18 LTX BL 24 Quick Set ISA
Type of battery pack	Li-Ion / LiHD	Li-Ion / LiHD
Battery pack voltage	18 V	18 V
Max. single-impact energy (EPTA)	2.2 J	2.2 J
Maximum impact rate	4,500 /min	4,500 /min
Drill-Ø concrete with hammer drills	24 mm	24 mm
Drill-Ø masonry with core bits	68 mm	68 mm
Drill Ø steel	13 mm	13 mm
Drill-Ø soft wood	25 mm	25 mm
No-load speed	0 - 1,200 /min	0 - 1,200 /min
Bit retainer	SDS-plus	SDS-plus
Weight (including battery pack)	3.7 kg	4.5 kg

## Scope of delivery

Order no.	600211660	600211930 <sup>1)</sup>
Integrated dust extraction ISA 18 LTX 24		■
Replacement extraction head		■
Hammer chuck for tools with SDS-plus shank end	■	■
Keyless chuck for tools with cylindrical shank	■	■
Rubber-coated side handle	■	■
Drilling depth guide	■	■
2 LiHD battery packs (18 V/5.5 Ah)	■	
LiHD battery pack (18 V/5.5 Ah)		■
LiHD Battery pack (18 V/4.0 Ah)		■
Charger ASC 30-36 V »AIR COOLED«	■	■
Plastic carry case	■	■

Equipment variants can be found in the Metabo price list and on the internet  
<sup>1)</sup> also available in 120 V (North/Latin America)

## Product advantages

- Dust-free drilling with compact dust extraction ISA 18 LTX 24 (accessory)
- Dust-free drilling with compact dust extraction ISA 18 LTX 24
- Extremely light and compact cordless hammer with integrated extraction interface
- Maximum drill performance, efficiency and service life thanks to brushless technology and high-performance hammer action
- Combination hammer with 3 functions: hammer drilling, drilling and chiselling
- Metabo VibraTech (MVT): working, also continuously, in a low-fatigue manner whilst protecting the user's health
- Metabo Quick: fast, tool-free chuck for working with SDS-plus and straight shank drill bits
- Vario Constamatic (VTC) Electronics for drilling jobs in materials requiring customised speeds, which remain almost constant under load
- Double safe thanks to electronic and mechanical safety shutdown when the drill stops unexpectedly
- LED work light for optimum view of the drilling site

## System components

Accessories → 79, 289

Battery packs → 72

01

02

03

04

05

06

07

08

09

10

11

12

13

14

15

18 V  
2x 18 V



Technical data	Cordless Combination Hammer KHA 18 LTX	Cordless combination hammer KHA 36-18 LTX 32*
Type of battery pack	Li-Ion / LiHD	Li-Ion / LiHD
Battery pack voltage	18 V	18 V
Max. single-impact energy (EPTA)	2.2 J	3.1 J
Maximum impact rate	4,000 /min	4,500 /min
Drill-Ø concrete with hammer drills	24 mm	32 mm
Drill-Ø masonry with core bits	68 mm	68 mm
Drill Ø steel	13 mm	13 mm
Drill-Ø soft wood	25 mm	30 mm
No-load speed	0 - 1,100 /min	0 - 1,100 /min
Bit retainer	SDS-plus	SDS-plus
Weight (including battery pack)	2.9 kg	5.8 kg

Scope of delivery

Order no.	600210	600796
Hammer chuck for tools with SDS-plus shank end	■	■
Keyless chuck for tools with cylindrical shank		■
Rubber-coated side handle	■	
Metabo VibraTech (MVT) side handle		■
Drilling depth guide	■	■
Carrying strap	■	
2 LiHD battery packs (18 V/4.0 Ah)	■	
4 LiHD battery packs (18 V/8.0 Ah)		■
Charger ASC 30-36 V »AIR COOLED«	■	
2 Quick chargers ASC Ultra »AIR COOLED«		■
Plastic carry case	■	
MetaLoc case		■

Product advantages

- LED work light for optimum view of the drilling site
- 100% compatibility with the 18 Volt class: powerful 36 Volt operation with two 18 Volt battery packs from Metabo
- Metabo VibraTech (MVT): working, also continuously, in a low-fatigue manner whilst protecting the user's health
- Ergonomic housing shape for chiselling tasks without side handle
- Metabo Quick: fast, tool-free chuck for working with SDS-plus and straight shank drill bits
- Combination hammer with 3 functions: hammer drilling, drilling and chiselling
- Variospeed (V) Electronics for working at customised speeds to suit various application materials
- Metabo S-automatic safety clutch: mechanical decoupling of the drive for safe working should the drill stop unexpectedly
- Battery packs with capacity display for checking the charge status

System components

Accessories → 289

Battery packs → 72

\*36V version → 69

18 V



Technical data	Cordless Stirrer RW 18 LTX 120
Type of battery pack	Li-Ion / LiHD
Battery pack voltage	18 V
No-load speed	0 - 750 /min
Gears	1
Maximum stirring paddle diameter	120 mm
Max. recommended mixing amount	40 l
Bit retainer	Female thread M 14
Weight (including battery pack)	4.4 kg

Scope of delivery

Order no.	601163
Stirrer paddle RS-R2	■
2 LiHD battery packs (18 V/5.5 Ah)	■
Charger ASC 30-36 V »AIR COOLED«	■

Product advantages

- Cordless stirrer for powerful mixing on the construction site
- Minor effort to guide the stirrer thanks to ergonomically favourable handle position
- Battery pack is protected by its location on the top and helps to ensure perfect balance when stirring
- Vario Constamatic (VC) Electronics for work with materials requiring customised speeds, which remain almost constant under load
- Overload protection: protects the motor from overheating
- Electronic soft start for splash-free working
- Battery packs with capacity display for checking the charge status

System components

Accessories → 318

Battery packs → 72

18 V



Technical data	Cordless Tapper GB 18 LTX BL Q I
Type of battery pack	Li-Ion / LiHD
Battery pack voltage	18 V
Maximum torque - soft	60 Nm
Maximum torque, hard	120 Nm
Adjustable torque	1 - 20 Nm
Thread diameter	M4 - M12
Drill Ø steel	13 mm
Drill-Ø soft wood	65 mm
No-load speeds	0 - 600 / 0 - 2,050 /min
Chuck capacity	1.5 - 13 mm
Weight (including battery pack)	2.5 kg

Scope of delivery

Order no.	603828
Quick-change tapping chuck M4-M6	■
Quick-change tapping chuck M8-M12	■
Side handle	■
Belt hook and bit case	■
2 LiHD battery packs (18 V/5.5 Ah)	■
Charger ASC 30-36 V »AIR COOLED«	■

Product advantages

- High-grade cordless drill/screwdriver with unique, patented thread-tapping function
- Quick and interruption-free cutting and cleaning of threads thanks to automatic change of direction of rotation
- Two quick-change tapping chuck for inserting taps with square and cylindrical shanks
- Metabo Quick System: quick change of bit retainer and bits, for flexible working
- Unique Metabo brushless motor for quick work progress and highest efficiency when drilling and screwdriving
- Selectable "impuls" mode for removal of stubborn screws and for spot-drilling on smooth surfaces
- Overload protection: protects the motor from overheating
- Spindle with hexagonal recess for screwdriver bits for working without chuck
- Collar (Ø 43 mm) for versatile use
- Integrated working light to illuminate the contact area
- Robust die cast aluminium gear housing for optimum heat dissipation and long service life
- Battery packs with capacity display for checking the charge status

System components

Accessories → 76, 252

Battery packs → 72

18 V



Technical data	Cordless Flat-head Angle Grinder WF 18 LTX 125 Quick
Type of battery pack	Li-Ion / LiHD
Battery pack voltage	18 V
Minimum accessible angle	43 °
Grinding wheel Ø	125 mm
No-load speed	8,000 /min
Spindle threads	M 14
Weight (including battery pack)	2.4 kg

Scope of delivery	Order no.	601306
1 Flap disc Flexiamant Super Convex (125 mm; P60)		■
Guard		■
Inner support flange		■
Quick-locking nut		■
Side handle		■
Dust protection filter		■
2 Li-Power battery packs (18 V/5.2 Ah)		■
Charger ASC 30-36 V »AIR COOLED«		■
Plastic carry case		■

Equipment variants can be found in the Metabo price list and on the internet

**Product advantages**

- Extremely flat gear head permits working within acute angles down to 43°
- Compact design for quick removal of welding slag, rust or paint in confined spaces e.g. frame constructions
- Low-fatigue working even on weld seams in difficult to access places thanks to slim handle
- Robust motor for long service life
- Metabo Quick for tool-free disc change by means of a quick-locking nut
- Tool-free adjustable guard; twist-proof
- Battery pack can be swivelled for better access in hard to reach places
- Detachable dust protection filter protects motor from coarse particles
- Overload protection: protects the motor from overheating
- Electronic soft start for smooth start-up
- Restart protection: prevents unintentional start-up after power supply interruption
- Battery packs with capacity display for checking the charge status

**System components**

Accessories → 87 | Battery packs → 72

18 V



Technical data	Cordless Angle Grinder W 18 LTX 115 Quick	Cordless Angle Grinder W 18 LTX 125 Quick
Type of battery pack	Li-Ion / LiHD	Li-Ion / LiHD
Battery pack voltage	18 V	18 V
Grinding wheel Ø	115 mm	125 mm
No-load speed	8,000 /min	8,000 /min
Spindle threads	M 14	M 14
Weight (including battery pack)	2.4 kg	2.4 kg

Scope of delivery	Order no.	602170	602174
Guard		■	■
Inner support flange		■	■
Quick-locking nut		■	■
Side handle		■	■
Dust protection filter		■	■
2 Li-Power battery packs (18 V/5.2 Ah)			■
Charger ASC 30-36 V »AIR COOLED«			■
Plastic carry case			■
MetaLoc case insert		■	
without battery pack, without charger		■	

Equipment variants can be found in the Metabo price list and on the internet

**Product advantages**

- Slim design for prolonged comfort when working overhead or in areas with limited space
- Metabo Quick for tool-free disc change by means of a quick-locking nut
- Tool-free adjustable guard; twist-proof
- Battery pack can be swivelled for better access in hard to reach places
- Overload protection: protects the motor from overheating
- Electronic soft start for smooth start-up
- Restart protection: prevents unintentional start-up after power supply interruption
- Detachable dust protection filter protects motor from coarse particles
- Battery packs with capacity display for checking the charge status

**System components**

Accessories → 130 | Battery packs → 72

01

02

03

04

05

06

07

08

09

10

11

12

13

14

15

18 V



Inox



Technical data	Cordless Angle Grinder W 18 LTX 125 Quick Inox	Cordless Angle Grinder WP 18 LTX 125 Quick
Type of battery pack	Li-Ion / LiHD	Li-Ion / LiHD
Battery pack voltage	18 V	18 V
Grinding wheel Ø	125 mm	125 mm
No-load speed	5,000 /min	8,000 /min
Spindle threads	M 14	M 14
Weight (including battery pack)	2.4 kg	2.4 kg

Scope of delivery

Order no.	600174	613072
Guard	■	■
Inner support flange	■	■
Quick-locking nut	■	■
Side handle	■	■
Dust protection filter	■	■
MetaLoc case insert	■	■
without battery pack, without charger	■	■

Equipment variants can be found in the Metabo price list and on the internet

Product advantages

- Speed and torque configured precisely for stainless steel processing ensuring a cool grinding action with perfect finish
- Paddle switch with dead man function: safe to operate due to an ergonomically integrated non-slip switch
- Slim design for prolonged comfort when working overhead or in areas with limited space
- Metabo Quick for tool-free disc change by means of a quick-locking nut
- Tool-free adjustable guard; twist-proof
- Battery pack can be swivelled for better access in hard to reach places
- Overload protection: protects the motor from overheating
- Electronic soft start for smooth start-up
- Restart protection: prevents unintentional start-up after power supply interruption
- Detachable dust protection filter protects motor from coarse particles

System components

Accessories → 130

Battery packs → 72

18 V



Technical data	Cordless Angle Grinder WB 18 LTX BL 125 Quick	Cordless Angle Grinder WPB 18 LTX BL 125 Quick
Type of battery pack	Li-Ion / LiHD	Li-Ion / LiHD
Battery pack voltage	18 V	18 V
Grinding wheel Ø	125 mm	125 mm
No-load speed	9,000 /min	9,000 /min
Spindle threads	M 14	M 14
Weight (including battery pack)	2.7 kg	2.8 kg

Scope of delivery

Order no.	613077	613075
Guard	■	■
Inner support flange	■	■
Quick-locking nut	■	■
Side handle	■	■
Dust protection filter	■	■
2 LiHD battery packs (18 V/5.5 Ah)	■	■
Charger ASC 30-36 V »AIR COOLED«	■	■
Plastic carry case	■	■

Equipment variants can be found in the Metabo price list and on the internet

Product advantages

- Paddle switch with dead man function: safe to operate due to an ergonomically integrated non-slip switch
- Unique encapsulated Metabo brushless motor with optimum protection from dust provides quick work progress and the highest efficiency
- Slim design for prolonged comfort when working overhead or in areas with limited space
- Fast brake system with safety spindle for highest user safety: stops the disc within 2 seconds after switching off and prevents the nut from coming loose during the braking process
- Metabo Quick for tool-free disc change by means of a quick-locking nut
- Tool-free adjustable guard; twist-proof
- Battery pack can be swivelled for better access in hard to reach places
- Electronic safety shutdown: reduces kickback if the disc stops unexpectedly - for high user safety
- Overload protection: protects the motor from overheating
- Electronic soft start for smooth start-up
- Restart protection: prevents unintentional start-up after power supply interruption
- Detachable dust protection filter protects motor from coarse particles
- Battery packs with capacity display for checking the charge status

System components

Accessories → 130

Battery packs → 72

01

02

03

04

05

06

07

08

09

10

11

12

13

14

15

# 18 V



Technical data	Cordless Angle Grinder W 18 LTX 150 Quick	Cordless Angle Grinder WB 18 LTX BL 150 Quick	Cordless Angle Grinder WB 18 LTX BL 180
Type of battery pack	Li-Ion / LiHD	Li-Ion / LiHD	Li-Ion / LiHD
Battery pack voltage	18 V	18 V	18 V
Grinding wheel Ø	150 mm	150 mm	180 mm
No-load speed	8,000 /min	9,000 /min	8,200 /min
Spindle threads	M 14	M 14	M 14
Weight (including battery pack)	2.4 kg	2.6 kg	2.6 kg

### Scope of delivery

Order no.	600404	613078	613087
Clip for cut-off guard	■		
Guard	■	■	■
2 Flexiarapid Inox cutting discs (150x1.6x22.2 mm)	■		
Inner support flange	■	■	■
Nut with two holes			■
Quick-locking nut	■	■	
Side handle	■	■	■
Dust protection filter	■	■	■
Flat-pin spanners			■
2 Li-Power battery packs (18 V/5.2 Ah)	■		
Charger ASC 30-36 V »AIR COOLED«	■		
Plastic carry case	■		
MetaLoc case			■
without battery pack, without charger		■	■

### Product advantages

- Metabo Quick for tool-free disc change by means of a quick-locking nut
- Same cutting depth like a large mains angle grinder with Ø 230 mm; ideal for cutting jobs on the roof
- Unique encapsulated Metabo brushless motor with optimum protection from dust provides quick work progress and the highest efficiency
- Fast brake system for highest user safety stops the disc within a matter of seconds after switching off
- Electronic safety shutdown: reduces kickback if the disc stops unexpectedly - for high user safety
- Slim design for prolonged comfort when working overhead or in areas with limited space
- Tool-free adjustable guard; twist-proof
- Battery pack can be swivelled for better access in hard to reach places
- Detachable dust protection filter protects motor from coarse particles
- Overload protection, soft start and restart protection
- Battery packs with capacity display for checking the charge status

### System components

Accessories → 130 | Battery packs → 72

# 2x 18 V

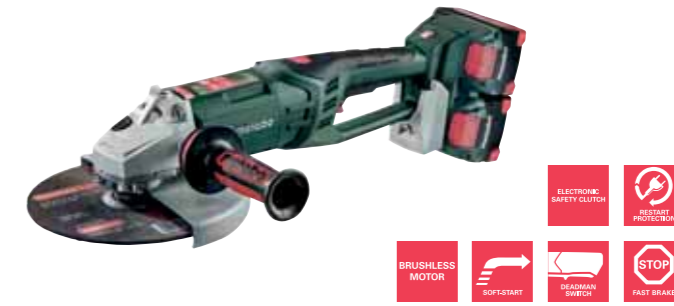

Technical data	Cordless Angle Grinder WPB 36-18 LTX BL 230*
Type of battery pack	Li-Ion / LiHD
Battery pack voltage	18 V
Grinding wheel Ø	230 mm
No-load speed	6,600 /min
Spindle threads	M 14
Weight (including battery pack)	6.9 kg

### Scope of delivery

Order no.	613102 <sup>1)</sup>
Guard	■
Inner support flange	■
Nut with two holes	■
Metabo VibraTech (MVT) side handle	■
Flat-pin spanners	■
4 LiHD battery packs (18 V/8.0 Ah)	■
2 Quick chargers ASC Ultra »AIR COOLED«	■
Plastic carry case	■
MetaLoc case	■

<sup>1)</sup> also available in 120 V (North/Latin America)

### Product advantages

- World's first large angle grinder (Ø 230 mm) with battery pack operation for powerful cutting and roughing independent from the mains power
- 100% compatibility with the 18 Volt class: powerful 36 Volt operation with two 18 Volt battery packs from Metabo
- Widest range of application thanks to extremely large cutting depth of 77 mm
- Unique encapsulated Metabo brushless motor with optimum protection from dust provides quick work progress and the highest efficiency
- Deadman's switch for high user safety
- Fast brake system for highest user safety stops the disc within a matter of seconds after switching off
- Rotating main handle: high safety and better handling when cutting
- Metabo VibraTech (MVT) side handle for vibration damping to protect the user's health
- Side handle can be mounted in three positions
- Electronic safety shutdown: reduces kickback if the disc stops unexpectedly - for high user safety
- Overload protection, soft start and restart protection
- Battery packs with capacity display for checking the charge status

### System components

Accessories → 130 | Battery packs → 72

\*36V version → 68

01

02

03

04

05

06

07

08

09

10

11

12

13

14

15





18 V



Technical data	Cordless Band File BF 18 LTX 90
Type of battery pack	Li-Ion / LiHD
Battery pack voltage	18 V
Belt speed in idle	8 m/s
Grinding belt width	6 - 19 mm
Grinding belt length	457 mm
Useful length of sanding belt arm	90 mm
Weight (including battery pack)	2.6 kg

Scope of delivery	Order no.
Order no.	600321
Side handle	■
Dust protection filter	■
Sanding belt arm 1 (for belt width 6 and 13 mm)	■
Hexagonal wrench	■
without battery pack, without charger	■

- Product advantages**
- Powerful, compact cordless band file for grinding, satin-finish and deburring in places difficult to reach
  - Robust motor for long service life
  - Tool-free sanding belt change and adjustable belt guide
  - Grinding attachment can be swivelled by 270° without tools for perfect adaptation to any working position
  - Battery pack can be swivelled for better access in hard to reach places
  - Detachable dust protection filter protects motor from coarse particles
  - Overload protection: protects the motor from overheating
  - Electronic soft start for smooth start-up
  - Restart protection: prevents unintentional start-up after power supply interruption

**System components**

Accessories → 181 | Battery packs → 72



18 V



Technical data	Cordless Fillet Weld Grinder KNS 18 LTX 150
Type of battery pack	Li-Ion / LiHD
Battery pack voltage	18 V
No-load speed	3,800 /min
Disc diameter	150 mm
Spindle threads	M 14
Weight (including battery pack)	3 kg

Scope of delivery	Order no.
Order no.	600191
Guard	■
Inner support flange	■
Nut with two holes	■
Side handle	■
Dust protection filter	■
Flat-pin spanners	■
Hexagonal wrench	■
without battery pack, without charger	■

- Product advantages**
- Very flat cordless fillet weld grinder for processing stainless steel weld seams in tight spaces
  - Robust motor for long service life
  - Adjustable without tools, removable guard
  - Low-maintenance belt drive for long service life
  - Battery pack can be swivelled for better access in hard to reach places
  - Detachable dust protection filter protects motor from coarse particles
  - Overload protection: protects the motor from overheating
  - Electronic soft start for smooth start-up
  - Restart protection: prevents unintentional start-up after power supply interruption

**System components**

Accessories → 183 | Battery packs → 72



18 V



Technical data	Cordless Burnishing Machine S 18 LTX 115
Type of battery pack	Li-Ion / LiHD
Battery pack voltage	18 V
No-load speed	3,000 /min
Spindle threads	M 14
Abrasive tool diameter	100 - 200 mm
Abrasive tool width	50 - 100 mm
Weight (including battery pack)	3.1 kg

Scope of delivery	Order no.
Order no.	600154
Side handle	■
Dust protection filter	■
without battery pack, without charger	■

- Product advantages**
- Compact cordless burnishing machine for grinding, satin-finish, brushing and high-gloss polishing of e.g. stainless steel
  - Robust motor for long service life
  - Spindle lock and tool-free flange nut for fast accessory change
  - Fast and tool-free adjustment of guard and side handle
  - Smooth-running, form-fit roller arbor for a uniform grinding result
  - Battery pack can be swivelled for better access in hard to reach places
  - Detachable dust protection filter protects motor from coarse particles
  - Overload protection: protects the motor from overheating
  - Electronic soft start for smooth start-up
  - Restart protection: prevents unintentional start-up after power supply interruption

**System components**

Accessories → 186 | Battery packs → 72



18 V



Technical data	Cordless Tube Belt Sander RB 18 LTX 60
Type of battery pack	Li-Ion / LiHD
Battery pack voltage	18 V
Belt speed in idle	9.2 m/s
Grinding belt dimensions	30 x 533 mm
Maximum pipe diameter	60 mm
Wrap angle	190 °
Weight (including battery pack)	3.3 kg

Scope of delivery	Order no.
Order no.	600192
Dust protection filter	■
without battery pack, without charger	■

- Product advantages**
- Compact cordless tube belt sander for quick, flexible processing of stainless steel pipes
  - Large wrap angle of 190° for smooth surfaces
  - Robust motor for long service life
  - Tool-free sanding belt change and adjustable belt guide
  - Battery pack can be swivelled for better access in hard to reach places
  - Detachable dust protection filter protects motor from coarse particles
  - Overload protection: protects the motor from overheating
  - Electronic soft start for smooth start-up
  - Restart protection: prevents unintentional start-up after power supply interruption

**System components**

Accessories → 194 | Battery packs → 72

01

02

03

04

05

06

07

08

09

10

11

12

13

14

15

18 V



Technical data	Cordless Die Grinder GA 18 LTX	Cordless Die Grinder GPA 18 LTX	Cordless Die Grinder GA 18 LTX G
Type of battery pack	Li-Ion / LiHD	Li-Ion / LiHD	Li-Ion / LiHD
Battery pack voltage	18 V	18 V	18 V
No-load speed	25,000 /min	25,000 /min	6,000 /min
Collar diameter	43 mm	43 mm	43 mm
Collet chuck bore	6 mm	6 mm	6 mm
Weight (including battery pack)	2.1 kg	2.1 kg	2.2 kg

Scope of delivery

Order no.	600638	600621 <sup>1)</sup>	600639 <sup>1)</sup>
Collet 6 mm	■	■	■
Protective rubber cap	■	■	■
Side handle			■
Dust protection filter	■	■	■
Open-jawed spanner	■	■	■
2 Li-Power battery packs (18 V/5.2 Ah)	■	■	■
Charger ASC 30-36 V »AIR COOLED«	■	■	
Plastic carry case	■	■	
without battery pack, without charger			■

Equipment variants can be found in the Metabo price list and on the internet  
<sup>1)</sup> also available in 120 V (North/Latin America)

Product advantages

- Spindle lock for simple change of tools
  - Restart protection: prevents unintentional start-up after power supply interruption
  - Overload protection: protects the motor from overheating
  - Removable protective rubber cap for comfortable and safe working
  - Slim design for ideal handling
  - Precision collet for precise concentricity
  - Detachable dust protection filter protects motor from coarse particles
  - Battery packs with capacity display for checking the charge status
- Paddle switch with dead man function: safe to operate due to an ergonomically integrated non-slip switch
  - High torque and compact design thanks to robust planetary gear train

System components

Accessories → 202 | Battery packs → 72

18 V



Technical data	Cordless Beveling Tool KFM 18 LTX 3 RF
Type of battery pack	Li-Ion / LiHD
Battery pack voltage	18 V
No-load speed	7,000 /min
Type of edges	Chamfer and radius
Max. chamfer width 45°	6 mm
Max. chamfer height at 45°	4 mm
Possible radii	R2 / R3
Grading of cutting depth setting	0.1 mm
Curves smallest internal Ø	13 mm
Weight (including battery pack)	3.1 kg

Scope of delivery

Order no.	601754 <sup>1)</sup>
2 Carbide indexable inserts 45° chamfer	■
2 Carbide indexable inserts radius R2	■
2 Carbide indexable inserts radius R3	■
Guide stop	■
Screwdriver Torx 15	■
Front handle	■
Dust protection filter	■
2 LiHD battery packs (18 V/5.5 Ah)	■
Charger ASC 30-36 V »AIR COOLED«	■
MetaLoc case	■

Equipment variants can be found in the Metabo price list and on the internet  
<sup>1)</sup> also available in 120 V (North/Latin America)

Product advantages

- The most powerful cordless metal beveling tool for 45° chamfers up to 4 mm and radii of 2 and 3 mm
- Surfaces free from oxide and burrs as ideal preparation for the application of powder or paint coatings for maximum protection from corrosion
- One-touch controller: Patented, tool-free setting of the cutting depth in 0.1 mm steps; stop points for short setting times, and protection against unintentional adjustment of the cutting depth when working
- Slim milling head for working on tubes, on bores from Ø 13 mm, and on exterior contours
- Parallel guide / rip fence for a uniform finish when processing straight edges
- Battery pack can be swivelled for better access in hard to reach places
- Overload protection: protects the motor from overheating
- Electronic soft start for smooth start-up
- Restart protection: prevents unintentional start-up after power supply interruption
- Detachable dust protection filter protects motor from coarse particles

System components

Accessories → 214 | Battery packs → 72

18 V



Technical data	Cordless Blind Rivet Gun NP 18 LTX BL 5.0
Type of battery pack	Li-Ion / LiHD
Battery pack voltage	18 V
Rivet diameter	2.4 - 5 mm
Placement force	10,000 N
Weight (including battery pack)	2.2 kg

Scope of delivery

Order no.	619002
4 Retaining nozzles	■
Belt hook	■
2 LiHD battery packs (18 V/4.0 Ah)	■
Charger ASC 30-36 V »AIR COOLED«	■
MetaLoc case	■

Equipment variants can be found in the Metabo price list and on the internet

Product advantages

- Cordless rivet gun for extremely fast riveting, comparable to compressed air devices
- 100% compatible with all Metabo 18 Volt battery packs
- Long service life thanks to brushless motor and robust precision gearbox
- With retaining nozzles for one-hand operation: inserted rivet holds in any position
- Transparent collecting container for simple emptying of the remaining rivet mandrels
- Quick change of nozzle for different rivet diameters, via integrated tool
- Safety in the workplace thanks to robust knuckle guards
- LED light for optimum illumination when riveting; can be switched off for reflective surfaces
- Ergonomic design for comfortable working also in corners
- Robust eyelet for energy-saving work with balancer / spring tension
- Handy belt hook, can be fixed either on the right or left side
- Battery packs with capacity display for checking the charge status

System components

Accessories → 78 | Battery packs → 72

01  
02  
03  
04  
05  
06  
07  
08  
09  
10  
11  
12  
13  
14  
15

18 V



Technical data	Cordless Band Saw MBS 18 LTX 2.5
Type of battery pack	Li-Ion / LiHD
Battery pack voltage	18 V
Maximum cutting width	63.5 mm
Saw belt length	835 mm
Saw belt width	13 mm
Saw band speed	174 m/min
Weight (including battery pack)	4.1 kg

Scope of delivery	
Order no.	613022
Band saw blade 14/18 TPI	■
1 Li-Power battery pack (18 V/5.2 Ah)	■
Charger ASC 30-36 V »AIR COOLED«	■

**Product advantages**

- Light cordless band saw for precise, burr-free cuts in metal, aluminium and plastic
- Compact design for sawing in hard to reach places and overhead
- Material-friendly, almost spark-free sawing without coolant
- Low-fatigue working thanks to optimum centre of gravity and large rubberised areas of the handles
- Low-vibration saw blade running for precision cuts and comfortable working
- Tension and tracking of the band saw blade can be adjusted quickly and easily
- Metabo Quick for changing saw blades without tools
- Integrated LED work light for illumination of the cutting line
- Robust housing with solid metal stop and metal saw blade cover
- Integrated hanging hook for space-saving storage
- Conventional band saw blades in the respective size can be used
- Battery packs with capacity display for checking the charge status

**System components**

Accessories → 448 | Battery packs → 72

18 V



Technical data	Cordless Circular Saw KS 18 LTX 57
Type of battery pack	Li-Ion / LiHD
Battery pack voltage	18 V
Swivel range from / to:	0 °/+ 50 °
Adjustable cutting depth	0 - 57 mm
Maximum cutting depth at 90°	57 mm
Maximum cutting depth at 45°	43 mm
Saw blade Ø x bore	Ø 165 x 20 mm
No-load speed	4,600 /min
Max. cutting speed	40 m/s
Weight (including battery pack)	3.7 kg

Scope of delivery	
Order no.	601857
Carbide circular saw blade (18 teeth)	■
Parallel guide / Rip fence	■
Hexagonal wrench	■
2 LiHD battery packs (18 V/8.0 Ah)	■
Charger ASC 30-36 V »AIR COOLED«	■
MetaLoc case	■

Equipment variants can be found in the Metabo price list and on the internet

**Product advantages**

- Powerful, light, cordless circular saw for universal use on construction sites
- Aluminium base plate can be directly used on guide rails from Metabo and other manufacturers
- Fast brake stops the saw blade quickly and improves safety
- Accurately angled bevel cuts down to 50°, with handy snap-in point at 45°
- 0° position re-adjustable for highest cutting precision
- Clearly visible cutting indicator for precise sawing after initial cut
- Handle with non-slip soft-grip surface for safe guidance
- Extraction possibility by means of connecting an all-purpose vacuum cleaner
- Battery packs with capacity display for checking the charge status

**System components**

Accessories → 378 | Battery packs → 72

18 V



Technical data	Cordless Sabre Saw SSE 18 LTX Compact	Cordless Sabre Saw ASE 18 LTX
Type of battery pack	Li-Ion / LiHD	Li-Ion / LiHD
Battery pack voltage	18 V	18 V
Strokes in idle	0 - 3,100 /min	0 - 2,700 /min
Saw blade stroke	13 mm	30 mm
Weight (including battery pack)	1.9 kg	3.9 kg

Scope of delivery		
Order no.	602266	602269
Jigsaw blade for metal	■	
Sabre saw blade for wood and metal	■	
Hexagonal wrench		■
2 LiHD battery packs (18 V/5.5 Ah)		■
2 LiHD battery packs (18 V/4.0 Ah)	■	
Charger ASC 30-36 V »AIR COOLED«	■	■
Plastic carry case	■	■

Equipment variants can be found in the Metabo price list and on the internet

**Product advantages**

- Light, extremely handy saw for one or two handed operation
- Especially suitable for working in difficult to reach places
- Extended range of application thanks to unique Quick retainer for sabre saw blades and jigsaw blades
- Depth guide can be adjusted without tools for ideal utilisation of the saw blade and diverse applications such as plunge cuts
- Integrated LED work light for optimum illumination of the cutting line
- Slim, lightweight machine with soft-grip handle for comfortable sawing in every working position
- Robust die-cast aluminium gear housing, coated for optimum handling
- Variospeed (V) Electronics for working with customised stroke rates for the materials used
- Saw blade rotatable by 180° for working comfortably overhead
- Depth guide can be adjusted for ideal utilisation of the saw blade and diverse applications such as plunge cuts
- Metabo Quick for changing saw blades without tools
- Wide range of uses thanks to the adapted Metabo saw blade range
- Battery packs with capacity display for checking the charge status

**System components**

Accessories → 391, 406 | Battery packs → 72

01  
02  
03  
04  
05  
06  
07  
08  
09  
10  
11  
12  
13  
14  
15

18 V



Technical data	Cordless Jigsaw STAB 18 LTX 100	Cordless Jigsaw STA 18 LTX 100	Cordless Jigsaw STA 18 LTX 140
Type of battery pack	Li-Ion / LiHD	Li-Ion / LiHD	Li-Ion / LiHD
Battery pack voltage	18 V	18 V	18 V
Cutting depth wood	100 mm	100 mm	140 mm
Cutting depth NF metal	25 mm	25 mm	35 mm
Cutting depth sheet steel	10 mm	10 mm	10 mm
Swivel range from / to:	- 45 °/+ 45 °	- 45 °/+ 45 °	- 45 °/+ 45 °
Pendulum stroke levels	4	4	4
Strokes in idle	0 - 2,800 /min	550 - 2,800 /min	1,000 - 3,000 /min
Weight (including battery pack)	2.5 kg	2.4 kg	2.8 kg

Scope of delivery	601003	601002	601405
Order no.	601003	601002	601405
Extraction nozzles	■	■	■
Protective glass	■	■	■
Plastic guard plate	■	■	■
Chip guard plates	■	■	■
Jigsaw blade	■	■	■
Hexagonal wrench	■	■	■
2 LiHD battery packs (18 V/4.0 Ah)	■	■	■
Charger ASC 30-36 V »AIR COOLED«	■	■	■
Plastic carry case	■	■	■

Equipment variants can be found in the Metabo price list and on the internet

Product advantages

- Top handle with non-slip soft-grip surface
- Extremely powerful jigsaw with VTC-Electronics for fast cuts into soft wood of up to 140 mm deep
- Convenient auto start with automatic stroke rate acceleration
- Integrated LED work light for illumination of the cutting line
- Long service life thanks to optimum gear and motor design and robust die-cast aluminium gear housing
- Extremely handy due to small body circumference and soft-grip surface
- Precise and material-matched sawing due to the variable stroke rate, pendulum stroke and low-lying saw blade guidance with spring support
- Metabo Quick for tool-free saw blade change and with automatic ejection
- Selectable chip blowing function ensures free view of cutting line

System components

Accessories → 391 | Battery packs → 72

18 V

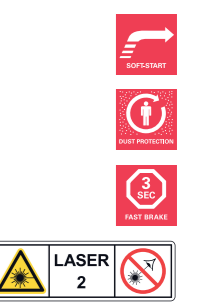
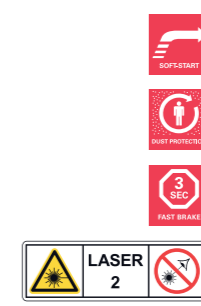

Technical data	Cordless Mitre Saw KS 18 LTX 216	Cordless mitre saw KGS 18 LTX 216 with sliding function
Type of battery pack	Li-Ion / LiHD	Li-Ion / LiHD
Battery pack voltage	18 V	18 V
Cutting capacity 90°/90°	120 x 60 mm	305 x 65 mm
Cutting capacity 45°/45°	80 x 45 mm	205 x 36 mm
Turntable setting left/right	47 °/47 °	47 °/47 °
Saw blade inclination left/right	47 °/2 °	47 °/2 °
Saw Blade	Ø 216 x 30 mm	Ø 216 x 30 mm
No-load speed	4,200 /min	4,200 /min
Max. cutting speed	48 m/s	48 m/s
Weight (including battery pack)	9.9 kg	13.9 kg

Scope of delivery	619000	619001
Order no.	619000	619001
Carbide saw blade (40 teeth)	■	■
2 Table width extensions	■	■
Length guide	■	■
Material clamp	■	■
Tool for saw blade change	■	■
Chip collection bag	■	■
2 LiHD battery packs (18 V/5.5 Ah)	■	■
2 LiHD battery packs (18V/8.0 Ah)	■	■
Charger ASC 30-36 V »AIR COOLED«	■	■

Equipment variants can be found in the Metabo price list and on the internet

Product advantages

- Up to 720 cuts in laminate 195 x 8 mm per battery pack charge (8.0 Ah)
- Sliding function for wide work pieces.
- Depth guide for easy creation of grooves
- Powerful cordless mitre saw perfect for assembly jobs with high volume of cuts
- Up to 340 cuts in soft wood 60 x 60 mm per battery pack charge (8.0 Ah)
- Compact light weight, suitable also for one-handed transport
- Easy transport thanks to ergonomically-designed handles and locking saw head
- Motor brake for quick stop of the saw blade in 3 seconds
- Robust die-cast aluminium design for the highest demands
- Effective internal chip and dust extraction via dust scoop and chip collection bag
- Fast and precise setting of common angles using stop points
- Cutting line laser and LED work light with energy-saving automatic shutoff
- Adjustable and extendable table width extensions, removable to put long panels, slabs etc. underneath
- Sliding high rear fence profiles for safe sawing
- Material clamp for secure fixing of the work piece from the top or front

System components

Accessories → 378, 441 | Battery packs → 72

2x 18 V



NEW



Technical data	Cordless Table Saw TS 36-18 LTX BL 254*
Type of battery pack	Li-Ion / LiHD
Battery pack voltage	18 V
Max. support surface	970 x 995 mm
Working height	850/355 mm
Cutting height	0 - 87 mm
Maximum cutting height 90/45°	87 mm/50 mm
Maximum cutting width at parallel guide/rip fence	630 mm
Maximum material width at mitre fence	200 mm
No-load speed	5,000 /min
Max. cutting speed	66 m/s
Saw Blade	Ø 254 x 30 mm
Saw blade swivel range	-1.5 - 46.5 °
Weight (including battery pack)	34.6 kg

Scope of delivery

Order no.	613025
Carbide saw blade with alternately bevel-ground tips (40 teeth)	■
Stand	■
Rubber tyres	■
Parallel guide / Rip fence	■
Mitre fence	■
Table length extension	■
Table width extension	■
Dust cycles	■
Textile dust bag	■
4 LiHD battery packs (18 V/8.0 Ah)	■
2 Quick chargers ASC Ultra »AIR COOLED«	■
Fixation strap for MetaLoc	■
MetaLoc case	■

Equipment variants can be found in the Metabo price list and on the internet

Product advantages

- Extremely light cordless table saw with trolley function for maximum mobility
- Powerful Metabo brushless motor for powerful sawing like with a mains-powered tool
- 100% compatibility with the 18 Volt class: powerful 36 Volt operation with two 18 Volt battery packs from Metabo
- Integrated extraction with dust cyclone for low-dust working without vacuum cleaner
- Quick change between sawing at ground-level or when standing up thanks to integrated, folding stand
- Precisely adjustable parallel guide / rip fence with double clamping and quick fastening
- Soft start and overload protection for long service life of motor and drive
- Splitting wedge can be lowered without tools for hidden cuts and transport
- MetaLoc case and attachments can be fixed at the housing for compact transport and storage

System components

Accessories → 378 | Battery packs → 72 | Extraction Systems → 453 | \*36V version → 70

18 V



Technical data	Cordless Multi-Tool MT 18 LTX
Type of battery pack	Li-Ion / LiHD
Battery pack voltage	18 V
Orbital frequency with no load	7,000 - 18,000 /min
Bit retainer	Compatible with OIS and Starlock
Oscillation angle left/right	1.6 °
Base plate, measurement from corner to corner	93 mm
Weight (including battery pack)	1.9 kg

Scope of delivery

Order no.	613021
Plunge saw blade 32 mm HCS (wood)	■
Segment saw blade 85 mm BiM (wood + metal)	■
Scraping knife, rigid 52 mm HCS	■
Triangular hook and loop sanding plate 93 mm	■
5 Hook and loop sanding sheets 93 mm P 80	■
5 Hook and loop sanding sheets 93 mm P 120	■
Suction adapter	■
Multi-adapter	■
2 LiHD battery packs (18 V/4.0 Ah)	■
Charger ASC 30-36 V »AIR COOLED«	■
Plastic carry case	■

Equipment variants can be found in the Metabo price list and on the internet

Product advantages

- Oscillating cordless multi-tool with high performance comparable to that of a mains powered version
- Indispensable for interior development such as cutting, sanding and scraping of different materials
- Tool holder for maximum compatibility to OIS, Starlock and other accessories
- Metabo Quick tool change system for time-saving, convenient change of accessories
- Fast and powerful thanks to the combination of a large oscillation angle of 3.2° and VTC-Electronics to maintain constant speed even under load
- Extra bright double LED lights for good visibility of the working area
- Slim design and non-slip soft-grip surface for optimised handling
- Extraction possibility by means of connecting an all-purpose vacuum cleaner
- Battery packs with capacity display for checking the charge status

System components

Accessories → 416 | Battery packs → 72

18 V



Technical data	Cordless Planer HO 18 LTX 20-82
Type of battery pack	Li-Ion / LiHD
Battery pack voltage	18 V
Planing width	82 mm
Adjustable planing depth	0 - 2 mm
Maximum notch depth	9 mm
No-load speed	16,000 /min
Length of planer base	295 mm
Weight (including battery pack)	3.5 kg

Scope of delivery

Order no.	602082
1 Set of disposable planer blades	■
Parallel guide / Rip fence	■
Depth gauge	■
Chip ejection adapter	■
Textile dust bags	■
2 Li-Power battery packs (18 V/4.0 Ah)	■
Charger ASC 30-36 V »AIR COOLED«	■
MetaLoc case	■

Equipment variants can be found in the Metabo price list and on the internet

Product advantages

- Light, compact cordless planer for planing, rebating and chamfering
- Adjustable planing depth and notch depth
- Aluminium die cast and milled cut planer base with V-groove for easy chamfering
- Parallel guide / rip fence for precise guiding of the planer
- Grip area with non-slip soft-grip surface
- Extraction possibility by means of connecting an all-purpose vacuum cleaner
- Angled chip ejection adapter for controlled ejection of the wood shavings
- Easy to empty textile dust bag for working without extraction facilities
- Strap on the planer base for stopping the machine and to protect the work piece
- Easy blade change of the robust reversible carbide planer blades
- Soft start and overload protection for long service life of motor and drive

System components

Accessories → 372 | Battery packs → 72

18 V



Technical data	Cordless Caulking Gun KPA 18 LTX 400	Cordless Caulking Gun KPA 18 LTX 600
Type of battery pack	Li-Ion / LiHD	Li-Ion / LiHD
Battery pack voltage	18 V	18 V
Discharge pressure	7,259 N / 740 kg	7,259 N / 740 kg
Holder size	400 ml	600 ml
Feed rate in idle	1 - 10 mm/s	1 - 10 mm/s
Suitable for	Cartridges, foil bags	Cartridges, foil bags
Weight (including battery pack)	2.8 kg	3 kg

Scope of delivery

Order no.	601206	601207
600 ml pipe		■
400 ml pipe	■	
Push plate for foil bag	■	■
Push plate for cartridges	■	■
Cartridge carrier	■	
Li-Power battery pack (18 V/2.0 Ah)	■	
LiHD Battery pack (18 V/4.0 Ah)		■
Charger SC 60 Plus	■	
Charger ASC 30-36 V »AIR COOLED«		■

Product advantages

- Extremely high discharge force, also suited for processing particularly viscous materials
- Infinitely variable setting of the discharge speed for precision working
- Metabo Quick: quick, tool-free change between cartridges and film bags
- No dripping thanks to automatic retraction of the gear rack
- Optimal material use thanks to almost complete discharge
- All-metal gear for long service life
- Battery packs with capacity display for checking the charge status

System components

Accessories → 78 | Battery packs → 72

18 V



NEW



Technical data	Cordless Vacuum Cleaner AS 18 L PC
Type of battery pack	Li-Ion / LiHD
Battery pack voltage	18 V
Air output max.	2,100 l/min
Vacuum	120 hPa (mbar)
Filter surface	3,600 cm²
Container volume	7.5 l
Suction hose Ø	27 mm
Hose length	3 m
Weight (including battery pack)	7.4 kg

Scope of delivery

Order no.	602021
Suction hose (Ø 27 mm / 3.0 m)	■
Fleece filter bag	■
Suction nozzle (120 mm wide)	■
Crevice nozzle	■
Carrying strap	■
2 Li-Power battery packs (18 V/5.2 Ah)	■
Charger ASC 30-36 V »AIR COOLED«	■

Equipment variants can be found in the Metabo price list and on the internet

Product advantages

- Light, compact cordless vacuum cleaner for mobile use for extraction and vacuuming of dust and chips
- Dry vacuum cleaner with commercial registration, certified in accordance with EU standard for L class dust
- PressClean: manual filter cleaning using strong air flow by activating the switch on the extraction unit during breaks
- With integrated blow function for blowing out, drying and drawing off exhaust air
- Eco mode for longer runtime per battery pack charge, boost mode for maximum power
- Large corner switch for easy switching On/Off also by foot operation
- Practical storage for second battery pack, charger, nozzles and hose (3 m)
- Compact MetaLoc design for stacking with the MetaLoc cases
- Robust housing with rubber protectors at the footprint for gentle, non-slip placement
- Easy transport with ergonomically-designed handle or carry strap
- Capacity display of the battery pack directly on the control panel of the vacuum cleaner

System components

Accessories → 462 | Battery packs → 72

01

02

03

04

05

06

07

08

09

10

11

12

13

14

15

14.4 V  
18 V



Technical data		Cordless Portable Lamp ULA 14.4-18 LED	Cordless Inspection Lamp SLA 14.4-18 LED
Type of battery pack		Li-Ion / LiHD	Li-Ion / LiHD
Max. luminous flux		280 lm	440 lm
Max. duration of illumination per battery pack charge		14.4 V / 2.0 Ah: 4.5 h 14.4 V / 4.0 Ah: 9 h 18 V / 2.0 Ah: 6.4 h 18 V / 4.0 Ah: 12.7 h 18 V / 5.2 Ah: 16.5 h 18 V / LiHD 4.0 Ah: 12.7 h 18 V / LiHD 5.5 Ah: 17.6 h 18 V / LiHD 8.0 Ah: 25.4 h	14.4 V / 2.0 Ah: 3.4 h 14.4 V / 4.0 Ah: 6.8 h 18 V / 2.0 Ah: 4.5 h 18 V / 4.0 Ah: 9.1 h 18 V / 5.2 Ah: 11.8 h 18 V / LiHD 4.0 Ah: 9.1 h 18 V / LiHD 5.5 Ah: 12.4 h 18 V / LiHD 8.0 Ah: 18.2 h
Weight (without battery pack)		0.39 kg	0.46 kg
Scope of delivery			
Order no.		600368	600370
without battery pack, without charger		■	■

- Product advantages**
- Powerful LED portable lamp for uniform, bright illumination of the working area
  - Lamp head can be tilted and locked in 12 positions
  - Compact and handy for versatile use
  - Robust aluminium die-cast housing for use on construction sites
  - Operation with all Li-Power and LiHD slide-on 14.4 and 18 Volt battery packs
  - Swivelling hook for suspending the lamp
- Powerful LED inspection lamp for uniform, bright illumination of the working area
  - Lamp head can be turned and swivelled through 180° providing almost infinite positions for the lamp

System components

Battery packs → 72

14.4 V  
18 V



Technical data		Cordless Site Light BSA 14.4-18 LED
Type of battery pack		Li-Ion / LiHD
Max. luminous flux		2,600 lm
Max. duration of illumination per battery pack charge		14.4 V / 2.0 Ah: 2.2 h 14.4 V / 4.0 Ah: 4.3 h 18 V / 2.0 Ah: 2.7 h 18 V / 4.0 Ah: 5.4 h 18 V / 5.2 Ah: 7.0 h 18 V / LiHD 4.0 Ah: 5.4 h 18 V / LiHD 5.5 Ah: 7.4 h 18 V / LiHD 8.0 Ah: 10.8 h
Weight (without battery pack)		2.5 kg
Scope of delivery		
Order no.		602111
without battery pack, without charger		■

- Product advantages**
- Powerful cordless site light with 18 LEDs for extensive and even illumination of the workplace and for flaw detection when surface processing
  - Operation with all Li-Power and LiHD slide-on 14.4 and 18 Volt battery packs
  - Robust and with a long service life for demanding applications on construction sites; housing and glass can be cleaned with a damp cloth
  - Very bright and pleasant light, inspired by daylight, with two illumination levels
  - Extremely long-lasting illumination of up to 10.8 hours per battery charge
  - Minimum heat generation: the spotlight only gets lukewarm for safe handling during continuous operation
  - Handle and light, compact design for quick change of position and for on the go
  - Spotlight can be swivelled quickly and continuously through 180°
  - Rubberised stand for secure positioning and gentle contact on delicate surfaces
  - Can also be suspended from a wall or mounted on a tripod

System components

Battery packs → 72

14.4 V  
18 V



Technical data		Cordless Power Adapter PA 14.4-18 LED-USB
Type of battery pack		Li-Ion / LiHD
Scope of delivery		
Order no.		600288
without battery pack, without charger		■

- Product advantages**
- Compact, multi-function adapter, can be used as desktop charger, energy source and lamp
  - Two fast USB connections for charging and operating of USB devices (max. charging current 2 A)
  - 12 Volt connection for the Metabo heated jacket
  - Bright LED light for close range
  - LED power light indicates operation; automatic shutdown after seven hours
  - Safe application thanks to automatic shutdown in case of overheating or short-circuit
  - Operation with all Li-Power and LiHD slide-on 14.4 and 18 Volt battery packs

01

02

03

04

05

06

07

08

09

10

11

12

13

14

15

18 V



NEW



NEW



Technical data	Cordless Worksite Radio R 12-18	Cordless Worksite Radio R 12-18 BT
Type of battery pack	Li-Ion / LiHD	Li-Ion / LiHD
Max. runtime per battery pack charge	14.4V / 2.0 Ah: 7.2 h 18V / 2.0 Ah: 9 h 18V / LiHD 4.0 Ah: 18 h 18V / LiHD 8.0 Ah: 32 h	14.4V / 2.0 Ah: 7.2 h 18V / 2.0 Ah: 9 h 18V / LiHD 4.0 Ah: 18 h 18V / LiHD 8.0 Ah: 32 h
Radio frequency AM	522 - 1,620 kHz	522 - 1,620 kHz
Radio frequency FM	87.5 - 108 MHz	87.5 - 108 MHz
Weight (without battery pack)	1.85 kg	1.85 kg

Scope of delivery	600776	600777
Order no.		
Mains cable	■	■
without battery pack	■	■

- Product advantages**
- Robust and compact AM/FM worksite radio
  - Robust and compact AM/FM worksite radio with Bluetooth for wireless music enjoyment from your smart phone or tablet
  - Operation with all Metabo slide-on battery packs from 12 to 18 volts or mains-powered
  - Robust plastic housing with protection class IP 54 - splash-proof, dust-proof and impact-proof
  - Station presets for AM/FM
  - Mains cable can be plugged in
  - Digital DSP tuner with illuminated LCD display and automatic station search
  - Flexible antenna

**System components**

Battery packs → 72

18 V



Technical data	Cordless Hedge Trimmer AHS 18-55 V
Type of battery pack	Li-Ion / LiHD
Battery pack voltage	18 V
Runtime per battery pack charge	70 min
Cutting thickness	18 mm
Cutting strength	53 cm
No of strokes (no load)	2,700 /min
Weight (including battery pack)	3.8 kg

Scope of delivery	600463
Order no.	
2 LiHD battery packs (18 V/4.0 Ah)	■
Charger ASC 30-36 V »AIR COOLED«	■
Storage slipcase	■

Equipment variants can be found in the Metabo price list and on the internet

- Product advantages**
- Blades with special geometry generate less wear and thus deliver 200% longer service life
  - Clean cut thanks to diamond-ground blade teeth on both sides at a 30° angle
  - Lower safety blade for high safety at work
  - Top cutting performance generated by double reduction gearing
  - Pleasant to work with thanks to low-vibration running, perfect ergonomics and soft-grip handle
  - Safety features include electronic blade quick stop (in 0.3 seconds)
  - Trigger guard with twig feed protects user and gearing from kickbacks
  - Battery packs with capacity display for checking the charge status

**System components**

Accessories → 575

Battery packs → 72

18 V



Technical data	Cordless Blower AG 18
Type of battery pack	Li-Ion / LiHD
Air volume	2.6 m³/min
Max. air velocity	74 m/s
Weight (including battery pack)	1.87 kg

Scope of delivery	602242
Order no.	
without battery pack, without charger	■

- Product advantages**
- Lightweight cordless blower e.g. for blowing off chips from workpieces, workplace, transporter etc.
  - Good ergonomics provided by a rubberised handle and an optimum centre of gravity
  - Robust design suitable for applications in the workshop and on the construction site
  - Vario (V) Electronics for continuously selectable blowing air velocity rate
  - Thumbwheel for preselection of 3 air velocity rate settings for varied output
  - Rubberised end piece of the blow tube to protect delicate surfaces
  - Comfortable blowing of floor areas using the supplied extension of the blow tube
  - Operation with all Li-Power and LiHD slide-on 18 Volt battery packs

01

02

03

04

05

06

07

08

09

10

11

12

13

14

15



18 V



Technical data	
<b>Cordless Fan AV 18</b>	
Type of battery pack	Li-Ion / LiHD
Air velocity	1.8 / 2.8 / 3.8 m/s
Maximum speed	1,300 /min
Rotor diameter	355 mm
Weight (including battery pack)	4.55 kg
Scope of delivery	
Order no.	606176
without battery pack, without charger	■

**Product advantages**

- High-quality cordless fan for flexible use, independent from mains power
- Battery pack operating time of up to 7 hours (at 5.2 Ah)
- Robust metal cage for maximum air throughput with minimum turbulence
- Adjustable tilting cage for flexible direction of air flow
- Air speed selectable via 3 levels
- Quiet operation even with highest level setting
- Stable tubular frame with rubber feet for safe positioning
- Prepared integrated mounting plate for mounting on a tripod or to the wall
- Operation with all Li-Power and LiHD slide-on 18 Volt battery packs

**System components**

Battery packs → 72

14.4 V  
18 V

Technical data	
<b>Cordless Heated Jacket HJA 14.4-18</b>	
Type of battery pack	Li-Ion / LiHD
Scope of delivery	
Size	Order no.
XS	657025
S	657026
M	657027
L	657028
XL	657029
XXL	657030
XXXL	657031
Power Adapter PA 14.4-18 LED-USB	■
without battery pack, without charger	■

**Product advantages**

- High-quality cordless heated jacket for work and leisure - warm, comfortable and versatile
- Six heating zones can be heated simultaneously or selectively at three different heating levels
- Warm hands thanks to two heated jacket pockets
- Up to 12 hours of comfortable warmth on level 1 or 5 hours of strong warmth on level 3 with one battery pack charge (18 V/5.2 Ah/all zones)
- Up to 5 hours of warmth on level 1 or 2 hours of warmth on level 3 when using a 18 V/2.0 Ah battery pack
- Extremely hard-wearing thanks to wind- and water-resistant, tear-proof material
- Outer material from 100% cotton, inner material and padding from 100% polyester
- One easy to reach battery pack pocket left behind the side seam
- Operation with all Li-Power and LiHD slide-on 14.4 and 18 Volt battery packs
- The jacket can also be operated with 10.8 V battery packs in connection with the smaller Metabo Power adapter PowerMaxx PA (order no. 606212000).

**Clever combination of battery pack power.**

10.8 V

**Combo Set 2.1 10.8 V Quick Pro**

- Cordless Drill / Screwdriver PowerMaxx BS Quick
  - Cordless Impact Driver PowerMaxx SSD
  - »Quick« Keyless Chuck
  - »Quick« quick change angle adapter
  - Li-Power battery pack (10.8 V/2.0 Ah)
  - Li-Power battery pack (10.8 V/4.0Ah)
  - Charger LC 40
  - In MetaLoc II
- Order no. 685053000**

18 V

**Combo Set 2.6.1 18V**

- Cordless Drill / Screwdriver BS 18
  - Cordless Multi-Tool MT 18 LTX
  - 2 Li-Power battery packs (18 V/2.0 Ah)
  - Charger SC 60 Plus
  - Plastic carry case
- Order no. 685081000**
- or with cordless impact drill SB 18 (instead of BS 18)
- Combo Set 2.6.2 18 V**  
**Order no. 685088000**

**Combo Set 2.3.2 18V**

- Cordless Drill / Screwdriver BS 18
  - Cordless Combination Hammer KHA 18 LTX
  - 2 Li-Power battery packs (18 V/2.0 Ah)
  - Charger SC 60 Plus
  - Plastic carry case
- Order no. 685083000**
- or with cordless impact drill SB 18 (instead of BS 18)
- Combo Set 2.3.4 18 V**  
**Order no. 685090000**

**Combo Set 2.2 10.8 V Quick Pro**

- Cordless Drill / Screwdriver PowerMaxx BS Quick
  - Cordless Sabre Saw PowerMaxx ASE
  - »Quick« Keyless Chuck
  - »Quick« quick change angle adapter
  - Li-Power battery pack (10.8 V/2.0 Ah)
  - Li-Power battery pack (10.8 V/4.0Ah)
  - Charger LC 40
  - In MetaLoc III
- Order no. 685054000**

**Combo Set 2.4.3 18V**

- Cordless Drill / Screwdriver BS 18
  - Cordless Angle Grinder W 18 LTX 125 Quick
  - Li-Power battery pack (18 V/2.0 Ah)
  - Li-Power battery pack (18 V/4.0Ah)
  - Charger SC 60 Plus
  - Plastic carry case
- Order no. 685082000**
- or with cordless impact drill SB 18 (instead of BS 18)
- Combo Set 2.4.4 18 V**  
**Order no. 685089000**

**Combo Set 2.3.3 18V**

- Cordless Drill / Screwdriver BS 18 LT Quick
  - Cordless Combination Hammer KHA 18 LTX
  - »Quick« Keyless Chuck
  - Quick-change bit holder »Quick«
  - »Quick« quick change angle adapter
  - 2 Li-Power battery packs (18 V/4.0 Ah)
  - Charger ASC 30-36 V »AIR COOLED«
  - MetaLoc III
- Order no. 685084000**

**Combo Set 2.5 10.8 V**

- Cordless Hammer Drill PowerMaxx SB Basic
  - Cordless Impact Driver PowerMaxx SSD
  - Keyless chuck
  - 2 Li-Power battery pack (10.8 V/2.0 Ah)
  - Charger LC 40
  - Plastic carry case
- Order no. 685091000**

**Combo Set 2.4.1 18 V**

- Cordless Drill / Screwdriver BS 18 LT
  - Cordless Angle Grinder W 18 LTX 125 Quick
  - 2 Li-Power battery packs (18 V/4.0 Ah)
  - Charger ASC 30-36 V »AIR COOLED«
  - In MetaLoc IV
- Order no. 685038000**
- or with cordless impact drill SB 18 LT (instead of BS 18 LT)
- Combo Set 2.4.2 18 V**  
**Order no. 685039000**

01

02

03

04

05

06

07

08

09

10

11

12

13

14

15

# 18 V LiHD



These combo sets are equipped with LiHD battery packs. This cordless generation offers you extra performance, service life and runtime. The combination of high-performance cells and new developed components ensure that maximum power is available for an extremely long time. A milestone on the way to the cordless construction site.



- Combo Set 2.1.11 18 V BL LiHD**
- Cordless Drill / Screwdriver BS 18 LT BL
  - Cordless Impact Driver SSD 18 LTX 200 BL
  - 2 LiHD battery packs (18 V/4.0 Ah)
  - Charger ASC 30-36 V
  - MetaLoc III
- Order no. 685123000**
- or with cordless hammer drill SB 18 LT BL (instead of BS 18 LT BL)
- Combo Set 2.1.12 18 V BL LiHD**  
**Order no. 685124000**



- Combo Set 2.1.13 18 V BL LiHD**
- Cordless Drill / Screwdriver BS 18 LTX BL Q I
  - Cordless Impact Driver SSD 18 LTX 200 BL
  - 2 LiHD battery packs (18 V/5.5 Ah)
  - Charger ASC 30-36 V
  - Quick-change bit holders »Quick«
  - MetaLoc III
- Order no. 685125000**
- or with cordless hammer drill SB 18 LTX BL Q I (instead of BS 18 LTX BL Q I)
- Combo Set 2.1.14 18 V BL LiHD**  
**Order no. 685126000**



- Combo Set 2.1.16 18 V BL LiHD**
- Cordless Drill / Screwdriver BS 18 LT BL
  - Cordless Impact Wrench SSW 18 LTX 300 BL
  - 2 LiHD battery packs (18 V/4.0 Ah)
  - Charger ASC 30-36 V
  - MetaLoc III
- Order no. 685128000**  
**Available from September 2018**



- Combo Set 2.1.17 18 V BL LiHD**
- Cordless Drill / Screwdriver BS 18 LTX BL Q I
  - Cordless Impact Wrench SSW 18 LTX 300 BL
  - 2 LiHD battery packs (18 V/5.5 Ah)
  - Charger ASC 30-36 V
  - Quick-change bit holders »Quick«
  - MetaLoc III
- Order no. 685129000**  
**Available from September 2018**



- Combo Set 2.1.9 18 V BL LiHD**
- Cordless Drill / Screwdriver BS 18 LT BL
  - Cordless Impact Wrench SSW 18 LTX 400 BL
  - Adapter 1/2" male square / 1/4" impact-proof
  - 2 LiHD battery packs (18 V/4.0 Ah)
  - Charger ASC 30-36 V
  - MetaLoc III
- Order no. 685137000**
- or with cordless hammer drill SB 18 LT BL (instead of BS 18 LT BL)
- Combo Set 2.1.10 18 V BL LiHD**  
**Order no. 685138000**



- Combo Set 2.3.6 18 V BL LiHD**
- Cordless Drill / Screwdriver BS 18 LT BL
  - Cordless Combination Hammer KHA 18 LTX BL 24 Quick
  - 2 LiHD battery packs (18 V/4.0 Ah)
  - Charger ASC 30-36 V
  - MetaLoc III
- Order no. 685139000**
- or with cordless hammer drill SB 18 LT BL (instead of BS 18 LT BL)
- Combo Set 2.3.7 18 V BL LiHD**  
**Order no. 685140000**



- Combo Set 2.3.8 18 V BL LiHD**
- Cordless Drill / Screwdriver BS 18 LTX BL Q I
  - Cordless Combination Hammer KHA 18 LTX BL 24 Quick
  - 2 LiHD battery packs (18 V/5.5 Ah)
  - Charger ASC 30-36 V
  - Quick-change bit holders »Quick«
  - MetaLoc III
- Order no. 685120000**
- or with cordless impact drill SB 18 LTX BL Q I (instead of BS 18 LTX BL Q I)
- Combo Set 2.3.9 18 V BL LiHD**  
**Order no. 685121000**



- Combo Set 2.4.5 18 V BL LiHD**
- Cordless Drill / Screwdriver BS 18 LTX BL Q I
  - Cordless Angle Grinder WB 18 LTX BL 125 Quick
  - 2 LiHD battery packs (18 V/5.5 Ah)
  - Charger ASC 30-36 V
  - Quick-change bit holders »Quick«
  - MetaLoc IV
- Order no. 685094000**
- or with cordless impact drill SB 18 LT BL (instead of BS 18 LT BL)
- Combo Set 2.4.6 18 V BL LiHD**  
**Order no. 685095000**

## Large cordless angle grinder: 230 mm, 2,400 Watt, no cable.

The world's first 230 mm cordless angle grinder offers you ultimate freedom: Thanks to the revolutionary Metabo LiHD battery pack technology we are exploring new power dimensions which were previously reserved exclusively for powerful mains-powered machines. Completely independent from the power socket you can now cut and rough grind any time and everywhere with the cordless 36 volt machines. The WPB 36 LTX BL 230 Quick is as powerful as a 2,400 watt mains-powered machine and thanks to its encapsulated brushless motor with perfected dust protection, it's extremely robust and durable.

BRUSHLESS MOTOR

Extremely long service life even in dusty surroundings  
Unique encapsulated Metabo brushless motor with optimised dust protection

Max. battery pack flexibility  
Also available in 2x 18V



WPB 36 LTX BL 230

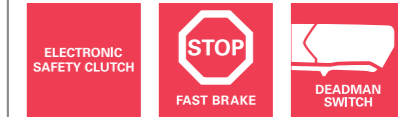

### Uncompromising user safety

- Reduced kickback if the disc stops unexpectedly thanks to electronic safety shutdown
- Safe stop by means of deadman's switch and brake system
- Safe handling when cutting thanks to rotating main handle

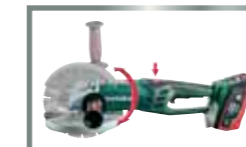

### Passes any endurance test in professional use!

You can do all this with a single battery charge:



Cutting through 11 crash barriers  
Material: Sheet steel



more than 75 roof tiles  
Material: Roofing Tiles



more than 5 cuts - concrete slabs  
Material: Concrete

01  
02  
03  
04  
05  
06  
07  
08  
09  
10  
11  
12  
13  
14  
15

36 V  
2x 18 V



Technical data	Cordless Angle Grinder WPB 36 LTX BL 230	Cordless Angle Grinder WPB 36-18 LTX BL 230
Type of battery pack	Li-Ion / LiHD	Li-Ion / LiHD
Battery pack voltage	36 V	18 V
Grinding wheel Ø	230 mm	230 mm
No-load speed	6,600 /min	6,600 /min
Spindle threads	M 14	M 14
Weight (including battery pack)	6.1 kg	6.9 kg

Scope of delivery	613101 <sup>1)</sup>	613102 <sup>1)</sup>
Order no.		
Guard	■	■
Inner support flange	■	■
Nut with two holes	■	■
Metabo VibraTech (MVT) side handle	■	■
Flat-pin spanners	■	■
2 LiHD battery packs (36 V/6.2 Ah)	■	■
4 LiHD battery packs (18 V/8.0 Ah)	■	■
»AIR COOLED« quick charger ASC Ultra	■	■
2 Quick chargers ASC Ultra »AIR COOLED«	■	■
Plastic carry case	■	■
MetaLoc case	■	■

<sup>1)</sup> also available in 120 V (North/Latin America)

- Product advantages**
- 100% compatibility with the 18 Volt class: powerful 36 Volt operation with two 18 Volt battery packs from Metabo
  - World's first large angle grinder (Ø 230 mm) with battery operation for powerful cutting and roughing independent from the mains power
  - Widest range of application thanks to extremely large cutting depth of 77 mm
  - Unique encapsulated Metabo brushless motor with optimum protection from dust provides quick work progress and the highest efficiency
  - Deadman's switch for high user safety
  - Fast brake system for highest user safety stops the disc within a matter of seconds after switching off
  - Tool-free adjustable guard; twist-proof
  - Rotating main handle: high safety and better handling when cutting
  - Metabo VibraTech (MVT) side handle for vibration damping to protect the user's health
  - Side handle can be mounted in three positions
  - Electronic safety shutdown: reduces kickback if the disc stops unexpectedly - for high user safety
  - Overload protection, soft start and restart protection
  - Battery packs with capacity display for checking the charge status

**System components**

Accessories → 130 | Battery packs → 72

36 V  
2x 18 V



Technical data	Cordless Combination Hammer KHA 36 LTX	Cordless Combination Hammer KHA 36-18 LTX 32
Type of battery pack	Li-Ion / LiHD	Li-Ion / LiHD
Battery pack voltage	36 V	18 V
Max. single-impact energy (EPTA)	3.1 J	3.1 J
Maximum impact rate	4,500 /min	4,500 /min
Drill-Ø concrete with hammer drills	32 mm	32 mm
Drill-Ø masonry with core bits	68 mm	68 mm
Drill Ø steel	13 mm	13 mm
Drill-Ø soft wood	30 mm	30 mm
No-load speed	0 - 1,100 /min	0 - 1,100 /min
Bit retainer	SDS-plus	SDS-plus
Weight (including battery pack)	4.9 kg	5.8 kg

Scope of delivery	600795 <sup>1)</sup>	600796
Order no.		
Hammer chuck for tools with SDS-plus shank end	■	■
Keyless chuck for tools with cylindrical shank	■	■
Metabo VibraTech (MVT) side handle	■	■
Drilling depth guide	■	■
4 Li-Power Battery packs (18 V/8.0 Ah)	■	■
2 Li-Power battery packs (36 V/5.2 Ah)	■	■
2 Quick chargers ASC Ultra »AIR COOLED«	■	■
»AIR COOLED« quick charger ASC Ultra	■	■
Plastic carry case	■	■
MetaLoc case	■	■

Equipment variants can be found in the Metabo price list and on the internet  
<sup>1)</sup> also available in 120 V (North/Latin America)

- Product advantages**
- 100% compatibility with the 18 Volt class: powerful 36 Volt operation with two 18 Volt battery packs from Metabo
  - Combination hammer with 3 functions: hammer drilling, drilling and chiselling
  - Metabo VibraTech (MVT): working, also continuously, in a low-fatigue manner whilst protecting the user's health
  - Ergonomic housing shape for chiselling tasks without side handle
  - Metabo Quick: fast, tool-free chuck for working with SDS-plus and straight shank drill bits
  - Variospeed (V) Electronics for working at customised speeds to suit various application materials
  - Metabo S-automatic safety clutch: mechanical decoupling of the drive for safe working should the drill stop unexpectedly
  - Battery packs with capacity display for checking the charge status

**System components**

Accessories → 289 | Battery packs → 72

36 V  
2x 18 V



NEW

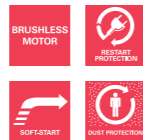

NEW

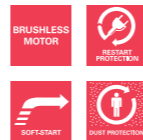

Technical data	Cordless Table Saw TS 36 LTX BL 254	Cordless Table Saw TS 36-18 LTX BL 254
Type of battery pack	Li-Ion / LiHD	Li-Ion / LiHD
Battery pack voltage	36 V	18 V
Max. support surface	970 x 995 mm	970 x 995 mm
Cutting height	0 - 87 mm	0 - 87 mm
Maximum cutting height 90/45°	87 mm/50 mm	87 mm/50 mm
Maximum cutting width at parallel guide/rip fence	630 mm	630 mm
Maximum material width at mitre fence	200 mm	200 mm
No-load speed	5,000 /min	5,000 /min
Max. cutting speed	66 m/s	66 m/s
Saw Blade	Ø 254 x 30 mm	Ø 254 x 30 mm
Saw blade swivel range	-1.5 - 46.5 °	-1.5 - 46.5 °
Weight (including battery pack)	34.5 kg	34.6 kg

Scope of delivery

Order no.	613024	613025
Carbide saw blade (40 teeth)	■	■
Stand	■	■
Rubber tyres	■	■
Parallel guide / Rip fence	■	■
Mitre fence	■	■
Table length extension	■	■
Table width extension	■	■
Dust cycles	■	■
Textile dust bag	■	■
2 LiHD battery packs (36 V/6.2 Ah)	■	■
4 LiHD battery packs (18 V/8.0 Ah)	■	■
»AIR COOLED« quick charger ASC Ultra	1	2
Fixation strap for MetaLoc	■	■
MetaLoc case	■	■

Equipment variants can be found in the Metabo price list and on the internet

Product advantages

- 100% compatibility with the 18 Volt class: powerful 36 Volt operation with two 18 Volt battery packs from Metabo
- Extremely light cordless table saw with trolley function for maximum mobility
- Powerful Metabo brushless motor for powerful sawing like with a mains-powered tool
- Integrated extraction with dust cyclone for low-dust working without vacuum cleaner
- Quick change between sawing at ground-level or when standing up thanks to integrated, folding stand
- Precisely adjustable parallel guide / rip fence with double clamping and quick fastening
- Splitting wedge can be lowered without tools for hidden cuts and transport
- MetaLoc case and attachments can be fixed at the housing for compact transport and storage

System components

Accessories → 378 | Battery packs → 72

36 V



Technical data	Cordless Hedge Trimmer AHS 36 V	Cordless Hedge Trimmer AHS 36-65 V
Type of battery pack	Li-Ion	Li-Ion
Battery pack voltage	36 V	36 V
Runtime per battery pack charge	85 min	85 min
Cutting thickness	18 mm	18 mm
Cutting strength	53 cm	63 cm
No of strokes (no load)	2,700 /min	2,700 /min
Weight (including battery pack)	3.9 kg	4.1 kg

Scope of delivery

Order no.	602177	602203
Li-Power battery pack (36 V/2.5 Ah)	■	■
2 Li-Power battery packs (36 V/2.5 Ah)	■	■
»AIR COOLED« quick charger ASC Ultra	■	■
Charger ASC 30-36 V »AIR COOLED«	■	■
Storage slipcase	■	■

Product advantages

- The lightest machines amongst professional hedge trimmers in the 36 V class
- Blades with special geometry generate less wear and thus deliver 200% longer service life
- Clean cut thanks to diamond-ground blade teeth on both sides at a 30° angle
- Lower safety blade for high safety at work
- Top cutting performance generated by double reduction gearing
- Pleasant to work with thanks to low-vibration running, perfect ergonomics and soft-grip handle
- Safety features include electronic blade quick stop (in 0.3 seconds)
- Trigger guard with twig feed protects user and gearing from kickbacks
- Battery packs with capacity display for checking the charge status

System components

Accessories → 575 | Battery packs → 72

01  
02  
03  
04  
05  
06  
07  
08  
09  
10  
11  
12  
13  
14  
15

Battery Packs

LiHD Battery Packs



LiHD slide-on battery packs

- LiHD battery packs for ultimate performance and extremely long application with minimal temperature generation
- Ultra-M technology: Intelligent battery management for long-lasting battery packs with a 3 year guarantee
- Patented »AIR COOLED« charging technology
- Permanent Electronic Single Cell Protection (ESCP) when charging, for particularly long life.
- Processor-controlled charge and discharge management
- Capacity display for permanent control of the fill level
- No memory effect
- Capacity display with almost no self-discharge

	Battery pack voltage	Capacity of battery pack	AIR COOLED	Order no.
<b>NEW</b>	18 V	4.0 Ah	■	625367000*
<b>NEW</b>	18 V	5.5 Ah	■	625368000*
<b>NEW</b>	18 V	8.0 Ah	■	625369000*
	36 V	6.2 Ah	■	625344000

Li-ion Battery Packs



Li-ion slide-on battery packs »AIR COOLED«

- Ultra-M technology: Intelligent battery management for long-lasting battery packs with a 3 year guarantee
- Patented »AIR COOLED« charging technology
- Permanent Electronic Single Cell Protection (ESCP) when charging, for particularly long life.
- Processor-controlled charge and discharge management
- Capacity display for permanent control of the fill level
- No memory effect
- Capacity display with almost no self-discharge

	Battery pack voltage	Capacity of battery pack	AIR COOLED	Order no.
	14.4 V	2.0 Ah	■	625595000*
	14.4 V	4.0 Ah	■	625590000*
	18 V	2.0 Ah	■	625596000*
	18 V	4.0 Ah	■	625591000*
	18 V	5.2 Ah	■	625592000*
	36 V	1.5 Ah	■	625453000*
	36 V	5.2 Ah	■	625529000*



Li-ion battery packs 10.8 V

- Ultra-M technology: Intelligent battery management for long-lasting battery packs with a 3 year guarantee
- Permanent Electronic Single Cell Protection (ESCP) when charging, for particularly long life.
- No memory effect
- Capacity display with almost no self-discharge
- Excellent environmental properties

	10.8 V	2.0 Ah		625438000*
	10.8 V	4.0 Ah		625585000*
	10.8 V	5.2 Ah		625597000*



Li-ion battery packs 7.2 V

- Ultra-M technology: Intelligent battery management for long-lasting battery packs with a 3 year guarantee
- Permanent Electronic Single Cell Protection (ESCP) when charging, for particularly long life.
- No memory effect
- Capacity display with almost no self-discharge
- Excellent environmental properties

	7.2 V	2.2 Ah		625487000*
--	-------	--------	--	------------

	Battery pack voltage	Capacity of battery pack	AIR COOLED	Order no.
	25.2 V	3.0 Ah	■	625437000*





Li-ion battery packs 25.2 V

- Ultra-M technology: Intelligent battery management for long-lasting battery packs with a 3 year guarantee
- Patented »AIR COOLED« charging technology
- Permanent Electronic Single Cell Protection (ESCP) when charging, for particularly long life.
- Processor-controlled charge and discharge management
- Capacity display for permanent control of the fill level
- No memory effect
- Capacity display with almost no self-discharge
- Excellent environmental properties









Chargers, Desktop Chargers

		Order no.
	<p><b>Charger ASC 30-36 V</b></p> <ul style="list-style-type: none"> <li>■ For charging all Li-Ion and LiHD slide-on battery packs (14.4 V - 36 V).</li> <li>■ Patented »AIR COOLED« charging technology</li> <li>■ Charging current 3.0 A</li> <li>■ Very low stand-by input power</li> <li>■ Processor-controlled charging management system</li> </ul> <p>Mains voltage: 230 - 240 V Mains frequency: 50 - 60 Hz</p>	627044000*
	<p><b>Desktop charger ASC multi 8</b></p> <ul style="list-style-type: none"> <li>■ Fast, parallel charging of up to eight Li-Ion and LiHD slide-on battery packs from 14.4 - 36 volts; no time loss when charging multiple batteries at once</li> <li>■ Patented »AIR COOLED« charging technology for all individual battery packs for fast, safe charging</li> <li>■ Robust aluminium housing with hook for space-saving wall mounting. With carry handle for mobile use</li> <li>■ With a lead (680 watts) for 8 full-power charging stations with process-controlled charging management for each individual battery bay</li> <li>■ Side on/off switch for the entire desktop charger</li> <li>■ Charge rate: each 3.0 A Charge time: approx. 30 minutes at 1.5 Ah; approx. 80 minutes at 4.0 Ah</li> <li>■ Space-saving and tidy solution, ideal for medium-sized and large industrial companies and large trade companies.</li> <li>■ Easy maintenance, requiring only annual BGVA3 test for lead cable, rather than 8 tests</li> </ul> <p>Mains voltage: 230 - 240 V Mains frequency: 50 - 60 Hz</p>	627291000
	<p><b>Quick charger ASC Ultra</b></p> <ul style="list-style-type: none"> <li>■ For charging all Li-Ion and LiHD slide-on battery packs (14.4 V - 36 V)</li> <li>■ Patented »AIR COOLED« charging technology</li> <li>■ Charging current 6.5 A</li> <li>■ Very low stand-by input power</li> <li>■ Processor-controlled charging management system</li> </ul> <p>Charge time approximately 30 minutes at 1.5 Ah; approximately 35 minutes at 4.0 Ah Mains voltage: 230 - 240 V Mains frequency: 50 - 60 Hz</p>	627265000*
	<p><b>ASS 15 Plus Quick Charger</b></p> <ul style="list-style-type: none"> <li>■ For charging Metabo NiCd battery packs of 24-25.2 V, as well as Li-ion battery packs of 24-25.2 V (Cordless combination hammers KHA 24, cordless magnetic core drills MAG 28 LTX 32)</li> <li>■ »AIR COOLED« function</li> <li>■ "Refresh" function for maintenance of batteries for NiCd battery packs</li> <li>■ Charging current 5 A</li> </ul> <p>"Refresh" function: with NiCd battery packs, the natural self-discharge can result in the cells in the battery pack having different charging levels. This means that the full battery pack capacity is no longer available for the application. If you notice such an effect, you can restore the full battery back capacity in the "Refresh" mode Mains voltage: 230 - 240 V Mains frequency: 50 - 60 Hz</p>	627283000*



















\* Self-service packaging

	Order no.
 <p><b>Charger LC 40</b>                      ■ For charging Li-ion battery packs 10.8 V                      ■ Charging current 2.3 A                      Mains voltage: 230 - 240 V                      Mains frequency: 50 - 60 Hz</p>	627064000*
 <p><b>Charger LC 60</b>                      ■ For charging Li-ion battery packs 7.2 V                      ■ Charging current 2.4 A                      Mains voltage: 230 - 240 V                      Mains frequency: 50 - 60 Hz</p>	627306000*
 <p><b>AC 30 Plus Charger</b>                      ■ For charging all old (with adapter 627075000) and new Metabo NiCd and NiMH battery packs of 4.8 V -18 V, as well as the new Li-Ion battery packs of 12 V-18 V                      ■ »AIR COOLED« function                      ■ Charging current 2.5 A                      Mains voltage: 230 - 240 V                      Mains frequency: 50 - 60 Hz</p>	627275000*
 <p><b>Charger C 60</b>                      ■ For charging NiCd battery packs 12 V/1.7 Ah (625472000)                      ■ Charging current 2.2 A                      Mains voltage: 230 - 240 V                      Mains frequency: 50 - 60 Hz</p>	627053000*
 <p><b>Charger 2 hours for Power Grip²/ PowerMaxx</b>                      ■ Especially for the Power Grip² and PowerMaxx (as spare)                      ■ Charging current 0.7 A                      Mains voltage: 230 - 240 V                      Mains frequency: 50 - 60 Hz</p>	627270000*

Basic Sets Battery Packs with Charger



	Order no.
<p><b>10.8 V</b></p>  <p><b>Basic set 10.8 V / 2 x 2.0 Ah</b>                      2 x battery pack 10.8 V/2.0 Ah                      Charger LC 40</p>	685066000
<p><b>10.8 V</b></p>  <p><b>Basic set 10.8 V / 1 x 2.0 Ah / 1 x 5.2 Ah</b>                      1 x battery pack 10.8 V/2.0 Ah                      1 x battery pack 10.8 V/5.2 Ah                      Charger LC 40</p>	685067000
<p><b>18 V</b></p>  <p><b>Basic set 2 x 3.0 Ah</b>                      2 x Li-Power battery pack 18 V/3.0 Ah                      Charger ASC 30-36 V</p>	685107000
<p><b>18 V</b></p>  <p><b>Basic set 3 x 4.0 Ah</b>                      3 x Li-Power battery pack 18 V/4.0 Ah                      Charger ASC 30-36 V</p>	685049000
<p><b>18 V</b></p>  <p><b>Basic set 2 x 4.0 Ah</b>                      2 x Li-Power battery pack 18 V/4.0 Ah                      Charger ASC 30-36 V</p>	685050000
<p><b>18 V</b></p>  <p><b>Basic set 3 x 5.2 Ah</b>                      3 x Li-Power battery pack 18 V/5.2 Ah                      Charger ASC 30-36 V</p>	685048000
<p><b>18 V</b></p>  <p><b>Basic set 2 x 5.2 Ah</b>                      2 x Li-Power battery pack 18 V/5.2 Ah                      Charger ASC 30-36 V</p>	685051000
<p><b>18 V</b></p>  <p><b>Basic set 3 x 5.2 Ah ASC Ultra</b>                      3 x Li-Power battery pack 18 V/5.2 Ah                      Charger ASC Ultra</p>	685061000

\* Self-service packaging







	Order no.
<p><b>18 V</b></p>  <p><b>Basic set 3 x 4.0 Ah + Metaloc</b>                      3 x Li-Power battery pack 18 V/4.0 Ah                      Charger ASC 30-36 V                      Metaloc II</p>	685063000
<p><b>18 V</b></p>  <p><b>Basic set 2 x 4.0 Ah + Metaloc</b>                      2 x Li-Power battery pack 18 V/4.0 Ah                      Charger ASC 30-36 V                      Metaloc II</p>	685064000
<p><b>18 V</b></p>  <p><b>Basic set 2 x 5.2 Ah + 4.0 Ah + Metaloc</b>                      2 x Li-Power battery pack 18 V/5.2 Ah + 18V/4.0 Ah                      Charger ASC 30-36 V                      Metaloc II</p>	685117000
<p><b>18 V</b></p>  <p><b>Basic set 2 x 5.2 Ah + Metaloc</b>                      2 x Li-Power battery pack 18 V/5.2 Ah                      Charger ASC 30-36 V                      Metaloc II</p>	685065000
<p><b>18 V</b></p>  <p><b>Basic set 3 x 5.2 Ah ASC Ultra + Metaloc</b>                      3 x Li-Power battery pack 18 V/5.2 Ah                      Charger ASC Ultra                      Metaloc II</p>	685068000
<p><b>18 V</b></p>  <p><b>Basic set 4 x 5.2 Ah + 2 x ASC Ultra + Metaloc</b>                      4 x battery pack 18 V/5.2 Ah                      2 x charger ASC Ultra                      Metaloc II</p>	685106000
<p><b>18 V</b></p>  <p><b>Basic set 3 x 5.2 Ah + Metaloc</b>                      3 x Li-Power battery pack 18 V/5.2 Ah                      Charger ASC 30-36 V                      Metaloc II</p>	685062000
<p><b>18 V</b></p>  <p><b>Basic set 2 x LiHD 5.5 Ah</b>                      2 x LiHD battery packs 18 V/5.5 Ah                      Charger ASC 30-36 V</p>	685122000
<p><b>18 V</b></p>  <p><b>Basic set 3 x LiHD 5.5 Ah</b>                      3 x LiHD battery pack 18 V/5.5 Ah                      Charger ASC 30-36 V</p>	685074000
<p><b>18 V</b></p>  <p><b>Basic set 2 x LiHD 5.5 Ah + Metaloc</b>                      2 x LiHD battery packs 18 V/5.5 Ah                      Quick charger ASC Ultra                      Metaloc II</p>	685077000
<p><b>18 V</b></p>  <p><b>Basic set 3 x LiHD 4.0 Ah + Metaloc</b>                      3 x LiHD battery pack 18 V/4.0 Ah                      Charger ASC 30-36 V                      Metaloc II</p>	685133000
<p><b>18 V</b></p>  <p><b>Basic set 3 x LiHD 4.0 Ah</b>                      3 x LiHD battery pack 18 V/4.0 Ah                      Charger ASC 30-36 V</p>	685132000
<p><b>18 V</b></p>  <p><b>Basic set 2 x LiHD 4.0 Ah + ASC Ultra + Metaloc</b>                      2 x LiHD battery pack 18 V/4.0 Ah                      Quick charger ASC Ultra                      Metaloc II</p>	685130000
<p><b>18 V</b></p>  <p><b>Basic set LiHD 1 x 4.0 + 1 x 5.5 Ah + Metaloc</b>                      1 x LiHD battery pack 18 V/4.0 Ah + 1 x LiHD battery pack 18 V/5.5 Ah                      Quick charger ASC 30-36V                      Metaloc II</p>	685136000
<p><b>18 V</b></p>  <p><b>Basic set 3 x LiHD 5.5 Ah + Metaloc</b>                      3 x LiHD battery pack 18 V/5.5 Ah                      Charger ASC 30-36 V                      Metaloc II</p>	685069000
<p><b>18 V</b></p>  <p><b>Basic set 2 x LiHD 8.0 Ah + ASC Ultra + Metaloc</b>                      2 x LiHD battery pack 18 V/8.0 Ah                      Charger ASC Ultra                      Metaloc II</p>	685131000
<p><b>18 V</b></p>  <p><b>Basic set 3 x LiHD 8.0 Ah + ASC Ultra + Metaloc</b>                      3 x LiHD battery pack 18 V/8.0 Ah                      Charger ASC Ultra                      Metaloc II</p>	685134000
<p><b>18 V</b></p>  <p><b>Basic set 4 x LiHD 8.0 Ah + 2 x ASC Ultra + Metaloc</b>                      4 x LiHD battery pack 18 V/8.0 Ah                      2 x charger ASC Ultra                      Metaloc II</p>	685135000
<p><b>36 V</b></p>  <p><b>Basic set 2 x 36V LiHD 6.2 Ah + ASC Ultra + Metaloc</b>                      2 x 36V LiHD battery pack 18 V/6.2 Ah                      Charger ASC Ultra                      Metaloc II</p>	685115000

Accessories for »Quick« Drills and Drills / Screwdrivers

Accessories for »Quick« Drills and Drills/Screwdrivers		Order no.
	<p><b>PowerX3 torque setting adapter</b></p> <ul style="list-style-type: none"> <li>The torque setting adapter enables the power of the tool (torque) to be tripled to handle tough jobs</li> <li>Suitable for all Metabo cordless drills/screwdrivers, cordless hammer drills and drills with Metabo »Quick«- quick change system in combination with 43 mm collet</li> <li>Standard equipment incl. bit (1 x TX 50) and adapter for adjusting the handle length</li> <li>Bit retainer with 1/2" male square and 1/4" (6.35 mm) female hexagon socket</li> </ul> <p>Attention: Use the PowerX3 in conjunction with the following tools only and using the stipulated length of the handle depending on the torque: all cordless drill/screwdrivers and LTX »Quick« hammer drills as well as BE 75 Quick drill: 640 mm handle length; BE 1300 Quick drill: 380 mm handle length.</p>	627256000
	<p><b>Quick-change geared chuck »Quick«</b></p> <ul style="list-style-type: none"> <li>Simple, fast and convenient chuck change thanks to the Metabo Quick change system</li> <li>Impact-proof version; suitable for clockwise and anti-clockwise rotation</li> <li>Clamping width: 1.5 - 13 mm</li> <li>Suitable for all Metabo »Quick« machines</li> </ul>	627238000*
	<p><b>Quick-change chuck Futuro Plus S 1 M, »Quick«</b></p> <ul style="list-style-type: none"> <li>Simple, fast and convenient chuck change thanks to the Metabo Quick change system</li> <li>Stable version with metal sleeve; 1 sleeve; impact-resistant version; suitable for clockwise and anti-clockwise rotation</li> <li>Clamping width: 1.5 - 13 mm</li> <li>Suitable for all Metabo »Quick« machines</li> </ul>	627240000*
	<p><b>Quick-change chuck Futuro Plus H 1 R+L, »Quick«</b></p> <ul style="list-style-type: none"> <li>Simple, fast and convenient chuck change thanks to the Metabo Quick change system</li> <li>Version with metal sleeve; 1 sleeve; impact-resistant model; suitable for clockwise and anti-clockwise rotation</li> <li>Clamping width: 1.0 - 10 mm</li> <li>Suitable for all Metabo »Quick« machines</li> </ul>	627259000*
	<p><b>Quick-change chuck Futuro Plus H 1 R+L, »Quick«</b></p> <ul style="list-style-type: none"> <li>Simple, fast and convenient chuck change thanks to the Metabo Quick change system</li> <li>Compact version with plastic sleeve; 1 sleeve; impact-resistant model; suitable for clockwise and anti-clockwise rotation</li> <li>Clamping width: 1.5 - 13 mm</li> <li>Suitable for all Metabo »Quick« machines</li> </ul>	636608000*
	<p><b>Quick change threaded chuck M4 - M6</b></p> <ul style="list-style-type: none"> <li>Keyless chuck for inserting taps with square and cylindrical shanks</li> <li>Simple, fast and convenient chuck change thanks to the Metabo Quick change system</li> <li>Version with metal sleeve; 1 sleeve; impact-resistant model; suitable for clockwise and anti-clockwise rotation</li> <li>Clamping width: 1.5-8 mm; drill chuck with square holder 3.5 mm for M4 and 5.0 mm for M6</li> <li>Suitable for all Metabo »Quick« machines</li> </ul>	627235000*
	<p><b>Quick change threaded chuck M8 - M12</b></p> <ul style="list-style-type: none"> <li>Keyless chuck for inserting taps with square and cylindrical shanks</li> <li>Simple, fast and convenient chuck change thanks to the Metabo Quick change system</li> <li>Version with metal sleeve; 1 sleeve; impact-resistant model; suitable for clockwise and anti-clockwise rotation</li> <li>Clamping width: 1.5-13 mm; chuck with square holder 6.0 mm for M8 and 8.1 mm for M10 and M12</li> <li>Suitable for all Metabo »Quick« machines</li> </ul>	627237000*
	<p><b>Quick-change bit holder »Quick«</b></p> <ul style="list-style-type: none"> <li>Easy, fast and comfortable change of the bit holder thanks to Metabo quick change system »Quick«</li> <li>Bit holder suitable for bits with 1/4" external hexagonal drive according to DIN 3126- C 6.3 and E 6.3</li> <li>Suitable for all Metabo »Quick« machines</li> </ul>	627241000*
	<p><b>Quick-change angle adapter »Quick«</b></p> <ul style="list-style-type: none"> <li>Quick and comfortable fixing of angle adapter without tools</li> <li>Quick spindle for fixing the quick change angle adapter 627240000 and bit holder 627241000</li> <li>Magnetic bit holder with 1/4" (6.35 mm) hexagonal shank</li> <li>Suitable for forward and reverse rotation</li> <li>Suitable for cordless machines up to a maximum of 110 Nm</li> <li>Suitable for all Metabo »Quick« machines with collet Ø 43 mm</li> </ul>	627242000*



	<p><b>Quick-change angle adapter »Quick«</b></p> <ul style="list-style-type: none"> <li>Quick and comfortable fixing of angle adapter without tools</li> <li>Quick spindle for fixing the quick change angle adapter 627240000 and bit holder 627241000</li> <li>Magnetic bit holder with 1/4" (6.35 mm) hexagonal shank</li> <li>Suitable for forward and reverse rotation</li> <li>Suitable for cordless machines up to a maximum of 100 Nm</li> <li>Suitable for all Metabo LT »Quick« models (from year of construction 02/2013)</li> </ul>	627077000*
	<p><b>Quick-change angle adapter »Quick«</b></p> <ul style="list-style-type: none"> <li>For drilling and fixing screws in hard to reach places</li> <li>Magnetic bit holder with 1/4" (6.35 mm) hexagonal shank</li> <li>Gears made of special steel</li> <li>Suitable for forward and reverse rotation; up to max. 28 Nm</li> <li>Especially for PowerMaxx BS Quick and BS 18 Quick</li> </ul>	627261000*

Accessories for PowerGrip / PowerMaxx

		Order no.
	<p><b>Screw-type angle attachment for PowerMaxx</b></p> <ul style="list-style-type: none"> <li>Magnetic bit holder with 1/4" (6.35 mm) hexagonal shank</li> <li>Gears made of special steel</li> <li>For forward and reverse rotation; suitable for PowerMaxx to a maximum of 16 Nm</li> </ul> <p>For fixing screws more easily in difficult to reach locations Specially for PowerMaxx (7.2V)</p>	630650000*
	<p><b>Geared Chucks</b></p> <ul style="list-style-type: none"> <li>With hexagonal shank 1/4" (6.35 mm), bit retaining bush and chuck key</li> </ul> <p>Clamping width 0.5 - 6.5 mm</p>	635100000*
	<p><b>Adapter</b></p> <ul style="list-style-type: none"> <li>Adapter with hexagonal shank KW 6.3 and 1/2"-20 UNF</li> <li>For inserting a chuck (e.g. 636623000) in the screw-type angle attachment for the PowerMaxx 630650000</li> </ul> <p>For use in a chuck in combination with the screw-type angle attachment. Thus allowing the PowerMaxx Li to also be used as an angle drill.</p>	625226000*
	<p><b>Screw-type angle attachment for PowerMaxx 12</b></p> <ul style="list-style-type: none"> <li>Magnetic bit holder with 1/4" (6.35 mm) hexagonal shank</li> <li>Gears made of special steel</li> <li>For forward and reverse rotation; suitable for PowerMaxx to max. 28 Nm</li> </ul> <p>For fixing screws more easily in difficult to reach locations Especially for PowerMaxx 12/ BS (type no. 600090; 600091; 600092)</p>	630649000*
	<p><b>Keyless chuck Futuro Plus H1, R+L, 1-10 mm, 1/2" UNF</b></p> <ul style="list-style-type: none"> <li>Special design for drills with spindle stop</li> <li>Plastic sleeve</li> <li>Single sleeve without supporting ring</li> </ul> <p>Clamping width: 1 - 10 mm Female thread: 1/2" - 20 UNF External-Ø: 40 mm Length (closed): 49 mm Weight: 0.15 kg</p>	636219000*
	<p><b>Futuro Plus H1 M keyless chuck</b></p> <ul style="list-style-type: none"> <li>Special design for drills with spindle stop</li> <li>Single sleeve (without supporting ring)</li> </ul> <p>Clamping width: 0.8 - 6.5 mm Female thread: 1/2" - 20 UNF External-Ø: 34 mm Length (closed): 57 mm Weight: 0.14 kg</p>	636623000*

\* Self-service packaging

### Accessories for Cordless Combination Hammer KHA 18 LTX BL 24 Quick

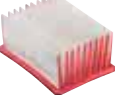
		Order no.
	<b>ISA 18 LTX 24 Integrated Dust Extraction</b> <ul style="list-style-type: none"> <li>Extremely light and compact dust extraction for dust-free drilling in concrete, stone and masonry</li> <li>Simple, tool-free installation to the cordless hammer KHA 18 LTX BL 24 Quick</li> <li>Ideal for working overhead or in areas sensible to dust</li> <li>Health-friendly working with HEPA filter for smallest dust particles</li> <li>Precise setting for different drilling depths and drill bit lengths</li> <li>Tool-free replaceable suction head with low-wear brushes</li> <li>3 Second delay to extract the remaining dust from the drill hole</li> <li>Transparent collection container can be emptied easily, e.g. for 160 bores Ø 6 / 40 mm</li> <li>100% Drilling performance with active dust extraction thanks to being driven by own motor</li> </ul> Drill bit-Ø: 5 - 16 mm Max. drill bit length: 160 mm Rated input power: 65 W Weight: 1.1 kg Scope of delivery: replacement extraction head	631341890
	<b>ISA 18 LTX 24 integrated dust extraction in the Metaloc</b>	631341840
	<b>Extraction head set, 2 pieces for ISA 18 LTX</b> <ul style="list-style-type: none"> <li>Original suction head for highest suction performance with the ISA 18 LTX</li> </ul>	623767000
	<b>HEPA filter for ISA 18 LTX</b> <ul style="list-style-type: none"> <li>HEPA filter for highest health protection</li> <li>Keeps back 99.995% of fine dusts larger than 0.3 µm</li> </ul>	623768000

### Accessory for Cordless Caulking Guns



Cartridge tube		Order no.
	<b>Cartridge tube</b> <ul style="list-style-type: none"> <li>Cartridge tube 400 ml incl. rack and push plate for standard foil bags and cartridges</li> </ul>	630148000*

### Accessory for Cordless Blind Rivet Gun

Chuck jaws		Order no.
	<b>Chuck jaws</b> <ul style="list-style-type: none"> <li>Especially hardened chuck jaws, therefore low-wear and long service life</li> </ul>	627355000*

**NEW**

### Accessories for the Cordless Site Light

Tripods		Order no.
	<b>Tripod for cordless site light</b> <ul style="list-style-type: none"> <li>Telescopic legs with quick locking and additional central telescopic extension</li> <li>Stable support thanks to non-slip rubberised feet, tripod feet secured together with chains</li> <li>Easy to transport thanks to carry strap and bag</li> </ul> Working height: 85 cm – 173 cm Connecting thread: 5/8" Weight: 5 kg	623729000
	<b>Construction tripod</b> <ul style="list-style-type: none"> <li>Multi-purpose aluminium construction tripod</li> <li>Ideal for working on the cutting check line</li> <li>Telescopic legs with quick locking and anti-splay stop</li> <li>Geared column with metric gauge for fine adjustment of height</li> <li>Removable tripod head for convenient setup</li> <li>Good stability thanks to non-slip rubber feet</li> <li>Adapter for connecting different devices</li> <li>Easy to transport thanks to carry strap and bag</li> </ul> Working height: 74 cm – 192 cm Working height including extension piece: up to 265 cm Connecting thread: 1/4"+ 5/8" Weight: 5 kg	628791000
Protective screen		Order no.
	<b>Protective screen, matt</b> <ul style="list-style-type: none"> <li>Replacement protective screen for cordless site light</li> <li>Suitable for cordless site light with order no. 602111010 and 602122850</li> </ul>	623569000*

\* Self-service packaging



# M+ System: Machine and accessories perfectly synchronised for maximum performance.

Even during the development phase at Metabo, machines and accessories are optimally adjusted and tested to complement one another. Your added benefit: Maximum performance when cutting, roughing or polishing thanks to Metabo + System effect.



## Angle Grinders Angle Polishers

## Flat-head Angle Grinders: Problem solvers in acute angles: down to 39°!

Do you need to grind fillet welds in tight angles, or clean deep root seams? No need for time-consuming work with wire brushes or designing modified tools. The flat head angle grinders of up to 1,550 Watts always help you out when it gets tight. They work quickly and safely in hard-to-reach and narrow places at angles down to 39°. This is made possible by the extremely flat gear head.

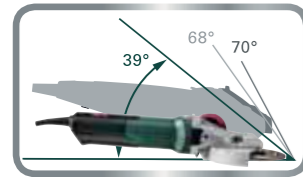

Fast and safe in angles as tight as 39° thanks to its extremely flat gear head

MARATHON MOTOR

**Metabo Marathon-motor for a longer service life and added power**

- Patented dust protection
- Up to 20% more overload capacity
- Up to 50 % more torque



WEPPBF 15-150 Quick



**High user safety**

- Patented, mechanical disc brake
- Ergonomic paddle switch with dead man function: disc stops when released and within two seconds following loss of power



Disc change is fast and requires no tools with quick-locking nut

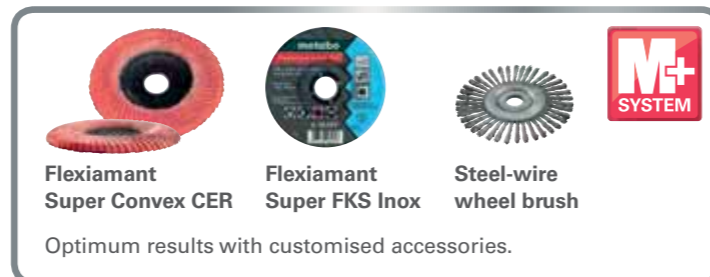

Flexiamant Super Convex CER    Flexiamant Super FKS Inox    Steel-wire wheel brush

Optimum results with customised accessories.

18 V  
Ø 125 mm



### Technical data

### Cordless Flat-head Angle Grinder WF 18 LTX 125 Quick

Type of battery pack	Li-Ion / LiHD
Battery pack voltage	18 V
Minimum accessible angle	43 °
Grinding wheel Ø	125 mm
No-load speed	8,000 /min
Spindle threads	M 14
Weight (including battery pack)	2.4 kg

### Scope of delivery

Order no.	601306
1 flap disc Flexiamant Super Convex (125 mm; P60)	■
Guard	■
Inner support flange	■
Quick-locking nut	■
Side handle	■
Dust protection filter	■
2 Li-Power battery packs (18 V/5.2 Ah)	■
Charger ASC 30-36 V »AIR COOLED«	■
Plastic carry case	■

Equipment variants can be found in the Metabo price list and on the internet

### Product advantages

- Extremely flat gear head permits working within acute angles down to 43°
- Compact design for quick removal of welding slag, rust or paint in confined spaces e.g. frame constructions
- Low-fatigue working even on weld seams in difficult to access places thanks to slim handle
- Robust motor for long service life
- Metabo Quick for tool-free disc change by means of a quick-locking nut
- Tool-free adjustable guard; twist-proof
- Battery pack can be swivelled for better access in hard to reach places
- Detachable dust protection filter protects motor from coarse particles
- Overload protection: protects the motor from overheating
- Electronic soft start for smooth start-up
- Restart protection: prevents unintentional start-up after power supply interruption
- Battery packs with capacity display for checking the charge status

### The flat-head angle grinder solves issues in tight spaces



... more quickly than die grinders



... more easily than with wire brushes



... more safely than modified tools

### System components

Accessories → 87

Battery packs → 72

Ø 125 mm



Technical data

Flat-head Angle Grinder  
WEF 9-125 Quick

Flat-head Angle Grinder  
WEPF 9-125 Quick

Minimum accessible angle	43 °	43 °
Grinding wheel Ø	125 mm	125 mm
Rated input power	910 W	910 W
Output power	430 W	430 W
No-load speed	10,000 /min	10,000 /min
Revolutions at rated load	8,200 /min	8,200 /min
Torque	2 Nm	2 Nm
Spindle threads	M 14	M 14
Weight (without mains cable)	2.1 kg	2.1 kg
Cable length	4 m	4 m

Scope of delivery

Order no.	613060 <sup>1) 2)</sup>	613069 <sup>1)</sup>
Guard	■	■
Inner support flange	■	■
Quick-locking nut	■	■
Side handle	■	■
5 Flap discs Flexiamant Super Convex (125 mm; P60)	■	■

<sup>1)</sup> also available in 120 V (North/Latin America)

<sup>2)</sup> also available in 110 V (UK)

Product advantages

- Paddle switch with dead man function: safe to operate due to an ergonomically integrated non-slip switch
- Most compact flat-head angle grinder for working at acute angles down to 43°
- Particularly developed for the removal of weld slag, rust or paint in narrow frame constructions and for working in tight spaces
- Metabo Marathon-motor with patented dust protection for long service life
- Constamatic (C) Full-wave Electronics: fast work progress by means of almost constant speed under load
- Metabo Quick for tool-free disc change by means of a quick-locking nut
- Tool-free adjustable guard; twist-proof
- Electronic safety shutdown: reduces kickback if the disc stops unexpectedly - for high user safety
- Electronic overload protection, soft start and restart protection
- Auto-stop carbon brushes to protect the motor

System components

Accessories → 87

Ø 125 mm

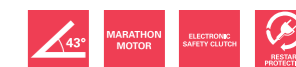

Technical data

Flat-head Angle Grinder  
WEVF 10-125 Quick Inox

Flat-head Angle Grinder  
WEF 15-125 Quick

Minimum accessible angle	43 °	43 °
Grinding wheel Ø	125 mm	125 mm
Rated input power	1,000 W	1,550 W
Output power	590 W	940 W
No-load speed	2,000 - 7,600 /min	11,000 /min
Revolutions at rated load	6,300 /min	11,000 /min
Torque	3.5 Nm	3.5 Nm
Spindle threads	M 14	M 14
Weight (without mains cable)	2.3 kg	2.7 kg
Cable length	4 m	4 m

Scope of delivery

Order no.	613080 <sup>1)</sup>	613082
Guard	■	■
Inner support flange	■	■
Quick-locking nut	■	■
Side handle	■	■
Metabo VibraTech (MVT) side handle		■
1 flap disc Flexiamant Super Convex (125 mm; P60)	■	■
1 roughing disc Flexiamant Super FKS 60 (125x4 mm; P60)		■

<sup>1)</sup> also available in 120 V (North/Latin America)

Product advantages

- The most easy-to-handle flat-head angle grinder with speed regulation for perfect processing of stainless steel e.g. railings and hand rails
- Thumbwheel controlled Vario-Constamatic (VC)-Full wave electronics ideal for working on materials requiring customised speeds, and at speeds which remain almost constant under load
- Powerful flat-head angle grinder for working quickly in acute angles down to 43°
- Tacho Constamatic (TC) Full-wave Electronics: fast work progress by means of constant speed under load
- Metabo VibraTech (MVT) side handle for vibration damping to protect the user's health
- Particularly developed for the removal of weld slag, rust or paint in narrow frame constructions and for working in tight spaces
- Longer service life, more power: the Metabo Marathon-motor with patented dust protection, up to 20% more overload capacity and 50% more torque
- Metabo Quick for tool-free disc change by means of a quick-locking nut
- Tool-free adjustable guard; twist-proof
- Electronic safety shutdown: reduces kickback if the disc stops unexpectedly - for high user safety
- Electronic overload protection, soft start and restart protection
- Gear housing can be unscrewed, rotated in 90° steps and remounted for left-handed operation or cutting
- Auto-stop carbon brushes to protect the motor

System components

Accessories → 87

Ø 150 mm



Technical data

Flat-head Angle Grinder  
WEF 15-150 Quick

Minimum accessible angle	39 °
Grinding wheel Ø	150 mm
Rated input power	1,550 W
Output power	940 W
No-load speed	9,600 /min
Revolutions at rated load	9,600 /min
Torque	3.9 Nm
Spindle threads	M 14
Weight (without mains cable)	2.7 kg
Cable length	4 m

Flat-head Angle Grinder  
WEPBF 15-150 Quick

Minimum accessible angle	39 °
Grinding wheel Ø	150 mm
Rated input power	1,550 W
Output power	940 W
No-load speed	9,600 /min
Revolutions at rated load	9,600 /min
Torque	3.9 Nm
Spindle threads	M 14
Weight (without mains cable)	2.9 kg
Cable length	4 m

Scope of delivery

Order no.	613083 <sup>1)</sup>	613085 <sup>1) 2)</sup>
Guard	■	■
Inner support flange	■	■
Quick-locking nut	■	■
Metabo VibraTech (MVT) side handle	■	■
1 flap disc Flexiamant Super Convex (150 mm; P60)	■	■
1 roughing disc Flexiamant Super FKS 60 (150x4 mm; P60)	■	■

<sup>1)</sup> also available in 120 V (North/Latin America)

<sup>2)</sup> also available in 110 V (UK)

Product advantages

- Paddle switch with dead man function: safe to operate due to an ergonomically integrated non-slip switch
- Fastest brake system for highest user safety: patented, mechanical disc brake stops the disc within 2 seconds after switching off, even in the event of a power cut
- Powerful flat-head angle grinder for working quickly in particularly acute angles down to 39°
- Particularly developed for the removal of weld slag, rust or paint in narrow frame constructions and for working in tight spaces
- Longer service life, more power: the Metabo Marathon-motor with patented dust protection, up to 20% more overload capacity and 50% more torque
- Tacho Constamatic (TC) Full-wave Electronics: fast work progress by means of constant speed under load
- Metabo Quick for tool-free disc change by means of a quick-locking nut
- Tool-free adjustable guard; twist-proof
- Metabo VibraTech (MVT) side handle for vibration damping to protect the user's health
- Electronic safety shutdown: reduces kickback if the disc stops unexpectedly - for high user safety
- Electronic overload protection, soft start and restart protection
- Gear housing can be unscrewed, rotated in 90° steps and remounted for left-handed operation or cutting
- Auto-stop carbon brushes to protect the motor

System components

Accessories → 87

Grinding discs









Quality class A46-P »Flexiamant Super FKS« Inox

- Special grinding disc for processing fillet welds in stainless steel and steel, thanks to a high finish quality. Other application examples: Processing of weld seams, deburring, grinding of corners and edges
- Particularly suited for front facing working with the Metabo flat-head angle grinders
- Clean cut with high material removal ensures excellent cutting output
- Different grain levels can be selected - additional fine grinding can consequently be omitted
- The grinding disc has a sectioned rim, therefore best-suited for the individual processing of the material
- Suitable for rust and acid resistant steels (V2A, Nirosta, INOX), highly solid, high-alloy steels, hardened steels, construction steels, grey cast iron
- Low in iron, sulphur and chlorine (Fe + S + Cl ≤ 0.1 %)/hardness: medium
- Maximum working speed 80 m/s

Quality class	Diameter x thickness x bore mm	Version	Maximum speed /min	Sales unit / packing unit	Order no.
A 46 P / 40	125 x 4 x 22.23	—	12,200	1/10	616197000
A 46 P / 60	125 x 4 x 22.23	—	12,200	1/10	616198000
A 46 P / 40	150 x 4 x 22.23	—	10,200	1/10	616199000
A 46 P / 60	150 x 4 x 22.23	—	10,200	1/10	616200000

Flap discs



	Diameter x bore mm	Grit	Version	Maximum speed /min	Sales unit / packing unit	Order no.
 <p><b>Quality class zirconia alumina »Flexiamant Convex«</b></p> <ul style="list-style-type: none"> <li>■ Specially shaped flap disc with lamellae that are rounded off towards the outer edges.</li> <li>■ Grinding media: Zirconia alumina</li> <li>■ Thanks to the special design it is particularly suited for processing fillet welds; making faster and more efficient processing possible; also suitable for surface grinding</li> <li>■ High material removal with very high tool life thanks to the use of zirconia alumina</li> <li>■ Suitable for processing stainless steel and steel</li> <li>■ Uniform grinding result, comfortable grinding with only low vibration</li> <li>■ Maximum working speed 80 m/s</li> </ul>	125 x 22.23	P 40	—	12,200	1/10	626462000
	125 x 22.23	P 60	—	12,200	1/10	626463000
	125 x 22.23	P 80	—	12,200	1/10	626464000
	150 x 22.23	P 40	—	10,200	1/10	626490000
	150 x 22.23	P 60	—	10,200	1/10	626491000
	150 x 22.23	P 80	—	10,200	1/10	626492000
 <p><b>Quality class ceramic »Flexiamant Super Convex«</b></p> <ul style="list-style-type: none"> <li>■ Specially shaped flap disc with lamellae that are rounded off towards the outer edges.</li> <li>■ Thanks to the special design it is particularly suited for processing fillet welds; making faster and more efficient processing possible; also suitable for surface grinding</li> <li>■ Very high material removal with very high tool life thanks to the use of ceramic grain.</li> <li>■ Cool cut for materials with poor thermal conduction</li> <li>■ For grinding of steel and stainless steel. Ideal for extreme grinding jobs like processing high-alloy steels, titanium alloys, nickel-based alloys as well as chromium and chromium-nickel steels, brass and bronze thanks to high load capacity.</li> <li>■ Uniform grinding result, comfortable grinding with only low vibration</li> <li>■ Maximum working speed 80 m/s</li> </ul>	125 x 22.23	P 60	—	12,200	1/10	626460000
	125 x 22.23	P 80	—	12,200	1/10	626461000
	150 x 22.23	P 60	—	10,200	1/10	626488000
	150 x 22.23	P 80	—	10,200	1/10	626489000

Flap wheels							
Diameter mm	Thickness mm	Female thread	Grit	Version	Maximum speed /min	Sales unit / packing unit	Order no.
 <p><b>Quality class ceramic »Flexiamant Super«</b></p> <ul style="list-style-type: none"> <li>Flap wheel with straight profiled lamellae, particularly suited for processing fillet welds. The profiled lamellae, arranged radially in the shape of a fan, adapt exceptionally well to the contours of the work piece. Ideally suited for an even and smooth weld seam. Thanks to the offset shape it can also be used at hard to reach places.</li> <li>High material removal with high tool life thanks to the use of ceramic grain.</li> <li>Excellent results for surface and edge grinding of steel and stainless steel. Ideal for extreme grinding jobs like processing high-alloy steels, titanium alloys, nickel-based alloys as well as chromium and chromium-nickel steels, brass and bronze thanks to high load capacity.</li> <li>Cool cut for materials with poor thermal conduction</li> <li>Maximum speed: 10,000 rpm</li> </ul>							
125	8	M 14	P 40		10,000	1/5	626470000
125	8	M 14	P 60		10,000	1/5	626471000
125	8	5/8 "	P 40		10,000	1/5	626486000
125	8	5/8 "	P 60		10,000	1/5	626487000



Fleece compact grinding discs »Unitized« - VKS-ZK			
 <ul style="list-style-type: none"> <li>Several layers of pressed fleece material, soaked with resin-bonded abrasive grain (zirconia alumina)</li> <li>The addition of abrasive grain covers a range of applications from deburring to soft and flexible finishing jobs. It is suited for deburring, smoothing of weld seams, precise cleaning and finishing of surfaces.</li> <li>For alloy and high-alloy steels, coloured and light metals, chrome and nickel steels, titanium, steels</li> <li>Profiling of the grinding media possible for precise working. Very low roughing of the processed material.</li> <li>Bore 22.23 mm (for angle grinder)</li> <li>Max. 10,000 rpm; recommended speed: 3,000 rpm</li> </ul>			
Diameter x thickness x bore mm	Grit	Sales unit / packing unit	Order no.
125 x 6 x 22.23	Coarse	1/5	626482000
125 x 6 x 22.23	medium	1/5	626483000



Steel-wire wheel brushes, twisted steel, pipeline					
 <ul style="list-style-type: none"> <li>Specially developed for the professional processing of U and V-weld seams in pipeline construction, as well as for root weld seam preparation</li> <li>Edging type: twisted steel wire</li> <li>Thickness of plait: 6.0 mm</li> </ul>					
Diameter mm	Bore Ø	Wire thickness	Maximum speed /min	Sales unit / packing unit	Order no.
125	22.23	0.50 mm	12,500	1/1	626815000*
150	22.25	0.50 mm	10,000	1/1	626816000*

Cutting blade guards		Order no.
 <p><b>Cutting blade guard 125 mm</b> For working with cutting discs, diameter: 125 mm diameter, suitable for the flat-head angle grinders WEF 9-125 / WF 18 LTX 125, WEPF 9-125 Quick / WPF 18 LTX 125 Grinding disc Ø: 125 mm</p>	630355000	

 <p><b>Cutting blade guard 125 mm</b> For working with cutting discs, diameter: 125 mm, suitable for the flat-head angle grinder WEF 15-125 Quick, WEVF 10-125 Quick, WEVF 10-125 Quick Inox Grinding disc Ø: 125 mm</p>	630372000
 <p><b>Cutting blade guard 150 mm</b> For working with cutting discs, diameter: 150 mm, suitable for the flat-head angle grinder WEF 15-150 Quick, WEPF 15-150 Quick, WEPBF 15-150 Quick Grinding disc Ø: 150 mm</p>	630378000

Dust protection filters	
<ul style="list-style-type: none"> <li>Filter against coarse particles or chips for longer service life of the machine when working e.g. with ceramic fibre, roughing or cutting discs or polishing with lambswool</li> <li>Easy and fast cleaning thanks to exterior metal grid without disturbing connecting ribs</li> <li>Tool-free assembly and disassembly</li> </ul>	

 <p><b>Dust protection filter for all angle grinders W...12..., WE...15..., WE...17... standard (not paddle, not RT)</b></p>	630709000*
 <p><b>Dust protection filter for all angle grinders WP...12..., WEP...15..., WEP...17... with paddle switch</b></p>	630792000*

Multi-position handle	
 <p><b>Multi-positioning for side handle</b></p> <ul style="list-style-type: none"> <li>The 180° handle permits variable individual adjustment of the side handle position for ergonomic, low-fatigue working e.g. for cutting jobs or for left-handed users</li> <li>The side handle can be adjusted without tools for changing working positions</li> <li>The robust hexagon shape permits folding the side handle to the rear for safe, two-handed operation in confined spaces</li> <li>Suitable for W..9-1..; except: WEF 9-125 WEV 10-125; W..12-1..; WE15-1..; WE..17-1..; W..8-1..; WE9-125; W..11-1..; WEQ 1400-125; WE14-1..; WEVF 10-1..; WE..F 15-1..; WE..19-180..</li> <li>Not suitable for: WP 1200-125 RT, WEV 1500-125 RT, WE 1500-125 RT, WE 1500-150 RT</li> </ul>	627362000
	

 <p><b>Front handle WS</b></p> <ul style="list-style-type: none"> <li>Front handle with ideal ergonomics, e.g. for surface grinding with fibre discs, light polishing work with diamond cup wheels etc.</li> <li>Suitable for Metabo angle grinders W..9..; WE 10..; W..12..; WE 15..; WE 17..</li> <li>Not suitable for: WP 1200-125 RT, WEV 1500-125 RT, WE 1500-125 RT, WE 1500-150 RT</li> </ul>	623262000
-------------------------------------------------------------------------------------------------------------------------------------------------------------------------------------------------------------------------------------------------------------------------------------------------------------------------------------------------------------------------------------------------------------------------------------------------------------------------------------------	-----------

01  
02  
03  
04  
05  
06  
07  
08  
09  
10  
11  
12  
13  
14  
15

# The brushless, cordless compact angle grinder: Powerful and long-lasting.

The cordless angle grinders from Metabo impress with excellent cordless technology combined with impressive performance. The interaction of enclosed brushless motor and the new LiHD battery pack technology make the new cordless compact angle grinder the strongest and most enduring machine of its kind.

Smallest handle circumference of only 165 mm for low-fatigue working and safe ergonomic fit

Unique enclosed Metabo brushless motor with optional dust protection for quick work progress and highest efficiency

**BRUSHLESS MOTOR**

**ELECTRONIC SAFETY CLUTCH**

Electronic safety shutdown reduces kickback if the disc stops unexpectedly - for high user safety.

**FAST BRAKE**

Fastest brake system with safety spindle for highest user protection stops the disc in a matter of seconds after switching off.



Rotating battery pack allows you to get into tight spaces  
Permits comfortable and practical working for a range of applications and especially in hard to reach places.

WB 18 LTX BL 180

18 V  
Ø 115 mm  
Ø 125 mm



**Technical data**

**Cordless Angle Grinder W 18 LTX 115 Quick**

**Cordless Angle Grinder W 18 LTX 125 Quick**

Type of battery pack	Li-Ion / LiHD	Li-Ion / LiHD
Battery pack voltage	18 V	18 V
Grinding wheel Ø	115 mm	125 mm
No-load speed	8,000 /min	8,000 /min
Spindle threads	M 14	M 14
Weight (including battery pack)	2.4 kg	2.4 kg

**Scope of delivery**

Order no.	602170	602174
Guard	■	■
Inner support flange	■	■
Quick-locking nut	■	■
Side handle	■	■
Dust protection filter	■	■
2 Li-Power battery packs (18 V/5.2 Ah)		■
Charger ASC 30-36 V »AIR COOLED«		■
Plastic carry case		■
MetaLoc case insert	■	
without battery pack, without charger	■	

**Product advantages**

- Slim design for prolonged comfort when working overhead or in areas with limited space
- Metabo Quick for tool-free disc change by means of a quick-locking nut
- Tool-free adjustable guard; twist-proof
- Battery pack can be swivelled for better access in hard to reach places
- Overload protection: protects the motor from overheating
- Electronic soft start for smooth start-up
- Restart protection: prevents unintentional start-up after power supply interruption
- Detachable dust protection filter protects motor from coarse particles
- Battery packs with capacity display for checking the charge status

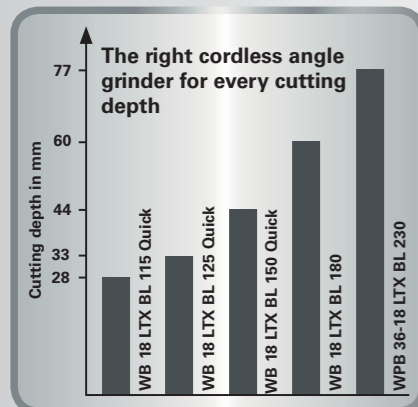

With a single battery pack charge: Separate 40 roof tiles  
WB 18 LTX 180 with LiHD 8.0 Ah



With a single battery pack charge: 28 cuts in steel tube (Ø 57 x 2.9 mm)  
WB 18 LTX 180 with LiHD 8.0 Ah

**System components**

Accessories → 130

Battery packs → 72

01  
02  
03  
04  
05  
06  
07  
08  
09  
10  
11  
12  
13  
14  
15

18 V  
Ø 125 mm



Technical data	Cordless Angle Grinder W 18 LTX 125 Quick Inox	Cordless Angle Grinder WP 18 LTX 125 Quick
Type of battery pack	Li-Ion / LiHD	Li-Ion / LiHD
Battery pack voltage	18 V	18 V
Grinding wheel Ø	125 mm	125 mm
No-load speed	5,000 /min	8,000 /min
Spindle threads	M 14	M 14
Weight (including battery pack)	2.4 kg	2.4 kg

Scope of delivery	600174	613072
Guard	■	■
Inner support flange	■	■
Quick-locking nut	■	■
Side handle	■	■
Dust protection filter	■	■
without battery pack, without charger	■	■

- Product advantages**
- Speed and torque configured precisely for stainless steel processing ensuring a cool grinding action with perfect finish
  - Paddle switch with dead man function: safe to operate due to an ergonomically integrated non-slip switch
  - Slim design for prolonged comfort when working overhead or in areas with limited space
  - Metabo Quick for tool-free disc change by means of a quick-locking nut
  - Tool-free adjustable guard; twist-proof
  - Battery pack can be swivelled for better access in hard to reach places
  - Overload protection: protects the motor from overheating
  - Electronic soft start for smooth start-up
  - Restart protection: prevents unintentional start-up after power supply interruption
  - Detachable dust protection filter protects motor from coarse particles

**System components**

Accessories → 130 | Battery packs → 72

18 V  
Ø 125 mm



Technical data	Cordless Angle Grinder WB 18 LTX BL 125 Quick	Cordless Angle Grinder WPB 18 LTX BL 125 Quick
Type of battery pack	Li-Ion / LiHD	Li-Ion / LiHD
Battery pack voltage	18 V	18 V
Grinding wheel Ø	125 mm	125 mm
No-load speed	9,000 /min	9,000 /min
Spindle threads	M 14	M 14
Weight (including battery pack)	2.7 kg	2.8 kg

Scope of delivery	613077	613075
Guard	■	■
Inner support flange	■	■
Quick-locking nut	■	■
Side handle	■	■
Dust protection filter	■	■
2 LiHD battery packs (18 V/5.5 Ah)	■	■
Charger ASC 30-36 V »AIR COOLED«	■	■
Plastic carry case	■	■

- Product advantages**
- Paddle switch with dead man function: safe to operate due to an ergonomically integrated non-slip switch
  - Unique encapsulated Metabo brushless motor with optimum protection from dust provides quick work progress and the highest efficiency
  - Slim design for prolonged comfort when working overhead or in areas with limited space
  - Fast brake system with safety spindle for highest user safety: stops the disc within 2 seconds after switching off and prevents the nut from coming loose during the braking process
  - Metabo Quick for tool-free disc change by means of a quick-locking nut
  - Tool-free adjustable guard; twist-proof
  - Battery pack can be swivelled for better access in hard to reach places
  - Electronic safety shutdown: reduces kickback if the disc stops unexpectedly - for high user safety
  - Overload protection: protects the motor from overheating
  - Electronic soft start for smooth start-up
  - Restart protection: prevents unintentional start-up after power supply interruption
  - Detachable dust protection filter protects motor from coarse particles
  - Battery packs with capacity display for checking the charge status

**System components**

Accessories → 130 | Battery packs → 72

18 V  
 Ø 150 mm  
 Ø 180 mm



Technical data	Cordless Angle Grinder W 18 LTX 150 Quick	Cordless Angle Grinder WB 18 LTX BL 150 Quick	Cordless Angle Grinder WB 18 LTX BL 180
Type of battery pack	Li-Ion / LiHD	Li-Ion / LiHD	Li-Ion / LiHD
Battery pack voltage	18 V	18 V	18 V
Grinding wheel Ø	150 mm	150 mm	180 mm
No-load speed	8,000 /min	9,000 /min	8,200 /min
Spindle threads	M 14	M 14	M 14
Weight (including battery pack)	2.4 kg	2.6 kg	2.6 kg

Scope of delivery

Order no.	600404	613078	613087
Clip for cut-off guard	■		
Guard	■	■	■
2 Flexiarapid Inox cutting discs (150x1.6x22.2 mm)	■		
Inner support flange	■	■	■
Nut with two holes			■
Quick-locking nut	■	■	
Side handle	■	■	■
Dust protection filter	■	■	■
Flat-pin spanners			■
2 Li-Power battery packs (18 V/5.2 Ah)	■		
Charger ASC 30-36 V »AIR COOLED«	■		
Plastic carry case	■		
MetaLoc case			■
without battery pack, without charger		■	■

Product advantages

- Metabo Quick for tool-free disc change by means of a quick-locking nut
- Same cutting depth like a large mains angle grinder with Ø 230 mm; ideal for cutting jobs on the roof
- Unique encapsulated Metabo brushless motor with optimum protection from dust provides quick work progress and the highest efficiency
- Fast brake system for highest user safety stops the disc within a matter of seconds after switching off
- Electronic safety shutdown: reduces kickback if the disc stops unexpectedly - for high user safety
- Slim design for prolonged comfort when working overhead or in areas with limited space
- Tool-free adjustable guard; twist-proof
- Battery pack can be swivelled for better access in hard to reach places
- Detachable dust protection filter protects motor from coarse particles
- Overload protection, soft start and restart protection
- Battery packs with capacity display for checking the charge status

System components

Accessories → 130 | Battery packs → 72

2x 18 V  
 36 V  
 Ø 230 mm



Technical data	Cordless Angle Grinder WPB 36-18 LTX BL 230	Cordless Angle Grinder WPB 36 LTX BL 230
Type of battery pack	Li-Ion / LiHD	Li-Ion / LiHD
Battery pack voltage	18 V	36 V
Grinding wheel Ø	230 mm	230 mm
No-load speed	6,600 /min	6,600 /min
Spindle threads	M 14	M 14
Weight (including battery pack)	6.9 kg	6.1 kg

Scope of delivery

Order no.	613102 <sup>1)</sup>	613101 <sup>1)</sup>
Guard	■	■
Inner support flange	■	■
Nut with two holes	■	■
Metabo VibraTech (MVT) side handle	■	■
Flat-pin spanners	■	■
2 LiHD battery packs (36 V/6.2 Ah)		■
4 LiHD battery packs (18 V/8.0 Ah)	■	
»AIR COOLED« quick charger ASC Ultra		■
2 Quick chargers ASC Ultra »AIR COOLED«	■	
Plastic carry case	■	■
MetaLoc case	■	

<sup>1)</sup> also available in 120 V (North/Latin America)

Product advantages







- 100% compatibility with the 18 Volt class: powerful 36 Volt operation with two 18 Volt battery packs from Metabo
- World's first large angle grinder (Ø 230 mm) with battery pack operation for powerful cutting and roughing independent from the mains power
- Widest range of application thanks to extremely large cutting depth of 77 mm
- Unique encapsulated Metabo brushless motor with optimum protection from dust provides quick work progress and the highest efficiency
- Deadman's switch for high user safety
- Fast brake system for highest user safety stops the disc within a matter of seconds after switching off
- Tool-free adjustable guard; twist-proof
- Rotating main handle: high safety and better handling when cutting
- Metabo VibraTech (MVT) side handle for vibration damping to protect the user's health
- Side handle can be mounted in three positions
- Electronic safety shutdown: reduces kickback if the disc stops unexpectedly - for high user safety
- Overload protection, soft start and restart protection
- Battery packs with capacity display for checking the charge status

System components

Accessories → 130 | Battery packs → 72



# Overview of product benefits

Model	Rated input power	Particular product advantages	Model	Equipment											
				Marathon motor	S-automatic safety clutch: minimises kickback	Electronic safety shutdown: reduces kickback	Tool-free disc change	Tool-free adjustable guard	MVT side handle	Constant electronics	Soft start	Restart protection	Overload protection	Adjustable speed	Integrated auto-balancer
<b>850 W series - the professional entry level</b>															
 W 750-1....	750 W		W 750-1....												*
W 850-1....	850 W		W 850-1....												*
WP 850-1....	850 W		WP 850-1....												
<b>900 W series - the most compact ones</b>															
 W 9-1....	900 W	Particularly handy	W 9-1....												*
WP 9-1....	900 W	Particularly handy	WP 9-1....												
W 9-1.... Quick	900 W	Particularly handy	W 9-1.... Quick												*
WP 9-1.... Quick	900 W	Particularly handy	WP 9-1.... Quick												
<b>1,100 W series – the flexible ones also with adjustable speed</b>															
 WEA 10-125 Quick	1,000 W	Lowest vibrations, particularly handy	WEA 10-125 Quick							C					
WEV 10-125 Quick	1,000 W	Adjustable speed, particularly handy	WEV 10-125 Quick							VC					
W 1100-1....	1,100 W		W 1100-1....												*
<b>1,250 W series - the endurance pros</b>															
 WP 1200-1.... RT	1,200 W	Ergonomic soft handle	WP 1200-1.... RT												
W 12-1.... Quick	1,250 W		W 12-1.... Quick												*
W 12-125 HD	1,250 W	High torque and robust aluminium flange for processing stone	W 12-125 HD												*
WP 12-1.... Quick	1,250 W		WP 12-1.... Quick												
WPB 12-1.... Quick	1,250 W	High user safety	WPB 12-1.... Quick												
WA 12-125 Quick	1,250 W	Lowest vibrations	WA 12-125 Quick												*
WBA 12-125 Quick	1,250 W	High user protection, lowest vibrations	WBA 12-125 Quick												*
<b>1,550 W series - the power packs</b>															
 WE 1500-1.... RT	1,500 W	Ergonomic soft handle	WE 1500-1.... RT							TC					
WE 15-1.... Quick	1,550 W		WE 15-1.... Quick							TC					
WE 15-125 HD	1,550 W	High torque and robust aluminium flange for processing stone	WE 15-125 HD							TC					
WEP 15-1.... Quick	1,550 W		WEP 15-1.... Quick							TC					
WEA 15-125 Quick	1,550 W	Lowest vibrations	WEA 15-125 Quick							TC					
<b>1,550 W series - the specialists with adjustable speed</b>															
 WEV 1500-125 RT	1,500 W	Ergonomic soft handle	WEV 1500-125 RT							VTC					
WEV 15-1.... Quick	1,550 W		WEV 15-1.... Quick							VTC					
WEVA 15-1.... Quick	1,550 W	Lowest vibrations	WEVA 15-1.... Quick							VTC					
WEV 15-125 Quick HT	1,550 W	High torque for processing stone	WEV 15-125 Quick HT							VTC					
WEV 15-125 Quick Inox	1,550 W	Very high torque for the perfect stainless steel finish	WEV 15-125 Quick Inox							VTC					
<b>1,700 W series – the productivity geniuses</b>															
 WE 17-1.... Quick RT	1,750 W		WE 17-1.... Quick RT							TC					
WE 17-125 Quick	1,700 W		WE 17-125 Quick							TC					
WEV 17-125 Quick RT	1,750 W	Adjustable speed	WEV 17-125 Quick RT							VTC					
WEV 17-125 Quick Inox RT	1,750 W	High torque and adjustable speed for working with stainless steel	WEV 17-125 Quick Inox RT							VTC					
WEV 17-125 Quick	1,700 W	Adjustable speed	WEV 17-125 Quick							VTC					

\* Depends on countries

01

02

03

04

05

06

07

08

09

10

11



12



13

14

15

# Overview of product benefits

		Ø125 mm / 5,0"	Ø150 mm / 6,0"	Ø180 mm / 7,0"	Rated input power	Particular product advantages		Equipment														
Model								Model	Marathon motor	S-automatic safety clutch: minimises kickback	Electronic safety shutdown: reduces kickback	Tool-free disc change	Tool-free adjustable guard	MVT side handle	Constant electronics	Soft start	Restart protection	Overload protection	Adjustable speed	Integrated auto-balancer	Disc brake	Switch with deadmans function
<b>1,700 W series – the productivity geniuses</b>																						
	WEP 17-150 Quick	■	■		1.700 W			WEP 17-150 Quick	■	■					TC	■	■	■				■
	WEA 17-1.... Quick	■	■		1.700 W	Lowest vibrations		WEA 17-1.... Quick	■	■					TC	■	■	■				
	WEBA 17-125 Quick	■			1.700 W	High user protection, lowest vibrations		WEBA 17-125 Quick	■	■					TC	■	■	■				
	WEPBA 17-1.... Quick RT	■	■		1.750 W	High user protection, lowest vibrations		WEPBA 17-1.... Quick RT	■	■					TC	■	■				■	■
	WEPBA 17-1.... Quick	■	■		1.700 W	High user protection, lowest vibrations		WEPBA 17-1.... Quick	■	■					TC	■	■	■				■
<b>1,900 W series – the most productive lightweights</b>																						
	WE 19-180 Quick RT			■	1.900 W			WE 19-180 Quick RT	■	■					TC	■	■					
	WEA 19-180 Quick RT			■	1.900 W	High user protection, lowest vibrations		WEA 19-180 Quick RT	■	■					TC	■	■					■
	WEPBA 19-180 Quick RT			■	1.900 W	High user protection, lowest vibrations		WEPBA 19-180 Quick RT	■	■					TC	■	■					■

		Ø 180 mm / 7,0"	Ø 230 mm / 9,0"	Rated input power	Particular product advantages		Equipment															
Model							Model	Marathon-Motor	Electronic safety shutdown: reduces kickback	Tool-free disc change	Tool-free adjustable guard	MVT side handle	MVT damping system	Soft start	Restart protection	Overload protection	Integrated auto-balancer	Switch with deadmans function	Rotating main handle	Side handle can be mounted in three positions		
<b>2,200 W series – the powerful entry level</b>																						
	W 22-..... MVT	■	■		2.200 W		W 22-..... MVT	■											■*	■	■	
	WE 22-..... MVT	■	■		2.200 W		WE 22-..... MVT	■	■										■*	■	■	
	WE 22-230 MVT Quick		■		2.200 W		WE 22-230 MVT Quick	■	■	■										■	■	
<b>2,400 W series – the reliable work horses</b>																						
	W 24-..... MVT	■	■		2.400 W		W 24-..... MVT	■											■*	■	■	
	WE 24-..... MVT	■	■		2.400 W		WE 24-..... MVT	■	■										■*	■	■	
	WE 24-..... MVT Quick		■		2.400 W		WE 24-..... MVT Quick	■	■	■									■*	■	■	
	WEA 24-..... MVT Quick	■	■		2.400 W	Lowest vibrations	WEA 24-..... MVT Quick	■	■	■									■*	■	■	
<b>2,600 W series – the most powerful long-runners</b>																						
	W 26-..... MVT	■	■		2.600 W		W 26-..... MVT	■											■*	■	■	
	WE 26-..... MVT Quick		■		2.600 W		WE 26-..... MVT Quick	■	■	■									■*	■	■	
	WEA 26-..... MVT Quick		■		2.600 W	Lowest vibrations	WEA 26-..... MVT Quick	■	■	■									■*	■	■	

■\* depends on model variant

01

02

03

04

05

06

07

08

09

10

11

12

13

14

15

# The compact angle grinders without limits: Ultimate power – unmatched endurance.

We listened closely to what is important with regard to cutting and roughing. From now on you will define the limit - not your tool. Don't be afraid to challenge our power packs of up to 1,900 Watts: Our angle grinders go on and on, with high torque and maximum overload capacity – and impress with their perfect ergonomics. Maximum power has never been this compact.



**Minimal kick-back – maximum control**  
Metabo S-automatic mechanical safety clutch for lowest kick-back when the disc is jammed



**Fast, tool-free disc change**  
with M-Quick flange nut at the push of a button

MARATHON MOTOR

Metabo Marathon-motor for a longer service life and added ventilation



Safe working at heights thanks to anti-fall guard



### Low-fatigue roughing

- thanks to integrated Autobalancer
  - thanks to Metabo VibraTech (MVT) side handle
- For 50% less vibration and lower costs, thanks to half the consumption of discs



### High user safety

- Ergonomic paddle switch with dead man function
- Patented, mechanical disc brake

WEPBA 17-125 Quick DS

# The Metabo Marathon-motor: High-performance in the most demanding of applications.

The Metabo Marathon-motor, with patented dust protection, goes beyond previously known limits in terms of power, productivity and service life in extreme situations. With up to 20% more high overload capacity and 50% more torque, it perseveres without stopping when others are left behind. Marathon-motors are built in our factory in Germany: 100% "made in Germany".

MARATHON MOTOR

## Developed for long service life in extreme applications

- Increased robustness by virtue of additional protection against aggressive dusts:
- Flow-optimised dust protection cage accelerates dust particles from the machine
  - New epoxy resin powder around the field coil
  - 30% more abrasion protection resin at the rotor winding

2X LONGER LIFETIME NEW CARBON BRUSH SYSTEM

## Less wear and lower costs thanks to the new carbon brush system:

- 100% longer service life
- For all Metabo angle grinders with 1,550, 1,700 and 1,900 Watts
- Longest overall service life compared to the competition



Made in Germany

## Perfect ergonomics and control

### Patented field coil technology permits more power in reduced design

- for highest power density in any class
- for low-fatigue and safe working
- for the first 1,700 Watt angle grinder with the power of a large grinder and the compactness of a small one

## Longer service life



The dust protection filter keeps larger shavings away – perfect for working with ceramic fibre discs

## For applications of maximum hardness



The perfect choice for all applications – all models up to 1,900 Watts

## Control in constrained situations



Multi-position handle means the handle position can be infinitely variable

## Maximum productivity at 1,900 Watts

New 1,900W armature with more efficient cooling for even more high overload capacity in extreme situations and a longer motor life.



- Blades circulate the air
- Air turbulence absorbs the heat better



- More compact copper arrangement
- Less insulating resin in the gaps
- Significantly better motor-cooling

# Ø 100 mm



Technical data	Angle Grinder W 9-100	Angle Grinder WP 9-100
Grinding wheel Ø	100 mm	100 mm
Rated input power	900 W	900 W
Output power	550 W	550 W
No-load speed	10,500 /min	10,500 /min
Revolutions at rated load	7,500 /min	7,500 /min
Torque	2.5 Nm	2.5 Nm
Spindle threads	M 10	M 10
Weight (without mains cable)	2 kg	2.1 kg
Cable length	2.5 m	4 m

Scope of delivery	600350	600386
Order no.	600350	600386
Guard	■	■
Inner support flange	■	■
Nut with two holes	■	■
M-Quick flange nut		■
Side handle	■	■
Flat-pin spanners	■	

- Product advantages**
- Paddle switch with dead man function: safe to operate due to an ergonomically integrated non-slip switch
  - Low fatigue as never before: compact angle grinder with smallest handle circumference in its class for perfect ergonomics
  - Longer service life, more power: the Metabo Marathon-motor with patented dust protection, up to 20% more overload capacity and 50% more torque
  - Tool-free adjustable guard; twist-proof
  - Metabo S-automatic mechanical safety clutch: minimises kick-back to the lowest level when the disc jams unexpectedly - for maximum user safety and swift progress
  - Gear housing can be unscrewed, rotated in 90° steps and remounted for left-handed operation or cutting
  - Auto-stop carbon brushes to protect the motor

**System components**

Accessories → 130

# Ø 115 mm



Technical data	Angle Grinder W 750-115	Angle Grinder W 850-115	Angle Grinder WP 850-115
Grinding wheel Ø	115 mm	115 mm	115 mm
Rated input power	750 W	850 W	850 W
Output power	450 W	530 W	530 W
No-load speed	11,000 /min	11,000 /min	11,000 /min
Revolutions at rated load	7,000 /min	7,000 /min	7,000 /min
Torque	1.7 Nm	1.9 Nm	1.9 Nm
Spindle threads	M 14	M 14	M 14
Weight (without mains cable)	1.8 kg	2 kg	1.9 kg
Cable length	2.5 m	2.5 m	2.5 m

Scope of delivery	601230 <sup>1) 2)</sup>	601232 <sup>1)</sup>	601234 <sup>1) 2)</sup>
Order no.	601230 <sup>1) 2)</sup>	601232 <sup>1)</sup>	601234 <sup>1) 2)</sup>
Guard	■	■	■
Inner support flange	■	■	■
Nut with two holes	■	■	■
Side handle	■	■	■
Flat-pin spanners	■	■	■

<sup>1)</sup> also available in 120 V (North/Latin America)  
<sup>2)</sup> also available in 110 V (UK)

- Product advantages**
- Restart protection after power interruption
  - Paddle switch with dead man function: safe to operate due to an ergonomically integrated switch
  - Robust, universal and economical: ergonomic angle grinder for any application
  - Powerful motor with good overload capacity
  - Twist-proof guard
  - Auto-stop carbon brushes to protect the motor

**System components**

Accessories → 130

01  
02  
03  
04  
05  
06  
07  
08  
09  
10  
11  
12  
13  
14  
15

Ø 115 mm



Technical data	Angle Grinder W 9-115	Angle Grinder W 9-115 Quick	Angle Grinder WP 9-115 Quick
Grinding wheel Ø	115 mm	115 mm	115 mm
Rated input power	900 W	900 W	900 W
Output power	550 W	550 W	550 W
No-load speed	10,500 /min	10,500 /min	10,500 /min
Revolutions at rated load	7,500 /min	7,500 /min	7,500 /min
Torque	2.5 Nm	2.5 Nm	2.5 Nm
Spindle threads	M 14	M 14	M 14
Weight (without mains cable)	2.1 kg	2.1 kg	2.1 kg
Cable length	2.5 m	4 m	4 m

Scope of delivery	600354 <sup>1) 2)</sup>	600371 <sup>1)</sup>	600380 <sup>1)</sup>
Guard	■	■	■
Inner support flange	■	■	■
Nut with two holes	■	■	■
M-Quick flange nut		■	■
Side handle	■	■	■
Flat-pin spanners	■		

<sup>1)</sup> also available in 120 V (North/Latin America)  
<sup>2)</sup> also available in 110 V (UK)

- Product advantages**
- Restart protection after power interruption
  - Paddle switch with dead man function: safe to operate due to an ergonomically integrated non-slip switch
  - Tool free, fast disc change at the touch of a button with the Metabo M-Quick-System
  - Low fatigue as never before: compact angle grinder with smallest handle circumference in its class for perfect ergonomics
  - Longer service life, more power: the Metabo Marathon-motor with patented dust protection, up to 20% more overload capacity and 50% more torque
  - Tool-free adjustable guard; twist-proof
  - Metabo S-automatic mechanical safety clutch: minimises kick-back to the lowest level when the disc jams unexpectedly - for maximum user safety and swift progress
  - Gear housing can be unscrewed, rotated in 90° steps and remounted for left-handed operation or cutting
  - Auto-stop carbon brushes to protect the motor

System components

Accessories → 130

Ø 125 mm



Technical data	Angle Grinder W 750-125	Angle Grinder W 850-125	Angle Grinder WP 850-125
Grinding wheel Ø	125 mm	125 mm	125 mm
Rated input power	750 W	850 W	850 W
Output power	450 W	530 W	530 W
No-load speed	11,000 /min	11,000 /min	11,000 /min
Revolutions at rated load	7,000 /min	7,000 /min	7,000 /min
Torque	1.7 Nm	1.9 Nm	1.9 Nm
Spindle threads	M 14	M 14	M 14
Weight (without mains cable)	1.8 kg	2 kg	1.9 kg
Cable length	2.5 m	2.5 m	2.5 m

Scope of delivery	601231	601233 <sup>1)</sup>	601235
Guard	■	■	■
Inner support flange	■	■	■
Nut with two holes	■	■	■
Side handle	■	■	■
Flat-pin spanners	■	■	■

<sup>1)</sup> also available in 120 V (North/Latin America)

- Product advantages**
- Restart protection after power interruption
  - Paddle switch with dead man function: safe to operate due to an ergonomically integrated switch
  - Robust, universal and economical: ergonomic angle grinder for any application
  - Powerful motor with good overload capacity
  - Twist-proof guard
  - Auto-stop carbon brushes to protect the motor

System components

Accessories → 130

Ø 125 mm



Technical data	Angle Grinder W 9-125	Angle Grinder W 9-125 Quick	Angle Grinder WP 9-125 Quick
Grinding wheel Ø	125 mm	125 mm	125 mm
Rated input power	900 W	900 W	900 W
Output power	550 W	550 W	550 W
No-load speed	10,500 /min	10,500 /min	10,500 /min
Revolutions at rated load	7,500 /min	7,500 /min	7,500 /min
Torque	2.5 Nm	2.5 Nm	2.5 Nm
Spindle threads	M 14	M 14	M 14
Weight (without mains cable)	2.1 kg	2.1 kg	2.1 kg
Cable length	2.5 m	4 m	4 m

Scope of delivery	600376 <sup>1)</sup>	600374 <sup>1)</sup>	600384 <sup>1) 2)</sup>
Guard	■	■	■
Inner support flange	■	■	■
Nut with two holes	■	■	■
M-Quick flange nut	■	■	■
Side handle	■	■	■
Flat-pin spanners	■	■	■

<sup>1)</sup> also available in 120 V (North/Latin America)  
<sup>2)</sup> also available in 110 V (UK)

- Product advantages**
- Restart protection after power interruption
  - Paddle switch with dead man function: safe to operate due to an ergonomically integrated non-slip switch
  - Tool free, fast disc change at the touch of a button with the Metabo M-Quick-System
  - Low fatigue as never before: compact angle grinder with smallest handle circumference in its class for perfect ergonomics
  - Longer service life, more power: the Metabo Marathon-motor with patented dust protection, up to 20% more overload capacity and 50% more torque
  - Tool-free adjustable guard; twist-proof
  - Metabo S-automatic mechanical safety clutch: minimises kick-back to the lowest level when the disc jams unexpectedly - for maximum user safety and swift progress
  - Gear housing can be unscrewed, rotated in 90° steps and remounted for left-handed operation or cutting
  - Auto-stop carbon brushes to protect the motor

**System components**

Accessories → 130

Ø 125 mm



Technical data	Angle Grinder WEV 10-125 Quick	Angle Grinder WEA 10-125 Quick	Angle Grinder WP 1200-125 RT
Grinding wheel Ø	125 mm	125 mm	125 mm
Rated input power	1,000 W	1,000 W	1,200 W
Output power	590 W	590 W	720 W
No-load speed	2,800 - 10,500 /min	10,500 /min	11,000 /min
Revolutions at rated load	8,800 /min	8,800 /min	7,000 /min
Torque	2.7 Nm	2.7 Nm	3.2 Nm
Spindle threads	M 14	M 14	M 14
Weight (without mains cable)	2.1 kg	2.1 kg	2.4 kg
Cable length	4 m	4 m	4 m

Scope of delivery	600388 <sup>1) 2)</sup>	600389	601240 <sup>1) 2)</sup>
Guard	■	■	■
Inner support flange	■	■	■
Nut with two holes	■	■	■
M-Quick flange nut	■	■	■
Side handle	■	■	■
Flat-pin spanners	■	■	■

<sup>1)</sup> also available in 120 V (North/Latin America)  
<sup>2)</sup> also available in 110 V (UK)

- Product advantages**
- Thumbwheel controlled Vario-Constamatic (VC)-Full wave electronics ideal for working on materials requiring customised speeds, and at speeds which remain almost constant under load
  - Constamatic (C) Full-wave Electronics: fast work progress by means of almost constant speed under load
  - Best anti-vibration system: integrated AutoBalancer compensates to deliver up to less 50% less hand-arm vibration.
  - Efficient and robust angle grinder with ergonomic soft handle for low-fatigue working, especially overhead
  - Powerful motor with good overload capacity
  - Deadman's switch for high user safety
  - Low fatigue as never before: compact angle grinder, and smallest handle circumference in its class for perfect ergonomics
  - Longer service life, more power: the Metabo Marathon-motor with patented dust protection, up to 20% more overload capacity and 50% more torque
  - Tool free, fast disc change at the touch of a button with the Metabo M-Quick-System
  - Metabo S-automatic mechanical safety clutch: minimises kick-back to the lowest level when the disc jams unexpectedly - for maximum user safety and swift progress
  - Electronic overload protection, soft start and restart protection
  - Gear housing can be unscrewed, rotated in 90° steps and remounted for left-handed operation or cutting
  - Tool-free adjustable guard; twist-proof
  - Auto-stop carbon brushes to protect the motor

**System components**

Accessories → 130

Ø 125 mm



Technical data	Angle Grinder W 12-125 Quick	Angle Grinder W 12-125 HD	Angle Grinder WP 12-125 Quick	Angle Grinder WPB 12-125 Quick
Grinding wheel Ø	125 mm	125 mm	125 mm	125 mm
Rated input power	1,250 W	1,250 W	1,250 W	1,250 W
Output power	780 W	780 W	780 W	780 W
No-load speed	11,000 /min	9,600 /min	11,000 /min	11,000 /min
Revolutions at rated load	8,000 /min	8,800 /min	8,000 /min	8,000 /min
Torque	3.4 Nm	4.1 Nm	3.4 Nm	3.4 Nm
Spindle threads	M 14	M 14	M 14	M 14
Weight (without mains cable)	2.4 kg	2.5 kg	2.4 kg	2.6 kg
Cable length	4 m	4 m	4 m	4 m

Scope of delivery

Order no.	600398 <sup>1) 2)</sup>	600408 <sup>1)</sup>	600414	600428 <sup>1)</sup>
Guard	■	■	■	■
Inner support flange	■	■	■	■
Nut with two holes		■		
M-Quick flange nut	■		■	■
Metabo VibraTech (MVT) side handle	■	■	■	■
Flat-pin spanners		■		

<sup>1)</sup> also available in 120 V (North/Latin America)  
<sup>2)</sup> also available in 110 V (UK)

Product advantages

- Tool free, fast disc change at the touch of a button with the Metabo M-Quick-System
- Aluminium flange for long service life using heavy accessories, e.g. diamond discs
- Fastest brake system for highest user safety: patented, mechanical disc brake stops the disc within 2 seconds after switching off, even in the event of a power cut
- Restart protection after power interruption
- Tool free, fast disc change at the touch of a button with the Metabo M-Quick-System
- Paddle switch with dead man function: safe to operate due to an ergonomically integrated non-slip switch
- Long service life for demanding applications: powerful and robust angle grinder with highest power density in its class for quick work progress
- Longer service life, more power: the Metabo Marathon-motor with patented dust protection, up to 20% more overload capacity and 50% more torque
- Tool-free adjustable guard; twist-proof
- Low-vibration side handle Metabo VibraTech (MVT)
- Metabo S-automatic mechanical safety clutch: minimises kick-back to the lowest level when the disc jams unexpectedly - for maximum user safety and swift progress
- Gear housing can be unscrewed, rotated in 90° steps and remounted for left-handed operation or cutting
- Auto-stop carbon brushes to protect the motor

System components

Accessories → 130

Ø 125 mm

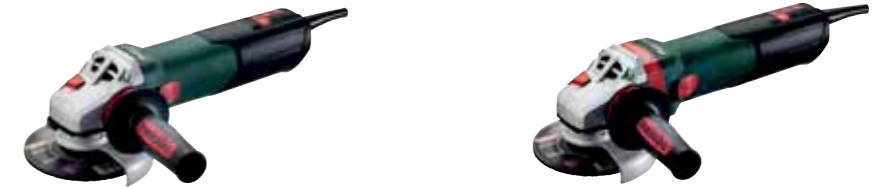

Technical data	Angle Grinder WA 12-125 Quick	Angle Grinder WBA 12-125 Quick
Grinding wheel Ø	125 mm	125 mm
Rated input power	1,250 W	1,250 W
Output power	780 W	780 W
No-load speed	11,000 /min	11,000 /min
Revolutions at rated load	8,000 /min	8,000 /min
Torque	3.4 Nm	3.4 Nm
Spindle threads	M 14	M 14
Weight (without mains cable)	2.4 kg	2.6 kg
Cable length	4 m	4 m

Scope of delivery

Order no.	600422 <sup>2)</sup>	600436
Guard	■	■
Inner support flange	■	■
M-Quick flange nut	■	■
Metabo VibraTech (MVT) side handle	■	■

<sup>2)</sup> also available in 110 V (UK)

Product advantages

- Fastest brake system for highest user safety: patented, mechanical disc brake stops the disc within 2 seconds after switching off, even in the event of a power cut
- Long service life for demanding applications: powerful and robust angle grinder with highest power density in its class for quick work progress
- Longer service life, more power: the Metabo Marathon-motor with patented dust protection, up to 20% more overload capacity and 50% more torque
- Tool free, fast disc change at the touch of a button with the Metabo M-Quick-System
- Tool-free adjustable guard; twist-proof
- Low-vibration side handle Metabo VibraTech (MVT)
- Best anti-vibration system: integrated auto-balancer for up to 50% less hand-arm vibrations, longer service life of the machine and up to twice the service life of the grinding wheels
- Metabo S-automatic mechanical safety clutch: minimises kick-back to the lowest level when the disc jams unexpectedly - for maximum user safety and swift progress
- Restart protection after power interruption
- Gear housing can be unscrewed, rotated in 90° steps and remounted for left-handed operation or cutting
- Auto-stop carbon brushes to protect the motor

System components

Accessories → 130

Ø 125 mm



Technical data	Angle Grinder WE 1500-125 RT	Angle Grinder WEV 1500-125 RT	Angle Grinder WEV 1500-125 Quick RT
Grinding wheel Ø	125 mm	125 mm	125 mm
Rated input power	1,500 W	1,500 W	1,500 W
Output power	900 W	900 W	900 W
No-load speed	11,000 /min	3,500 - 11,000 /min	3,500 - 11,000 /min
Revolutions at rated load	11,000 /min	11,000 /min	11,000 /min
Torque	4.2 Nm	4.2 Nm	4.2 Nm
Spindle threads	M 14	M 14	M 14
Weight (without mains cable)	2.4 kg	2.4 kg	2.4 kg
Cable length	4 m	4 m	4 m

Scope of delivery

Order no.	601241 <sup>2)</sup>	601243 <sup>1)</sup>	601243500 <sup>1)</sup>
Guard	■	■	■
Inner support flange	■	■	■
Nut with two holes	■	■	■
»Quick« flange nut			■
Side handle	■	■	■
Flat-pin spanners	■	■	■
Plastic carry case			■

<sup>1)</sup> also available in 120 V (North/Latin America)  
<sup>2)</sup> also available in 110 V (UK)

Product advantages

- Tacho Constamatic (TC) Full-wave Electronics: fast work progress by means of constant speed under load
- Metabo Quick for tool-free disc change by means of a quick-locking nut
- Vario Tacho Constamatic (VTC) Full-wave Electronics with Thumbwheel: for working at customised speeds to suit the application material and speeds that remain almost constant, even under load
- Powerful and robust angle grinder with ergonomic soft handle for low-fatigue working, especially overhead
- Powerful motor with good overload capacity
- Tool-free adjustable guard; twist-proof
- Electronic safety shutdown: reduces kickback if the disc stops unexpectedly - for high user safety
- Electronic soft start for smooth start-up
- Restart protection after power interruption
- Auto-stop carbon brushes to protect the motor

System components

Accessories → 130

Ø 125 mm



Technical data	Angle Grinder WE 15-125 Quick	Angle Grinder WE 15-125 HD	Angle Grinder WEP 15-125 Quick
Grinding wheel Ø	125 mm	125 mm	125 mm
Rated input power	1,550 W	1,550 W	1,550 W
Output power	940 W	940 W	940 W
No-load speed	11,000 /min	9,600 /min	11,000 /min
Revolutions at rated load	11,000 /min	9,600 /min	11,000 /min
Torque	3.5 Nm	4.2 Nm	3.5 Nm
Spindle threads	M 14	M 14	M 14
Weight (without mains cable)	2.5 kg	2.5 kg	2.5 kg
Cable length	4 m	4 m	4 m

Scope of delivery

Order no.	600448 <sup>1)2)</sup>	600465 <sup>1)</sup>	600476 <sup>1)</sup>
Guard	■	■	■
Inner support flange	■	■	■
Nut with two holes		■	
M-Quick flange nut	■		■
Metabo VibraTech (MVT) side handle	■	■	■
Flat-pin spanners		■	

<sup>1)</sup> also available in 120 V (North/Latin America)  
<sup>2)</sup> also available in 110 V (UK)

Product advantages

- Tool free, fast disc change at the touch of a button with the Metabo M-Quick-System
- Aluminium flange for long service life using heavy accessories, e.g. diamond discs
- Tool free, fast disc change at the touch of a button with the Metabo M-Quick-System
- Paddle switch with dead man function: safe to operate due to an ergonomically integrated non-slip switch
- Highest service life for extreme applications: robust, powerful angle grinder with maximum power density in its class for quick work progress
- Longer service life, more power: the Metabo Marathon-motor with patented dust protection, up to 20% more overload capacity and 50% more torque
- Tacho Constamatic (TC) Full-wave Electronics: fast work progress by means of constant speed under load
- Tool-free adjustable guard; twist-proof
- Low-vibration side handle Metabo VibraTech (MVT)
- Metabo S-automatic mechanical safety clutch: minimises kick-back to the lowest level when the disc jams unexpectedly - for maximum user safety and swift progress
- Electronic overload protection, soft start and restart protection
- Gear housing can be unscrewed, rotated in 90° steps and remounted for left-handed operation or cutting
- Auto-stop carbon brushes to protect the motor

System components

Accessories → 130



Ø 125 mm



Technical data

	Angle Grinder WEA 15-125 Quick	Angle Grinder WEVA 15-125 Quick	Angle Grinder WEV 15-125 Quick
Grinding wheel Ø	125 mm	125 mm	125 mm
Rated input power	1,550 W	1,550 W	1,550 W
Output power	940 W	940 W	940 W
No-load speed	11,000 /min	2,800 - 11,000 /min	2,800 - 11,000 /min
Revolutions at rated load	11,000 /min	11,000 /min	11,000 /min
Torque	3.5 Nm	3.5 Nm	3.5 Nm
Spindle threads	M 14	M 14	M 14
Weight (without mains cable)	2.5 kg	2.5 kg	2.5 kg
Cable length	4 m	4 m	4 m

Scope of delivery

Order no.	600492 <sup>2)</sup>	600496	600468 <sup>1)</sup>
Guard	■	■	■
Inner support flange	■	■	■
M-Quick flange nut	■	■	■
Metabo VibraTech (MVT) side handle	■	■	■

<sup>1)</sup> also available in 120 V (North/Latin America)  
<sup>2)</sup> also available in 110 V (UK)

Product advantages

- Tacho Constamatic (TC) Full-wave Electronics: fast work progress by means of constant speed under load
- Vario Tacho Constamatic (VTC) Full-wave Electronics with Thumbwheel: for working at customised speeds to suit the application material and speeds that remain almost constant, even under load
- Best anti-vibration system: integrated auto-balancer for up to 50% less hand-arm vibrations, longer service life of the machine and up to twice the service life of the grinding wheels
- Highest service life for extreme applications: robust, powerful angle grinder with maximum power density in its class for quick work progress
- Longer service life, more power: the Metabo Marathon-motor with patented dust protection, up to 20% more overload capacity and 50% more torque
- Tool free, fast disc change at the touch of a button with the Metabo M-Quick-System
- Tool-free adjustable guard; twist-proof
- Metabo S-automatic mechanical safety clutch: minimises kick-back to the lowest level in the event the disc jams
- Electronic overload protection, soft start and restart protection
- Gear housing can be unscrewed, rotated in 90° steps and remounted for left-handed operation or cutting
- Auto-stop carbon brushes to protect the motor

System components

Accessories → 130

Ø 125 mm



Technical data

	Angle Grinder WEV 15-125 Quick HT	Angle Grinder WEV 15-125 Quick Inox
Grinding wheel Ø	125 mm	125 mm
Rated input power	1,550 W	1,550 W
Output power	940 W	940 W
No-load speed	2,800 - 9,600 /min	2,000 - 7,600 /min
Revolutions at rated load	9,600 /min	7,600 /min
Torque	4.2 Nm	5 Nm
Spindle threads	M 14	M 14
Weight (without mains cable)	2.5 kg	2.5 kg
Cable length	4 m	4 m

Scope of delivery

Order no.	600562 <sup>1)</sup>	600572 <sup>1)</sup>
Guard	■	■
Inner support flange	■	■
M-Quick flange nut	■	■
Metabo VibraTech (MVT) side handle	■	■

<sup>1)</sup> also available in 120 V (North/Latin America)

Product advantages

- Optimum processing of stone: robust, powerful angle grinder with gear reduction and reduced, adjustable speed for material-friendly working
- Perfect processing of stainless steel: robust, powerful angle grinder with high gear reduction and adjustable reduced speed for cool finish
- Longer service life, more power: the Metabo Marathon-motor with patented dust protection, up to 20% more overload capacity and 50% more torque
- Vario Tacho Constamatic (VTC) Full-wave Electronics with Thumbwheel: for working at customised speeds to suit the application material and speeds that remain almost constant, even under load
- Tool free, fast disc change at the touch of a button with the Metabo M-Quick-System
- Tool-free adjustable guard; twist-proof
- Low-vibration side handle Metabo VibraTech (MVT)
- Metabo S-automatic mechanical safety clutch: minimises kick-back to the lowest level when the disc jams unexpectedly - for maximum user safety and swift progress
- Electronic overload protection, soft start and restart protection
- Gear housing can be unscrewed, rotated in 90° steps and remounted for left-handed operation or cutting
- Auto-stop carbon brushes to protect the motor

System components

Accessories → 130

01  
02  
03  
04  
05  
06  
07  
08  
09  
10  
11  
12  
13  
14  
15

Ø 125 mm



Technical data	Angle Grinder WE 17-125 Quick RT	Angle Grinder WEV 17-125 Quick RT	Angle Grinder WEV 17-125 Quick Inox RT
Grinding wheel Ø	125 mm	125 mm	125 mm
Rated input power	1,750 W	1,750 W	1,750 W
Output power	1,070 W	1,070 W	1,070 W
No-load speed	11,000 /min	2,800 - 11,000 /min	2,000 - 7,600 /min
Revolutions at rated load	11,000 /min	11,000 /min	7,600 /min
Torque	3.8 Nm	3.8 Nm	5 Nm
Spindle threads	M 14	M 14	M 14
Weight (without mains cable)	2.5 kg	2.5 kg	2.5 kg
Cable length	4 m	4 m	4 m

Scope of delivery	601086 <sup>1)</sup>	601089	601092
Guard	■	■	■
Inner support flange	■	■	■
M-Quick flange nut	■	■	■
Metabo VibraTech (MVT) side handle	■	■	■

<sup>1)</sup> also available in 120 V (North/Latin America)

- Product advantages**
- Tacho Constamatic (TC) Full-wave Electronics: fast work progress by means of constant speed under load
  - Vario Tacho Constamatic (VTC) Full-wave Electronics with Thumbwheel: for working at customised speeds to suit the application material and speeds that remain almost constant, even under load
  - The specialist with high torque and speed control for processing stainless steel and for working with aggressive fibre discs
  - Perfect ergonomics thanks to slim handle for maximum control and easy working overhead
  - Metabo Marathon-motor with new cooling and carbon brush system for twice the service life
  - M-Quick System for tool-free disc change at the touch of a button
  - Tool-free adjustable guard; twist-proof
  - Low-vibration side handle Metabo VibraTech (MVT)
  - Metabo S-automatic mechanical safety clutch: minimises kick-back to the lowest level when the disc jams unexpectedly - for maximum user safety and swift progress
  - Electronic soft start and restart protection
  - Gear housing can be unscrewed, rotated in 90° steps and remounted for left-handed operation or cutting
  - Auto-stop carbon brushes to protect the motor

System components

Accessories → 130

Ø 125 mm



Technical data	Angle Grinder WE 17-125 Quick	Angle Grinder WEV 17-125 Quick	Angle Grinder WEA 17-125 Quick
Grinding wheel Ø	125 mm	125 mm	125 mm
Rated input power	1,700 W	1,700 W	1,700 W
Output power	1,040 W	1,040 W	1,040 W
No-load speed	11,000 /min	2,800 - 11,000 /min	11,000 /min
Revolutions at rated load	11,000 /min	11,000 /min	11,000 /min
Torque	3.7 Nm	3.7 Nm	3.7 Nm
Spindle threads	M 14	M 14	M 14
Weight (without mains cable)	2.5 kg	2.5 kg	2.5 kg
Cable length	4 m	4 m	4 m

Scope of delivery	600515 <sup>2)</sup>	600516	600534
Guard	■	■	■
Inner support flange	■	■	■
M-Quick flange nut	■	■	■
Metabo VibraTech (MVT) side handle	■	■	■

<sup>2)</sup> also available in 110 V (UK)

- Product advantages**
- Tacho Constamatic (TC) Full-wave Electronics: fast work progress by means of constant speed under load
  - Vario Tacho Constamatic (VTC) Full-wave Electronics with Thumbwheel: for working at customised speeds to suit the application material and speeds that remain almost constant, even under load
  - Tacho Constamatic (TC) Full-wave Electronics: fast work progress by means of constant speed under load
  - Best anti-vibration system: integrated auto-balancer for up to 50% less hand-arm vibrations, longer service life of the machine and up to twice the service life of the grinding wheels
  - Maximum productivity: 1,700 Watt angle grinder with the power of a large grinder and the compactness of a small one for quickest material removal on industrial applications
  - Longer service life, more power: the Metabo Marathon-motor with patented dust protection, up to 20% more overload capacity and 50% more torque
  - Tool free, fast disc change at the touch of a button with the Metabo M-Quick-System
  - Tool-free adjustable guard; twist-proof
  - Low-vibration side handle Metabo VibraTech (MVT)
  - Metabo S-automatic mechanical safety clutch: minimises kick-back to the lowest level when the disc jams unexpectedly - for maximum user safety and swift progress
  - Gear housing can be unscrewed, rotated in 90° steps and remounted for left-handed operation or cutting
  - Electronic overload protection, soft start and restart protection
  - Auto-stop carbon brushes to protect the motor

System components

Accessories → 130

Ø 125 mm



Technical data	Angle Grinder WEBA 17-125 Quick	Angle Grinder WEPBA 17-125 Quick
Grinding wheel Ø	125 mm	125 mm
Rated input power	1,700 W	1,700 W
Output power	1,040 W	1,040 W
No-load speed	11,000 /min	11,000 /min
Revolutions at rated load	11,000 /min	11,000 /min
Torque	3.7 Nm	3.7 Nm
Spindle threads	M 14	M 14
Weight (without mains cable)	2.7 kg	2.7 kg
Cable length	4 m	4 m

Scope of delivery	600514	600548 <sup>1) 2)</sup>
Order no.	600514	600548 <sup>1) 2)</sup>
Guard	■	■
Inner support flange	■	■
M-Quick flange nut	■	■
Metabo VibraTech (MVT) side handle	■	■

<sup>1)</sup> also available in 120 V (North/Latin America)  
<sup>2)</sup> also available in 110 V (UK)

- Product advantages**
- Paddle switch with dead man function: safe to operate due to an ergonomically integrated non-slip switch
  - Maximum productivity: 1,700 Watt angle grinder with the power of a large grinder and the compactness of a small one for quickest material removal on industrial applications
  - Longer service life, more power: the Metabo Marathon-motor with patented dust protection, up to 20% more overload capacity and 50% more torque
  - Tacho Constamatic (TC) Full-wave Electronics: fast work progress by means of constant speed under load
  - Tool free, fast disc change at the touch of a button with the Metabo M-Quick-System
  - Tool-free adjustable guard; twist-proof
  - Low-vibration side handle Metabo VibraTech (MVT)
  - Best anti-vibration system: integrated auto-balancer for up to 50% less hand-arm vibrations, longer service life of the machine and up to twice the service life of the grinding wheels
  - Fastest brake system for highest user safety: patented, mechanical disc brake stops the disc within 2 seconds after switching off, even in the event of a power cut
  - Metabo S-automatic mechanical safety clutch: minimises kick-back to the lowest level when the disc jams unexpectedly - for maximum user safety and swift progress
  - Electronic overload protection, soft start and restart protection
  - Gear housing can be unscrewed, rotated in 90° steps and remounted for left-handed operation or cutting
  - Auto-stop carbon brushes to protect the motor

**System components**

Accessories → 130

Ø 125 mm

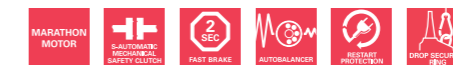

Technical data	Angle Grinder WEPBA 17-125 Quick DS	Angle Grinder WEPBA 17-125 Quick RT
Grinding wheel Ø	125 mm	125 mm
Rated input power	1,700 W	1,750 W
Output power	1,040 W	1,070 W
No-load speed	11,000 /min	11,000 /min
Revolutions at rated load	11,000 /min	11,000 /min
Torque	3.7 Nm	3.8 Nm
Spindle threads	M 14	M 14
Weight (without mains cable)	2.7 kg	2.7 kg
Cable length	4 m	4 m

Scope of delivery	600549 <sup>1)</sup>	601097 <sup>2)</sup>
Order no.	600549 <sup>1)</sup>	601097 <sup>2)</sup>
Guard	■	■
Inner support flange	■	■
M-Quick flange nut	■	■
Metabo VibraTech (MVT) side handle	■	■

<sup>1)</sup> also available in 120 V (North/Latin America)  
<sup>2)</sup> also available in 110 V (UK)

- Product advantages**
- Steel ring to accommodate the carabiner secures the angle grinder against falling when working at great heights
  - Perfect ergonomics thanks to slim handle for maximum control and easy working overhead
  - Maximum productivity: 1,700 Watt angle grinder with the power of a large grinder and the compactness of a small one for quickest material removal on industrial applications
  - Longer service life, more power: the Metabo Marathon-motor with patented dust protection, up to 20% more overload capacity and 50% more torque
  - Tacho Constamatic (TC) Full-wave Electronics: fast work progress by means of constant speed under load
  - M-Quick System for tool-free disc change at the touch of a button
  - Tool-free adjustable guard; twist-proof
  - Reduced vibrations for low-fatigue working thanks to Metabo VibraTech (MVT) side handle and integrated Auto-balancer
  - Highest degree of user safety thanks to patented, mechanical disc brake and deadman's switch: disc stop in 2 seconds after releasing even in case of a power cut
  - Metabo S-automatic mechanical safety clutch: minimises kick-back to the lowest level when the disc jams unexpectedly - for maximum user safety and swift progress
  - Gear housing can be unscrewed, rotated in 90° steps and remounted for left-handed operation or cutting
  - Electronic soft start and restart protection
  - Auto-stop carbon brushes to protect the motor

**System components**

Accessories → 130

Ø 150 mm



Technical data	Angle Grinder W 12-150 Quick	Angle Grinder WE 1500-150 RT
Grinding wheel Ø	150 mm	150 mm
Rated input power	1,250 W	1,500 W
Output power	780 W	900 W
No-load speed	9,600 /min	9,600 /min
Revolutions at rated load	7,000 /min	9,600 /min
Torque	3.8 Nm	5 Nm
Spindle threads	M 14	M 14
Weight (without mains cable)	2.5 kg	2.4 kg
Cable length	4 m	4 m

Scope of delivery

Order no.	600407 <sup>1)</sup>	601242 <sup>1)</sup>
Guard	■	■
Inner support flange	■	■
Nut with two holes	■	■
M-Quick flange nut	■	■
Side handle	■	■
Metabo VibraTech (MVT) side handle	■	■
Flat-pin spanners	■	■

<sup>1)</sup> also available in 120 V (North/Latin America)

Product advantages

- Long service life for demanding applications: powerful and robust angle grinder with highest power density in its class for quick work progress
- Longer service life, more power: the Metabo Marathon-motor with patented dust protection, up to 20% more overload capacity and 50% more torque
- Tool free, fast disc change at the touch of a button with the Metabo M-Quick-System
- Low-vibration side handle Metabo VibraTech (MVT)
- Metabo S-automatic mechanical safety clutch: minimises kick-back to the lowest level when the disc jams unexpectedly - for maximum user safety and swift progress
- Gear housing can be unscrewed, rotated in 90° steps and remounted for left-handed operation or cutting
- Powerful and robust angle grinder with ergonomic soft handle for low-fatigue working, especially overhead
- Powerful motor with good overload capacity
- Tacho Constamatic (TC) Full-wave Electronics: fast work progress by means of constant speed under load
- Electronic soft start for smooth start-up
- Tool-free adjustable guard; twist-proof
- Restart protection after power interruption
- Auto-stop carbon brushes to protect the motor

System components

Accessories → 130

Ø 150 mm



Technical data	Angle Grinder WE 15-150 Quick	Angle Grinder WEP 15-150 Quick
Grinding wheel Ø	150 mm	150 mm
Rated input power	1,550 W	1,550 W
Output power	940 W	940 W
No-load speed	9,600 /min	9,600 /min
Revolutions at rated load	9,600 /min	9,600 /min
Torque	3.9 Nm	3.9 Nm
Spindle threads	M 14	M 14
Weight (without mains cable)	2.6 kg	2.6 kg
Cable length	4 m	4 m

Scope of delivery

Order no.	600464 <sup>1)</sup>	600488 <sup>1)</sup>
Guard	■	■
Inner support flange	■	■
M-Quick flange nut	■	■
Metabo VibraTech (MVT) side handle	■	■

<sup>1)</sup> also available in 120 V (North/Latin America)

Product advantages

- Highest service life for extreme applications: robust, powerful angle grinder with maximum power density in its class for quick work progress
- Longer service life, more power: the Metabo Marathon-motor with patented dust protection, up to 20% more overload capacity and 50% more torque
- Tacho Constamatic (TC) Full-wave Electronics: fast work progress by means of constant speed under load
- Tool free, fast disc change at the touch of a button with the Metabo M-Quick-System
- Tool-free adjustable guard; twist-proof
- Low-vibration side handle Metabo VibraTech (MVT)
- Metabo S-automatic mechanical safety clutch: minimises kick-back to the lowest level when the disc jams unexpectedly - for maximum user safety and swift progress
- Electronic overload protection, soft start and restart protection
- Gear housing can be unscrewed, rotated in 90° steps and remounted for left-handed operation or cutting
- Auto-stop carbon brushes to protect the motor
- Paddle switch with dead man function: safe to operate due to an ergonomically integrated switch

System components

Accessories → 130

01  
02  
03  
04  
05  
06  
07  
08  
09  
10  
11  
12  
13  
14  
15

Ø 150 mm



Technical data	Angle Grinder WEA 15-150 Quick	Angle Grinder WEVA 15-150 Quick	Angle Grinder WEV 15-150 Quick
Grinding wheel Ø	150 mm	150 mm	150 mm
Rated input power	1,550 W	1,550 W	1,550 W
Output power	940 W	940 W	940 W
No-load speed	9,600 /min	2,800 - 9,600 /min	2,800 - 9,600 /min
Revolutions at rated load	9,600 /min	9,600 /min	9,600 /min
Torque	3.9 Nm	3.9 Nm	3.9 Nm
Spindle threads	M 14	M 14	M 14
Weight (without mains cable)	2.6 kg	2.6 kg	2.6 kg
Cable length	4 m	4 m	4 m

Scope of delivery	600493	600506	600472
Order no.	600493	600506	600472
Guard	■	■	■
Inner support flange	■	■	■
M-Quick flange nut	■	■	■
Metabo VibraTech (MVT) side handle	■	■	■

- Product advantages**
- Tacho Constamatic (TC) Full-wave Electronics: fast work progress by means of constant speed under load
  - Vario Tacho Constamatic (VTC) Full-wave Electronics with Thumbwheel: for working at customised speeds to suit the application material and speeds that remain almost constant, even under load
  - Best anti-vibration system: integrated auto-balancer for up to 50% less hand-arm vibrations, longer service life of the machine and up to twice the service life of the grinding wheels
  - Highest service life for extreme applications: robust, powerful angle grinder with maximum power density in its class for quick work progress
  - Longer service life, more power: the Metabo Marathon-motor with patented dust protection, up to 20% more overload capacity and 50% more torque
  - Tool free, fast disc change at the touch of a button with the Metabo M-Quick-System
  - Tool-free adjustable guard; twist-proof
  - Low-vibration side handle Metabo VibraTech (MVT)
  - Metabo S-automatic mechanical safety clutch: minimises kick-back to the lowest level when the disc jams unexpectedly - for maximum user safety and swift progress
  - Electronic overload protection, soft start and restart protection
  - Gear housing can be unscrewed, rotated in 90° steps and remounted for left-handed operation or cutting
  - Auto-stop carbon brushes to protect the motor

System components

Accessories → 130

Ø 150 mm



Technical data	Angle Grinder WE 17-150 Quick RT	Angle Grinder WEA 17-150 Quick
Grinding wheel Ø	150 mm	150 mm
Rated input power	1,750 W	1,700 W
Output power	1,070 W	1,040 W
No-load speed	9,600 /min	9,600 /min
Revolutions at rated load	9,600 /min	9,600 /min
Torque	4.4 Nm	4.3 Nm
Spindle threads	M 14	M 14
Weight (without mains cable)	2.5 kg	2.5 kg
Cable length	4 m	4 m

Scope of delivery	601087	600535
Order no.	601087	600535
Guard	■	■
Inner support flange	■	■
M-Quick flange nut	■	■
Metabo VibraTech (MVT) side handle	■	■

- Product advantages**
- Perfect ergonomics thanks to slim handle for maximum control and easy working overhead
  - Electronic soft start and restart protection
  - Best anti-vibration system: integrated auto-balancer for up to 50% less hand-arm vibrations, longer service life of the machine and up to twice the service life of the grinding wheels
  - Electronic overload protection, soft start and restart protection
  - Maximum productivity: 1,700 Watt angle grinder with the power of a large grinder and the compactness of a small one for quickest material removal on industrial applications
  - Longer service life, more power: the Metabo Marathon-motor with patented dust protection, up to 20% more overload capacity and 50% more torque
  - Tacho Constamatic (TC) Full-wave Electronics: fast work progress by means of constant speed under load
  - M-Quick System for tool-free disc change at the touch of a button
  - Tool-free adjustable guard; twist-proof
  - Low-vibration side handle Metabo VibraTech (MVT)
  - Metabo S-automatic mechanical safety clutch: minimises kick-back to the lowest level when the disc jams unexpectedly - for maximum user safety and swift progress
  - Gear housing can be unscrewed, rotated in 90° steps and remounted for left-handed operation or cutting
  - Auto-stop carbon brushes to protect the motor

System components

Accessories → 130

Ø 150 mm



Technical data	Angle Grinder WEPBA 17-150 Quick	Angle Grinder WEPBA 17-150 Quick RT
Grinding wheel Ø	150 mm	150 mm
Rated input power	1,700 W	1,750 W
Output power	1,040 W	1,070 W
No-load speed	9,600 /min	9,600 /min
Revolutions at rated load	9,600 /min	9,600 /min
Torque	4.3 Nm	4.4 Nm
Spindle threads	M 14	M 14
Weight (without mains cable)	2.8 kg	2.8 kg
Cable length	4 m	4 m

Scope of delivery	600552 <sup>1) 2)</sup>	601098
Order no.	600552 <sup>1) 2)</sup>	601098
Guard	■	■
Inner support flange	■	■
M-Quick flange nut	■	■
Metabo VibraTech (MVT) side handle	■	■

<sup>1)</sup> also available in 120 V (North/Latin America)

<sup>2)</sup> also available in 110 V (UK)

Product advantages

- Electronic overload protection, soft start and restart protection
- Perfect ergonomics thanks to slim handle for maximum control and easy working overhead
- Electronic soft start and restart protection
- Maximum productivity: 1,700 Watt angle grinder with the power of a large grinder and the compactness of a small one for quickest material removal on industrial applications
- Longer service life, more power: the Metabo Marathon-motor with patented dust protection, up to 20% more overload capacity and 50% more torque
- Tacho Constamatic (TC) Full-wave Electronics: fast work progress by means of constant speed under load
- M-Quick System for tool-free disc change at the touch of a button
- Tool-free adjustable guard; twist-proof
- Reduced vibrations for low-fatigue working thanks to Metabo VibraTech (MVT) side handle and integrated Auto-balancer
- Highest degree of user safety thanks to patented, mechanical disc brake and deadman's switch: disc stop in 2 seconds after releasing even in case of a power cut
- Metabo S-automatic mechanical safety clutch: minimises kick-back to the lowest level when the disc jams unexpectedly - for maximum user safety and swift progress
- Gear housing can be unscrewed, rotated in 90° steps and remounted for left-handed operation or cutting
- Auto-stop carbon brushes to protect the motor

System components

Accessories ▶ 130

Ø 180 mm



Technical data	Angle Grinder WE 19-180 Quick RT	Angle Grinder WEA 19-180 Quick RT	Angle Grinder WEPBA 19-180 Quick RT
Grinding wheel Ø	180 mm	180 mm	180 mm
Rated input power	1,900 W	1,900 W	1,900 W
Output power	1,240 W	1,240 W	1,240 W
No-load speed	8,200 /min	8,200 /min	8,200 /min
Revolutions at rated load	8,200 /min	8,200 /min	8,200 /min
Torque	5 Nm	5 Nm	5 Nm
Spindle threads	M 14	M 14	M 14
Weight (without mains cable)	2.7 kg	2.7 kg	2.9 kg
Cable length	4 m	4 m	4 m

Scope of delivery	601088	601095	601099 <sup>2)</sup>
Order no.	601088	601095	601099 <sup>2)</sup>
Guard	■	■	■
Inner support flange	■	■	■
M-Quick flange nut	■	■	■
Metabo VibraTech (MVT) side handle	■	■	■

<sup>2)</sup> also available in 110 V (UK)

Product advantages

- Low-vibration side handle Metabo VibraTech (MVT)
- Highest degree of user safety thanks to patented, mechanical disc brake and deadman's switch: disc stop in 2 seconds after releasing even in case of a power cut
- Reduced vibrations for low-fatigue working thanks to Metabo VibraTech (MVT) side handle and integrated Auto-balancer
- The most powerful one with full 1,900 Watt for industrial processing of weld seams and a cutting depth like a large angle grinder (Ø 230 mm) with only half the weight
- Perfect ergonomics thanks to slim handle for maximum control and easy working overhead
- Metabo Marathon-motor with new cooling and carbon brush system for twice the service life
- Tacho Constamatic (TC) Full-wave Electronics: fast work progress by means of constant speed under load
- M-Quick System for tool-free disc change at the touch of a button
- Tool-free adjustable guard; twist-proof
- Metabo S-automatic mechanical safety clutch: minimises kick-back to the lowest level when the disc jams unexpectedly - for maximum user safety and swift progress
- Electronic soft start and restart protection
- Gear housing can be unscrewed, rotated in 90° steps and remounted for left-handed operation or cutting
- Auto-stop carbon brushes to protect the motor

System components

Accessories ▶ 130

# Large angle grinders from Metabo: The right choice for continuous industrial operation.

Regardless of whether it's prolonged roughing work or heavy cutting work, e.g. plunge cuts into 30 mm solid material: Metabo's large angle grinders with their powerful marathon-motors won't let you down. For maximum safety and optimal handling the main handle can be twisted: helpful when cutting.

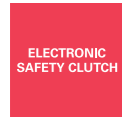

**Minimal kick-back – maximum control**  
Electronic safety shutdown for reduced kickback if the disc jams

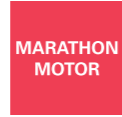

- Metabo Marathon-motor**
- Patented dust protection
  - Up to 20% more overload capacity
  - Up to 50 % more torque



- Low-fatigue roughing**
- Switch with dead man function  
Switches off the machine immediately if control is lost



**Fast, easy disc change**  
with quick-locking nut



- Low-fatigue roughing**
- Thanks to integrated Autobalancer
  - Thanks to Metabo VibraTech (MVT) damping system and side handle
- For up to 50% less vibration and halve the disc consumption

WEA 26-230 MVT Quick



**Twist handle for safe cutting**  
Rotating main handle for more safety and better handling when cutting up to 65 mm



**Change accessories quickly and easily**  
»Quick« flange nut for changing cutting or grinding discs without flat-pin spanner, meaning you can work without interruption



**The right disc for every application**  
Large range of diamond cutting discs as well as cutting and roughing discs



Ø 180 mm

**Technical data**

	Angle Grinder W 22-180 MVT	Angle Grinder W 24-180 MVT	Angle Grinder WE 22-180 MVT	Angle Grinder WE 24-180 MVT
Grinding wheel Ø	180 mm	180 mm	180 mm	180 mm
Rated input power	2,200 W	2,400 W	2,200 W	2,400 W
Output power	1,500 W	1,600 W	1,500 W	1,600 W
No-load speed	8,500 /min	8,500 /min	8,500 /min	8,500 /min
Revolutions at rated load	5,800 /min	5,800 /min	5,800 /min	5,800 /min
Torque	11 Nm	14 Nm	11 Nm	14 Nm
Spindle threads	M 14	M 14	M 14	M 14
Weight (without mains cable)	5.7 kg	5.7 kg	5.7 kg	5.7 kg
Cable length	4 m	4 m	4 m	4 m

**Scope of delivery**

Order no.	606461 <sup>2)</sup>	606466 <sup>1)</sup>	606463	606468
Guard	■	■	■	■
Inner support flange	■	■	■	■
Nut with two holes	■	■	■	■
Metabo VibraTech (MVT) side handle	■	■	■	■
Flat-pin spanners	■	■	■	■

<sup>1)</sup> also available in 120 V (North/Latin America)  
<sup>2)</sup> also available in 110 V (UK)

**Product advantages**

- Dead man switch for high user protection (optional)
- Starting current limitation prevents the actuation of the lock on start-up
- Electronic safety shutdown: reduces kickback if the disc stops unexpectedly - for high user safety
- Electronic overload protection and restart protection
- LED signal indicates triggered restart protection or overheating
- Metabo Marathon-motor with patented dust protection for long service life
- Metabo safety switch prevents unintentional start
- Tool-free adjustable guard; twist-proof
- Metabo VibraTech (MVT): integrated damping system and side handle to reduce vibrations in order to protect the user's health
- Side handle can be mounted in three positions
- Rotating main handle: high safety and better handling when cutting
- Auto-stop carbon brushes to protect the motor

**System components**

Accessories → 130



Ø 180 mm



Technical data	Angle Grinder WEA 24-180 MVT Quick	Angle Grinder W 26-180 MVT
Grinding wheel Ø	180 mm	180 mm
Rated input power	2,400 W	2,600 W
Output power	1,600 W	1,800 W
No-load speed	8,500 /min	8,500 /min
Revolutions at rated load	5,800 /min	6,000 /min
Torque	14 Nm	17 Nm
Spindle threads	M 14	M 14
Weight (without mains cable)	5.8 kg	6.2 kg
Cable length	4 m	4 m

Scope of delivery	606471	606473
Order no.	606471	606473
Guard	■	■
Inner support flange	■	■
Nut with two holes	■	■
Quick-locking nut	■	■
Metabo VibraTech (MVT) side handle	■	■
Flat-pin spanners	■	■

- Product advantages**
- Best anti-vibration system: integrated auto-balancer for up to 50% less hand-arm vibrations, longer service life of the machine and up to twice the service life of the grinding wheels
  - Starting current limitation prevents the actuation of the lock on start-up
  - Electronic safety shutdown: reduces kickback if the disc stops unexpectedly - for high user safety
  - Electronic overload protection and restart protection
  - LED signal indicates triggered restart protection or overheating
  - Metabo Quick for tool-free disc change by means of a quick-locking nut
  - Dead man switch for high user protection (optional)
  - Metabo Marathon-motor with patented dust protection for long service life
  - Metabo safety switch prevents unintentional start
  - Tool-free adjustable guard; twist-proof
  - Metabo VibraTech (MVT): integrated damping system and side handle to reduce vibrations in order to protect the user's health
  - Side handle can be mounted in three positions
  - Rotating main handle: high safety and better handling when cutting
  - Auto-stop carbon brushes to protect the motor

System components

Accessories → 130



Ø 230 mm

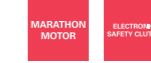

Technical data	Angle Grinder W 22-230 MVT	Angle Grinder WE 22-230 MVT	Angle Grinder WE 22-230 MVT Quick
Grinding wheel Ø	230 mm	230 mm	230 mm
Rated input power	2,200 W	2,200 W	2,200 W
Output power	1,500 W	1,500 W	1,500 W
No-load speed	6,600 /min	6,600 /min	6,600 /min
Revolutions at rated load	4,600 /min	4,600 /min	4,600 /min
Torque	14 Nm	14 Nm	14 Nm
Spindle threads	M 14	M 14	M 14
Weight (without mains cable)	5.8 kg	5.8 kg	5.8 kg
Cable length	4 m	4 m	4 m

Scope of delivery	606462 <sup>2)</sup>	606464	606465
Order no.	606462 <sup>2)</sup>	606464	606465
Guard	■	■	■
Inner support flange	■	■	■
Nut with two holes	■	■	■
Quick-locking nut	■	■	■
Metabo VibraTech (MVT) side handle	■	■	■
Flat-pin spanners	■	■	■

<sup>2)</sup> also available in 110 V (UK)

- Product advantages**
- Dead man switch for high user protection (optional)
  - Metabo Quick for tool-free disc change by means of a quick-locking nut
  - Starting current limitation prevents the actuation of the lock on start-up
  - Electronic safety shutdown: reduces kickback if the disc stops unexpectedly - for high user safety
  - Electronic overload protection and restart protection
  - LED signal indicates triggered restart protection or overheating
  - Metabo Marathon-motor with patented dust protection for long service life
  - Metabo safety switch prevents unintentional start
  - Tool-free adjustable guard; twist-proof
  - Metabo VibraTech (MVT): integrated damping system and side handle to reduce vibrations in order to protect the user's health
  - Side handle can be mounted in three positions
  - Rotating main handle: high safety and better handling when cutting
  - Auto-stop carbon brushes to protect the motor

System components

Accessories → 130





Ø 230 mm

Technical data	Angle Grinder W 24-230 MVT	Angle Grinder WE 24-230 MVT	Angle Grinder WE 24-230 MVT Quick	Angle Grinder WEA 24-230 MVT Quick
Grinding wheel Ø	230 mm	230 mm	230 mm	230 mm
Rated input power	2,400 W	2,400 W	2,400 W	2,400 W
Output power	1,600 W	1,600 W	1,600 W	1,600 W
No-load speed	6,600 /min	6,600 /min	6,600 /min	6,600 /min
Revolutions at rated load	4,600 /min	4,600 /min	4,600 /min	4,600 /min
Torque	17 Nm	17 Nm	17 Nm	17 Nm
Spindle threads	M 14	M 14	M 14	M 14
Weight (without mains cable)	5.8 kg	5.8 kg	5.8 kg	5.9 kg
Cable length	4 m	4 m	4 m	4 m

Scope of delivery	606467 <sup>1)</sup>	606469 <sup>2)</sup>	606470	606472
Guard	■	■	■	■
Inner support flange	■	■	■	■
Nut with two holes	■	■	■	■
Quick-locking nut			■	■
Metabo VibraTech (MVT) side handle	■	■	■	■
Flat-pin spanners	■	■		

<sup>1)</sup> also available in 120 V (North/Latin America)

<sup>2)</sup> also available in 110 V (UK)

**Product advantages**

- Dead man switch for high user protection (optional)
- Best anti-vibration system: integrated auto-balancer for up to 50% less hand-arm vibrations, longer service life of the machine and up to twice the service life of the grinding wheels
- Metabo Quick for tool-free disc change by means of a quick-locking nut
- Starting current limitation prevents the actuation of the lock on start-up
- Electronic safety shutdown: reduces kickback if the disc stops unexpectedly - for high user safety
- Electronic overload protection and restart protection
- LED signal indicates triggered restart protection or overheating
- Metabo Marathon-motor with patented dust protection for long service life
- Metabo safety switch prevents unintentional start
- Tool-free adjustable guard; twist-proof
- Metabo VibraTech (MVT): integrated damping system and side handle to reduce vibrations in order to protect the user's health
- Side handle can be mounted in three positions
- Rotating main handle: high safety and better handling when cutting
- Auto-stop carbon brushes to protect the motor

**System components**

Accessories → 130



Ø 230 mm

Technical data	Angle Grinder W 26-230 MVT	Angle Grinder WE 26-230 MVT Quick	Angle Grinder WEA 26-230 MVT Quick
Grinding wheel Ø	230 mm	230 mm	230 mm
Rated input power	2,600 W	2,600 W	2,600 W
Output power	1,800 W	1,800 W	1,800 W
No-load speed	6,600 /min	6,600 /min	6,600 /min
Revolutions at rated load	4,800 /min	4,800 /min	4,800 /min
Torque	18 Nm	18 Nm	18 Nm
Spindle threads	M 14	M 14	M 14
Weight (without mains cable)	6.3 kg	6.3 kg	6.4 kg
Cable length	4 m	4 m	4 m

Scope of delivery	606474 <sup>1)</sup>	606475	606476
Guard	■	■	■
Inner support flange	■	■	■
Nut with two holes	■	■	■
Quick-locking nut		■	■
Metabo VibraTech (MVT) side handle	■	■	■
Flat-pin spanners	■		

<sup>1)</sup> also available in 120 V (North/Latin America)

**Product advantages**

- Dead man switch for high user protection (optional)
- Best anti-vibration system: integrated auto-balancer for up to 50% less hand-arm vibrations, longer service life of the machine and up to twice the service life of the grinding wheels
- Starting current limitation prevents the actuation of the lock on start-up
- Electronic safety shutdown: reduces kickback if the disc stops unexpectedly - for high user safety
- Electronic overload protection and restart protection
- LED signal indicates triggered restart protection or overheating
- Metabo Quick for tool-free disc change by means of a quick-locking nut
- Metabo Marathon-motor with patented dust protection for long service life
- Metabo safety switch prevents unintentional start
- Tool-free adjustable guard; twist-proof
- Metabo VibraTech (MVT): integrated damping system and side handle to reduce vibrations in order to protect the user's health
- Side handle can be mounted in three positions
- Rotating main handle: high safety and better handling when cutting
- Auto-stop carbon brushes to protect the motor

**System components**

Accessories → 130

## Cutting and roughing discs: The Metabo quality classes at a glance.

Metabo offers you four quality grades, from which you can choose the right disc for your applications.

**»Novoflex«**  
**»Novorapid«** Inox

**Basic quality**

Impress with good cutting output and material removal with good tool life.

**»Flexiamant«**  
**»Flexiarapid«** Inox

**Standard quality**

Particularly uniform in cutting output and extraordinary tool life.

**»Flexiamant Super«**  
**»Flexiarapid Super«** Inox HydroResist

**Premium quality**

Extremely high cutting output with very long tool life

**»M-Calibur«**

**Premium CER quality**

Special ceramic abrasive grain technology and bonding for highest productivity and work progress

## Cutting and roughing discs: Powerful and robust.

The quality of cutting and roughing discs depends on several things: The grain (size, shape and quality of the abrasive grains), determines how powerful a disc is. The right ratio of bonding, filler materials and glass reinforcement determine how long the disc will last. Metabo cutting and roughing discs are manufactured in accordance with our recipes and quality specifications so that they, in combination with our machines, achieve best working results. The powerful discs permit an optimum working result in connection with long tool life and are therefore particularly economical.

**Metabo product line**  
Flexiamant super

**Dimension**  
230 x 2,5 x 22,23 mm  
9 x 3/32 x 7/8"

**Max. permitted speed**  
6.600 min<sup>-1</sup>  
max. 80 m/s

**Maximum working speed**

**Order number**  
616115

**Metal ring with expiry date**

**Clear information on the suitable materials**

**Specifications**  
See below

**Safety notes**

- Use ear defenders
- Use goggles
- Use dust mask
- Use protective gloves
- Limitations of usage

The Symbol of Safety

Metabo cutting and grinding accessories meet the highest safety standards, international standards and safety requirements such as EN 12413 and OSA

### The Metabo colour coding system

Metabo grinding wheels are colour coded according to their application area with the appropriate colour from the coding system. The catalogue carries the relevant colour bar on the left side of the grinding disc groups' table to help selection:

	Steel, sheet steel
	Stainless steel
	Aluminium, bronze, copper, brass, other NF metals
	Stone, concrete, tiles, clinker brick etc.
	Pipeline



### This is how to read the specification for a cutting and grinding disc:





<p><b>Specification</b> The combination of letters and numbers is the genetic code of the grinding wheel.</p> <p><b>Abrasive</b> A ■ For general processing of metal ZA ■ Special discs for metal processing</p> <p><b>C Silicon carbide</b> ■ For processing stone</p> <p><b>CA Ceramic</b> ■ Special discs for processing stainless steel and metal</p>	<p><b>Grit</b> The higher the number, the finer the grit. We use grain sizes of 16 – 60 for cutting and grinding discs: 16–24 Coarse 30–60 medium</p> <p><b>Hardness</b> The hardness of a grinding tool is coded alphabetically: ABC ... NOP ... RST ... Z Very soft Soft hard Very hard</p> <p><b>Shape</b> Shape 41: straight version Shape 42/27: offset version</p>	<p><b>Bonding</b> <b>B Resinoid bonding</b> ■ Permitted for a circumferential speed of up to 50 m/s <b>BF Glass-fibre reinforced resinoid bonding</b> ■ Permitted for a circumferential speed of up to 80 m/s</p> <p><b>Example: A 24-N-BF</b> A Aluminium Oxide 24 Grit N Hard disc BF Glass-fibre reinforced resinoid bonding ■ A disc of this type cuts well and has a good service life when working with steel.</p>
-------------------------------------------------------------------------------------------------------------------------------------------------------------------------------------------------------------------------------------------------------------------------------------------------------------------------------------------------------------------------------	----------------------------------------------------------------------------------------------------------------------------------------------------------------------------------------------------------------------------------------------------------------------------------------------------------------------------------------------------------------------------------------------------------	--------------------------------------------------------------------------------------------------------------------------------------------------------------------------------------------------------------------------------------------------------------------------------------------------------------------------------------------------------------------------------------------------------------------------------------------------------------



Cutting and Grinding Accessories

Cutting discs for hand-held angle grinders

Quality class	Diameter x thickness x bore mm	Version	Maximum speed /min	Sales unit / packing unit	Order no.
 <p><b>Quality class A 60-R / A 46 R »Novorapid« Steel</b></p> <ul style="list-style-type: none"> <li>Quality Novorapid: powerful entry-level class</li> <li>Thin cutting disc for general processing of metal, especially for thin-walled materials such as pipes, metal sheets, profiles, wires etc.</li> <li>Good cutting performance with good tool life.</li> <li>Hardness: medium-hard</li> <li>Low material consumption, power-saving, low machine load</li> <li>Maximum working speed: 80 m/s</li> </ul>					
A 60-R	115 x 1 x 22.23	—	13,300	1/25	616505000
A 60-R	125 x 1 x 22.23	—	12,200	1/25	616506000
A 46-R	150 x 1.6 x 22.23	—	10,200	1/25	616507000
A 46-R	180 x 1.6 x 22.23	—	8,500	1/25	616508000
A 46-R	230 x 1.9 x 22.23	—	6,600	1/25	616509000
 <p><b>Quality class A 30 »Novoflex« steel</b></p> <ul style="list-style-type: none"> <li>Quality Novoflex: powerful entry-level class</li> <li>Hardness: medium-hard</li> <li>Universal use in metal processing</li> <li>Good cutting performance with good tool life.</li> <li>Maximum working speed 80 m/s</li> </ul>					
A 30	100 x 2.5 x 16	—	15,300	1/25	616446000
A 30	100 x 2.5 x 16	—	15,300	1/25	616447000
A 30	115 x 2.5 x 22.23	—	13,300	1/25	616442000
A 30	115 x 2.5 x 22.23	—	13,300	1/25	616454000
A 30	115 x 3 x 22.23	—	13,300	1/25	616420000
A 30	125 x 2.5 x 22.23	—	12,200	1/25	616444000
A 30	125 x 2.5 x 22.23	—	12,200	1/25	616456000
A 30	150 x 3 x 22.23	—	10,200	1/25	616448000
A 30	180 x 3 x 22.23	—	8,500	1/25	616450000
A 30	180 x 3 x 22.23	—	8,500	1/25	616457000
A 30	230 x 3 x 22.23	—	6,600	1/25	616452000
A 30	230 x 3 x 22.23	—	6,600	1/25	616477000
 <p><b>Quality class A 30-R »Flexiamant« Steel</b></p> <ul style="list-style-type: none"> <li>Universal disc for complete metal processing</li> <li>Hardness: medium</li> <li>High cutting output with good tool life</li> <li>Uniform in cutting output and tool life</li> <li>Maximum working speed 80 m/s</li> </ul>					
A 30-R	100 x 2.5 x 16	—	15,300	1/25	616742000
A 30-R	115 x 2.5 x 22.23	—	13,300	1/25	616727000
A 30-R	115 x 2.5 x 22.23	—	13,300	1/25	616770000
A 30-R	125 x 2.5 x 22.23	—	12,200	1/25	616310000
A 30-R	125 x 2.5 x 22.23	—	12,200	1/25	616732000
A 30-R	150 x 3 x 22.23	—	10,200	1/25	616121000
A 30-R	150 x 3 x 22.23	—	10,200	1/25	616313000
A 30-R	180 x 3 x 22.23	—	8,500	1/25	616123000
A 30-R	180 x 3 x 22.23	—	8,500	1/25	616300000
A 30-R	230 x 3 x 22.23	—	6,600	1/25	616127000
A 30-R	230 x 3 x 22.23	—	6,600	1/25	616302000

Quality class	Diameter x thickness x bore mm	Version	Maximum speed /min	Sales unit / packing unit	Order no.
 <p><b>Quality class A 60-T / A 46-T »Flexiamant Super« steel</b></p> <ul style="list-style-type: none"> <li>Thin high output cutting disc especially for thin materials such as metal sheets, pipes, profiles, wires</li> <li>Hardness: hard</li> <li>Very high cutting output with good tool life</li> <li>Low material consumption, power-saving, low machine load</li> <li>Maximum working speed 80 m/s</li> </ul>					
A 60-T	115 x 1 x 22.23	—	13,300	1/25	616188000
A 46-T	115 x 1.6 x 22.23	—	13,300	1/25	616191000
A 60-T	125 x 1 x 22.23	—	12,200	1/25	616189000
A 46-T	125 x 1.6 x 22.23	—	12,200	1/25	616192000
 <p><b>Quality class A 36-T »Flexiamant Super« steel</b></p> <ul style="list-style-type: none"> <li>Universal disc for complete metal processing</li> <li>Hardness: hard</li> <li>Extremely high cutting output with good tool life by using special corundums</li> <li>Best results using powerful angle grinders</li> <li>Maximum working speed 80 m/s</li> </ul>					
A 36-T	115 x 2 x 22.23	—	13,300	1/25	616100000
A 36-T	115 x 2 x 22.23	—	13,300	1/25	616105000
A 36-T	115 x 3 x 22.23	—	13,300	1/25	616104000
A 36-T	125 x 2 x 22.23	—	12,200	1/25	616101000
A 36-T	125 x 2 x 22.23	—	12,200	1/25	616107000
A 36-T	150 x 2 x 22.23	—	10,200	1/25	616109000
A 36-T	150 x 2 x 22.23	—	10,200	1/25	616119000
A 36-T	180 x 2 x 22.23	—	8,500	1/25	616102000
A 36-T	180 x 2 x 22.23	—	8,500	1/25	616111000
A 36-T	230 x 2.5 x 22.23	—	6,600	1/25	616103000
A 36-T	230 x 2.5 x 22.23	—	6,600	1/25	616115000
 <p><b>Quality class A 46-T »Novorapid« Inox</b></p> <ul style="list-style-type: none"> <li>Quality Novorapid: powerful entry-level class</li> <li>Thin cutting disc for processing rust-free, thin-walled materials such as pipes, sheeting, profiles, wires etc. as well as for general metalworking</li> <li>Good cutting performance with good tool life.</li> <li>Hardness: hard</li> <li>Low material consumption, power-saving, low machine load</li> <li>Low in iron, sulphur and chlorine (Fe + S + Cl ≤ 0.1 %)</li> <li>Maximum working speed: 80 m/s</li> </ul>					
A 46-T	115 x 1 x 22.23	—	13,200	1/25	616270000
A 46-T	125 x 1 x 22.23	—	12,200	1/25	616271000
A 46-T Novorapid	180 x 1.5 x 22.23	—	8,600	1/25	616273000
A 46-T	230 x 1.9 x 22.23	—	6,600	1/25	616274000
 <p><b>Quality class A 30-P »Flexiamant« Inox</b></p> <ul style="list-style-type: none"> <li>Universal disc for processing stainless steels</li> <li>Hardness: soft</li> <li>High cutting output with good tool life</li> <li>Low in iron and sulphur &lt;0.1%</li> <li>Maximum working speed 80 m/s</li> </ul>					
A 30-P	100 x 2.5 x 16	—	15,300	1/25	616744000
A 30-P	115 x 2.5 x 22.23	—	13,300	1/25	616737000
A 30-P	115 x 3 x 22.23	—	13,300	1/25	616741000
A 30-P	125 x 2.5 x 22.23	—	12,200	1/25	616738000
A 30-P	180 x 3 x 22.23	—	8,500	1/25	616163000
A 30-P	180 x 3 x 22.23	—	8,500	1/25	616299000
A 30-P	230 x 3 x 22.23	—	6,600	1/25	616167000

Quality class	Diameter x thickness x bore mm	Version	Maximum speed /min	Sales unit / packing unit	Order no.
 <p><b>Quality class A 60-R / A 46-R / A 30-R »Flexiarapid« Inox</b></p> <ul style="list-style-type: none"> <li>Thin high-output cutting disc especially for stainless, thin-walled materials such as pipes, metal sheets, profiles, wires</li> <li>Hardness: hard</li> <li>Very high cutting output with good tool life by using special corundums</li> <li>Low material consumption, power-saving, low machine load.</li> <li>Low in iron, sulphur and chlorine (Fe + S + Cl ≤ 0.1 %)</li> <li>Maximum working speed 80 m/s</li> <li>A 60-R with 1 mm thickness; A 46-R with 1.6 mm thickness; A 30-R with 1.9 mm thickness</li> </ul>					
A 46-R	105 x 1.6 x 16	—	15,300	1/25	616180000
A 60-R	115 x 1 x 22.23	—	13,300	1/25	616186000
A 46-R	115 x 1.6 x 22.23	—	13,300	1/25	616181000
A 60-R	125 x 1 x 22.23	—	12,200	1/25	616187000
A 46-R	125 x 1.6 x 22.23	—	12,200	1/25	616182000
A 46-R	125 x 2 x 22.23	—	12,200	1/25	616179000
A 30-R	150 x 1.6 x 22.23	—	10,200	1/25	616183000
A 30-R	180 x 1.6 x 22.23	—	8,500	1/25	616184000
A 30-R	230 x 1.9 x 22.23	—	6,600	1/25	616185000





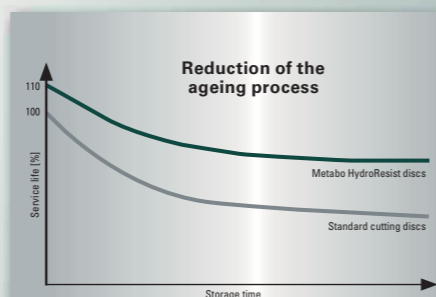

**New durable miracle: Flexiarapid Super/Combinator cutting discs with HydroResist formula**

Resin-bonded grinding wheels age and lose performance over the course of time - even if they are unused. The newly developed HydroResist formula counteracts this process and sustainably ensures the performance of the discs.

- More endurance:** increases the service life of the disc - even with high atmospheric humidity
- Less replacement costs:** 10% more cuts (per disc) by virtue of newly developed formula for optimised connection of grain and bonding agent





 <p><b>Quality class A 36-U / A 46-U / A 60-U »Flexiarapid Super« Inox HydroResist</b></p> <ul style="list-style-type: none"> <li>The super-thin high-output disc especially for processing stainless steel</li> <li>Super quick with very long service life thanks to the use of special corundums</li> <li>Low in iron, sulphur and chlorine (Fe + S + Cl ≤ 0.1 %)</li> <li>For all rust and acid resistant steels (V2A, Nirosta, INOX), spring steels, tool steels</li> <li>For use in the manufacture of vehicles, containers, car bodies, switch cabinets etc.</li> <li>Cutting discs for quiet, precise cutting, cuts without burrs</li> <li>Hardness: hard</li> <li>Maximum working speed 80 m/s</li> </ul>					
A 60-U	105 x 1 x 16	—	15,300	1/25	616210000
A 60-U	115 x 0.8 x 22.23	—	13,300	1/50	616208000
A 60-U	115 x 1 x 22.23	—	13,300	1/25	616216000
A 60-U	115 x 1 x 22.23	—	13,300	1/25	616217000
A 46-U	115 x 1.6 x 22.23	—	13,300	1/25	616218000
A 46-U	115 x 1.6 x 22.23	—	13,300	1/25	616219000
A 60-U	125 x 0.8 x 22.23	—	12,200	1/50	616209000
A 60-U	125 x 1 x 22.23	—	12,200	1/25	616220000
A 46-U	125 x 1.6 x 22.23	—	12,200	1/25	616222000
A 46-U	150 x 1.6 x 22.23	—	10,200	1/25	616224000
A 46-U	180 x 1.6 x 22.23	—	8,500	1/25	616226000
A 46-U	180 x 1.6 x 22.23	—	8,500	1/25	616227000
A 36-U	230 x 1.9 x 22.23	—	6,600	1/25	616228000
A 36-U	230 x 1.9 x 22.23	—	6,600	1/25	616229000

 <p><b>Quality class A 46-U »Combinator« Inox HydroResist</b></p> <ul style="list-style-type: none"> <li>One grinding wheel for two applications: quick cutting, and easy deburring and sanding</li> <li>All-purpose use for processing stainless steel and for general metal work</li> <li>Low in iron, sulphur and chlorine (Fe + S + Cl ≤ 0.1 %)</li> <li>Hardness: hard</li> <li>Reduces labour costs by saving on set-up time</li> <li>Eliminates time-consuming disc changes during mobile use.</li> <li>Highest standards in quality and safety thanks to the dimensional and lateral stability of the disc design (proven safety with 3 full-surface layers of material)</li> <li>Maximum working speed: 80 m/s</li> </ul>					
A 46-U Combinator Inox	115 x 1.9 x 22.23	—	13,200	1/25	616500000
A 46-U Combinator Inox	125 x 1.9 x 22.23	—	12,200	1/25	616501000
 <p><b>Quality class CA 46-U »M-Calibur« Inox</b></p> <ul style="list-style-type: none"> <li>The latest generation of cutting discs with ceramic abrasive grain</li> <li>Maximum cutting performance with extremely high tool life thanks to using ceramic special corundum and new bonding</li> <li>Highest productivity and work progress</li> <li>Low in iron, sulphur and chlorine (Fe + S + Cl ≤ 0.1 %)</li> <li>For all rust and acid resistant steels (V2A, Nirosta, INOX), high-alloy steels, spring steels, tool steels.</li> <li>Hardness: hard</li> <li>Maximum working speed 80 m/s</li> </ul>					
CA 46-U	115 x 1.6 x 22.23	—	13,300	1/25	616285000
CA 46-U	125 x 1.6 x 22.23	—	12,200	1/25	616286000
 <p><b>Quality class A 60-P / A 46 P »Flexiarapid« Alu</b></p> <ul style="list-style-type: none"> <li>Thin high-output cutting disc especially for processing aluminium, non-ferrous metals, copper, brass, bronze etc., thin-walled materials such as pipes, metal sheets, profiles, wires</li> <li>Hardness: medium-hard</li> <li>High cutting output with good tool life</li> <li>Maximum working speed 80 m/s</li> <li>Attention: Good extraction is obligatory in closed rooms, as highly concentrated aluminium dust can lead to explosions!</li> </ul>					
A 60-P	115 x 1 x 22.23	—	13,300	1/25	616512000
A 60-P	125 x 1 x 22.23	—	12,200	1/25	616513000
A 46 P	150 x 1.6 x 22.23	—	10,200	1/25	616514000
A 46 P	180 x 1.6 x 22.23	—	8,500	1/25	616515000
A 46 P	230 x 1.9 x 22.23	—	6,600	1/25	616516000
 <p><b>Quality class A 30-O »Flexiamant Super« Alu</b></p> <ul style="list-style-type: none"> <li>Universal disc with open structure for processing non-ferrous metals such as aluminium, copper, brass, bronze ...</li> <li>Hardness: soft</li> <li>High cutting output with good tool life</li> <li>Maximum working speed 80 m/s</li> <li>Attention: Good extraction is obligatory in closed rooms, as highly concentrated aluminium dust can lead to explosions!</li> </ul>					
A 30-O	115 x 2.5 x 22.23	—	13,300	1/25	616751000
A 30-O	125 x 2.5 x 22.23	—	12,200	1/25	616752000
A 30-O	150 x 3 x 22.23	—	10,200	1/25	616753000
A 30-O	180 x 3 x 22.23	—	8,500	1/25	616122000
A 30-O	230 x 3 x 22.23	—	6,600	1/25	616126000

	Quality class	Diameter x thickness x bore mm	Version	Maximum speed /min	Sales unit / packing unit	Order no.
	<b>Quality class C 30 »Novoflex« stone</b> <ul style="list-style-type: none"> <li>Quality Novoflex: powerful entry-level class</li> <li>Hardness: medium</li> <li>For universal use for processing natural and artificial stone</li> <li>Good cutting performance with good tool life.</li> <li>Maximum working speed 80 m/s</li> </ul>					
	C 30	115 x 2.5 x 22.23	—	13,300	1/25	616455000
	C 30	125 x 2.5 x 22.23	—	12,200	1/25	616428000
	C 30	150 x 3 x 22.23	—	10,200	1/25	616449000
	C 30	180 x 3 x 22.23	—	8,500	1/25	616458000
	C 30	230 x 3 x 22.23	—	6,600	1/25	616453000
	<b>Quality class C 30-S »Flexiamant Super« stone</b> <ul style="list-style-type: none"> <li>Universal disc for processing natural and artificial stone</li> <li>Hardness: medium</li> <li>High cutting output with good tool life</li> <li>Maximum working speed 80 m/s</li> </ul>					
	C 30-S	115 x 2.5 x 22.23	—	13,300	1/25	616728000
	C 30-S	125 x 2.5 x 22.23	—	12,200	1/25	616312000
	C 30-S	125 x 2.5 x 22.23	—	12,200	1/25	616733000
	C 30-S	180 x 3 x 22.23	—	8,500	1/25	616143000
	C 30-S	230 x 3 x 22.23	—	6,600	1/25	616147000
	<b>Quality class C 60-T »Flexiamant Super« stone</b> <ul style="list-style-type: none"> <li>Super thin special disc for processing tiles, ceramics, clinkers etc.</li> <li>Hardness: hard</li> <li>Very high cutting output with above average tool life</li> <li>Quick cutting time, less cutting wastage, cleaner cutting edges</li> <li>Maximum working speed 80 m/s</li> </ul>					
	C 60-T	115 x 1.5 x 22.23	—	13,300	1/25	616195000
	C 60-T	125 x 1.5 x 22.23	—	12,200	1/25	616196000



Cutting discs for cutting machines/petrol cutters

	Quality class	Diameter x thickness x bore mm	Version	Maximum speed /min	Sales unit / packing unit	Order no.
	<b>Quality class A 24-N »Flexiamant Super« steel</b> <ul style="list-style-type: none"> <li>For use in all steel processing applications, also for cast materials</li> <li>Hardness: medium</li> <li>High cutting output with good tool life</li> <li>Maximum working speed 80 m/s</li> <li>Cutting discs with 3 inside fabrics due to the increased side load with gasoline cutters</li> </ul>					
	A 24-N	300 x 3.5 x 20	—	5,090	1/10	616136000
	A 24-N	300 x 3.5 x 22.2	—	5,090	1/10	616135000
	A 24-N	300 x 3.5 x 25.4	—	5,090	1/10	616137000
	<b>Quality class C 24-N »Flexiamant Super« stone</b> <ul style="list-style-type: none"> <li>For processing natural and artificial stone, non-ferrous metals</li> <li>Hardness: medium</li> <li>High cutting output with good tool life</li> <li>Maximum working speed 80 m/s</li> <li>Cutting discs with 3 inside fabrics due to the increased side load with gasoline cutters</li> </ul>					
	C 24-N	300 x 3.5 x 20	—	5,090	1/10	616156000
	C 24-N	300 x 3.5 x 22.23	—	5,090	1/10	616155000

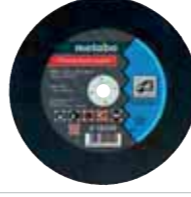
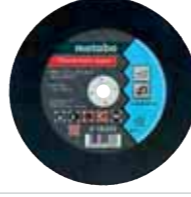



Cutting discs for table-top cutting machines

	Quality class	Diameter x thickness x bore mm	Version	Maximum speed /min	Sales unit / packing unit	Order no.
	<b>Quality class A 30-R / A 36-S »Flexiamant Super« steel</b> <ul style="list-style-type: none"> <li>Good cutting output with good tool life in steel</li> <li>Tough version for powerful machines (machine load &gt; 3 KW)</li> <li>A 36-S: with an inside gauze for quick cuts</li> <li>Maximum working speed 80 m/s</li> </ul>					
	A 30-R	300 x 2.5 x 25.4	—	5,090	1/10	616328000
	A 30-R	350 x 3 x 25.4	—	4,365	1/10	616327000
	<b>Quality class A 24-M »Flexiamant Super« Steel</b> <ul style="list-style-type: none"> <li>High cutting output with good tool life in steel</li> <li>Soft version for less powerful machines (machine load &lt;3 KW)</li> <li>Maximum working speed 80 m/s</li> </ul>					
	A 24-M	350 x 3 x 25.4	—	4,365	1/10	616338000
	A 24-M	400 x 3 x 25.4	—	3,820	1/10	616215000
	<b>Quality class A 36-R »Flexiamant Super« Inox</b> <ul style="list-style-type: none"> <li>Medium-hard special cutting disc for stainless steel</li> <li>High cutting output with good tool life</li> <li>Low in iron and sulphur &lt;0.1%</li> <li>Maximum working speed 80 m/s</li> <li>Medium hard version for less powerful machines (machine load &lt;3 KW)</li> </ul>					
	A 36-R	350 x 3 x 25.4	—	4,365	1/10	616343000

Cutting discs for stationary cutting machines

	Quality class	Diameter x thickness x bore mm	Version	Maximum speed /min	Sales unit / packing unit	Order no.
	<b>Quality class A 30-S »Flexiamant Super« steel</b> <ul style="list-style-type: none"> <li>Universal use in metal processing</li> <li>Hardness: hard</li> <li>High cutting output with good tool life</li> <li>Maximum working speed 100 m/s</li> <li>For powerful machines (machine load &gt; 5 KW)</li> </ul>					
	A 30-S	300 x 3 x 25.4	—	6,365	1/10	616202000
	A 30-S	350 x 3.5 x 25.4	—	5,460	1/10	616203000
	A 30-S	400 x 4 x 25.4	—	4,775	1/10	616204000
	A 30-S	350 x 4 x 22.23	—	5,460	1/10	616201000
	<b>Quality class C 30-S »Flexiamant Super« stone</b> <ul style="list-style-type: none"> <li>Universal use for processing natural and artificial stone</li> <li>Also suitable for processing non-ferrous metals</li> <li>Hardness: hard</li> <li>High cutting output with good tool life</li> <li>Maximum working speed 100 m/s</li> <li>For powerful machines (machine load &gt; 5 KW)</li> </ul>					
	C 30-S	300 x 3 x 25.4	—	6,365	1/10	616212000
	C 30-S	350 x 3.5 x 25.4	—	5,460	1/10	616213000





Quality class	Diameter x thickness x bore mm	Version	Maximum speed /min	Sales unit / packing unit	Order no.	
 <p><b>Quality class ZA 24-T »Flexiamant Super« cast</b></p> <ul style="list-style-type: none"> <li>Especially for processing different cast materials</li> <li>Suitable for surface grinding, processing of weld seams, chamfering, deburring, etc.</li> <li>Abrasive grain: Zirconia alumina</li> <li>Hardness: hard</li> <li>Very high material removal with good tool life</li> <li>Maximum working speed 80 m/s</li> </ul>	ZA 24-T	115 x 7 x 22.23		13,300	1/10	616517000
	ZA 24-T	125 x 7 x 22.23		12,200	1/10	616518000
	ZA 24-T	180 x 7 x 22.23		8,500	1/10	616519000

Cup wheels, tapered

Diameter x thickness x bore mm	Maximum speed /min	Sales unit / packing unit	Order no.	
 <p><b>Quality class A 16-Q</b></p> <ul style="list-style-type: none"> <li>Surface grind across the entire metal processing sector with angle grinders</li> <li>Hardness: hard</li> <li>Resin-bonded</li> <li>Good material removal with good tool life</li> <li>Maximum working speed 50 m/s</li> <li>For angle grinders with grinding wheel Ø 180 mm and 230 mm</li> </ul>	110 x 55 x 22.23	8,600	1/6	616170000
	110 x 55 x 22.23	8,600	1/1	630725000*
	 <p><b>Quality class C 16-N</b></p> <ul style="list-style-type: none"> <li>For rough work, even for cast iron</li> <li>Resin-bonded</li> <li>Good material removal with good tool life</li> <li>Surface grinding across the entire stone processing sector</li> <li>Also suitable for cast iron materials and non-ferrous metals</li> <li>Maximum working speed 50 m/s</li> <li>For angle grinders with grinding wheel Ø 180 mm and 230 mm</li> <li>Hardness: medium-hard</li> </ul>	110 x 55 x 22.23	8,600	1/6
110 x 55 x 22.23		8,600	1/1	630726000*
 <p><b>Quality class C 36-M</b></p> <ul style="list-style-type: none"> <li>For general tasks</li> <li>Resin-bonded</li> <li>Good material removal with good tool life</li> <li>Surface grinding across the entire stone processing sector</li> <li>Also suitable for cast iron materials and non-ferrous metals</li> <li>Maximum working speed 50 m/s</li> <li>For angle grinders with grinding wheel Ø 180 mm and 230 mm</li> <li>Hardness: medium-hard</li> </ul>		110 x 55 x 22.23	8,600	1/6

Cup wheels, cylindrical

Diameter x thickness x bore mm	Maximum speed /min	Sales unit / packing unit	Order no.	
 <p><b>Quality class A 80-M steel</b></p> <ul style="list-style-type: none"> <li>Surface grinding for all metal processing needs</li> <li>Hardness: medium</li> <li>Resin-bonded</li> <li>Good material removal with good tool life</li> <li>Only for dry sanding/grinding</li> <li>Maximum working speed 50 m/s</li> <li>For angle grinders with grinding wheel Ø 115 mm, 125 mm and 150 mm</li> </ul>	80 x 25 x 22.23	11,940	1/20	629174800
	80 x 25 x 22.23	11,940	1/1	630727000*
	 <p><b>Quality class C 30-N stone</b></p> <ul style="list-style-type: none"> <li>Surface grinding for all stone processing applications</li> <li>Hardness: medium</li> <li>Resin-bonded</li> <li>Good material removal with good tool life</li> <li>Only for dry sanding/grinding</li> <li>Maximum working speed 50 m/s</li> <li>For angle grinders with grinding wheel Ø 115 mm, 125 mm and 150 mm</li> </ul>	80 x 25 x 22.23	11,940	1/20
80 x 25 x 22.23		11,940	1/1	630728000*

\* Self-service packaging



Flap discs and fibre discs with ceramic grain



The Metabo Convex flap discs.



- **Extremely long tool life** with high-grade ceramic grain
- Extremely high material removal with low effort
- **Uniform material removal across the entire service life** with self-sharpening ceramic grain
- **Good bonding of the ceramic grain on the carrier material**
- **Grind-active additional layer**
- **Cool grinding on surfaces and edges**
- **Fields of application;**  
Processing of sheet metal, container construction, die-cast parts, pipes, bars, metal, stainless steel, high-alloy steels, titanium alloy, chrome-nickel steel, brass, bronze etc.

Ideal also for extreme grinding jobs

- **The ideal shape for fillet welds**  
Achieve the optimum finish faster
- **Extremely long tool life**  
thanks to high-quality ceramic grit and/or zirconia alumina
- **Extremely high and fast material removal**  
thanks to high-quality ceramic grit and/or zirconia alumina
- **Faster and more efficient work results**  
thanks to the design which is ideally adapted to fillet welds, also suitable for surface grinding
- **Particularly long service life**  
thanks to the use of ceramic grit and/or zirconia alumina and the high number of lamellae
- **Specially shaped flap disc**  
with lamellae that are rounded off towards the outer edges,  
→ suitable for all angle grinders



- **Maximum working speed 80 m/s**

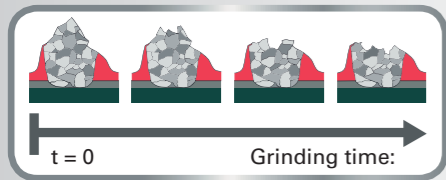



In the ceramic grit, fine aluminium oxide (Al<sub>2</sub>O<sub>3</sub>) crystals are bonded to each other by means of a sintering process. The grinding forces cause the micro crystals to break off during the grinding process so that the grinding grit always gets new, sharp cutting edges.



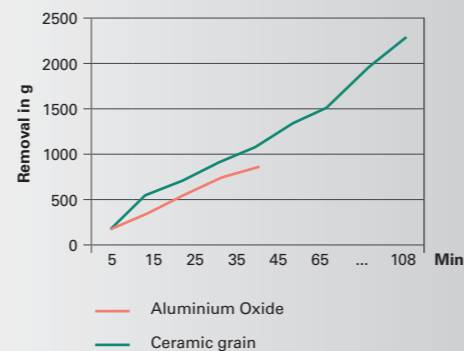







	Removed material after the end of the grinding time
Aluminium Oxide	890.0 g
Ceramic grain	2295.0 g

A ceramic grit fibre disc manages 2.5 times the removal of an aluminium oxide disc



Flap discs







	Diameter x bore mm	Grit	Version	Maximum speed /min	Sales unit / packing unit	Order no.
 <p><b>Quality class aluminium oxide »Flexiamant«</b></p> <ul style="list-style-type: none"> <li>■ Suitable for rough and intermediate grinding of steel, non-ferrous metals, wood and plastics</li> <li>■ High lamellar lining on fibreglass plate</li> <li>■ Uniform grinding capacity</li> <li>■ Cool grinding</li> <li>■ Low noise level</li> <li>■ Uniform grinding result, comfortable grinding with only low vibration</li> <li>■ Maximum working speed 80 m/s</li> <li>■ Tilted version: angle of attack 7-9°</li> </ul>	115 x 22.23	P 40	⌒	13,300	1/10	624391000
	115 x 22.23	P 60	⌒	13,300	1/10	624392000
	115 x 22.23	P 80	⌒	13,300	1/10	624393000
	115 x 22.23	P 120	⌒	13,300	1/10	624394000
	125 x 22.23	P 40	⌒	12,200	1/10	624395000
	125 x 22.23	P 60	⌒	12,200	1/10	624396000
	125 x 22.23	P 80	⌒	12,200	1/10	624397000
	125 x 22.23	P 120	⌒	13,300	1/10	624398000
 <p><b>Quality class zirconia alumina »Novoflex«</b></p> <ul style="list-style-type: none"> <li>■ Suitable for rough and intermediate grinding in all fields of metalworking including stainless steel, steel, cast iron, and sheet steel</li> <li>■ Quality »Novoflex«: powerful entry-level class</li> <li>■ Uniform grinding capacity</li> <li>■ Cool grinding</li> <li>■ Uniform grinding result, comfortable grinding with only low vibration</li> <li>■ Most suitable for processing stainless steels</li> <li>■ Maximum working speed 80 m/s</li> <li>■ Tilted version: angle of attack 7-9°</li> </ul>	115 x 22.23	P 40	⌒	13,300	1/10	623175000
	115 x 22.23	P 60	⌒	13,300	1/10	623176000
	115 x 22.23	P 80	⌒	13,300	1/10	623177000
	115 x 22.23	P 120	⌒	13,300	1/10	623178000
	125 x 22.23	P 40	⌒	12,200	1/10	623195000
	125 x 22.23	P 60	⌒	12,200	1/10	623196000
	125 x 22.23	P 80	⌒	12,200	1/10	623197000
	125 x 22.23	P 120	⌒	12,200	1/10	623198000
	178 x 22.23	P 40	⌒	8,500	1/10	623112000
	178 x 22.23	P 60	⌒	8,500	1/10	623114000
178 x 22.23	P 80	⌒	8,500	1/10	623115000	
 <p><b>Quality class zirconia alumina »Flexiamant«</b></p> <ul style="list-style-type: none"> <li>■ Suitable for rough and intermediate grinding in all fields of metalworking including stainless steel, steel, cast iron, and sheet steel</li> <li>■ High lamellar lining on fibreglass plate</li> <li>■ Uniform grinding capacity</li> <li>■ Cool grinding</li> <li>■ Low noise level</li> <li>■ Uniform grinding result, comfortable grinding with only low vibration</li> <li>■ Most suitable for processing stainless steels</li> <li>■ Maximum working speed 80 m/s; tilted version: angle of attack 7-9°</li> </ul>	115 x 22.23	P 40	⌒	13,300	1/10	624241000
	115 x 22.23	P 60	⌒	13,300	1/10	624243000
	115 x 22.23	P 80	⌒	13,300	1/10	624244000
	115 x 22.23	P 120	⌒	13,300	1/10	624239000
	125 x 22.23	P 40	⌒	12,200	1/10	624275000
	125 x 22.23	P 60	⌒	12,200	1/10	624277000
	125 x 22.23	P 80	⌒	12,200	1/10	624278000
	125 x 22.23	P 120	⌒	12,200	1/10	624279000
	178 x 22.23	P 40	⌒	8,500	1/10	624256000
	178 x 22.23	P 60	⌒	8,500	1/10	624258000
178 x 22.23	P 80	⌒	8,500	1/10	624259000	

	Diameter x bore mm	Grit	Version	Maximum speed /min	Sales unit / packing unit	Order no.
	178 x 22.23	P 120		8,500	1/10	624276000
	115 x 22.23	P 40		13,300	1/10	624246000
	115 x 22.23	P 60		13,300	1/10	624247000
	115 x 22.23	P 80		13,300	1/10	624248000
	125 x 22.23	P 40		12,200	1/10	624475000
	125 x 22.23	P 60		12,200	1/10	624477000
	125 x 22.23	P 80		12,200	1/10	624478000
	178 x 22.23	P 40		8,500	1/10	624356000
	178 x 22.23	P 60		8,500	1/10	624358000
	178 x 22.23	P 80		8,500	1/10	624359000



**Quality class ceramic »Flexiamant Super«**







- Extremely high material removal with little effort thanks to the self-sharpening ceramic grain.
- Excellent results for surface and edge grinding of steel and stainless steel. Ideal for extreme grinding jobs like processing high-alloy steels, titanium alloys, nickel-based alloys as well as chromium and chromium-nickel steels, brass and bronze thanks to high load capacity.
- Very high tool life; cool grinding on surfaces and edges
- Uniform grinding result, comfortable grinding with only low vibration
- Maximum working speed 80 m/s
- Tilted version: angle of attack 7-9°

	115 x 22.23	P 40		13,300	1/10	626166000
	115 x 22.23	P 60		13,300	1/10	626167000
	115 x 22.23	P 80		13,300	1/10	626168000
	125 x 22.23	P 40		12,200	1/10	626169000
	125 x 22.23	P 60		12,200	1/10	626170000
	125 x 22.23	P 80		12,200	1/10	626171000



**Quality class zirconia alumina »Flexiamant Convex«**





- Specially shaped flap disc with lamellae that are rounded off towards the outer edges.
- Grinding media: Zirconia alumina
- Thanks to the special design it is particularly suited for processing fillet welds; making faster and more efficient processing possible; also suitable for surface grinding
- High material removal with very high tool life thanks to the use of zirconia alumina
- Suitable for processing stainless steel and steel
- Uniform grinding result, comfortable grinding with only low vibration
- Maximum working speed 80 m/s

	125 x 22.23	P 40		12,200	1/10	626462000
	125 x 22.23	P 60		12,200	1/10	626463000
	125 x 22.23	P 80		12,200	1/10	626464000
	150 x 22.23	P 40		10,200	1/10	626490000
	150 x 22.23	P 60		10,200	1/10	626491000
	150 x 22.23	P 80		10,200	1/10	626492000



**Quality class ceramic »Flexiamant Super Convex«**

- Specially shaped flap disc with lamellae that are rounded off towards the outer edges.
- Thanks to the special design it is particularly suited for processing fillet welds; making faster and more efficient processing possible; also suitable for surface grinding
- Very high material removal with very high tool life thanks to the use of ceramic grain.
- Cool cut for materials with poor thermal conduction
- For grinding of steel and stainless steel. Ideal for extreme grinding jobs like processing high-alloy steels, titanium alloys, nickel-based alloys as well as chromium and chromium-nickel steels, brass and bronze thanks to high load capacity.
- Uniform grinding result, comfortable grinding with only low vibration
- Maximum working speed 80 m/s

	125 x 22.23	P 60		12,200	1/10	626460000
	125 x 22.23	P 80		12,200	1/10	626461000
	150 x 22.23	P 60		10,200	1/10	626488000
	150 x 22.23	P 80		10,200	1/10	626489000

**Combination flap discs - KLS**



- Made from high-quality pink aluminium oxide fabric in combination with high-quality nylon web.
- For removal of material to fine polish in a single process. Very even grinding/polishing result with good material removal.
- For processing weld seams for example, and for grinding or polishing. For removing minor scratches and damage to the work piece.
- Suitable for grinding, cleaning and finishing work on stainless steel, steel, coloured and light metals, titanium alloys.
- Maximum working speed: 80 m/s
- Recommended speed: 3,000 /min

Diameter x bore mm	Grit	Sales unit / packing unit	Order no.
125 x 22.23	Coarse	1 / 1	626369000*
125 x 22.23	Coarse	1 / 5	626415000
125 x 22.23	medium	1 / 1	626370000*
125 x 22.23	medium	1 / 5	626416000

**Fleece compact polishing discs »Unitized« - VKS**



- Made of compacted fleece material on a fibreglass backing pad
- For cleaning and polishing surfaces, for smoothing weld seams; reduces the number of working stages required
- For alloy and high-alloy steels, coloured and light metals, chrome and nickel steels, titanium, steels
- Max. torque: 8,000 /min; 52 m/s
- Recommended speed: 3,000 /min

Diameter x thickness x bore mm	Grit	Sales unit / packing unit	Order no.
125 x 22.23	Very fine	1 / 1	626368000*
125 x 22.23	Very fine	1 / 5	626417000

**Fleece compact grinding discs »Unitized« - VKS-ZK**







- Several layers of pressed fleece material, soaked with resin-bonded abrasive grain (zirconia alumina)
- The addition of abrasive grain covers a range of applications from deburring to soft and flexible finishing jobs. It is suited for deburring, smoothing of weld seams, precise cleaning and finishing of surfaces.
- For alloy and high-alloy steels, coloured and light metals, chrome and nickel steels, titanium, steels
- Profiling of the grinding media possible for precise working. Very low roughing of the processed material.
- Bore 22.23 mm (for angle grinder)
- Max. 10,000/min; recommended speed: 3,000/min

Diameter x thickness x bore mm	Grit	Sales unit / packing unit	Order no.
125 x 6 x 22.23	Coarse	1 / 5	626482000
125 x 6 x 22.23	medium	1 / 5	626483000

\* Self-service packaging

Flap wheels

Diameter mm	Thickness mm	Female thread	Grit	Version	Maximum speed /min	Sales unit / packing unit	Order no.
 <p><b>Quality class ceramic »Flexiamant Super«</b></p> <ul style="list-style-type: none"> <li>Flap wheel with straight profiled lamellae, particularly suited for processing fillet welds. The profiled lamellae, arranged radially in the shape of a fan, adapt exceptionally well to the contours of the work piece. Ideally suited for an even and smooth weld seam. Thanks to the offset shape it can also be used at hard to reach places.</li> <li>High material removal with high tool life thanks to the use of ceramic grain.</li> <li>Excellent results for surface and edge grinding of steel and stainless steel. Ideal for extreme grinding jobs like processing high-alloy steels, titanium alloys, nickel-based alloys as well as chromium and chromium-nickel steels, brass and bronze thanks to high load capacity.</li> <li>Cool cut for materials with poor thermal conduction</li> <li>Maximum speed: 10,000 rpm</li> </ul>							
125	8	M 14	P 40		10,000	1/5	626470000
125	8	M 14	P 60		10,000	1/5	626471000
125	8	5/8 "	P 40		10,000	1/5	626486000
125	8	5/8 "	P 60		10,000	1/5	626487000

Hook and loop backing pads »Metabo Pyramid«

 <ul style="list-style-type: none"> <li>Hook and loop, with flexible intermediate layer, foam-moulded; for attaching polishing and sanding accessories</li> <li>Sanding pad for polishing and medium-hard grinding jobs. Especially recommended for Metabo Pyramid hook and loop sanding sheets</li> </ul>							
Female thread	Diameter mm	Thickness mm	Sales unit	Order no.			
5/8 "	123	3	1	623298000*			
M 14	123	3	1	623300000*			

»Metabo Pyramid« hook and loop sanding sheets

 <ul style="list-style-type: none"> <li>3-dimensional structure of the grinding media (pyramid-shaped).</li> <li>High material removal with, at the same time, a very even and fine grinding result. Long service life. Faster progress when compared to tradition grinding media thanks to the considerable reduction in the number of working stages.</li> <li>For removing scratches, mill skin on stainless steel. Preparation for polishing.</li> <li>Suitable for use throughout the metal industry; especially for stainless steels, titanium, cobalt, nickel, chrome alloys.</li> </ul>							
Diameter mm	Grit	Sales unit / packing unit	Order no.				
125	P 120 (A 160)	1 / 5	626371000*				
125	P 280 (A 65)	1 / 5	626372000*				
125	P 400 (A 45)	1 / 5	626373000*				
125	P 600 (A 30)	1 / 5	626374000*				
125	P 1200 (A 16)	1 / 5	626403000*				
125	P 2000 (A 6)	1 / 5	626404000*				

Hook and loop fleece compact discs »Unitized« - VKS

 <ul style="list-style-type: none"> <li>Made from pressed fleece material with hook and loop</li> <li>For cleaning and polishing surfaces, for smoothing weld seams; reduces the number of working stages required</li> <li>For alloy and high-alloy steels, coloured and light metals, chrome and nickel steels, titanium, steels</li> </ul>							
Diameter x bore mm	Grit	Sales unit / packing unit	Order no.				
125	Very fine	1 / 1	626375000*				

Cleaning fleeces

 <ul style="list-style-type: none"> <li>For the removal of light rust, paint / varnish on metal, cleaning weld seams / steel / copper / aluminium / brass, sanding steel and texturing wood.</li> <li>Maximum working speed: 63 m/s</li> <li>Recommended speeds at Ø 115 mm: 2,900 /min, Ø 125 mm: 2,700 /min</li> </ul>							
Diameter x bore mm	Sales unit	Order no.					
115 x 22.23	1	624346000*					
125 x 22.23	1	624347000*					

Semi-flexible sanding sheets

 <p><b>Semi-flexible sanding sheets</b></p> <ul style="list-style-type: none"> <li>Suitable for use on masonry and stone work</li> <li>Grinding media: SiC (silicone carbide); maximum working speed: 80/s</li> <li>For use with the elastic backing pad 623279000</li> <li>Diameter: 115 mm</li> <li>Grit: C 24</li> <li>Material suitability: stone</li> <li>Sales unit: 1</li> </ul>							
Order no.	624873000						

Fibre sanding discs

Diameter x bore mm	Grit	Maximum speed /min	Sales unit / packing unit	Order no.
 <p><b>Aluminium oxide, hole type: round hole, slotted</b></p> <ul style="list-style-type: none"> <li>Suitable for use throughout the metal industry</li> <li>For rough and fine grinding jobs</li> <li>Processing weld joints, removing rust, deburring</li> <li>High material removal with good tool life</li> <li>Even grinding result</li> <li>Maximum working speed 80 m/s</li> <li>Fibre discs for clamping on backing pad!</li> </ul>				
100 x 16	P 24	15,300	1/25	624094000
115 x 22.23	P 16	13,300	1/25	624135000
115 x 22.23	P 24	13,300	1/25	624136000
115 x 22.23	P 36	13,300	1/25	624145000
115 x 22.23	P 40	13,300	1/25	624137000
115 x 22.23	P 50	13,300	1/25	624144000
115 x 22.23	P 60	13,300	1/25	624138000
115 x 22.23	P 80	13,300	1/25	624139000
115 x 22.23	P 100	13,300	1/25	624140000
115 x 22.23	P 120	13,300	1/25	624141000
115 x 22.23	P 150	13,300	1/25	624142000
115 x 22.23	P 180	13,300	1/25	624143000
125 x 22.23	P 16	12,200	1/25	624223000
125 x 22.23	P 24	12,200	1/25	624218000
125 x 22.23	P 36	12,200	1/25	624216000
125 x 22.23	P 40	12,200	1/25	624219000
125 x 22.23	P 50	12,200	1/25	624217000
125 x 22.23	P 60	12,200	1/25	624220000
125 x 22.23	P 80	12,200	1/25	624221000
125 x 22.23	P 100	12,200	1/25	624222000
125 x 22.23	P 120	12,200	1/25	624224000
125 x 22.23	P 150	12,200	1/25	624225000
125 x 22.23	P 180	12,200	1/25	624226000
180 x 22.23	P 16	8,500	1/25	624123000
180 x 22.23	P 24	8,500	1/25	624103000

\* Self-service packaging

Diameter x bore mm	Grit	Maximum speed /min	Sales unit / packing unit	Order no.
180 x 22.23	P 30	8,500	1/25	624124000
180 x 22.23	P 36	8,500	1/25	624122000
180 x 22.23	P 40	8,500	1/25	624104000
180 x 22.23	P 50	8,500	1/25	624102000
180 x 22.23	P 60	8,500	1/25	624105000
180 x 22.23	P 80	8,500	1/25	624106000
180 x 22.23	P 100	8,500	1/25	624107000
180 x 22.23	P 120	8,500	1/25	624101000
230 x 22.23	P 24	6,600	1/25	624227000
230 x 22.23	P 40	6,600	1/25	624228000



**Zirconia alumina, hole type: round hole, slotted**

- Suitable for use throughout the metal industry
- For rough and fine grinding jobs
- Especially for processing stainless steel
- High material removal with good tool life
- Even grinding result
- Maximum working speed 80 m/s
- Fibre discs for clamping on backing pad!

115 x 22.23	P 36	13,300	1/25	622971000
115 x 22.23	P 40	13,300	1/25	622972000
115 x 22.23	P 50	13,300	1/25	622973000
115 x 22.23	P 60	13,300	1/25	622974000
115 x 22.23	P 80	13,300	1/25	622975000
115 x 22.23	P 100	13,300	1/25	622976000
115 x 22.23	P 120	13,300	1/25	622977000
125 x 22.23	P 36	12,200	1/25	622981000
125 x 22.23	P 40	12,200	1/25	622982000
125 x 22.23	P 60	12,200	1/25	622984000
125 x 22.23	P 80	12,200	1/25	622985000
125 x 22.23	P 100	12,200	1/25	622986000
125 x 22.23	P 120	12,200	1/25	622987000
180 x 22.23	P 36	8,500	1/25	622991000
180 x 22.23	P 40	8,500	1/25	622992000
180 x 22.23	P 60	8,500	1/25	622994000
180 x 22.23	P 80	8,500	1/25	622995000
180 x 22.23	P 100	8,500	1/25	622996000
180 x 22.23	P 120	8,500	1/25	622997000



**Ceramics, hole type: round hole, slotted**

- Self-sharpening ceramic grain for extremely high material removal with little effort
- Excellent results for surface grinding of steel and stainless steel. Ideal for extreme grinding jobs such as processing high-alloy steels, titanium alloys, nickel-based alloys as well as chromium and chromium-nickel steels, brass and bronze, thanks to high load capacity.
- Very high tool life; cool grinding
- Ceramic filter discs achieve their best performance on powerful angle grinders with increased down pressure.
- Fibre discs for clamping on backing pad! The backing pads with cooling ribs are recommended for clamping the ceramic fibre discs (e.g. Ø 125 mm, 623291000)
- Maximum working speed 80 m/s

115 x 22.23	P 24	13,300	1/25	626150000
115 x 22.23	P 36	13,300	1/25	626151000
115 x 22.23	P 60	13,300	1/25	626152000
115 x 22.23	P 80	13,300	1/25	626153000
125 x 22.23	P 24	12,200	1/25	626154000
125 x 22.23	P 36	12,200	1/25	626155000
125 x 22.23	P 60	12,200	1/25	626156000
125 x 22.23	P 80	12,200	1/25	626157000
180 x 22.23	P 24	8,500	1/25	626158000
180 x 22.23	P 36	8,500	1/25	626159000
180 x 22.23	P 60	8,500	1/25	626160000
180 x 22.23	P 80	8,500	1/25	626161000

**Backing Pads for Fibre Sanding Discs**

**Backing pads, standard**



- Standard version for medium to rough grinding work
- For use with fibre sanding discs
- All pads with flange nut
- Maximum working speed 80 m/s
- 626418000: Special version with longer clamping nut for use on Metabo angle grinders with Autobalancer / brake

Diameter mm	Flange nut	Maximum speed /min	Sales unit / packing unit	Order no.
112	M 14	13,300	1/1	623279000*
122	M 14	12,200	1/1	623278000*
122	M 14	12,200	1/1	626418000*
175	M 14	8,500	1/1	623275000*
220	M 14	6,600	1/1	623280000*
112	5/8 "	13,300	1/1	623283000*
122	5/8 "	12,200	1/1	623284000*
175	5/8 "	8,500	1/1	623281000*
220	5/8 "	6,600	1/1	623282000*

**Backing pads with cooling fins**



- For use with fibre sanding discs
- Backing pads with cooling fins are mainly used for all coarse grinding jobs. Also suitable for processing stainless steel. The cooling fins run radially on the grinding surface reducing overheating of workpiece and backing pad
- All pads with flange nut
- Maximum working speed 80 m/s

Diameter mm	Flange nut	Maximum speed /min	Sales unit / packing unit	Order no.
112	M 14	13,300	1/1	623290000*
122	M 14	12,200	1/1	623291000*
175	M 14	8,500	1/1	623292000*

**Steel-wire Brushes**

**Steel-wire cup brushes, twisted steel**



- For universal use in metal processing, e.g. for cleaning, deburring, purging, removing rust, smoothing welding seams and points, stripping slag, scales and old paint
- For processing large areas, weld seams etc.
- Edging type: twisted steel wire

Diameter mm	Female thread	Wire thickness	Maximum speed /min	Sales unit / packing unit	Order no.
65	M 14	0.35 mm	11,000	1/1	623796000*
65	M 14	0.35 mm	11,000	1/50	623796700
65	5/8 "	0.50 mm	11,000	1/1	623804000*
80	M 14	0.50 mm	8,600	1/1	623710000*
100	M 14	0.50 mm	8,600	1/1	623711000*

\* Self-service packaging

Steel-wire cup brushes, stainless steel, twisted



- For universal use in stainless steel processing, e.g. for smoothing welding seams and points, stripping slag, scales and old paint. Ideally suited for processing stainless steels
- Edging type: twisted stainless steel wire

Diameter mm	Female thread	Wire thickness	Maximum speed /min	Sales unit / packing unit	Order no.
65	M 14	0.35 mm	11,000	1/1	623801000*
65	5/8 "	0.35 mm	11,000	1/1	623805000*

Steel-wire cup brushes, crimped steel



- For light surface processing and deburring work in all metal processing
- For processing larger areas, weld seams, metal plates
- Edging type: crimped steel wire

Diameter mm	Female thread	Wire thickness	Maximum speed /min	Sales unit / packing unit	Order no.
75	M 14	0.30 mm	11,000	1/1	623715000*
100	M 14	0.30 mm	8,600	1/1	623719000*

Steel-wire wheel brushes, twisted steel



- For universal use in metal processing, e.g. for processing of profiles, cutting edges, gear wheels, grooves, smoothing welding seams and points, stripping slag, scales and old paint
- Especially suitable for processing narrow workpieces as well as inner edges
- Edging type: twisted steel wire
- 623803000: offset version

Diameter mm	Female thread	Wire thickness	Maximum speed /min	Sales unit / packing unit	Order no.
100	M 14	0.50 mm	12,500	1/1	623803000*
115	M 14	0.50 mm	12,500	1/1	626770000*
125	M 14	0.50 mm	12,500	1/1	626771000*

Steel-wire wheel brush, twisted steel



- For universal use in metal processing, e.g. smoothing weld seams and points, stripping slag, scales and old paint
- Especially suitable for processing narrow workpieces as well as inner edges
- Most suitable for processing stainless steels
- Edging type: twisted stainless steel wire

Diameter mm	Female thread	Wire thickness	Maximum speed /min	Sales unit / packing unit	Order no.
115	M 14	0.50 mm	12,500	1/1	626778000*

Steel-wire wheel brushes, twisted steel, pipeline



- Specially developed for the professional processing of U and V-weld seams in pipeline construction, as well as for root weld seam preparation
- Edging type: twisted steel wire
- Thickness of plait: 6.0 mm

Diameter mm	Bore Ø	Wire thickness	Maximum speed /min	Sales unit / packing unit	Order no.
125	22.23	0.50 mm	12,500	1/1	626815000*
150	22.25	0.50 mm	10,000	1/1	626816000*

\* Self-service packaging

## Diamond cutting discs: Extremely easy cutting, precise and durable.

When processing concrete and natural stone you require high-quality, robust diamond discs. Metabo diamond cutting discs guarantee precise cutting as they are made from high-quality synthetic diamonds. The main disc body is made from hardened steel and thus guarantees highest safety criteria.

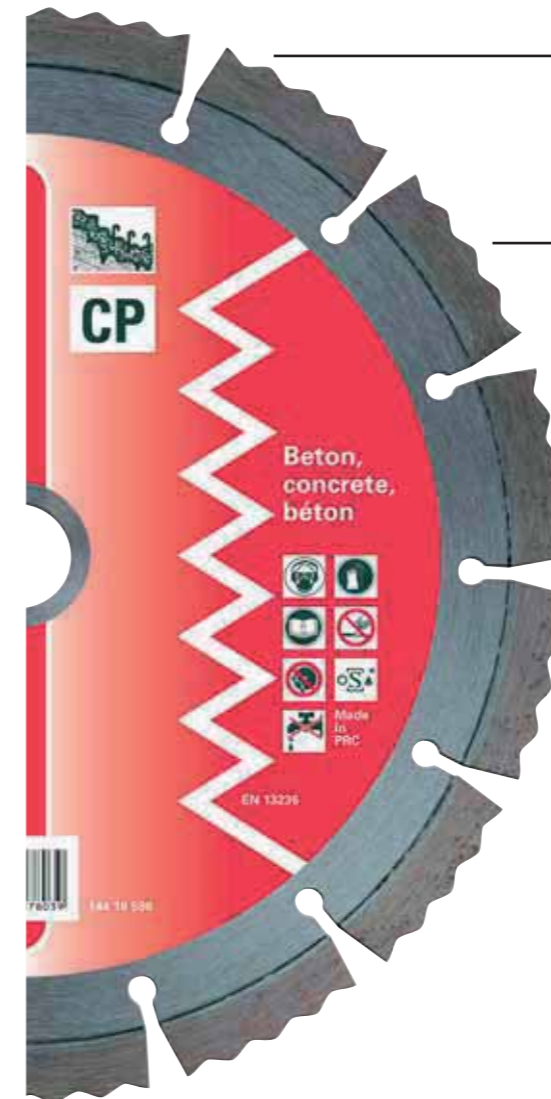

### Structure and function of Metabo diamond cutting discs

**The saw blade**  
For the stability and smooth running accuracy, the steel core of the Metabo diamond cutting discs is made of hardened steel of a very high quality. The notches between the segments are for cooling purposes and give the disc the required stability.

**The cutting segments**  
The diamond studded segments consist of a mixture of diamond grit and metal powder. In manufacturing of the Metabo diamond cutting discs, only synthetic diamonds of the best quality are used. The mixture of diamonds and bonding agent is compacted under high pressure and temperature. During this process the cutting segment obtains its form. It is thicker than the basic blade so that a relief clearance is obtained.

**Quality and area of application**  
The bond between the cutting segments and main disc body is a distinct aspect which you can use to measure for quality and/or the application in which the disc was designed for use:

**Soldering:**  
The connection between segment tips and the main disc is bonded with a silver solder. These discs are only utilized when cutting with water coolant. Due to the high temperatures generated when dry-cutting, segments can become detached. **Increased risk of accidents!**

**Sintering:**  
The cutting segments are bonded to the disc body with temperature and pressure. This bond is so strong that sintered cutting discs can be used for dry-cutting without a problem.

**Laser welding:**  
The best bond is presently obtained with the laser welding process. With the laser beam a strong micro bond between segment and the main disc body is obtained. **Laser welding gives safety of the highest level.**



**Mode of operation**  
Each Metabo diamond cutting disc is sharpened at the factory for immediate use. During the sharpening process, the residues between the individual diamonds on the cutting segment are removed.

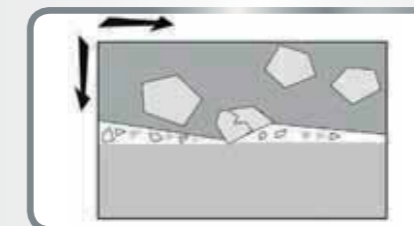

The metal bond holds all diamonds in place. During the cutting process the exposed diamonds slice through the contact material, leaving only a fine dust afterwards.

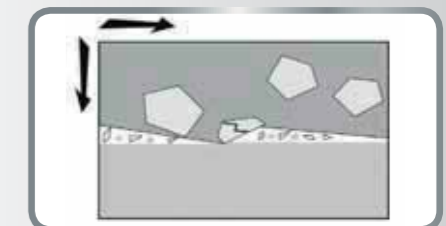



During the cutting process the diamonds splinter or break off. The harder the contact material the greater the wear. Simultaneously the material in the segment bond also wears off and bit by bit new diamonds are exposed.



Diameter x bore mm	Segment dimensions mm	Maximum speed /min	Sales unit	Order no.
 <p><b>Quality class »professional« / UP-T</b></p> <ul style="list-style-type: none"> <li>Best suited for general construction/building site materials such as concrete, exposed aggregate concrete, hard sandstone, clay tiles.</li> <li>The circumferentially closed »Turbo« cutting edge provides a clean cutting edge without material chipping, providing optimal cutting performance and long tool life.</li> <li>Sintered cutting edge</li> <li>Segment height: 9.6 mm; Maximum working speed 80 m/s</li> </ul>				
115 x 22.23	2.2 x 9.6	13,200	1	628124000*
125 x 22.23	2.2 x 9.6	12,200	1	628125000*
150 x 22.23	2.2 x 9.6	10,200	1	628126000*
180 x 22.23	2.5 x 9.6	8,500	1	628127000*
230 x 22.23	2.7 x 9.6	6,600	1	628128000*

Segmented; for hard materials

Diameter x bore mm	Segment dimensions mm	Number of segments	Maximum speed /min	Sales unit	Order no.
 <p><b>Quality class »classic« / CC</b></p> <ul style="list-style-type: none"> <li>Ideal for all hard materials such as concrete (including reinforced), concrete pipes, kerbstones, granite, hard sandstone, facing stones, exposed aggregate concrete.</li> <li>High diamond quality with soft bond for good cutting performance and optimal tool life</li> <li>Laser welded diamond segments, segment height: 7.0 mm; Maximum working speed 80 m/s (300 - 350 mm: 100 m/s)</li> </ul>					
115 x 22.23	32 x 2.15 x 7	8	13,200	1	628172000*
125 x 22.23	32 x 2.15 x 7	9	12,200	1	628173000*
150 x 22.23	38 x 2.15 x 7	10	10,200	1	628174000*
180 x 22.23	38 x 2.3 x 7	14	8,500	1	628175000*
230 x 22.23	40 x 2.5 x 7	15	6,600	1	628176000*
300 x 20	40 x 2.8 x 7	20	6,300	1	628177000*
350 x 20	40 x 3.2 x 7	24	5,400	1	628180000*

 <p><b>Quality class »professional« / CP</b></p> <ul style="list-style-type: none"> <li>Ideal for all hard building materials such as concrete (including reinforced), concrete pipes, granite, hard sandstones, facing stones, exposed aggregate concrete.</li> <li>The diamond quality and soft bond provides optimal cutting performance and long tool life</li> <li>Laser welded diamond segments</li> <li>Segment height: 12.0 mm; maximum working speed 80 m/s (300 - 350 mm: 100 m/s)</li> </ul>					
115 x 22.23	32 x 2.15 x 12	8	13,200	1	628129000*
125 x 22.23	32 x 2.15 x 12	9	12,200	1	628130000*
125 x 22.23	32 x 2.15 x 12	9	12,200	2	628131000*
150 x 22.23	38 x 2.15 x 12	10	10,200	1	628132000*
180 x 22.23	40 x 2.3 x 12	14	8,500	1	628133000*
230 x 22.23	40 x 2.5 x 12	15	6,600	1	628134000*
230 x 22.23	40 x 2.5 x 12	15	6,600	2	628135000*
300 x 20 / 22.23 / 25.4	40 x 3.2 x 12	20	6,300	1	628136000*
350 x 20 / 22.23 / 25.4	40 x 3.2 x 12	24	5,400	1	628139000*

Segmented for abrasive materials

Diameter x bore mm	Segment dimensions mm	Number of segments	Maximum speed /min	Sales unit	Order no.
 <p><b>Quality class »classic« / AC</b></p> <ul style="list-style-type: none"> <li>For all soft and abrasive materials such as fresh concrete, sand-lime brick, sand stone</li> <li>High diamond quality with hard bond for good cutting performance and optimal tool life</li> <li>Laser welded diamond segments, segment height: 7.0 mm; Maximum working speed 80 m/s (300 - 350 mm: 100 m/s)</li> </ul>					
115 x 22.23	32 x 2.15 x 7	8	13,200	1	628182000*
125 x 22.23	32 x 2.15 x 7	9	12,200	1	628183000*
150 x 22.23	38 x 2.15 x 7	10	10,200	1	628184000*
180 x 22.23	38 x 2.3 x 7	14	8,500	1	628185000*
230 x 22.23	40 x 2.5 x 7	15	6,600	1	628186000*
300 x 20	40 x 3.2 x 7	20	6,300	1	628187000*
350 x 20	40 x 3.2 x 7	24	5,400	1	628190000*

 <p><b>Quality class »professional« / AP</b></p> <ul style="list-style-type: none"> <li>For best cutting performance in soft, abrasive materials, such as fresh concrete, sand-lime brick, sand stone</li> <li>High diamond quality with soft bond ensures optimal cutting performance and long tool life</li> <li>Laser welded diamond segments</li> <li>Segment height: 12.0 mm; maximum working speed 80 m/s (300 - 350 mm: 100 m/s)</li> </ul>					
115 x 22.23	32 x 2.15 x 12	8	13,200	1	628141000*
125 x 22.23	32 x 2.15 x 12	9	12,200	1	628142000*
150 x 22.23	38 x 2.15 x 12	10	10,200	1	628143000*
180 x 22.23	40 x 2.3 x 12	14	8,500	1	628144000*
230 x 22.23	40 x 2.5 x 12	15	6,600	1	628145000*
300 x 20 / 22.23 / 25.4	40 x 3.2 x 12	20	6,300	1	628146000*
350 x 20 / 22.23 / 25.4	40 x 3.2 x 12	24	5,400	1	628149000*

For tiles; enclosed edge

Diameter x bore mm	Segment dimensions mm	Number of segments	Maximum speed /min	Sales unit	Order no.
 <p><b>Quality class »classic« / TC</b></p> <ul style="list-style-type: none"> <li>Special disc for all types of tiles, glazed and unglazed, natural stone slabs</li> <li>Good cutting performance and optimal tool life</li> <li>Diamond disc with a good price / performance ratio</li> <li>Sintered cutting edge, segment height: 7.0 mm; Maximum working speed 80 m/s</li> </ul>					
115 x 22.23	1.7 x 7		13,200	1	628192000*
125 x 22.23	1.7 x 7		12,200	1	628193000*
150 x 22.23	1.7 x 7		10,200	1	628194000*
180 x 22.23	1.7 x 7		8,500	1	628195000*
230 x 22.23	1.7 x 7		6,600	1	628196000*

 <p><b>Quality class »professional« / TP</b></p> <ul style="list-style-type: none"> <li>Special disc to meet the highest demands for all types of tiles, glazed and unglazed, natural stone slabs, fine earthenware</li> <li>Optimal cutting quality and long tool life.</li> <li>Sintered cutting edge</li> <li>Segment height: 10.0 mm; Maximum working speed 80 m/s</li> </ul>					
115 x 22.23	1.7 x 10		13,200	1	628151000*
125 x 22.23	1.7 x 10		12,200	1	628152000*
150 x 22.23	1.7 x 10		10,200	1	628153000*
180 x 22.23	1.7 x 10		8,500	1	628154000*
230 x 22.23	1.7 x 10		6,600	1	628155000*

\* Self-service packaging

### Diamond Cup Wheels

#### For hard materials, quality class concrete »professional«



- Powerful diamond grinding wheel. Particularly suited for grinding of thick concrete layers, levelling of concrete, preparation of concrete, removal of sludge residue and formwork seams on concrete, removal of hard cement, chalk-cement-plaster, hard screed, levelling of granite, natural stone and other very hard materials, for clean processing of edges, without chipping
- Maximum working speed 80 m/s

Diameter x bore mm	Number of segments	Sales unit	Order no.
125 x 22.23	16	1	628205000*

#### For abrasive materials, quality class abrasive »professional«



- Powerful diamond grinding cup wheel. Particularly suited for grinding of fresh concrete coatings, chalk and cement plaster, gypsum filler, levelling of fresh screed, removal of tile adhesive and processing of marble
- Maximum working speed 80 m/s

Diameter x bore mm	Number of segments	Sales unit	Order no.
125 x 22.23	16	1	628206000*

#### For protective concrete coatings, quality class »professional«



- Powerful specialized cup wheel. Ideally suited for spot grinding and removal of elastic protective coatings (on soft and hard surfaces), adhesives, sealants, removal of latex and oil paints, bitumen, PU/polyurethane, epoxy, elastic adhesive, for removal of lime plaster and gypsum plaster, abrading of resin plaster and hard cement plaster.
- Cup wheel equipped with PCD segments (poly-crystalline diamonds). By virtue of the PCD segments, particularly problematic coatings are removed quickly and effectively without bonding.
- Maximum working speed 80 m/s

Diameter x bore mm	Number of segments	Sales unit	Order no.
125 x 22.23	12	1	628208000*

#### For hard materials, quality class concrete »classic«



- Double-coated diamond cup wheel for grinding of thick concrete layers, levelling of concrete, preparation of concrete, removal of sludge skins and formwork seams on concrete, removal of hard cement, chalk-cement-plaster, hard screed, levelling of granite, natural stone and other very hard materials
- Maximum working speed 80 m/s

Diameter x bore mm	Number of segments	Sales unit	Order no.
125 x 22.23	20	1	628209000*

### Diamond Drill Bits

#### Diamond drill bits for tiles »Dry«, M14



- M14 Thread for use on angle grinders
- Vacuum hard soldered diamonds for a long service life and quick drilling progress
- Aperture in the shank for easy removal of the drilled core
- Developed for dry application, no extra cooling required. We recommend to briefly cool the tip with water in case of drilling in quick succession!
- We recommend using the thickness of the tile / fine earthenware / granite board as useful length. As a rule, max. 2 cm granite boards / work boards up to 5 cm can be drilled. Retract the drill bit often from the drilled hole so that it can cool down!
- Important: Do not drill into the subsurface in case of laid material!

Diameter mm	Overall length mm	Sales unit	Order no.
6	64	1	628300000*
8	64	1	628301000*
10	64	1	628302000*
12	64	1	628303000*
14	64	1	628304000*
18	91	1	628305000*
20	91	1	628306000*
25	91	1	628307000*
32	91	1	628308000*
35	91	1	628309000*
40	91	1	628310000*
45	91	1	628318000*
50	91	1	628311000*
55	91	1	628312000*
60	91	1	628313000*
68	91	1	628314000*
75	91	1	628315000*
82	91	1	628316000*

#### Diamond drill bit sets for tiles

- M14 Thread for use on angle grinders
- Vacuum hard soldered diamonds for a long service life and quick drilling progress
- Aperture in the shank for easy removal of the drilled core
- Developed for dry use, no separate cooling required

	Order no.
<p><b>Diamond drill bit set for tiles »Dry« 7 pieces</b> Set consisting of: each 1 x Ø 6 mm, 8 mm, 14 mm, 35 mm, 40 mm, 50 mm, 68 mm; 1 x Plusbox</p>	628317000
<p><b>Diamond drill bit set for tiles »Dry« , 3 pieces</b> Set consisting of: each 1 x Ø 35 mm, 50 mm, 68 mm; 1 x Plusbox L 623581000</p>	628322000

#### Adapter for diamond drill bits







	Order no.
<p><b>Connector</b> ■ For using »dry« diamond drill bits on a drill Receptacle: hexagonal 10 mm, M 14 male thread</p>	630859000*





\* Self-service packaging





## Which system accessories are suitable for which angle grinder?

Model	Order no.	 Bench cut-off stand Order no. 635000000	 Cutting-blade guard, semi-enclosed Order no. 630386000	 Guard Order no. 631166000	 Guard for cup wheel Ø 110 mm Order no. 623140000	 Metabo VibraTech (MVT) side handle Order no. 627360000	 »Quick« flange nut M 14 Order no. 630800000	 Flange nut M 14 Order no. 630706000
W 2000 (180)	606418		630386000	631166000				
W 22-180 MVT	606461		630356000	631166000				
WE 22-180 MVT	606463		630356000	631166000				
W 24-180 MVT	606466		630356000	631166000				
WE 24-180 MVT	606468		630356000	631166000				
WEA 24-180 MVT Quick	606471		630356000	631166000				
W 26-180 MVT	606473		630356000	631166000				
W 2000 (230)	606418		630387000	631167000				
WX 2000	606421		630387000	631167000				
W 2200-230	606420		630387000	631167000				
WX 2200-230	600397		630387000	631167000				
W 2400-230	600378		630387000	631167000				
WX 2400-230	600379		630387000	631167000				
W 22-230 MVT	606462		630357000	631167000				
WE 22-230 MVT	606464		630357000	631167000				
WE 22-230 MVT Quick	606465		630357000	631167000				
W 24-230 MVT	606467		630357000	631167000				
WE 24-230 MVT	606469		630357000	631167000				
WE 24-230 MVT Quick	606470		630357000	631167000				
WEA 24-230 MVT Quick	606472		630357000	631167000				
WEP 24-230 MVT	606477		630357000	631167000				
W 26-230 MVT	606474		630357000	631167000				
WE 26-230 MVT Quick	606475		630357000	631167000				
WEA 26-230 MVT Quick	606476		630357000	631167000				

Model	Order no.	 Clip for cut-off guard Order no. 630351000	 Cutting-blade guard, semi-enclosed Order no. 630356000	 Metabo VibraTech (MVT) side handle Order no. 627360000	 Quick-locking nut M 14 Order no. 630832000	 Flange nut M 14 Order no. 630706000
W 18 LTX 115	602170	630351000		627361000		
WP 18 LTX 115 Quick	613071	630351000		627361000		
WPB 18 LTX BL 115	613074	630351000		627361000		
W 18 LTX 125 Quick	602174	630352000		627361000		
WP 18 LTX 125 Quick	613072	630352000		627361000		
WB 18 LTX BL 125 Quick	613077	630352000		627361000		
WPB 18 LTX BL 125 Quick	613075	630352000		627361000		
W 18 LTX 125 Quick Inox	600174	630352000		627361000		
W 18 LTX 150	600404	630353000		627361000		
WB 18 LTX BL 150 Quick	613078	630353000		627361000		
WPB 18 LTX BL 150	613076	630353000		627361000		
WB 18 LTX BL 180	613087		630390000	627361000		
WPB 36 LTX BL 230	613101		630363000	627360000		
WPB 36-18 LTX BL 230	613102		630363000	627360000		

Model	Order no.	 Clip for cut-off guard Order no. 630351000	 Metabo VibraTech (MVT) side handle Order no. 627360000	 Bail handle Order no. 623262000	 Multi-position handle for side handle Order no. 627362000	 Dust protection filter (example illustration) Order no. 630709000	 Quick-locking nut M 14 Order no. 630832000	 Flange nut M 14 Order no. 630706000
WEF 9-125 Quick	613060	630355000						
WEPF 9-125 Quick	613069	630355000						
WEVF 10-125 Quick Inox	613080	630372000						
WEF 15-125 Quick	613082	630372000				630709000		
WEF 15-150 Quick	613083	630378000				630709000		
WEPBF 15-150 Quick	613084	630378000				630792000		
WEPF 15-150 Quick	613085	630378000				630792000		
WF 18 LTX 125	601306	630355000						
WPF 18 LTX 125	613070	630355000						

Other Accessories for Angle Grinders

Cutting guard clip



- For working with fibre-reinforced, resin-bonded cutting discs
- The cutting guard clip is simply attached to the existing guard of the angle grinder
- EN/EC 60745
- Material: plastic
- Suitable for Metabo angle grinder: W..8-..; W..9-..; W..10-..; W..11-..; W..12-..; W..14-..; W..15-..; W..17-..; W 18 LTX; from year of construction 2008

Grinding wheel Ø mm	Order no.
100	630346000
115	630351000
125	630352000
150	630353000

Abrasive cutting blade guards, semi-enclosed, with quick adjustment



- For working with fibre-reinforced, resin-bonded cutting discs
- EN/EC 60745

Grinding wheel Ø mm	Suitable for	Order no.
180	Metabo angle grinder Ø 180 mm (with clamping lever at the flange)	630370000
230	Metabo angle grinder Ø 230 mm (with clamping lever at the flange)	630371000
180	Metabo angle grinder Ø 180 mm (with clamping lever at the guard)	630356000
230	Metabo angle grinder Ø 230 mm (with clamping lever at the guard)	630357000
125	WEF 9-125 / WF 18 LTX 125	630355000
230	Metabo cordless angle grinder Ø 230 mm	630363000
125	WEF 15-125 Quick, WEVF 10-125 Quick	630372000
125	WQ 1000	630373000
150	WEF 15-150 Quick, WEPF 15-150 Quick, WEPBF 15-150 Quick	630378000
180	Metabo angle grinder WE...180...RT	630383000
180	W 17-180 / WX 17-180	630388000
180	WB 18 LTX 180 Quick	630390000

Cutting blade guards, semi enclosed, with holding bolt



- For working with fibre-reinforced, resin-bonded cutting discs
- EN/EC 60745

Grinding wheel Ø mm	Suitable for	Order no.
100	W 6-100	630813000
115	W 6-115	630814000
150	WE 1450-150 RT	630362000
125	W 1080-125	630364000
180	W 2000 / WX 2000	630386000
230	W 2000 / WX 2000	630387000

Bench cut-off stand



Bench Cut-off Stand

- Suitable for all Metabo angle grinders with cutting disc-Ø 230 mm, except for cordless angle grinder
  - For secure fixed use of the angle grinder as a cutting machine: also suitable for mitre cuts up to 45°
  - Largest cut depth when using an angle grinder with 230 mm cutting wheel = 50 mm; maximum span width = 100 mm
  - Dimensions of table top: 244 x 321 mm; table height: 34.5 mm
  - Scope of delivery: length stop, 6 mm Allen key
- Weight: 9.7 kg

Order no.

635000000

Cutting blade guards with cutting guides



Cutting extraction hood CED 125

- Extraction hood with plunge function and optimised flow channel for particularly low-dust cutting both indoors and outdoors
- Compact construction form table can be removed without tools for more flexibility when working close to walls and improved visibility for freehand cuts
- Tool-free adjustable cutting depth
- Robust sheet metal table for tilt-proof operation
- Anti-static plastic prevents electric charging and dust accumulations for a constantly high suction power
- Large, coloured operating elements for simple, tool-free adjustment, even when wearing gloves
- Connection for dust extraction Ø 35/41 mm
- Max. cutting depth for freehand cuts is 27 mm, with table 25 mm
- Suitable for: W..9-125; WEV 10-125 Quick; W..12-1..; WE..15-1..; WE..17-1..; W..8-1..; WE 9-125 Quick; W..11-1..; WQ 1400(only 6.00346); WE 14-1..; Not suitable for angle grinder with Autobalancer; scope of delivery incl. nut with two holes 5/8" and M14.

Grinding disc Ø: 115/125 mm  
Maximum cutting depth: 27 mm

Order no.

626730000



Cutting extraction hood CED 125 Plus

- Extraction hood with plunge function and optimised flow channel for particularly low-dust cutting both indoors and outdoors
- Compact construction form table can be removed without tools for more flexibility when working close to walls and improved visibility for freehand cuts
- Cutting depth can be adjusted without tools. Max. cutting depth for freehand cuts is 27 mm, with table 25 mm, with precision guide rail 20 mm
- Robust sheet metal table for tilt-proof operation. Connection for dust extraction Ø 35/41 mm
- Anti-static plastic prevents electric charging and dust accumulations for a constantly high suction power
- Large, coloured operating elements for simple, tool-free adjustment, even when wearing gloves
- Sheet metal table with guide rollers for easy, precise feed. Protect delicate surfaces from scratches.
- Enables the use of a Metabo precision guide rail for cuts with great precision
- Suitable for: W..9-125; WEV 10-125 Quick; W..12-1..; WE..15-1..; WE..17-1..; W..8-1..; WE 9-125 Quick; W..11-1..; WQ 1400(only 6.00346); WE 14-1..; Not suitable for angle grinder with Autobalancer; scope of delivery incl. nut with two holes 5/8" and M14.

Grinding disc Ø: 115/125 mm  
Maximum cutting depth: 27 mm

Order no.

626731000



Guard 180 mm

- With nozzles for vacuuming dust from cutting stone slabs
- For Metabo angle grinders 180 mm, except W 17-180 and WX 17-180; for angle grinders with tool-free guard adjustment, the clamping lever has to be removed  
Grinding disc Ø: 180 mm  
Maximum cutting depth: 42 mm

Order no.

631166000



Guard 230 mm







- With nozzles for vacuuming dust from cutting stone slabs
- For Metabo angle grinders 230 mm; for angle grinders with tool-free guard adjustment, the clamping lever has to be removed  
Grinding disc Ø: 230 mm  
Maximum cutting depth: 68 mm

Order no.

631167000



Cup wheel guards with accessories		Order no.
	<b>Grinding extraction hood GED 125</b> <ul style="list-style-type: none"> <li>Quick, tool-free installation of the extraction hood on a compatible angle grinder</li> <li>Integrated sliding segment for quick, tool-free access even when wearing gloves, for working close to walls.</li> <li>Extraction hood with flexible brush rim and optimised extraction channel for particularly low-dust grinding indoors and outdoors</li> <li>Anti-static plastic prevents electric charges and dust accumulations ensuring constantly high suction power. Connection for dust extraction Ø 35/41 mm</li> <li>Suitable for angle grinder with disc-Ø 125 mm: W..9-1.; WEV 10-125 Quick; W..12-1.; WE..15-1.; WE..17-1.; W..8-1.; WE 9-125 Quick; W..11-1.; WQ 1400 (only 600346); WE 14-1.; not suitable for WP 1200-125 RT, WEV 1500-125 RT, WE 1500-125 RT</li> </ul>	626732000
	<b>Replacement brush rim GED 125</b> <ul style="list-style-type: none"> <li>Replacement brush rim for replacement on the extraction hood GED 125</li> </ul>	626733000
	<b>Cup wheel guard Ø 80 mm</b> <ul style="list-style-type: none"> <li>For angle grinder with collar diameter 50 mm and grinding wheel-Ø 115 mm, 125 mm and 150 mm for the use of ceramic cup wheels Ø 80 mm</li> <li>For angle grinders with tool-free guard adjustment the clamping lever must be removed. Please pay attention to operating instructions!</li> <li>Adjustable</li> </ul>	623276000
	<b>Cup wheel guard Ø 110 mm</b> <ul style="list-style-type: none"> <li>For angle grinders with grinding wheel Ø of 180 and 230 mm for use of ceramic cup wheels Ø 110 mm</li> <li>Adjustable</li> </ul>	623140000
Support handles for angle grinders		Order no.
	<b>Metabo VibraTech (MVT) side handle, M 14</b> <ul style="list-style-type: none"> <li>Suitable for all angle grinders with M 14 thread</li> </ul>	627360000*
	<b>Metabo VibraTech (MVT) side handle, M 8</b> <ul style="list-style-type: none"> <li>Suitable for Metabo angle grinders with M 8 thread</li> </ul>	627361000*
	<b>Multi-positioning for side handle</b> <ul style="list-style-type: none"> <li>The 180° handle permits variable individual adjustment of the side handle position for ergonomic, low-fatigue working e.g. for cutting jobs or for left-handed users</li> <li>The side handle can be adjusted without tools for changing working positions</li> <li>The robust hexagon shape permits folding the side handle to the rear for safe, two-handed operation in confined spaces</li> <li>Suitable for W..9-1.; except: WEF 9-125 WEV 10-125; W..12-1.; WE15-1.; WE..17-1.; W..8-1.; WE9-125; W..11-1.; WEQ 1400-125; WE14-1.; WEVF 10-1.; WE..F 15-1.; WE..19-180..</li> <li>Not suitable for: WP 1200-125 RT, WEV 1500-125 RT, WE 1500-125 RT, WE 1500-150 RT</li> </ul>	627362000
		
	<b>Front handle WS</b> <ul style="list-style-type: none"> <li>Front handle with ideal ergonomics, e.g. for surface grinding with fibre discs, light polishing work with diamond cup wheels etc.</li> <li>Suitable for Metabo angle grinders W..9..; WE 10..; W..12..; WE 15..; WE 17..</li> <li>Not suitable for: WP 1200-125 RT, WEV 1500-125 RT, WE 1500-125 RT, WE 1500-150 RT</li> </ul>	623262000

\* Self-service packaging



Hand guard		Order no.
	<b>Hand Guard</b> <ul style="list-style-type: none"> <li>For fitting under the angle grinder's side support handle when working with the backing pads</li> <li>For all angle grinders</li> </ul>	630327000
Flange nuts and inner support flanges		Order no.
	<b>Flange nut</b> <ul style="list-style-type: none"> <li>For all angle grinders with M 14-spindle thread</li> </ul>	630706000
	<b>»Quick« flange nut M 14</b> <ul style="list-style-type: none"> <li>For all angle grinders, suitable also for other brands (required free spindle length min. 8 mm); required thread connection M 14; tool-free disc change</li> </ul>	630800000*
	<b>10 »Quick« flange nuts M 14</b> <ul style="list-style-type: none"> <li>For all angle grinders, suitable also for other brands (required free spindle length min. 8 mm); required thread connection M 14; tool-free disc change; 10 pieces in attractive counter display</li> </ul>	626411000
	<b>Metabo »Quick« flange nut M 14</b> <ul style="list-style-type: none"> <li>Especially for Metabo Quick system for tool-less disc change at the touch of a button. Suitable for all small Metabo angle grinders with M-Quick spindle button, except W 6-115, W 6-125, WB 11-125 required thread connection M 14</li> </ul>	630802000*
	<b>10 quick-locking nuts M 14</b> <ul style="list-style-type: none"> <li>Especially for angle grinders up to Ø 150 mm, for tool-free disc change. Required thread connection M 14. 10 pieces in attractive counter display</li> </ul>	630832000*
Inner support flange		Order no.
	<b>Inner support flange</b> <ul style="list-style-type: none"> <li>For all angle grinders with M14 spindle thread</li> </ul>	630705000

Dust protection filters

- Filter against coarse particles or chips for longer service life of the machine when working e.g. with ceramic fibre, roughing or cutting discs or polishing with lambswool
- Easy and fast cleaning thanks to exterior metal grid without disturbing connecting ribs
- Tool-free assembly and disassembly

	Order no.
 <p>Dust protection filter for all angle grinders W...12..., WE...15..., WE...17... standard (not paddle, not RT)</p>	630709000*
 <p>Dust protection filter for all angle grinders WE...17...RT, WE...19...RT</p>	630719000*
 <p>Dust protection filter for all angle grinders WP...12..., WEP...15..., WEP...17... with paddle switch</p>	630792000*

Flat-pin spanners

	Order no.
 <p><b>Flat-pin spanner</b> For angle grinders with disc diameter 100 mm - 150 mm Model: straight Grinding disc-Ø: 100/150 mm</p>	623934000*
 <p><b>Flat-pin spanner</b> For angle grinders with disc diameter 180 mm - 230 mm Model: straight Grinding disc-Ø: 180/230 mm</p>	623935000*
 <p><b>Flat-pin spanner</b> For angle grinders with disc Ø 115-230 mm Model: offset Grinding disc-Ø: 115/230 mm</p>	623910000*



Technical data

Wet Polisher PWE 11-100

For backing pad up to maximum	125 mm
Rated input power	1,100 W
Output power	620 W
No-load speed	1,700 - 6,100 /min
Revolutions at rated load	5,400 /min
Torque	2.6 Nm
Spindle threads	M 14
Weight (without mains cable)	2.2 kg
Cable length	4 m

Scope of delivery

Order no.	602050 <sup>1)</sup>
Bow-type handle	■
Front protective cap	■
PRCD safety switch	■
(without backing pad and buffing wheel)	■

<sup>1)</sup> also available in 120 V (North/Latin America)

Product advantages

- Polisher for wet processing of granite, marble and other high-quality types of rock
- Metabo Marathon-motor with patented dust protection for long service life
- Vario Tacho Constamatic (VTC) Full-wave Electronics with Thumbwheel: for working at customised speeds to suit the application material and speeds that remain almost constant, even under load
- Adjustable, external water supply for exact metering
- Housing cap for protection from splashes
- Adjustable front handle for safe and uniform guidance when polishing
- PRCD safety switch integrated in the mains cable
- Electronic overload protection for long service life
- Electronic soft start for smooth start-up
- Restart protection: prevents unintentional start-up after power supply interruption
- Auto-stop carbon brushes to protect the motor



NEW



Technical data	Angle Polisher PE 12-175	Angle polisher PE 15-25 set
For backing pad up to maximum	175 mm	180 mm
Rated input power	1,200 W	1,500 W
Output power	680 W	870 W
No-load speed	700 - 2,200 /min	700 - 2,500 /min
Revolutions at rated load	2,200 /min	2,250 /min
Torque	14 Nm	18 Nm
Spindle threads	M 14	M 14
Weight (without mains cable)	2.4 kg	2.4 kg
Cable length	4 m	4 m

Scope of delivery	602175	615250
Order no.	602175	615250
Hand guard	■	
Side handle	■	■
Safety goggles		■
3 Disc brushes (130 mm; P46, P60, P80)		■
Plastic carry case		■
(without buffing wheel)	■	

- Product advantages**
- Powerful polisher with two-level reduced gear for fine grinding and high-gloss polishing of stainless steel and stone surfaces
  - Rubberised front cap for optimal guidance of the polisher
  - Vario Tacho Constamatic (VTC) Full-wave Electronics with Thumbwheel: for working at customised speeds to suit the application material and speeds that remain almost constant, even under load
  - Overload protection: protects the motor from overheating
  - Electronic soft start for smooth start-up
  - Restart protection: prevents unintentional start-up after power supply interruption
  - Auto-stop carbon brushes to protect the motor
  - Renovation set with powerful polisher for restoration of beams of half-timbered houses and for restructuring wood
  - Maximum productivity thanks to powerful 1,500 Watt motor and high-performance planetary gear train
  - Tool-free adjustable bow-type handle for safe and uniform guidance when working

System components

Accessories → 171

Hook and loop backing pads



- With hook and loop, for attaching polishing and sanding accessories, maximum working speed: 80 m/s

Diameter mm	Thickness mm	Female thread	Max. speed rpm	Sales unit	Order no.
113	2	M 14	13,000	1	624840000*
123	12	M 14	12,000	1	623287000*
147	12	M 14	10,000	1	623288000*
173	12	M 14	8,500	1	623289000*
113	12	5/8 "	13,000	1	623272000*
173	12	5/8 "	8,500	1	623273000*

Hook and loop polishing sponges, coarse



- For polishing up weathered paintwork

Diameter mm	Thickness mm	Sales unit	Order no.
80	25	1	624912000*
130	25	1	624913000*
160	25	1	624915000*
160	50	1	624916000*

Pressure polishing sponges, fine



- For polishing paintwork

Diameter mm	Thickness mm	Sales unit	Order no.
80	20	1	624092000*
130	25	1	624967000*
130	50	1	624926000*
160	25	1	624968000*
160	50	1	624927000*

Hook and loop polishing felt, soft



- For polishing paintwork, non-ferrous metals, and steel sheets

Diameter mm	Thickness mm	Sales unit	Order no.
130	5	1	624964000*
155	5	1	624965000*

Hook and loop lambswool polishing discs



- For high-gloss polishing

Diameter mm	Sales unit	Order no.
85	1	624063000*
130	1	631223000*
150	1	631217000*

Lambswool bonnets with tightening cord



- For high-gloss polishing

Diameter mm	Sales unit	Order no.
180	1	623265000*



Plastic disc brushes



- SiC grinding filaments, undulated, Ø 1.27 mm. For processing, deburring, grinding and structuring of surfaces. Suitable for steel, cast steel, NF-metals, wood, and plastics. Maximum working speed: 19 m/s, recommended speed: 1,200-1,900 min<sup>-1</sup>

Diameter mm	Grit	Sales unit	Order no.
130	P 46	1	623740000
130	P 60	1	623741000
130	P 80	1	623742000

Additional accessories for polishers

		Order no.
	<b>Extension piece M 14/ M 14</b> ■ For working with the backing pads; increases the distance between the machine spindle and the backing pad by approximately 35 mm; with M 14 female thread and M 14 male thread	631360000*
	<b>Arbor</b> ■ For 2 buffing mops with flanges and adjusting nut	623107000*
	<b>Vienna lime chalk</b> ■ For cleaning, caring and polishing of smooth surfaces, especially stainless steel, silver, brass, glass, ceramic etc. ■ Contents: 300 g, shaker	626399000



# Processing Stainless Steel

\* Self-service packaging



If you want a perfect finish, you need perfect machines.

MITRED WELDED PIPES

1. SATIN-FINISH

WEV 15-125 Quick Inox	WEV 15-125 Quick Inox	KNSE 9-150	RBE 15-180
 Order no. 600572	 Order no. 600572	 Order no. 602265	 Order no. 602243

2. POLISHING

RBE 15-180	RBE 15-180	RBE 15-180	RBE 15-180	KNSE 9-150	RBE 15-180
 Order no. 602243	 Order no. 602243	 Order no. 602243	 Order no. 602243	 Order no. 602265	 Order no. 602243

WELDED SEAMS ON SURFACES

1. SATIN-FINISH

SE 17-200 RT	SE 17-200 RT	SE 17-200 RT	SE 17-200 RT
 Order no. 602259	 Order no. 602259	 Order no. 602259	 Order no. 602259

2. POLISHING

SE 17-200 RT	SE 17-200 RT	SE 17-200 RT	SE 17-200 RT
 Order no. 602259	 Order no. 602259	 Order no. 602259	 Order no. 602259



Technical data

Flat-head Angle Grinder WEVF 10-125 Quick Inox Set

Minimum accessible angle	43 °
Grinding wheel Ø	125 mm
Rated input power	1,000 W
Output power	590 W
No-load speed	2,000 - 7,600 /min
Revolutions at rated load	6,300 /min
Torque	3.5 Nm
Spindle threads	M 14
Weight (without mains cable)	2.3 kg
Cable length	4 m

Scope of delivery

Order no.	613080500 <sup>1)</sup>	613080000 <sup>1)</sup>
Guard	■	■
Inner support flange	■	■
Quick-locking nut	■	■
Side handle	■	■
5 Flap discs Flexiamant Super Convex (125 mm; P60)	■	
2 Combination flap discs (125 mm; medium)	■	
2 Fleece compact grinding disc »Unitized« (125 mm, coarse)	■	
2 Fleece compact grinding disc »Unitized« (125 mm, medium)	■	
1 Profiling file incl. 2 sanding paper strips	■	
Metal carry case	■	

<sup>1)</sup> also available in 120 V (North/Latin America)

Product advantages

- The most easy-to-handle flat-head angle grinder with speed regulation for perfect processing of stainless steel e.g. railings and hand rails
- Particularly developed for the removal of weld slag, rust or paint in narrow frame constructions and for working in tight spaces
- Longer service life, more power: the Metabo Marathon-motor with patented dust protection, up to 20% more overload capacity and 50% more torque
- Thumbwheel controlled Vario-Constamatic (VC)-Full wave electronics ideal for working on materials requiring customised speeds, and at speeds which remain almost constant under load
- Metabo Quick for tool-free disc change by means of a quick-locking nut
- Electronic safety shutdown: reduces kickback if the disc stops unexpectedly - for high user safety
- Electronic overload protection, soft start and restart protection
- Gear housing can be unscrewed, rotated in 90° steps and remounted for left-handed operation or cutting

System components

Accessories ▶ 177



Technical data

Angle Grinder WEV 15-125 Quick Inox Set

Grinding wheel Ø	125 mm
Rated input power	1,550 W
Output power	940 W
No-load speed	2,000 - 7,600 /min
Revolutions at rated load	7,600 /min
Torque	5 Nm
Spindle threads	M 14
Weight (without mains cable)	2.5 kg
Cable length	4 m

Scope of delivery

Order no.	600572500 <sup>1)</sup>	600572000 <sup>1)</sup>
Guard	■	■
Inner support flange	■	■
M-Quick flange nut	■	■
Metabo VibraTech (MVT) side handle	■	■
2 Combi flap discs (medium)	■	
Fleece compact grinding disc »Unitized«	■	
Hook and loop backing pad pyramid (Ø 125 mm)	■	
Hook and loop backing pad (soft, Ø 125 mm)	■	
15 Hook and loop sanding sheets Metabo Pyramid (5 each of A30/A45/A65)	■	
Hook and loop abrasive nylon web P280	■	
Metal carry case	■	

<sup>1)</sup> also available in 120 V (North/Latin America)

Product advantages

- Perfect processing of stainless steel: robust, powerful angle grinder with high gear reduction and adjustable reduced speed for cool finish
- Longer service life, more power: the Metabo Marathon-motor with patented dust protection, up to 20% more overload capacity and 50% more torque
- Vario Tacho Constamatic (VTC) Full-wave Electronics with Thumbwheel: for working at customised speeds to suit the application material and speeds that remain almost constant, even under load
- Tool free, fast disc change at the touch of a button with the Metabo M-Quick-System
- Low-vibration side handle Metabo VibraTech (MVT)
- Metabo S-automatic mechanical safety clutch: minimises kick-back to the lowest level when the disc jams unexpectedly - for maximum user safety and swift progress
- Electronic overload protection, soft start and restart protection
- Gear housing can be unscrewed, rotated in 90° steps and remounted for left-handed operation or cutting





18 V



Technical data	Angle Grinder WEV 17-125 Quick Inox RT
Grinding wheel Ø	125 mm
Rated input power	1,750 W
Output power	1,070 W
No-load speed	2,000 - 7,600 /min
Revolutions at rated load	7,600 /min
Torque	5 Nm
Spindle threads	M 14
Weight (without mains cable)	2.5 kg
Cable length	4 m

Scope of delivery	Order no.
Order no.	601092
Guard	■
Inner support flange	■
M-Quick flange nut	■
Metabo VibraTech (MVT) side handle	■

Product advantages

- The specialist with high torque and speed control for processing stainless steel and for working with aggressive fibre discs
- Perfect ergonomics thanks to slim handle for maximum control and easy working overhead
- Metabo Marathon-motor with new cooling and carbon brush system for twice the service life
- Vario Tacho Constamatic (VTC) Full-wave Electronics with Thumbwheel: for working at customised speeds to suit the application material and speeds that remain almost constant, even under load
- M-Quick System for tool-free disc change at the touch of a button
- Tool-free adjustable guard; twist-proof
- Low-vibration side handle Metabo VibraTech (MVT)
- Metabo S-automatic mechanical safety clutch: minimises kick-back to the lowest level when the disc jams unexpectedly - for maximum user safety and swift progress
- Electronic soft start and restart protection
- Gear housing can be unscrewed, rotated in 90° steps and remounted for left-handed operation or cutting
- Auto-stop carbon brushes to protect the motor

System components

Accessories → 177

Battery packs → 72

Technical data	Cordless Angle Grinder W 18 LTX 125 Quick Inox
Type of battery pack	Li-Ion / LiHD
Battery pack voltage	18 V
Grinding wheel Ø	125 mm
No-load speed	5,000 /min
Spindle threads	M 14
Weight (including battery pack)	2.4 kg

Scope of delivery	Order no.
Order no.	600174
Guard	■
Inner support flange	■
Quick-locking nut	■
Side handle	■
Dust filter	■
without battery pack, without charger	■

Product advantages

- Speed and torque configured precisely for stainless steel processing ensuring a cool grinding action with perfect finish
- Slim design for prolonged comfort when working overhead or in areas with limited space
- Metabo Quick for tool-free disc change by means of a quick-locking nut
- Tool-free adjustable guard; twist-proof
- Battery pack can be swivelled for better access in hard to reach places
- Overload protection: protects the motor from overheating
- Electronic soft start for smooth start-up
- Restart protection: prevents unintentional start-up after power supply interruption
- Detachable dust protection filter protects motor from coarse particles

Fleece compact polishing discs »Unitized« - VKS



- Made of compacted fleece material on a fibreglass backing pad
- For cleaning and polishing surfaces, for smoothing weld seams; reduces the number of working stages required
- For alloy and high-alloy steels, coloured and light metals, chrome and nickel steels, titanium, steels
- Max. torque: 8,000 /min; 52 m/s
- Recommended speed: 3,000 /min

Diameter x thickness x bore mm	Grit	Sales unit / packing unit	Order no.
125 x 22.23	Very fine	1/1	626368000*
125 x 22.23	Very fine	5/1	626417000

Fleece compact grinding discs »Unitized« - VKS-ZK



- Several layers of pressed fleece material, soaked with resin-bonded abrasive grain (zirconia alumina)
- The addition of abrasive grain covers a range of applications from deburring to soft and flexible finishing jobs. It is suited for deburring, smoothing of weld seams, precise cleaning and finishing of surfaces.
- For alloy and high-alloy steels, coloured and light metals, chrome and nickel steels, titanium, steels
- Profiling of the grinding media possible for precise working. Very low roughing of the processed material.
- Bore 22.23 mm (for angle grinder)
- Max. 10,000 rpm; recommended speed: 3,000 rpm

Diameter x thickness x bore mm	Grit	Sales unit / packing unit	Order no.
125 x 6 x 22.23	Coarse	1/5	626482000
125 x 6 x 22.23	medium	1/5	626483000

Combination flap discs - KLS



- Made from high-quality pink aluminium oxide fabric in combination with high-quality nylon web.
- For removal of material to fine polish in a single process. Very even grinding/polishing result with good material removal.
- For processing weld seams for example, and for grinding or polishing. For removing minor scratches and damage to the work piece.
- Suitable for grinding, cleaning and finishing work on stainless steel, steel, coloured and light metals, titanium alloys.
- Maximum working speed: 80 m/s
- Recommended speed: 3,000 /min

Diameter x bore mm	Grit	Sales unit / packing unit	Order no.
125 x 22.23	Coarse	1/1	626369000*
125 x 22.23	Coarse	5/1	626415000
125 x 22.23	medium	1/1	626370000*
125 x 22.23	medium	5/1	626416000

Flap discs



- Quality class zirconia alumina »Flexiamant Convex«**
- Specially shaped flap disc with lamellae that are rounded off towards the outer edges.
  - Grinding media: Zirconia alumina
  - Thanks to the special design it is particularly suited for processing fillet welds; making faster and more efficient processing possible; also suitable for surface grinding
  - High material removal with very high tool life thanks to the use of zirconia alumina
  - Suitable for processing stainless steel and steel
  - Uniform grinding result, comfortable grinding with only low vibration
  - Maximum working speed 80 m/s

Diameter x bore mm	Grit	Version	Maximum speed /min	Sales unit / packing unit	Order no.
125 x 22.23	P 40	—	12,200	1/10	626462000
125 x 22.23	P 60	—	12,200	1/10	626463000
125 x 22.23	P 80	—	12,200	1/10	626464000

\* Self-service packaging



**Quality class ceramic »Flexiamant Super Convex«**

- Specially shaped flap disc with lamellae that are rounded off towards the outer edges.
- Thanks to the special design it is particularly suited for processing fillet welds; making faster and more efficient processing possible; also suitable for surface grinding
- Very high material removal with very high tool life thanks to the use of ceramic grain.
- Cool cut for materials with poor thermal conduction
- For grinding of steel and stainless steel. Ideal for extreme grinding jobs like processing high-alloy steels, titanium alloys, nickel-based alloys as well as chromium and chromium-nickel steels, brass and bronze thanks to high load capacity.
- Uniform grinding result, comfortable grinding with only low vibration
- Maximum working speed 80 m/s

Diameter x bore mm	Grit	Version	Maximum speed /min	Sales unit / packing unit	Order no.
125 x 22.23	P 60		12,200	1/10	626460000
125 x 22.23	P 80		12,200	1/10	626461000

**Flap wheels**



**Quality class ceramic »Flexiamant Super«**

- Flap wheel with straight profiled lamellae, particularly suited for processing fillet welds. The profiled lamellae, arranged radially in the shape of a fan, adapt exceptionally well to the contours of the work piece. Ideally suited for an even and smooth weld seam. Thanks to the offset shape it can also be used at hard to reach places.
- High material removal with high tool life thanks to the use of ceramic grain.
- Excellent results for surface and edge grinding of steel and stainless steel. Ideal for extreme grinding jobs like processing high-alloy steels, titanium alloys, nickel-based alloys as well as chromium and chromium-nickel steels, brass and bronze thanks to high load capacity.
- Cool cut for materials with poor thermal conduction
- Maximum speed: 10,000 rpm

Diameter mm	Thickness mm	Female thread	Grit	Version	Maximum speed /min	Sales unit / packing unit	Order no.
125	8	M 14	P 40		10,000	1/5	626470000
125	8	M 14	P 60		10,000	1/5	626471000
125	8	5/8 "	P 40		10,000	1/5	626486000
125	8	5/8 "	P 60		10,000	1/5	626487000

**»Metabo Pyramid« hook and loop sanding sheets**



- 3-dimensional structure of the grinding media (pyramid-shaped).
- High material removal with, at the same time, a very even and fine grinding result. Long service life. Faster progress when compared to tradition grinding media thanks to the considerable reduction in the number of working stages.
- For removing scratches, rolling marks on stainless steel. Prepare for polishing.
- Suitable for use throughout the metal industry; especially for stainless steels, titanium, cobalt, nickel, chrome alloys.

Diameter mm	Grit	Sales unit	Order no.
125	P 120 (A 160)	5	626371000*
125	P 280 (A 65)	5	626372000*
125	P 400 (A 45)	5	626373000*
125	P 600 (A 30)	5	626374000*
125	P 1200 (A 16)	5	626403000*
125	P 2000 (A 6)	5	626404000*

**Hook and loop backing pads »Metabo Pyramid«**



- Hook and loop, with flexible intermediate layer, foam-moulded; for attaching polishing and sanding accessories
- Sanding pad for polishing and medium-hard grinding jobs. Especially recommended for Metabo Pyramid hook and loop sanding sheets.

Female thread	Diameter mm	Thickness mm	Sales unit	Order no.
5/8 "	125	3	1	623298000*
M 14	125	3	1	623300000*

**Hook and loop fleece compact discs »Unitized« - VKS**



- Made from pressed fleece material with hook and loop
- For cleaning and polishing surfaces, for smoothing weld seams; reduces the number of working stages required
- For alloy and high-alloy steels, coloured and light metals, chrome and nickel steels, titanium, steels

Diameter mm	Grit	Sales unit	Order no.
125	Very fine	1	626375000*

**Cleaning fleeces**



- For the removal of light rust, paint / varnish on metal, cleaning weld seams / steel / copper / aluminium / brass, sanding steel and texturing wood.
- Maximum working speed: 63 m/s
- Recommended speeds at Ø 115 mm: 2,900 /min, Ø 125 mm: 2,700 /min

Diameter x bore mm	Sales unit	Order no.
115 x 22.23	1	624346000*
125 x 22.23	1	624347000*

**Further accessories for Inox angle grinders**

	Order no.
<p><b>Vienna lime chalk</b></p> <ul style="list-style-type: none"> <li>■ For cleaning, caring and polishing of smooth surfaces, especially stainless steel, silver, brass, glass, ceramic etc.</li> <li>■ Contents: 300 g, shaker</li> </ul>	626399000
<p><b>Stainless steel adhesive tape</b></p> <ul style="list-style-type: none"> <li>■ For mitre cuts of welded stainless steel profiles.</li> <li>■ Dimensions: 2.5 m x 40 x 0.15 mm</li> </ul>	626376000
<p><b>3 Micro-fibre cloths 380 x 380 mm</b></p> <ul style="list-style-type: none"> <li>■ For cleaning and evenly distributing protective media and polishes, for removing pastes and cream residue</li> <li>■ Suitable for all metals and hard plastics</li> </ul>	626398000*
<p><b>Stainless steel cleaning spray 400 ml</b></p> <ul style="list-style-type: none"> <li>■ For cleaning, conserving and sealing of surfaces, especially of stainless steels.</li> </ul>	626377000

\* Self-service packaging



18 V



Technical data	Band File BFE 9-20 Set
Rated input power	950 W
Output power	510 W
Belt speed in idle	9 - 20 m/s
Grinding belt width	6 - 19 mm
Grinding belt length	457 mm
Useable length of sanding belt arm	90 mm
Weight (without mains cable)	1.8 kg
Cable length	4 m

Scope of delivery	602244500 <sup>1)</sup>	602244000
Order no.		
Side handle	■	■
Sanding belt arm 1 (for belt width 6 and 13 mm)	■	■
Sanding belt arm 4 (for belt width 19 mm)	■	
10 Sanding belts zirconia (6x457 mm; P60)	■	
10 Sanding belts zirconia (6x457 mm; P120)	■	
10 Sanding belts zirconia (19x457 mm; P60)	■	
10 Sanding belts zirconia (19x457 mm; P120)	■	
2 Fleece bands (6x457 mm; medium)	■	
2 Fleece bands (19x457 mm; medium)	■	
Metal carry case	■	

<sup>1)</sup> also available in 120 V (North/Latin America)

**Product advantages**

- Powerful, compact band file for grinding, satin-finish and deburring in difficult to reach places
- Metabo Marathon-motor with patented dust protection for long service life
- Thumbwheel controlled Vario-Constamatic (VC)-Full wave electronics ideal for working on materials requiring customised speeds, and at speeds which remain almost constant under load
- Grinding attachment can be swivelled by 270° without tools for perfect adaptation to any working position
- Profiled drive roller: reduces slipping of the sanding belt
- Tool-free sanding belt change and adjustable belt guide
- Electronic soft start for smooth start-up
- Auto-stop carbon brushes to protect the motor

**System components**

Accessories → 181

Battery packs → 72

Technical data	Cordless Band File BF 18 LTX 90
Type of battery pack	Li-Ion / LiHD
Battery pack voltage	18 V
Belt speed in idle	8 m/s
Grinding belt width	6 - 19 mm
Grinding belt length	457 mm
Useful length of sanding belt arm	90 mm
Weight (including battery pack)	2.6 kg

Scope of delivery	600321
Order no.	
Side handle	■
Dust filter	■
Sanding belt arm 1 (for belt width 6 and 13 mm)	■
Hexagonal wrench	■
without battery pack, without charger	■

**Product advantages**

- Powerful, compact cordless band file for grinding, satin-finish and deburring in places difficult to reach
- Robust motor for long service life
- Tool-free sanding belt change and adjustable belt guide
- Grinding attachment can be swivelled by 270° without tools for perfect adaptation to any working position
- Battery pack can be swivelled for better access in hard to reach places
- Detachable dust protection filter protects motor from coarse particles
- Overload protection: protects the motor from overheating
- Electronic soft start for smooth start-up
- Restart protection: prevents unintentional start-up after power supply interruption

**Zirconia alumina sanding belts**



- For all metal uses, particularly suited to the processing of rust-free steel/stainless steel. Grinding material with cotton base.
- High material removal with good service life. Even grinding result.
- For rough-polishing and deburring of steel and stainless steel
- Recommended circumferential speed: 15-25 m/s

Dimensions mm	Grit	Sales unit	Order no.
6 x 457	P 40	10	626344000*
6 x 457	P 60	10	626345000*
6 x 457	P 80	10	626346000*
6 x 457	P 120	10	626347000*
13 x 457	P 40	10	626348000*
13 x 457	P 60	10	626349000*
13 x 457	P 80	10	626350000*
13 x 457	P 120	10	626351000*
19 x 457	P 40	10	626352000*
19 x 457	P 60	10	626353000*
19 x 457	P 80	10	626354000*
19 x 457	P 120	10	626355000*

**Ceramic grain sanding belts**



- For all metal uses, particularly suited to the processing of rust-free steel/stainless steel. Grinding material with cotton base.
- Extremely high material removal with extremely high tool life thanks to the self-sharpening ceramic grain. Even grinding and best results.
- For pre-polishing and fine polishing, for example, of contours, profiles, etc.
- Recommended circumferential speed: 15-25 m/s for stainless steel
- Recommended circumferential speed: 20-30 m/s for NF metals
- Recommended circumferential speed: 5-10 m/s for high temperature Ni-/ Co- alloys

Dimensions mm	Grit	Sales unit	Order no.
13 x 457	P 40	10	626360000*
13 x 457	P 60	10	626361000*
13 x 457	P 80	10	626362000*
13 x 457	P 120	10	626363000*





**Fleece bands**







- For grinding, cleaning and finishing work. For removing scratches, colour runs and oxide layers.
- For preparing, pre-grinding and polishing weld seams
- Recommended circumferential speed: 25-30 m/s for steel
- Recommended circumferential speed: 15-25 m/s for stainless steel
- Recommended circumferential speed: 30-40 m/s for soft NF metals
- Recommended circumferential speed: 5-15 m/s for high temperature Ni-/ Co alloys

Dimensions mm	Grit	Sales unit	Order no.
6 x 457	Coarse	5	626383000*
6 x 457	medium	5	626384000*
6 x 457	Very fine	5	626386000*
13 x 457	Coarse	5	626387000*
13 x 457	medium	5	626388000*
13 x 457	Very fine	5	626390000*
19 x 457	Coarse	5	626391000*
19 x 457	medium	5	626392000*
19 x 457	Very fine	5	626394000*

\* Self-service packaging

Sanding belt arms		Order no.
	<b>Sanding belt arm 1</b> <ul style="list-style-type: none"> <li>Standard equipment of the machine. Suitable for sanding belts 6 x 457 mm and 13 x 457 mm.</li> <li>For sanding narrow areas, weld seams, deburring edges, sanding grooved sections on tongued and groove boards.</li> </ul>	626379000*
	<b>Sanding belt arm 2</b> <ul style="list-style-type: none"> <li>Suitable for sanding belts 6 x 457 mm.</li> <li>For sanding narrow areas, edges, deburring pipes, sanding grooved sections on tongued and groove boards.</li> </ul>	626380000*
	<b>Sanding belt arm 3</b> <ul style="list-style-type: none"> <li>Suitable for sanding belts 13 x 457 mm</li> <li>For sanding edges, deburring pipes, sanding blunt welds.</li> </ul>	626381000*
	<b>Sanding belt arm 4</b> <ul style="list-style-type: none"> <li>Suitable for sanding belts 19 x 457 mm.</li> <li>For grinding of edges and surfaces and for grinding out of radii and transitions</li> </ul>	626382000*

Additional accessories for band files		Order no.
	<b>Adapter band file</b> <ul style="list-style-type: none"> <li>For extension of the sanding belt arms. For the use of sanding belts with a belt length of 520 mm and 533 mm.</li> </ul>	626378000
	<b>Vienna lime chalk</b> <ul style="list-style-type: none"> <li>For cleaning, caring and polishing of smooth surfaces, especially stainless steel, silver, brass, glass, ceramic etc.</li> <li>Contents: 300 g, shaker</li> </ul>	626399000
	<b>3 Micro-fibre cloths 380 x 380 mm</b> <ul style="list-style-type: none"> <li>For cleaning and evenly distributing protective media and polishes, for removing pastes and cream residue</li> <li>Suitable for all metals and hard plastics</li> </ul>	626398000*
	<b>Stainless steel cleaning spray 400 ml</b> <ul style="list-style-type: none"> <li>For cleaning, conserving and sealing of surfaces, especially of stainless steels.</li> </ul>	626377000



Technical data	Fillet Weld Grinder KNSE 9-150 Set
Rated input power	950 W
Output power	510 W
No-load speed	900 - 3,800 /min
Disc diameter	150 mm
Spindle threads	M 14
Weight (without mains cable)	2.7 kg
Cable length	4 m

Scope of delivery	
Order no.	602265 <sup>1)</sup>
Guard	■
Inner support flange	■
Nut with two holes	■
Side handle	■
Flat-pin spanners	■
Hexagonal wrench	■
1 Fleece compact disc (150x6x25.4 mm; medium)	■
1 Fleece compact disc (150x6x 25.4 mm; very fine)	■
2 Fleece compact discs (150x3x 25.4 mm; medium)	■
1 Polishing file (incl. 2 sanding paper strips)	■
Metal carry case	■

<sup>1)</sup> also available in 120 V (North/Latin America)

- Product advantages**
- Very flat fillet weld grinder for processing stainless steel fillet welds in tight spaces
  - Powerful, and with double reduction gearing for effective working
  - Metabo Marathon-motor with patented dust protection for long service life
  - Thumbwheel controlled Vario-Constamatic (VC)-Full wave electronics ideal for working on materials requiring customised speeds, and at speeds which remain almost constant under load
  - Robust planetary gear train for particularly long service life
  - Adjustable without tools, removable guard
  - Low-maintenance belt drive for long service life
  - Overload protection: protects the motor from overheating
  - Electronic soft start for smooth start-up
  - Restart protection: prevents unintentional start-up after power supply interruption
  - Auto-stop carbon brushes to protect the motor

**System components**

Accessories → 184

Battery packs → 72

18 V



Technical data	Cordless Fillet Weld Grinder KNS 18 LTX 150
Type of battery pack	Li-Ion / LiHD
Battery pack voltage	18 V
No-load speed	3,800 /min
Disc diameter	150 mm
Spindle threads	M 14
Weight (including battery pack)	3 kg

Scope of delivery	
Order no.	600191
Guard	■
Inner support flange	■
Nut with two holes	■
Side handle	■
Dust filter	■
Flat-pin spanners	■
Hexagonal wrench	■
without battery pack, without charger	■

- Product advantages**
- Very flat cordless fillet weld grinder for processing stainless steel weld seams in tight spaces
  - Robust motor for long service life
  - Adjustable without tools, removable guard
  - Low-maintenance belt drive for long service life
  - Battery pack can be swivelled for better access in hard to reach places
  - Detachable dust protection filter protects motor from coarse particles
  - Overload protection: protects the motor from overheating
  - Electronic soft start for smooth start-up
  - Restart protection: prevents unintentional start-up after power supply interruption

\* Self-service packaging

Fleece compact grinding discs »Unitized« - VKS



- Made from pressed fleece material
- For cleaning and polishing surfaces, for smoothing weld seams; reduces the number of working stages required
- For alloy and high-alloy steels, coloured and light metals, chrome and nickel steels, titanium, steels
- The fleece compact disc can be shaped with the profiling file (626396000)
- Maximum working speed: 60 m/s
- Maximum speed: 6,000 /min
- Recommended speed: 3,000 /min

Diameter x thickness x bore mm	Grit	Sales unit	Order no.
150 x 3 x 25.4	medium	1	626400000*
150 x 6 x 25.4	Very fine	1	626401000*
150 x 6 x 25.4	medium	1	626402000*



Felt Disc



- For polishing stainless steel and non-ferrous metals, always in conjunction with a polishing paste.
- Maximum working speed: 31 m/s
- Maximum speed: 3,900 /min
- Recommended speed: 600-1,100 /min

Diameter x thickness x bore mm	Grit	Sales unit	Order no.
150 x 5 x 25.4	Soft	1	626395000*

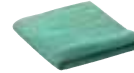
Additional accessories for fillet weld grinders

	Order no.
 <p><b>Vienna lime chalk</b></p> <ul style="list-style-type: none"> <li>■ For cleaning, caring and polishing of smooth surfaces, especially stainless steel, silver, brass, glass, ceramic etc.</li> <li>■ Contents: 300 g, shaker</li> </ul>	626399000
 <p><b>3 Micro-fibre cloths 380 x 380 mm</b></p> <ul style="list-style-type: none"> <li>■ For cleaning and evenly distributing protective media and polishes, for removing pastes and cream residue</li> <li>■ Suitable for all metals and hard plastics</li> </ul>	626398000*
 <p><b>Stainless steel cleaning spray 400 ml</b></p> <ul style="list-style-type: none"> <li>■ For cleaning, conserving and sealing of surfaces, especially of stainless steels.</li> </ul>	626377000



Technical data	Burnishing Machine SE 17-200 RT Set
Rated input power	1,700 W
Output power	1,070 W
No-load speed	800 - 3,000 /min
Torque	17 Nm
Spindle threads	M14
Abrasive tool diameter	100 - 200 mm
Abrasive tool width	50 - 100 mm
Weight (without mains cable)	2.9 kg
Cable length	4 m

Scope of delivery	602259500 <sup>1) 2)</sup>	602259000
Order no.		
Side handle	■	■
1 Expansion roller (Ø90x100 mm)	■	
3 Sanding belts (Ø90x100 mm; P80)	■	
1 Fleece grinding wheel (Ø105x100 mm; P280)	■	
1 Flap wheel (Ø105x100 mm; P80)	■	
1 Flap/fleece grinding wheel (Ø105x100 mm; P180)	■	
Metal carry case	■	

<sup>1)</sup> also available in 120 V (North/Latin America)  
<sup>2)</sup> also available in 110 V (UK)

Product advantages

- Powerful burnishing machine for sanding, satin-finishing, brushing and high-gloss polishing of e.g. stainless steel
- Maximum productivity thanks to powerful 1,700 Watt motor and high-performance planetary gear train
- Perfect ergonomics thanks to slim handle area for optimal guidance and low-fatigue working
- Fast and tool-free adjustment of guard and side handle
- Metabo Marathon-motor with patented dust protection for long service life
- Vario Tacho Constamatic (VTC) Full-wave Electronics with Thumbwheel: for working at customised speeds to suit the application material and speeds that remain almost constant, even under load
- Spindle lock and tool-free flange nut for fast accessory change
- Smooth-running, form-fit mounting arbor for a uniform grinding result
- Overload protection: protects the motor from overheating
- Electronic soft start for smooth start-up
- Restart protection: prevents unintentional start-up after power supply interruption
- Auto-stop carbon brushes to protect the motor

System components

Accessories → 186 | Battery packs → 72

18 V



Technical data	Cordless Burnishing Machine S 18 LTX 115
Type of battery pack	Li-Ion / LiHD
Battery pack voltage	18 V
No-load speed	3,000 /min
Spindle threads	M 14
Abrasive tool diameter	100 - 200 mm
Abrasive tool width	50 - 100 mm
Weight (including battery pack)	3.1 kg

Scope of delivery	600154
Order no.	
Side handle	■
Dust filter	■
without battery pack, without charger	■

Product advantages

- Compact cordless burnishing machine for grinding, satin-finish, brushing and high-gloss polishing of e.g. stainless steel
- Robust motor for long service life
- Spindle lock and tool-free flange nut for fast accessory change
- Fast and tool-free adjustment of guard and side handle
- Smooth-running, form-fit roller arbor for a uniform grinding result
- Battery pack can be swivelled for better access in hard to reach places
- Detachable dust protection filter protects motor from coarse particles
- Overload protection: protects the motor from overheating
- Electronic soft start for smooth start-up
- Restart protection: prevents unintentional start-up after power supply interruption

\* Self-service packaging

01

02

03

04

05

06

07

08

09

10

11



12

13

14

15

Expansion rollers

	Order no.
 <p><b>Expansion Roller</b>                      ■ For using sanding belts and abrasive sleeves. The sanding belts/ abrasive sleeves are pushed over the roller and clamped securely by centrifugal force                      Diameter: 90 mm                      Width: 100 mm</p>	623470000
 <p><b>Inflatable expansion roller</b>                      ■ For using sanding belts and abrasive sleeves. The sanding belts/ abrasive sleeves are pushed over the roller. The air volume in the roller is adjusted individually.                      ■ Ideal for easy processing of contours                      Diameter: 90 mm                      Width: 100 mm</p>	623542000

Sanding belts 90 x 100 mm

Diameter mm	Width mm	Grit	Sales unit	Order no.
 <p><b>Sanding belts with zirconia alumina 90x100 mm</b>                      ■ Material: zirconia alumina for grit P 40, 60, 80, 120/ aluminium oxide for grit P 220                      ■ Suitable for all metals and even stainless steel                      ■ For removing scratches and smoothing weld seams                      ■ Only in combination with the expansion roller 623470000                      ■ Maximum working speed: 30 m/s; recommended: 20 m/s</p>				
90	100	P 40	10	623512000
90	100	P 60	10	623473000
90	100	P 80	10	623474000
90	100	P 120	10	623475000
90	100	P 220	10	623476000

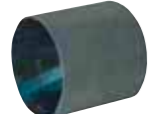
 <p><b>Sanding belts »Metabo Pyramid«, 90 x 100 mm</b>                      ■ For all metal uses, particularly suited to the processing of rust-free steel/stainless steel                      ■ 3-dimensional structure of the grinding media (pyramid-shaped). High material removal with, at the same time, a very even and fine grinding result for the entire lifetime of the product.                      ■ Quick progress; considerably reduces the number of working stages compared to traditional grinding methods.                      ■ Maximum speed: 6,400 /min; recommended speed: 4,200 /min</p>				
90	100	P 120 (A 160)	5	626405000*
90	100	P 280 (A 65)	5	626406000*
90	100	P 400 (A 45)	5	626407000*
90	100	P 600 (A 30)	5	626408000*
90	100	P 1200 (A 16)	5	626409000*
90	100	P 2000 (A 6)	5	626410000*

Fleece sanding sleeves

 <p>■ For removing scratches and oxide layers, tarnishing, satin-finish, deburring and fine grinding                      ■ Only in combination with the expansion roller                      ■ Maximum speed: 6,400 /min; recommended speed: 3,200 /min</p>				
Diameter mm	Width mm	Version	Sales unit	Order no.
90	100	coarse	2	623519000
90	100	medium	2	623495000
90	100	fine	2	623496000

Lamellar grinding wheels

 <p>■ For removing rust, oxide layers, scratches                      ■ For texturing and satin-finish of metal                      ■ Maximum speed: 5,800 /min; recommended speed: 3,200 /min</p>				
Diameter mm	Width mm	Grit	Sales unit	Order no.
105	100	P 40	1	623477000
105	100	P 60	1	623513000
105	100	P 80	1	623479000
105	100	P 120	1	623480000
105	100	P 180	1	623481000
105	100	P 240	1	623482000

Flap wheels/fleece grinding wheels

 <p>■ Pink aluminium oxide grinding lamellae combined with grain-coated nylon web                      ■ For tarnishing, satin-finish and removing scratches on metal                      ■ Removing old paint and smoothing wood materials                      ■ Maximum speed: 5,600 /min; recommended speed: 2,900 /min</p>				
Diameter mm	Width mm	Grit	Sales unit	Order no.
105	100	P 60	1	623483000
105	100	P 80	1	623484000
105	100	P 180	1	623485000
105	50	P 60	1	623526000
105	50	P 80	1	623527000
105	50	P 180	1	623528000

Fleece grinding wheels

 <p>■ Elastic grain-coated nylon web for shadow-free tarnishing, satin-finish and polishing of special steel and non-ferrous metals                      ■ For use on wood to smooth surfaces                      ■ Maximum speed: 5,600 /min; recommended speed: 2,900 /min, Ø 115 mm: 2,600 /min</p>				
Diameter mm	Width mm	Grit	Sales unit	Order no.
105	100	P 60	1	623486000
105	100	P 80	1	623487000
105	100	P 180	1	623488000
105	100	P 280	1	623514000
115	100	P 400	1	623468000
115	100	P 600	1	623469000
115	100	P 900	1	623494000

Corrugated fleece sanding/Grinding wheel

 <p>■ For transition-free matt and satin-finishes on stainless steel surfaces and non-ferrous metals                      ■ For removing minor scratches and for cleaning surfaces                      ■ Elastic nylon fleece containing grit with a corrugated arrangement on the core                      ■ Maximum speed: 5,900 /min; recommended speed: 3,000 /min</p>				
Diameter mm	Width mm	Grit	Sales unit	Order no.
100	100	P 180	1	623567000

\* Self-service packaging

Hard fleece grinding wheel



- For cleaning and descaling weld seams
- Removing rust, oxide layers and paint
- Strong longitudinal grinding of stainless steel
- Maximum speed: 5,400 /min; recommended speed: 2,800 /min

Diameter mm	Width mm	Grit	Sales unit	Order no.
110	100	P 46	1	623525000

Rubber grinding wheels



- Rubber mix with silicone carbide abrasive grains
- For removing small scratches. For bright shining, decorative longitudinal grinding of stainless steel and non-ferrous metals
- Maximum speed: 2,700 /min; recommended speed: 1,400 /min

Diameter mm	Width mm	Grit	Sales unit	Order no.
105	100	P 60	1	623510000
105	100	P 180	1	623499000

Polishing discs



- Sisal polishing rings**
- For pre-polishing steel and stainless steel in conjunction with the white polishing paste 623520000
  - Maximum speed: 6,100 /min; recommended speed: 1,900 /min
- Diameter: 100 mm  
Width: 15 mm  
Version: impregnated  
Sales unit: 5

Order no.  
623507000



- Nylon web polishing rings**
- For pre-polishing non-ferrous steel in conjunction with the brown polishing paste 623522000
  - Maximum speed: 6,100 /min; recommended speed: 1,900 /min
- Diameter: 100 mm  
Width: 10 mm  
Version: hard  
Sales unit: 8

Order no.  
623508000



- Nylon web polishing rings**
- For high-gloss polishing of all metals in conjunction with the blue polishing paste 623524000
  - Maximum speed: 6,100 /min; recommended speed: 1,900 /min
- Diameter: 100 mm  
Width: 10 mm  
Version: soft  
Sales unit: 8

Order no.  
623509000

Polishing pastes



- Polishing paste, white**
- For pre-polishing and polishing stainless steel
- Weight: 250 g

Order no.  
623520000



- Polishing paste, brown**
- For pre-polishing and polishing non-ferrous metals
- Weight: 250 g

Order no.  
623522000



- Polishing paste, blue**
- For high-gloss polishing of all metals
- Weight: 250 g

Order no.  
623524000

Steel-wire wheel brushes

- For rust removal, deburring and cleaning metal
- For brushing out soft annual rings on wood
- Maximum speed: 6,000 /min; recommended speed: 3,000 - 4,500 /min

Diameter mm	Width mm	Wire thickness	Order no.
100	70	0.27 mm	623501000



Steel-wire wheel brushes, Inox

- With stainless wire. For cleaning weld seams, deburring, rust removal, roughening
- Maximum speed: 6,000 /min; recommended speed: 2,400 - 3,900 /min

Diameter mm	Width mm	Wire thickness	Order no.
100	70	0.20 mm	623503000



Plastic wheel brushes

- Elastic, grain-coated wheel brush for roughening and deburring metal
- For rustic effects on wood
- Maximum speed: 6,000 /min; recommended speed: 2,400 - 3,900 /min

Diameter mm	Width mm	Order no.
100	70	623505000



Fibre wheel brush

- For use on all wood materials. For polishing etched wood materials.
- For producing a dull finish. Dust removal and cleaning.
- Maximum speed: 6,000 /min; recommended speed: 2,400 - 3,900 /min

Diameter mm	Width mm	Order no.
100	100	623506000



Spacer rings

- 3 Spacer rings**
- For width compensation when using grinding rollers, brushes, polishing rings



Order no.  
623511000

**Sanding belt**



**Sanding belt**

- With corrugated surface for non-slip work with sanding belts, nylon web and felt band

Diameter: 85 mm  
Width: 70 mm

	Order no.
	623529000

**Adhesive tape**



**Adhesive tape**

- For re-closing the sanding belts

	Order no.
	623530000

**Fleece bands**



- For fine grinding or polishing, also on "closed" pipe constructions
- Resealable by "buttonhole closure"
- Only in conjunction with sanding belt 623529000

Length mm	Width mm	Version	Sales unit	Order no.
660	30	Coarse	3	623536000
660	30	medium	3	623537000
660	30	fine	3	623538000
660	30	extra fine	3	623539000

**Felt band**



**Felt band**

- For polishing work, also on "closed" pipe constructions
- Can be used on both sides
- Resealable by "buttonhole closure"
- Only in conjunction with sanding belt 623529000

Length: 600 mm  
Width: 30 mm  
Sales unit: 1

	Order no.
	623541000

**Guard 50 mm incl. mounting arbor**



- The guard and the mounting arbor have been specially designed for use with 50 mm wide lamellar / fleece grinding discs and fleece grinding wheels. This permits working near edges.

	Order no.
Guard 50 mm incl. mounting arbor 5/8"	626413000
Guard 50 mm incl. mounting arbor M 14	626414000

**Stainless steel adhesive tape**



**Stainless steel adhesive tape**

- For mitre cuts of welded stainless steel profiles.
- Dimensions: 2.5 m x 40 x 0.15 mm

	Order no.
	626376000

**Micro-fibre cloth**



**3 Micro-fibre cloths 380 x 380 mm**

- For cleaning and evenly distributing protective media and polishes, for removing pastes and cream residue
- Suitable for all metals and hard plastics

	Order no.
	626398000*

**Stainless steel cleaning spray**



**Stainless steel cleaning spray 400 ml**

- For cleaning, conserving and sealing of surfaces, especially on stainless steels.

	Order no.
	626377000

**Vienna lime chalk**



**Vienna lime chalk**

- For cleaning, caring and polishing of smooth surfaces, especially stainless steel, silver, brass, glass, ceramic etc.
- Contents: 300 g, shaker

	Order no.
	626399000

\* Self-service packaging





18 V



Technical data	Tube Belt Sander RBE 9-60 Set
Rated input power	900 W
Output power	470 W
Belt speed in idle	8 - 14 m/s
Grinding belt dimensions	30 x 533 mm
Maximum pipe diameter	60 mm
Wrap angle	190 °
Weight (without mains cable)	3.1 kg
Cable length	4 m

Scope of delivery	Order no.	602183
10 Sanding belts zirconia (30x533 mm; P80)		■
2 Pyramid sanding belts (30x533 mm; P280/A65)		■
2 Pyramid sanding belts (30x533 mm; P400/A45)		■
2 Pyramid sanding belts (30x533 mm; P600/A30)		■
2 Pyramid sanding belts (30x533 mm; P1200/A16)		■
3 Fleece bands (30x533 mm; medium)		■
Metal carry case		■

- Product advantages**
- Compact tube belt sander with high belt speeds for productive processing of stainless steel pipes
  - Large wrap angle of 190° for smooth surfaces
  - Metabo Marathon-motor with patented dust protection for long service life
  - Thumbwheel controlled Vario-Constamatic (VC)-Full wave electronics ideal for working on materials requiring customised speeds, and at speeds which remain almost constant under load
  - Tool-free sanding belt change and adjustable belt guide
  - Electronic overload protection for long service life
  - Electronic soft start for smooth start-up
  - Restart protection: prevents unintentional start-up after power supply interruption
  - Auto-stop carbon brushes to protect the motor

**System components**

Accessories → 194 | Battery packs → 72

Technical data	Cordless Tube Belt Sander RB 18 LTX 60
Type of battery pack	Li-Ion / LiHD
Battery pack voltage	18 V
Belt speed in idle	9.2 m/s
Grinding belt dimensions	30 x 533 mm
Maximum pipe diameter	60 mm
Wrap angle	190 °
Weight (including battery pack)	3.3 kg

Scope of delivery	Order no.	600192
Dust filter		■
without battery pack, without charger		■

- Product advantages**
- Compact cordless tube belt sander for quick, flexible processing of stainless steel pipes
  - Large wrap angle of 190° for smooth surfaces
  - Robust motor for long service life
  - Tool-free sanding belt change and adjustable belt guide
  - Battery pack can be swivelled for better access in hard to reach places
  - Detachable dust protection filter protects motor from coarse particles
  - Overload protection: protects the motor from overheating
  - Electronic soft start for smooth start-up
  - Restart protection: prevents unintentional start-up after power supply interruption



Technical data	Tube Belt Sander RBE 15-180 Set
Rated input power	1,550 W
Output power	940 W
Belt speed in idle	8.4 - 28 m/s
Grinding belt dimensions	40 x 760 mm
Maximum pipe diameter	180 mm
Wrap angle	270 °
Weight (without mains cable)	3.4 kg
Cable length	4 m

Scope of delivery	Order no.	602243 <sup>1)</sup>
Side handle		■
10 Sanding belts zirconia (40x760 mm; P80)		■
2 Pyramid sanding belts (40x760 mm; P280/A65)		■
2 Pyramid sanding belts (40x760 mm; P400/A45)		■
2 Pyramid sanding belts (40x760 mm; P600/A30)		■
2 Pyramid sanding belts (40x760 mm; P1200/A16)		■
3 Fleece bands (40x760 mm medium)		■
Metal carry case		■

<sup>1)</sup> also available in 120 V (North/Latin America)

- Product advantages**
- Powerful tube belt sander for processing even larger stainless steel pipes
  - Large wrap angle of 270° for smooth surfaces and quick work progress
  - Metabo Marathon-motor with patented dust protection for long service life
  - Vario Tacho Constamatic (VTC) Full-wave Electronics with Thumbwheel: for working at customised speeds to suit the application material and speeds that remain almost constant, even under load
  - Rubberised drive roller: reduces slipping of the sanding belt
  - Tool-free sanding belt change and adjustable belt guide
  - Overload protection: protects the motor from overheating
  - Electronic soft start for smooth start-up
  - Restart protection: prevents unintentional start-up after power supply interruption
  - Auto-stop carbon brushes to protect the motor

**System components**

Accessories → 194

Aluminium oxide sanding belts



- For use throughout the metal industry. Flexible grinding material, dense with stable cotton base.
- Good material removal with good tool life. Uniform grinding result.
- Recommended circumferential speed: 25-35 m/s

Dimensions mm	Grit	Sales unit	Order no.
30 x 533	P 120	10	626279000*
30 x 533	P 180	10	626280000*
30 x 533	P 240	10	626281000*
30 x 533	P 320	10	626282000*
30 x 533	P 400	10	626283000*
40 x 760	P 120	10	626300000*
40 x 760	P 180	10	626301000*
40 x 760	P 240	10	626302000*
40 x 760	P 320	10	626303000*
40 x 760	P 400	10	626304000*

Zirconia alumina sanding belts



- For all metal uses, particularly suited for processing stainless steels/Inox. High performance sanding belt, dense with cotton base.
- High material removal with good service life. Even grinding result.
- For rough-polishing and deburring of steel and stainless steel
- Recommended circumferential speed: 25-35 m/s

Dimensions mm	Grit	Sales unit	Order no.
30 x 533	P 60	10	626284000*
30 x 533	P 80	10	626285000*
30 x 533	P 120	10	626286000*
40 x 760	P 60	10	626305000*
40 x 760	P 80	10	626306000*
40 x 760	P 120	10	626307000*

Ceramic grain sanding belts



- For all metal uses, particularly suited for processing stainless steels/Inox. Flexible high performance sanding belt, semi-open coarseness with cotton base
- Extremely high material removal with extremely high service life thanks to self-sharpening ceramic grain. Uniform grinding result and best sanding results.
- For pre-polishing and fine polishing, for example, of contours, profiles, etc.
- Recommended circumferential speed: 25-35 m/s for stainless steel
- Recommended circumferential speed: 20-30 m/s for NF metals
- Recommended circumferential speed: 5-10 m/s for high temperature Ni-/Co steels

Dimensions mm	Grit	Sales unit	Order no.
40 x 760	P 60	10	626308000*
40 x 760	P 80	10	626309000*
40 x 760	P 120	10	626310000*

»Metabo Pyramid« sanding belts



- For all metal uses, particularly suited to the processing of rust-free steel/stainless steel
- 3-dimensional structure of the grinding media (pyramid-shaped). High material removal with, at the same time, a very even and fine grinding result for the entire lifetime of the product.
- Quick progress; considerably reduces the number of working stages compared to traditional grinding methods.
- Special product for processing of lightly and heavily profiled elements in the stainless steel industry.
- Recommended circumferential speed: 2.7-8.5 m/s

Dimensions mm	Grit	Sales unit	Order no.
30 x 533	P 120 (A 160)	5	626290000*
30 x 533	P 280 (A 65)	5	626291000*
30 x 533	P 400 (A 45)	5	626292000*
30 x 533	P 600 (A 30)	5	626293000*
30 x 533	P 1200 (A 16)	5	626294000*
30 x 533	P 2000 (A6)	5	626295000*
40 x 760	P 120 (A 160)	5	626311000*
40 x 760	P 280 (A 65)	5	626312000*
40 x 760	P 400 (A 45)	5	626313000*
40 x 760	P 600 (A 30)	5	626314000*
40 x 760	P 1200 (A 16)	5	626315000*
40 x 760	P 2000 (A6)	5	626316000*

Fleece bands



- For grinding, cleaning and finishing work. For removing scratches, colour runs and oxide layers.
- For preparing, pre-grinding and polishing weld seams
- Recommended circumferential speed: 25-30 m/s for steel
- Recommended circumferential speed: 15-25 m/s for stainless steel
- Recommended circumferential speed: 30-40 m/s for soft NF metals
- Recommended circumferential speed: 5-15 m/s for high temperature Ni-/ Co alloys

Dimensions mm	Grit	Sales unit	Order no.
30 x 533	Coarse	3	626296000*
30 x 533	medium	3	626297000*
30 x 533	Very fine	3	626298000*
40 x 760	Coarse	3	626319000*
40 x 760	medium	3	626320000*
40 x 760	Very fine	3	626322000*







Felt bands



- For polishing stainless steel and non-ferrous metals, always in conjunction with a polishing paste.
- Recommended circumferential speed: 10-20 m/s

Dimensions mm	Grit	Sales unit	Order no.
30 x 533	Soft	1	626299000*
40 x 760	Soft	1	626323000*

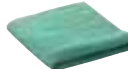
\* Self-service packaging

Polishing pastes		Order no.
	<b>Polishing paste, white</b> ■ For pre-polishing and polishing stainless steel Weight: 250 g	623520000
	<b>Polishing paste, brown</b> ■ For pre-polishing and polishing non-ferrous metals Weight: 250 g	623522000
	<b>Polishing paste, blue</b> ■ For high-gloss polishing of all metals Weight: 250 g	623524000
Additional accessories for tube belt sanders		Order no.
	<b>Vienna lime chalk</b> ■ For cleaning, caring and polishing of smooth surfaces, especially stainless steel, silver, brass, glass, ceramic etc. ■ Contents: 300 g, shaker	626399000
	<b>3 Micro-fibre cloths 380 x 380 mm</b> ■ For cleaning and evenly distributing protective media and polishes, for removing pastes and cream residue ■ Suitable for all metals and hard plastics	626398000*
	<b>Stainless steel cleaning spray 400 ml</b> ■ For cleaning, conserving and sealing of surfaces, especially of stainless steels.	626377000

\* Self-service packaging



## Further Metal Processing

# Die Grinders: Slim line, strong performance.

Wherever metal constructions are created, a robust die grinder is an essential piece of equipment. These innovative power packs offer maximum productivity and precision for all applications. Whether mains-powered or with battery pack - Metabo's die grinders are amongst the slimmest and most compact machines on the market. Numerous safety functions such as the restart protection or the electronic safety shutdown, protect both user and machine.

### Compact and light

With a body circumference of only 195 mm, the new Metabo die grinders are among the slimmest on the market. Although packed with power, the die grinders weigh up to only 1.7 kg



**Vario Tacho Constamatic (VTC) Electronics**  
for working at the optimum setting for the material being processed with speed remaining almost constant under load

### Safety and robustness

Aluminium die-cast bearing flange for long service life of the machine

A removable protective rubber cap ensures comfortable and safe working.



### Highest precision

thanks to hardened and polished precision collet providing accurate concentricity of the tool bit

### Electronic safety shutdown

Immediately switches the machine off should the bit snag

### Metabo Marathon-motor

Robust and resistant thanks to patented dust protection for long service life

GE 950 G Plus



### Uniquely robust and quiet

The new planetary gear train ensures high torque in an extremely compact size.



### Unparalleled productivity: Spindle stop

Lock the gearing by simply pressing a button and change the tool bit without needing a second key.



### Extensive range of accessories

The die grinder can also be optimised as a stationary tool thanks to the tensioning frame and flexible shaft.

# 18 V



### Technical data

	Cordless Die Grinder GA 18 LTX	Cordless Die Grinder GPA 18 LTX	Cordless Die Grinder GA 18 LTX G
Type of battery pack	Li-Ion / LiHD	Li-Ion / LiHD	Li-Ion / LiHD
Battery pack voltage	18 V	18 V	18 V
No-load speed	25,000 /min	25,000 /min	6,000 /min
Collar diameter	43 mm	43 mm	43 mm
Collet chuck bore	6 mm	6 mm	6 mm
Weight (including battery pack)	2.1 kg	2.1 kg	2.2 kg

### Scope of delivery

Order no.	600638	600621 <sup>1)</sup>	600639 <sup>1)</sup>
Collet 6 mm	■	■	■
Protective rubber cap	■	■	■
Dust filter	■	■	■
Open-jawed spanner	■	■	■
2 Li-Power battery packs (18 V/5.2 Ah)	■		
Charger ASC 30-36 V »AIR COOLED«	■		
Plastic carry case	■		
MetaLoc case insert		■	
without battery pack, without charger		■	■
Side handle			■

<sup>1)</sup> also available in 120 V (North/Latin America)

### Product advantages

- Paddle switch with dead man function: safe to operate due to an ergonomically integrated non-slip switch
- High torque and compact design thanks to robust planetary gear train
- Spindle lock for simple change of tools
- Electronic safety shutdown of the motor for safe working in case the tool stops unexpectedly
- Restart protection: prevents unintentional start-up after power supply interruption
- Overload protection: protects the motor from overheating
- Removable protective rubber cap for comfortable and safe working
- Slim design for ideal handling
- Precision collet for precise concentricity
- Battery packs with capacity display for checking the charge status

### System components

Accessories → 202

Battery packs → 72



Technical data	Die Grinder GE 710 Compact	Die Grinder GE 710 Plus	Die Grinder GEP 710 Plus
No-load speed	13,000 - 34,000 /min	10,000 - 30,500 /min	10,000 - 30,500 /min
Rated input power	710 W	710 W	710 W
Output power	430 W	430 W	430 W
Revolutions at rated load	24,000 /min	24,000 /min	24,000 /min
Collar diameter	43 mm	43 mm	43 mm
Collet chuck bore	6 mm	6 mm	6 mm
Weight (without mains cable)	1.4 kg	1.6 kg	1.6 kg
Cable length	4 m	4 m	4 m

Scope of delivery

Order no.	600615 <sup>1)</sup>	600616 <sup>1) 2)</sup>	600617 <sup>1) 2)</sup>
Collet 6 mm	■	■	■
2 open-jawed spanners	■		
Protective rubber cap		■	■
1 Open-jawed spanner		■	■

<sup>1)</sup> also available in 120 V (North/Latin America)  
<sup>2)</sup> also available in 110 V (UK)

Product advantages

- Particularly handy due to compact design
- Long grinding spindle - ideal for working in hard to reach places
- Spindle lock for simple change of tools
- Aluminium die-cast bearing flange for long service life of the machine
- Removable protective rubber cap for comfortable and safe working
- Vario Constamatic (VC) Electronics for work with materials requiring customised speeds, which remain almost constant under load
- Thumbwheel for speed preselection
- Electronic safety shutdown of the motor for safe working in case the tool stops unexpectedly
- Restart protection: prevents unintentional start-up after power supply interruption
- Electronic overload protection for long service life
- Precise collar for stationary use
- Slim design for ideal handling
- Precision collet for precise concentricity
- Metabo Marathon-motor with patented dust protection for long service life
- Long grinding spindle - ideal for working in hard to reach places
- Spindle lock for simple change of tools
- Aluminium die-cast bearing flange for long service life of the machine
- Removable protective rubber cap for comfortable and safe working
- Paddle switch with dead man function: safe to operate due to an ergonomically integrated non-slip switch

System components

Accessories → 202



Technical data	Die Grinder GE 950 G Plus	Die Grinder GEP 950 G Plus
No-load speed	2,500 - 8,700 /min	2,500 - 8,700 /min
Rated input power	950 W	950 W
Output power	510 W	510 W
Revolutions at rated load	7,200 /min	7,200 /min
Collar diameter	43 mm	43 mm
Collet chuck bore	6 mm	6 mm
Weight (without mains cable)	1.7 kg	1.7 kg
Cable length	4 m	4 m

Scope of delivery

Order no.	600618 <sup>1) 2)</sup>	600627 <sup>1) 2)</sup>
Collet 6 mm	■	■
Protective rubber cap	■	■
Side handle	■	■
1 Open-jawed spanner	■	■

<sup>1)</sup> also available in 120 V (North/Latin America)  
<sup>2)</sup> also available in 110 V (UK)

Product advantages

- Paddle switch with dead man function: safe to operate due to an ergonomically integrated non-slip switch
- High torque and compact design thanks to robust planetary gear train
- Spindle lock for simple change of tools
- Aluminium die-cast bearing flange for long service life of the machine
- Vario Constamatic (VC) Electronics for work with materials requiring customised speeds, which remain almost constant under load
- Thumbwheel for speed preselection
- Electronic safety shutdown of the motor for safe working in case the tool stops unexpectedly
- Restart protection: prevents unintentional start-up after power supply interruption
- Electronic overload protection for long service life
- Precise collar for stationary use
- Removable protective rubber cap for comfortable and safe working
- Slim design for ideal handling
- Precision collet for precise concentricity
- Metabo Marathon-motor with patented dust protection for long service life
- The specialist: handy grinder with especially high torque; ideal for grinding inner and outer surfaces in combination with flap wheels (see Accessories)

System components

Accessories → 202

# Ready for any application: System solutions for die grinders.

Whether you remove fine burrs or want to grind surfaces in hard to reach places, we have the right die grinder for you. The machines impress with their slim design and details, like for example, the spindle lock for easy and fast tool change. An extensive range of accessories, compliment the different die grinders, permitting precise and safe working in the different application areas.

**Flexible shafts**



Order no. 627609000



Order no. 630980000

**Tensioning frame**



Order no. 628329000



**High speed**



GE 710 Compact  
Order no. 600615



GE 710 Plus  
Order no. 600616



GA 18 LTX  
Order no. 600638

**High torque**



GE 950 G Plus  
Order no. 600618



GA 18 LTX G  
Order no. 600639

**Carbide cutter**



**Corundum Mounted Points**



See page 207

**Flap wheels**



See page 208

## Carbide Rotary Burrs

- Carbide head made from high-quality carbide with a percentage of Cobalt
- Specially hardened steel shaft
- Special copper soldering material for a safe connection
- 100% control of the soldering joint

### Design wave shape

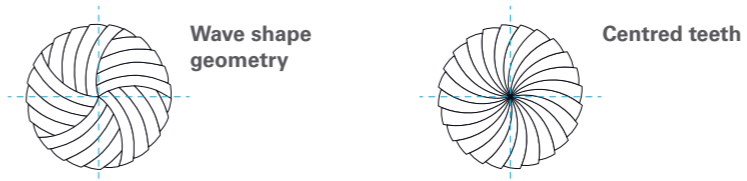

Carbide router bits with round spur cutting edges are produced with a wave geometry; this results in improved ease of cutting at the end of the tool.

### Shapes and applications at a glance



### Recommended cutting speeds for different material groups:

Material groups		Gearing	Cutting speed
Steel and die-cast materials	unhardened, non-heat treated steels up to 1,200 N/mm² (< 35 HRC)	Cross-cut gearing MX	450 - 600 m/min
	hardened, heat-treated steels over 1,200 N/mm (>35 HRC)	Cross-cut gearing MX	250 - 350 m/min
Stainless steels	Stainless steels resistant to rust and acid	Cross-cut gearing MX	250 - 350 m/min
NF Metals	soft NF metals	Aluminium gearing ALU	600 - 900 m/min
	High temperature-resistant materials	Cross-cut gearing MX	300 - 450 m/min
Cast iron materials	Grey cast iron Ductile cast iron	Cross-cut gearing MX	450 - 600 m/min

**Example:** Material group: Stainless steel  
Gearing: cross / MX  
Cutter head Ø 8 mm  
Cutting speed: 250 - 350 m/min  
**Recommended speed range: 10,000 - 14,000 /min**

### Recommended speed range:

Head Ø (mm)	Cutting speeds (m/min)					
	250	300	350	450	600	900
6	13,000	16,000	19,000	24,000	32,000	
8	10,000	12,000	14,000	18,000	24,000	
9.6	8,000	10,000	12,000	15,000	20,000	
12.7	6,000	7,500	9,000	11,000	15,000	23,000

### Always the right collet for your accessories

For die grinders		For flexible shaft 630980000		For flexible shaft 627609000	
Collet bore	Order no.	Collet bore	Order no.	Collet bore	Order no.
6 mm	630820000	6 mm	630977000	6 mm	630714000
8 mm	631946000	8 mm	630979000	3 mm	630715000
3 mm	631947000	3 mm	630976000		
1/8" (3.18 mm)	631948000				
1/4" (6.35 mm)	631949000				

Rotary Burs

Carbide rotary burs

- Carbide burs with cross-cut gearing for general applications. The cross-cut gearing permits comfortable working and better control. Thanks to the improved ease of cutting, the material removal is increased. Suitable for almost all metals, such as hardened and unhardened steel, stainless steel, titanium, brass, copper, cast iron, bronze.
- Application examples: Deburring, machining of contours, processing of surfaces, milling of hard to reach places, machining of narrow angles

	Head Ø mm	Working length mm	Overall length mm	Shaft Ø mm	Gearing	Order no.
<b>Cylindrical rotary burs, ZYAS shape (with spur gearing)</b> For general applications. Ideally suited for inner contours.						
<b>ZYAS</b>	6	18	50	6	Cross-cut gearing	628341000*
	8	20	64	6	Cross-cut gearing	628342000*
	10	20	64	6	Cross-cut gearing	628343000*
	12	25	70	6	Cross-cut gearing	628344000*
<b>Radius end rotary burs, WRC shape</b> For processing surfaces, contours and radii.						
<b>WRC</b>	6	18	50	6	Cross-cut gearing	628345000*
	8	20	64	6	Cross-cut gearing	628346000*
	10	20	64	6	Cross-cut gearing	628347000*
	12	25	70	6	Cross-cut gearing	628348000*
<b>Rotary burs, ball shape, KUD shape</b> To process contours and deburring of internal bores. Particularly for milling in hard to reach areas.						
<b>KUD</b>	6	5	50	6	Cross-cut gearing	628349000*
	8	6	52	6	Cross-cut gearing	628350000*
	10	8	54	6	Cross-cut gearing	628351000*
	12	11	56	6	Cross-cut gearing	628352000*
<b>Rotary burs, drop shape, TRE shape</b> For general applications.						
<b>TRE</b>	6	10	50	6	Cross-cut gearing	628372000*
	8	15	60	6	Cross-cut gearing	628373000*
	10	16	60	6	Cross-cut gearing	628402000*
	12	22	67	6	Cross-cut gearing	628374000*
<b>Rotary burs, semi-circular shape, RBF shape</b> For processing narrow workpieces.						
<b>RBF</b>	6	18	50	6	Cross-cut gearing	628353000*
	8	20	65	6	Cross-cut gearing	628354000*
	10	20	64	6	Cross-cut gearing	628355000*
	12	25	70	6	Cross-cut gearing	628356000*
<b>Rotary burs, pointed arch shape, SPG shape</b> For the processing of acute angles.						
<b>SPG</b>	6	18	50	6	Cross-cut gearing	628357000*
	8	20	64	6	Cross-cut gearing	628358000*
	10	20	64	6	Cross-cut gearing	628359000*
	12	25	70	6	Cross-cut gearing	628360000*
<b>Rotary burs flame shape, B shape</b> For general applications.						
<b>B</b>	6	14	50	6	Cross-cut gearing	628361000*
	8	20	64	6	Cross-cut gearing	628362000*
	10	20	65	6	Cross-cut gearing	628363000*
	12	32	77	6	Cross-cut gearing	628364000*

	Head Ø mm	Working length mm	Overall length mm	Shaft Ø mm	Gearing	Order no.
<b>Rotary burs round taper shape, KEL shape</b> For processing hard to reach areas.						
<b>KEL</b>	6	18	50	6	Cross-cut gearing	628401000*
	8	25	70	6	Cross-cut gearing	628365000*
	10	30	76	6	Cross-cut gearing	628366000*
	12	32	77	6	Cross-cut gearing	628367000*

	Head Ø mm	Working length mm	Overall length mm	Shaft Ø mm	Gearing	Order no.
<b>Rotary burs, pointed cone shape, SKM shape</b> For processing hard to reach areas. Ideally suited for model construction. The conical shape permits the cutting of continuous diameters.						
<b>SKM</b>	6	20	50	6	Cross-cut gearing	628368000*
	8	18	64	6	Cross-cut gearing	628369000*
	10	20	64	6	Cross-cut gearing	628370000*
	12	22	71	6	Cross-cut gearing	628371000*

	Head Ø mm	Working length mm	Overall length mm	Shaft Ø mm	Gearing	Order no.
<b>Radius rotary burr</b> Unparalleled radius router burr with special curved structure. The specially developed guide system prevents the cutter sliding off the work piece. Therefore it is ideally suited for fine radii at sharp corners/edges and good control over sharp edges. The special groove geometry (overlapping standard gearing in the bit centre) permits fine milling on all surfaces and quick material removal with long service life. The smooth face side helps guiding the cutter and protects the surface from damage. Specially developed for achieving radius chamfers in hard materials such as steel, stainless steel, cast iron, titanium, bronze, copper, brass, etc.						
<b>R</b>	12	16	70	6	Simple gearing	628378000*

Carbide rotary burs for aluminium



- Carbide burr with special aluminium gearing for processing soft, long-chip materials such as aluminium and plastics. The aluminium gearing permits a high chip removal rate and high cutting performance with smooth operation.
- Application examples: Deburring, machining of contours, processing of surfaces, milling of hard to reach places, machining of narrow angles

	Head Ø mm	Working length mm	Overall length mm	Shaft Ø mm	Gearing	Order no.
<b>Cylindrical rotary burr, ZYAS shape/ Alu (with spur gearing)</b> Ideal for inside contours and general applications						
<b>ZYAS</b>	12	25	70	6	Aluminium gearing	628375000*
<b>Rotary burr, radius end, WRC shape/ Alu</b> For processing surfaces, contours and radii						
<b>WRC</b>	12	25	70	6	Aluminium gearing	628377000*
<b>Rotary burr, spherical shape, KUD shape/ Alu</b> For processing contours and deburring of internal bores						
<b>KUD</b>	12	11	56	6	Aluminium gearing	628376000*

\* Self-service packaging

Carbide burr sets







- Carbide burrs with cross-cut gearing for general applications. The cross-cut gearing permits comfortable working and better control. Thanks to the improved ease of cutting, the material removal is increased. Suitable for almost all metals, such as hardened and unhardened steel, stainless steel, titanium, brass, copper, cast iron, bronze.
- Application examples: Deburring, machining of contours, processing of surfaces, milling of hard to reach places, machining of narrow angles

	Order no.
 <p><b>Carbide burr set</b> Contents: 1 x Order no.: head-Ø x working length x overall length, shaft-Ø, shape 1 x 628343000: ZYAS 102064, cylinder / B-shape 1 x 628347000: WRC 102064, radius end/C shape 1 x 628351000: KUD 100854, sphere/D shape 1 x 628402000: TRE 101660, ellipse/E shape 1 x 628359000: SPG 102064, pointed arch/G shape</p>	628403000*
 <p><b>Carbide burr set</b> Contents: 1 x Order no.: head-Ø x working length x overall length, shaft-Ø, shape 1 x 628343000: ZYAS 102064, cylinder / B-shape 1 x 628344000: ZYAS 122570, cylinder / B-shape 1 x 628347000: WRC 102064, radius end/C shape 1 x 628348000: WRC 122570, radius end/C shape 1 x 628352000: KUD 121156, sphere/D shape 1 x 628402000: TRE 101660, ellipse/E shape 1 x 628356000: RBF 122570, round arch/F shape 1 x 628359000: SPG 102064, pointed arch/G shape 1 x 628360000: SPG 122570, pointed arch/G shape 1 x 628367000: KEL 123277, round cone/L shape</p>	628404000*
 <p><b>Carbide burr display</b> Contents: 2 x Order no.: head-Ø x working length x overall length, shaft-Ø, shape 2 x 628341000: ZYAS 061850, cylinder / B-shape 2 x 628345000: WRC 061850, radius end/C shape 2 x 628353000: RBF 061850, round arch/F shape 2 x 628357000: SPG 061850, pointed arch/G shape 2 x 628401000: KEL 061850, round cone/L shape 2 x 628346000: WRC 082064, radius end/C shape 2 x 628354000: RBF 082065, round arch/F shape 2 x 628358000: SPG 082064, pointed arch/G shape 2 x 628365000: KEL 082570, round cone/L shape 2 x 628343000: ZYAS 102064, cylinder / B-shape 2 x 628347000: WRC 102064, radius end/C shape 2 x 628355000: RBF 102064, round arch/F shape 2 x 628359000: SPG 102064, pointed arch/G shape 2 x 628366000: KEL 103076, round cone/L shape 2 x 628344000: ZYAS 122570, cylinder / B-shape 1 x 628348000: WRC 122570, radius end/C shape 2 x 628356000: RBF 122570, round arch/F shape 2 x 628360000: SPG 122570, pointed arch/G shape 2 x 628367000: KEL 123277, round cone/L shape 2 x 628402000: TRE 101660, ellipse/E shape</p>	628405000

Corundum Mounted Points



Mounted points made of pink aluminium oxide

- Mounted points made from pink aluminium oxide for steel and cast steel
- For the preparation of weld seams, processing of weld seams
- Rough machining to fine processing
- For deburring and buffing

	Head Ø mm	Working length mm	Overall length mm	Shaft Ø mm	Grit	Order no.
	16	32	40	6	K 46	628330000*
	25	25	40	6	K 36	628331000*
	16	32	40	6	K 46	628332000*
	25	25	40	6	K 36	628333000*
	20	32	40	6	K 36	628334000*
 <p><b>Mounted points made from pink aluminium oxide in a set</b>  <ul style="list-style-type: none"> <li>■ Mounted points made from pink aluminium oxide for steel and cast steel</li> <li>■ Ideal for the preparation of weld seams, processing of weld seams</li> <li>■ Rough machining to fine processing</li> <li>■ Deburring</li> <li>■ Plastering</li> </ul>                     Contents: 1 x Order no.: head-Ø x working length x shaft length, shaft-Ø, grit, shape                      1 x 628330000: 16 x 32 x 40 mm, 6 mm, K 46, Cylinders                      1 x 628331000: 25 x 25 x 40 mm, 6 mm, K 36, Cylinders                      1 x 628332000: 16 x 32 x 40 mm, 6 mm, K 46, Taper                      1 x 628333000: 25 x 25 x 40 mm, 6 mm, K 36, Ball                      1 x 628334000: 20 x 32 x 40 mm, 6 mm, K 36, Pointed arch</p>						628335000*

Mounted points made of aluminium oxide

- Mounted points made of aluminium oxide for processing stainless steel, Inox, NK 24 N BA, soft version, free from iron and sulphur
- For the preparation of weld seams, processing of weld seams
- Rough machining to fine processing
- For deburring and buffing

	Head Ø mm	Working length mm	Overall length mm	Shaft Ø mm	Grit	Order no.
	20	32	40	6	K 24	628336000*
	25	32	40	6	K 24	628337000*
	32	32	40	6	K 24	628338000*
	40	20	40	6	K 24	628339000*
	50	10	40	6	K 24	628340000*

\* Self-service packaging



Flap Wheels



- Aluminium oxide flap wheels
- For processing profiled workpieces, inner surfaces, narrow and hard to reach areas. Particularly for radial use.
- Ideal for smoothing, rust removal, buffing, deburring; rough grinding of steel; processing of steel surfaces; tarnishing; flat surface grinding; effect grinding

Diameter x width mm	Shaft Ø mm	Grit	Maximum speed /min	Sales unit	Order no.
Ø 50 x 20	6	P 40	15,200	1	628379000*
Ø 50 x 20	6	P 60	15,200	1	631110000*
Ø 50 x 20	6	P 80	15,200	1	628380000*
Ø 60 x 20	6	P 40	12,700	1	628381000*
Ø 60 x 20	6	P 60	12,700	1	628382000*
Ø 60 x 20	6	P 80	12,700	1	628383000*
Ø 60 x 30	6	P 40	12,700	1	628384000*
Ø 60 x 30	6	P 60	12,700	1	631111000*
Ø 60 x 30	6	P 80	12,700	1	628385000*
Ø 60 x 30	6	P 120	12,700	1	628386000*
Ø 60 x 30	6	P 180	12,700	1	628387000*
Ø 60 x 30	6	P 240	12,700	1	628388000*
Ø 60 x 40	6	P 40	12,700	1	628389000*
Ø 60 x 40	6	P 60	12,700	1	631112000*
Ø 60 x 40	6	P 80	12,700	1	628390000*
Ø 80 x 30	6	P 40	9,500	1	628391000*
Ø 80 x 30	6	P 60	9,500	1	628392000*
Ø 80 x 30	6	P 80	9,500	1	628393000*
Ø 80 x 30	6	P 120	9,500	1	628394000*
Ø 80 x 40	6	P 40	9,500	1	628395000*
Ø 80 x 40	6	P 60	9,500	1	628396000*
Ø 80 x 40	6	P 80	9,500	1	628397000*
Ø 80 x 50	6	P 40	9,500	1	628398000*
Ø 80 x 50	6	P 60	9,500	1	628399000*
Ø 80 x 50	6	P 80	9,500	1	628400000*

Small Grinding Discs

Quality class A 24-Q »Flexiamant Super« steel



- Universal disc for all aspects of metal processing, particularly suitable for deburring and grinding edges, also for cast processing
- Hardness: hard
- Good material removal with extremely good tool life

Diameter x thickness x bore mm	Maximum speed /min	Maximum working speed m/s	Sales unit / packing unit	Suitable for machine	Order no.
50 x 6 x 6	30,600	80	1/25		630187000

Small Cutting Discs

Quality class A 46-U 9 »Flexiamant Super« Inox



- High-output disc especially for processing stainless steel
- Maximum cutting output with very long tool life by using special corundums. Free from iron, sulphur and chlorine (Fe + S + Cl ≤ 0.1 %), for all rust and acid resistant steels (V2A, Nirosta, INOX), spring steels, tool steels
- For use in the manufacture of vehicles, containers, car bodies, switch cabinets etc. Cutting discs for quiet, precise cutting cuts without burrs
- Hardness: hard

Diameter x thickness x bore mm	Maximum speed /min	Maximum working speed m/s	Sales unit / packing unit	Suitable for machine	Order no.
50 x 1 x 6	30,600	80	1/50		630191000
50 x 2 x 6	30,600	80	1/25		630192000
76 x 2 x 6	20,100	80	1/25		630194000
76 x 1.1 x 6	20,100	80	1/50		630195000
Mounting arbor for small cutting discs					630189000*

Collets for die grinder



Collet bore	Version	Order no.
3 mm	hexagon	631947000*
1/8" (3.18 mm)	hexagon	631948000*
6 mm	hexagon	631945000*
6 mm	double flat	630820000
8 mm	double flat	630833000
8 mm	hexagon	631946000*
1/4" (6.35 mm)	double flat	631949000

Flexible shafts



Flexible shaft 27609

- Suitable for speeds of 20,000 to 30,000 rpm
- Bearing-mounted at both ends
- For router bits, mounted points, flap wheels etc. with 6 mm shaft diameter. Interchangeable collet for accessories with 3 mm shaft diameter available as accessory (630715000)
- 6 mm driving shaft for fixing the flexible shaft in the collet bore of the drive machine. If the collet bore of the drive machine has a different dimension than 6 mm, the collet of the drive machine must be changed. 6 mm collet available as accessory (631945000)

suitable for routers: FME 737  
 suitable for die grinders: G 500, GE 700, GE 710 Compact, GE 710 Plus  
 Length: 1.3 m  
 Driving shaft: 6 mm  
 Collet bore: 6 mm  
 Weight: 0.8 kg

Order no.  
627609000\*



Flexible shaft 30980

- Suitable for speeds of 7,500 to 30,000 rpm
- Bearing-mounted at both ends
- For router bits, mounted points, flap wheels etc. with 8 mm shaft diameter. Interchangeable collet for accessories with 6 mm shaft diameter (630977000) and 3 mm shaft diameter (630976000) available as accessory
- 8 mm driving shaft for fixing the flexible shaft in the collet bore of the drive machine. If the collet bore of the drive machine has a different dimension than 8 mm, the collet of the drive machine must be changed. 6 mm collet available as accessory (631945000)

suitable for routers: FME 737  
 suitable for die grinders: G 500, GE 700, GE 900 Plus, GE 710 Compact, GE 710 Plus, GE 950 G Plus  
 Length: 1.3 m  
 Driving shaft: 8 mm  
 Collet bore: 8 mm  
 Weight: 0.8 kg

630980000\*

\* Self-service packaging

Collets for flexible shaft 630980000



- To attach the carbide router bits, mounted points etc. to the flexible shaft

Collet bore	Order no.
3 mm	630976000
6 mm	630977000
8 mm	630979000



Collets for flexible shaft 627609000



- To attach the carbide router bits, mounted points etc. to the flexible shaft

Collet bore	Order no.
3 mm	630715000
6 mm	630714000

Additional Accessories for Die Grinders

	Order no.
 <p><b>Tensioning frame</b></p> <ul style="list-style-type: none"> <li>■ Tensioning frame for working with a flexible shaft</li> <li>■ The Metabo tensioning frame with hard rubber can be set up or hung up, is non-slip, stable and protects delicate surfaces from scratches.</li> <li>■ Suitable for GE 710 Plus, GE 950 G Plus, GA 18 LTX, GA 18 LTX G</li> </ul>	628329000
 <p><b>Clamping stand</b></p> <ul style="list-style-type: none"> <li>■ For safe clamping of drills and impact drills as well as die grinders and the motor of the router when working with flexible shafts. Aperture Ø 43 mm. The clamp (627107000) serves for the secure fixing.</li> </ul>	627354000*
 <p><b>Clamp</b></p> <ul style="list-style-type: none"> <li>■ For the secure fixing on a work table</li> </ul>	627107000*

# Metabo bevelling tools: Fast and clean processing of edges.

Metabo bevelling tools are the ideal solution when it comes to breaking sharp edges, prepare visible edges or carry out a weld seam preparation. The new machines are extremely powerful with a chamfer height of up to 15 mm (at 45°). The KFM 18 LTX 3 RF are also the most powerful 18 Volt battery pack bevelling tool on the market for chamfers of up to 4 mm and radii of up to 3 mm.

**Patented one-touch controller**  
Fast and precise cutting depth setting without tools thanks to 0.1 mm stop points in patented one-touch controller.



**KFM 15-10 F**



**Reduced operating cost**  
by using only one milling head for all chamfer angles seamlessly from 0 - 90°

**Front handle**  
for safe and uniform guidance when milling, adjustable without the need for tools

**High surface quality, precise chamfer angles - optimum work results**



With bevelling tool      With angle grinder

Bevelling Tool KFM 16-15 F

**5x more edges bevelled in the same period of time**

2,600 Watt angle grinders

Material: construction steel (S235JR) chamfer 15 mm x 45°

Machine	Milling geometry	Maximum chamfer height			adjustable chamfer angle	Application
		at 15°	at 30°	at 45°		
KFM 9-3 RF	Chamfer and radius	-	-	4 mm	45°	<ul style="list-style-type: none"> <li>■ Deburring of sheet metal with many contours</li> <li>■ Chamfering of pipes</li> <li>■ Chamfering and rounding of drilled and punched edges</li> </ul>
KFM 18 LTX 3 RF	Chamfer and radius	-	-	4 mm	45°	
KFM 15-10 F / KFM 15-10 F	Chamfer	22.5 mm	15 mm	10 mm	0 - 90°	<ul style="list-style-type: none"> <li>■ Weld seam preparation flat material</li> <li>■ Weld seam preparation pipes</li> </ul>
KFM 16-15 F	Chamfer	28 mm	23 mm	15 mm	0 - 90°	

\* Self-service packaging

01  
02  
03  
04  
05  
06  
07  
08  
09  
10  
11  
12  
13  
14  
15

18 V



Technical data	Cordless Bevelling Tool KFM 18 LTX 3 RF
Type of battery pack	Li-Ion / LiHD
Battery pack voltage	18 V
No-load speed	7,000 /min
Type of edges	Chamfer and radius
Max. chamfer width 45°	6 mm
Max. chamfer height at 45°	4 mm
Possible radii	R2 / R3
Grading of cutting depth setting	0.1 mm
Curves smallest internal Ø	13 mm
Weight (including battery pack)	3.1 kg

Scope of delivery

Order no.	601754 <sup>1)</sup>
2 Carbide indexable inserts 45° chamfer	■
2 Carbide indexable inserts radius R2	■
2 Carbide indexable inserts radius R3	■
Guide stop	■
Screwdriver Torx 15	■
Front handle	■
Dust filter	■
2 LiHD battery packs (18 V/5.5 Ah)	■
Charger ASC 30-36 V »AIR COOLED«	■
MetaLoc case	■

<sup>1)</sup> also available in 120 V (North/Latin America)

Product advantages

- The most powerful cordless metal bevelling tool for 45° chamfers up to 4 mm and radii of 2 and 3 mm
- Surfaces free from oxide and burrs as ideal preparation for the application of powder or paint coatings for maximum protection from corrosion
- One-touch controller: Patented, tool-free setting of the cutting depth in 0.1 steps; stop points for short setting times, and protection against unintentional adjustment of the cutting depth when working
- Slim milling head for working on tubes, on bores from Ø 13 mm, and on exterior contours
- Parallel guide / rip fence for a uniform finish when processing straight edges
- Battery pack can be swivelled for better access in hard to reach places
- Overload protection: protects the motor from overheating
- Electronic soft start for smooth start-up
- Restart protection: prevents unintentional start-up after power supply interruption
- Detachable dust protection filter protects motor from coarse particles

System components

Accessories → 214 | Battery packs → 72



Technical data	Bevelling Tool KFM 9-3 RF
No-load speed	4,500 - 11,500 /min
Rated input power	900 W
Output power	470 W
Type of edges	Chamfer and radius
Max. chamfer width 45°	6 mm
Max. chamfer height at 45°	4 mm
Possible radii	R2 / R3
Grading of cutting depth setting	0.1 mm
Curves smallest internal Ø	13 mm
Weight (without mains cable)	2.5 kg
Cable length	4 m

Scope of delivery

Order no.	601751 <sup>1) 2)</sup>
2 carbide indexable inserts 45° chamfer (ISO: DCMT 11 T 304)	■
2 Carbide indexable inserts radius R2	■
2 Carbide indexable inserts radius R3	■
Guide stop	■
Screwdriver Torx 15	■
Front handle	■
MetaLoc case	■

<sup>1)</sup> also available in 120 V (North/Latin America)

<sup>2)</sup> also available in 110 V (UK)

Product advantages

- Compact metal bevelling tool for 45° chamfers and radii of 2 to 3 mm at visible edges
- Surfaces free from oxide and burrs as ideal preparation for the application of powder or paint coatings for maximum protection from corrosion
- One-touch controller: Patented, tool-free setting of the cutting depth in 0.1 steps; stop points for short setting times, and protection against unintentional adjustment of the cutting depth when working
- Slim milling head with standard carbide indexable inserts and ball bearing stationary seal ring for working in pipes and on curves
- Guide stop for a uniform finish and high quality surface finish when processing straight sheets
- Metabo Marathon-motor with patented dust protection for long service life
- Thumbwheel controlled Vario-Constamatic (VC)-Full wave electronics ideal for working on materials requiring customised speeds, and at speeds which remain almost constant under load
- Electronic safety shutdown of the motor for safe working in case the tool stops unexpectedly
- Electronic overload protection, soft start and restart protection

Technical data

Technical data	Bevelling Tool KFM 15-10 F	Bevelling Tool KFMPB 15-10 F	Bevelling Tool KFM 16-15 F
No-load speed	7,800 - 12,200 /min	12,500 /min	12,000 /min
Rated input power	1,550 W	1,550 W	1,600 W
Output power	840 W	810 W	900 W
Type of edges	Chamfer	Chamfer	Chamfer
Max. chamfer width 45°	14 mm	14 mm	21 mm
Max. chamfer height 15° / 30° / 45°	22.5 mm / 15 mm / 10 mm	22.5 mm / 15 mm / 10 mm	28 mm / 23 mm / 15 mm
Grading of cutting depth setting	0.1 mm	0.1 mm	0.1 mm
Curves smallest outer Ø	75 mm	75 mm	100 mm
Weight (without mains cable)	4.9 kg	5.1 kg	6.9 kg
Cable length	4 m	4 m	4 m

Scope of delivery

Order no.	601752 <sup>1) 2)</sup>	601755 <sup>1) 2)</sup>	601753 <sup>1) 2)</sup>
3 Carbide indexable inserts Universal	■	■	■
Stop roller	■	■	■
Screwdriver Torx 15	■	■	■
Screwdriver SW 4 with T-handle	■	■	■
Open-jawed spanner SW 10	■	■	■
Side handle	■	■	■
Metal carry case	■	■	■

<sup>1)</sup> also available in 120 V (North/Latin America)

<sup>2)</sup> also available in 110 V (UK)

Product advantages

- Metal bevelling tool for chamfer heights up to 10 mm for weld seam preparation
- Thumbwheel controlled Vario-Constamatic (VC)-Full wave electronics ideal for working on materials requiring customised speeds, and at speeds which remain almost constant under load
- Metal bevelling tool for chamfer heights up to 10 mm for weld seam preparation with maximum user safety by virtue of a dead-man switch and brake system
- Tacho Constamatic (TC) Full-wave Electronics: fast work progress by means of constant speed under load
- Patented, mechanical brake system stops the router bit within 2 seconds after switching off
- One-touch controller: Patented, tool-free setting of the cutting depth in 0.1 steps; stop points for short setting times, and protection against unintentional adjustment of the cutting depth when working
- Precise setting of the chamfer angle directly via the guide plates
- Universal milling head with three carbide indexable inserts for all chamfer angles from 0-90°
- Controlled working by virtue of large-scale guide plates
- Stop roller to guide along pipes for easy preparation of weld seams
- Front handle for safe and uniform guidance, adjustable without the need for tools
- Metabo Marathon-motor with patented dust protection for long service life
- Electronic overload protection, soft start and restart protection
- Protection of the user by virtue of lateral plates for conveying the chips



System components

Accessories → 214

01  
02  
03  
04  
05  
06  
07  
08  
09  
10  
11  
12  
13  
14  
15



Carbide indexable inserts for deburring and rounding

- For deburring of sheet metal with many contours
- For chamfering of pipes
- For chamfering and rounding of drilled and punched edges
- Suitable for KFM 9-3 RF, KFM 18 LTX 3 RF

	Order no.
 10 Carbide indexable inserts R2, radius 2	623561000
 10 Carbide indexable inserts R3, radius 3	623562000
 10 Carbide indexable inserts chamfer 45°	623560000

Carbide indexable inserts for weld seam preparation

- For weld seam preparation of flat material and pipes
- Suitable for KFM 15-10 F, KFM 16-15 F, KFMPB 15-10 F



	Order no.
 10 Carbide indexable inserts Universal For chamfering of production and in fine-grained steel, as well as stainless steel	623564000
 10 Carbide Indexable Inserts For chamfering stainless steel	623565000
 10 Carbide Indexable Inserts For chamfering aluminium and plastics	623559000

NEW

Fixing screws for indexable inserts

	Order no.
 <ul style="list-style-type: none"> <li>■ To fix the indexable inserts for the beveling tools</li> <li>■ The screws have a hexagon recess on the thread side so that the indexable inserts can also be exchanged with a damaged screw and the screws can be replaced.</li> <li>■ Suitable for KFM 15-10 F, KFM 16-15 F, KFMPB 15-10 F, KFM 9-3 RF, KFM 18 LTX 3 RF</li> </ul>	623566000

Accessories for Shears

	Order no.
 <b>Reversible blade</b> ■ Same blade for tappet and cutting bench For the curve shears Ku 6870	630201000
 <b>Reversible blade</b> ■ Same blade for tappet and cutting bench For the curve shears Ku 6872	631042000
 <b>Tappet blade</b> Suitable for Ku 6872 and Ku 6870	631041000

Accessories for Nibblers

	Order no.
 <b>Punch</b> For the nibbler Kn 6875 (as spare)	630202000
 <b>Die</b> For the nibbler Kn 6875 (as spare)	630203000



Technical data

Metal Chop Saw  
CS 23-355

Grinding wheels (Ø x bore)	355 x 25.4 mm
Torque	18 Nm
No-load speed	4,000 /min
Rated input power	2,300 W
Cutting capacity steel bars	65 mm
Cutting capacity pipes	125 mm
Cutting capacity steel sections	115 x 130 mm
Maximum opening of vice jaws	238 mm
Dimensions of the base plate	468 x 282 mm
Transport height	400 mm
Weight	16.9 kg
Cable length	2.7 m

Scope of delivery

Order no.	602335 <sup>1) 2)</sup>
Open-ended ring spanner	■
Inner support flange	■
Flange nut	■

<sup>1)</sup> also available in 120 V (North/Latin America)

<sup>2)</sup> also available in 110 V (UK)

Product advantages

- For single phase alternating current
- Powerful and fast cutting for profiles, pipes and rods made of steel, cast iron, aluminium and other non-ferrous metals.
- Motor and gear with ball bearing for high loads
- Spindle lock for easy disc change
- Quick clamping device with variable mitre conversion from -15° up to 45°
- Easy to transport due to built-in handle and locking device
- High safety thanks to swivelling cutting guard
- Storage for double-ended wrench at the machine table
- Safe working thanks to adjustable spark guide plate
- Adjustable cutting depth limiter

System components

Accessories → 216

Quality class A 30-R / A 36-S »Flexiamant Super« steel



- Good cutting output with good tool life in steel
- Tough version for powerful machines (machine load > 3 KW)
- A 36-S: with an inside gauze for quick cuts
- Maximum working speed 80 m/s

Quality class	Diameter x thickness x bore mm	Version	Maximum speed /min	Sales unit / packing unit	Order no.
A 30-R	350 x 3 x 25.4	—	4,365	1/10	616327000
A 36-S	350 x 3 x 25.4	—	4,365	1/10	616339000

Quality class A 24-M »Flexiamant Super« steel



- High cutting output with good tool life in steel
- Soft version for less powerful machines (machine load <3 KW)
- Maximum working speed 80 m/s

Quality class	Diameter x thickness x bore mm	Version	Maximum speed /min	Sales unit / packing unit	Order no.
A 24-M	350 x 3 x 25.4	—	4,365	1/10	616338000

Quality class A 36-R »Flexiamant Super« Inox



- Medium-hard special cutting disc for stainless steel
- High cutting output with good tool life
- Low in iron and sulphur <0.1%
- Maximum working speed 80 m/s
- Medium hard version for less powerful machines (machine load <3 KW)

Quality class	Diameter x thickness x bore mm	Version	Maximum speed /min	Sales unit / packing unit	Order no.
A 36-R	350 x 3 x 25.4	—	4,365	1/10	616343000



Technical data

	Bench Grinder DS 125	Bench Grinder DS 150
Grinding wheels (Ø x thickness x bore)	125 x 20 x 20 mm	150 x 20 x 20 mm
No-load speed	2,980 /min	2,980 /min
Rated input power	200 W	350 W
Output power	130 W	200 W
Breakdown torque	0.9 Nm	1.1 Nm
Weight	7.5 kg	9.5 kg
Cable length	2 m	2 m

Scope of delivery

Order no.	619125	619150 <sup>1)</sup>
Aluminium oxide grinding wheels 36 P and 60 N	■	■
Spark protection glasses	■	■
Work piece support	■	■
Hexagonal wrench	■	■

<sup>1)</sup> also available in 120 V (North/Latin America)

Product advantages

- Small and space-saving workshop machine
- Low-noise and low-vibration, maintenance-free induction motor
- Motor for single phase alternating current
- Protective guard bayonet lock for quick and simple wheel change
- Large spark protection guards for eye protection
- Vibration-dampening rubber feet for safe support

System components

Accessories → 220

01  
02  
03  
04  
05  
06  
07  
08  
09  
10  
11  
12  
13  
14  
15



Technical data	Bench Grinder DS 175	Combo Bench Grinder BS 175	Combo Dry-Wet Grinder TNS 175
Grinding wheels (Ø x thickness x bore)	175 x 25 x 32 mm	175 x 25 x 32 mm	175 x 25 x 32 mm
Wet grinding wheel (Ø x thickness x bore)	-	-	200 x 40 x 20 mm
No-load speed	2,980 /min	2,980 /min	2,980/132 /min
Rated input power	500 W	500 W	500 W
Output power	310 W	310 W	310 W
Breakdown torque	2.3 Nm	2.3 Nm	2.3 Nm
Length of belt grinding arm	-	285 mm	-
Sanding belt (width x length)	-	50 x 1,020 mm	-
Belt speed	-	18 m/s	-
Extraction nozzle, internal Ø	35 mm	35 mm	35 mm
Weight	14.9 kg	14.9 kg	15.2 kg
Cable length	2 m	2 m	2 m

Scope of delivery

Order no.	619175 <sup>1)</sup>	601750	611750
Regular aluminium oxide grinding wheels 36 P and 60 N	■		
Spark protection glasses	■	■	■
Work piece support	■	■	■
Hexagonal wrench	■	■	■
Regular aluminium oxide grinding wheel 60 N		■	■
Cloth Sanding Belt K 60		■	
Wet grinding wheel			■

<sup>1)</sup> also available in 120 V (North/Latin America)

Product advantages

- Large belt sanding arm which can be continuously tilted by 90° for processing wood and metal work pieces
- Varied application by means of combination of wet and dry grinding disc
- Corrosion-proof water bath container
- Sturdy machine for sophisticated sharpening, grinding and deburring tasks
- Low-noise and low-vibration, maintenance-free induction motor
- Motor for single phase alternating current
- Guards closed on the sides with extraction nozzle
- Protective guard bayonet lock for quick and simple wheel change
- Dust-protected emergency stop switch
- Restart protection: prevents unintentional start-up after power supply interruption
- Workpiece support adjustable without tools
- Large spark protection guards for eye protection
- Vibration-dampening rubber feet for safe support

System components

Accessories → 220



Technical data	Bench Grinder DS 200	Bench Grinder DSD 200	Bench Grinder DSD 250
Grinding wheels (Ø x thickness x bore)	200 x 25 x 32 mm	200 x 25 x 32 mm	250 x 40 x 51 mm
No-load speed	2,980 /min	2,980 /min	1,490 /min
Rated input power	600 W	750 W	650 W
Output power	420 W	550 W	490 W
Breakdown torque	2.6 Nm	7.2 Nm	10 Nm
Extraction nozzle, internal Ø	35 mm	35 mm	35 mm
Weight	16.6 kg	17.2 kg	33.8 kg
Cable length	2 m	2 m	2 m

Scope of delivery

Order no.	619200 <sup>1)</sup>	619201	619250 <sup>1)</sup>
Regular aluminium oxide grinding wheels 36 P and 60 N	■	■	■
Spark protection glasses	■	■	■
Work piece support	■	■	■
Hexagonal wrench	■	■	■

<sup>1)</sup> also available in 120 V (North/Latin America)

Product advantages

- Motor for single phase alternating current
- Powerful three-phase motor with high torque
- Powerful three-phase motor with high torque
- Particularly powerful machine for high requirements
- Low-noise and low-vibration, maintenance-free induction motor
- Robust die-cast aluminium guards
- Protective guard bayonet lock for quick and simple wheel change
- Dust-protected emergency stop switch
- Restart protection: prevents unintentional start-up after power supply interruption
- Workpiece support adjustable without tools
- Large spark protection guards for eye protection
- Vibration-dampening rubber feet for safe support

System components

Accessories → 220

## Grinding Wheels

### Grinding wheels, aluminium oxide

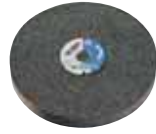

- For sanding/grinding tool steel
- Fine grit (60N): suitable for fine grinding of hardened and unhardened steels, for example spiral drills, screwdrivers, chisels, turning chisels, splitting tools, bevelled-edge chisels, carving knives
- Coarse grit (36P): suitable for pre-grinding of hardened and unhardened steels, for example chisels, splitting tools

Diameter x thickness x bore mm	Grit and hardness	Suitable for	Order no.
120 x 20 x 20	36 P	DS 125, Ds W 3150	629088000
120 x 20 x 20	60 N	DS 125, Ds W 3150	629089000
120 x 20 x 12	60 N	DS 125 W, Ds W 3150	629090000
150 x 20 x 20	36 P	DS 150, Ds W 3150	630632000
150 x 20 x 20	60 N	DS 150, Ds W 3150	630633000
150 x 20 x 32	36 P	Ds 7202	630777000
150 x 20 x 32	60 N	Ds 7202, Ds 7203	630778000
175 x 25 x 20	36 P	DS 175 W / DS 175 D	629091000
175 x 25 x 20	60 N	DS 175 W / DS 175 D	629092000
175 x 25 x 32	36 P	DS 175, BS 175, TNS 175, Ds W 5175 / Ds D 6175	630657000
175 x 25 x 32	60 N	DS 175, BS 175, TNS 175, Ds W 5175 / Ds D 6175	630656000
200 x 25 x 20	36 P	DS 200/25 W / DS 200/25 D	629093000
200 x 25 x 20	60 N	DS 200/25 W / DS 200/25 D	629094000
200 x 25 x 32	36 P	DS 200, DSD 200, Ds 7211, Ds W 9200 / Ds D 9201	630784000
200 x 25 x 32	60 N	DS 200, DSD 200, Ds 7211, Ds W 9200 / Ds D 9201	630785000
200 x 32 x 32	36 P	Ds W 9200 / Ds D 9201	630634000
200 x 32 x 32	60 N	Ds W 9200 / Ds D 9201	630635000
250 x 32 x 32	24 Q	Ds 7226	630788000
250 x 32 x 32	60 N	Ds 7226	630789000
250 x 40 x 51	36 P	DSD 250, Ds D 9250	630636000
250 x 40 x 51	60 N	DSD 250, Ds D 9250	630637000

### Pink aluminium oxide grinding wheels



- For sanding/grinding HSS tools

Diameter x thickness x bore mm	Grit and hardness	Suitable for	Order no.
150 x 20 x 20	80 J	Ds W 3150	630638000
150 x 50 x 13	80 I	Ds 7203	630779000

### Silicone carbide grinding wheels



- Suitable for fine ground finish on hard metals and carbide-coated tools, grey cast iron, copper, aluminium, glass, ceramic

Diameter x thickness x bore mm	Grit and hardness	Suitable for	Order no.
120 x 20 x 20	80 J	DS 125	629102000
150 x 20 x 20	80 J	DS 150, Ds W 3150	629103000
175 x 25 x 20	80 J	DS 175 W / DS 175 D, TNS 175	629095000
175 x 25 x 32	80 J	DS 175, BS 175, TNS 175	629104000
200 x 25 x 20	80 J	DS 200/25 W / DS 200/25 D, TNS 175	629096000
200 x 25 x 32	80 J	DS 200, DSD 200, Ds W 9200 / Ds D 9201	629105000
250 x 40 x 51	80 J	DSD 250, Ds D 9250	629106000

### Wet grinding wheels



- Suitable for fine grinding of unhardened steels, for example knives, bevelled-edge chisels, turning chisels, splitting tools, shears.

Diameter x thickness x bore mm	Grit and hardness	Suitable for	Order no.
150 x 30 x 20	220 K	TNS 150 W	629097000
200 x 40 x 20	220 K	TNS 175	629098000

## Sanding Belts



- High-quality sanding paper (aluminium oxide) with dense distribution, high removal of material and long durability. Universal use: For grinding and deburring metals, non-alloyed and low-alloyed steels, cast iron, aluminium alloys, brass, bronze, hard metal coatings, rubber, plastics etc.
- Recommended circumferential speed: 25-35 m/s

Dimensions mm	Grit	Sales unit	Order no.
50 x 650	P 60	3	629060000*
50 x 650	P 100	3	629061000*
50 x 650	P 150	3	629062000*
50 x 1,020	P 60	3	629063000*
50 x 1,020	P 80	3	629064000*
50 x 1,020	P 100	3	629065000*
50 x 1,020	P 120	3	629066000*
50 x 1,020	P 180	3	629067000*
50 x 1,020	P 240	3	629068000*
50 x 1,020	P 400	3	629069000*

## Further Accessories for Bench Grinders



- Dressing stick**  
Dressing stick made of silicone carbide. For dressing grinding wheels; blunt grinding abrasives are removed.



- Stands**  
Suitable for all Metabo bench grinders (from YOM 2005). With pull out container for cooling water or handy tool storage. A double vertical slit for storage of grinding wheels, tools etc. Height 835 mm, dimension of plate: 200 x 280 mm; Ø-Base plate: 340 mm

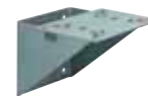

- Wall panel**  
Suitable for all Metabo bench grinders up to disc -Ø 200 mm (built after 2005), except BS 175, DS 250 D. Dimensions: 280 mm x 90 mm x 204 mm

\* Self-service packaging

# M+ System: Machine and accessories perfectly synchronised for maximum performance.

Even during the development phase at Metabo, machines and accessories are optimally adjusted and tested to complement one another. Your added benefit: Maximum performance for screwdriving, drilling, chiselling or stirring thanks to Metabo + System effect.



Machine



Consumables



System accessories









**Drilling**  
**Chiselling**  
**Screwdriving**  
**Stirring**



Which drill for which application?

																	
Comparative technical values	BE 6	BE 10	BE 500/6	BE 500/10	BE 600/13-2	BE 650		BE 75-16	BE 75 Quick*	BE 850-2	BEV 1300-2	BDE 1100	B 32/3	WBE 700	MAG 32	MAG 50	B 32/3 + M 100**
Rated input power	450 Watt	450 Watt	500 Watt	500 Watt	600 Watt	650 Watt		750 Watt	750 Watt	850 Watt	1,300 Watt	1,100 Watt	1,800 Watt	700 Watt	1,000 Watt	1,200 Watt	1,800 Watt
Drill Ø in steel	6 mm	10 mm	6 mm	10 mm	13 / 8 mm	13 mm		16 mm	16 mm	13 / 8 mm	16 / 10 mm	16 / 10 mm	32 mm	10 mm	32 mm	50 mm	100 mm
Drill Ø in soft wood	12 mm	20 mm	20 mm	30 mm	37 / 27 mm	30 mm		50 mm	50 mm	40 / 25 mm	40 / 25 mm	40 / 25 mm	70 mm	25 mm			
No-load speed	0-4,000 /min	0-2,400 /min	0-4,500 /min	0-1,600 /min	0-750 / 0-2,500 /min	0-2,800 /min		0-660 /min	0-660 /min	0-1,100/ 0-3,100 /min	0-1,100/ 0-3,100 /min	0-640 / 0-1,200 /min	0-170 / 0-320 / 0-470 /min	850-2,600 /min	700 /min	100-250 / 200-450 /min	0-170 / 0-320 / 0-470 /min
Chuck capacity	0-10 mm	0-10 mm	0-10 mm	1-13 mm	1-13 mm	1.5-13 mm		1.5-13 mm	1.5-13 mm	1.5-13 mm	1.5-13 mm	3-16 mm	-	1-10 mm	depending on drill chuck	depending on drill chuck	depending on drill chuck
Weight (without mains cable)	1.3 kg	1.3 kg	1.5 kg	1.8 kg	1.9 kg	1.8 kg		2.6 kg	2.6 kg	2.6 kg	2.7 kg	4.3 kg	7.8 kg	2.0 kg	11.9 kg	12.7 kg	29.5 kg
Bit retainer	1/2" - 20 UNF	1/2" - 20 UNF	1/2" - 20 UNF	1/2" - 20 UNF	1/2" - 20 UNF	1/2" - 20 UNF		1/2" - 20 UNF	-	1/2" - 20 UNF	1/2" - 20 UNF	5/8" - 16 UN	MK 3	1/2" - 20 UNF	Weldon	MK 2 + Weldon	MK 3
Maximum torque soft	7 Nm	10 Nm	8 Nm	16 Nm	31 / 9 Nm	9 Nm		75 Nm	75 Nm	36 / 14 Nm	44 / 16 Nm	55 / 22 Nm	190 / 120 / 90 Nm	8 Nm			

Application																		
Small drill Ø wood	■	■■■	■■■	■■■	■■■	■■■		■	■	■■■	■■■	■		■				
Large drill Ø wood				■	■			■■■	■■■	■	■	■	■■■					
Small drill Ø metal	■■■	■	■■■	■■■	■■■	■■■		■	■	■■■	■■■	■		■	■	■	■	■
Large drill Ø metal					■			■	■	■	■	■	■■■		■■■	■■■	■■■	■■■
Light screwing applications		■		■	■■■	■		■■■	■■■	■	■	■	■					
Heavy screwing applications								■	■	■	■	■	■■■					

Equipment																		
 Metabo S-automatic safety clutch								●	●	●	●	●	●					●
 Vario-Tacho-Constamatic (VTC)											●						●	
 Vario-Constamatic (VC)														●				
 Overload protection											●							
 Restart protection											●				●	●		
 Metabo Marathon-motor										●	●				●	●		
 Metabo »Quick« tool quick change																		

\* also available with torque setting adapter PowerX3: triples the power of the machine for extreme applications  
 \*\* combination of drill B 32/3 and electromagnetic drill stand M 100, can be ordered only individually



Technical data	Drill BE 6	Drill BE 10	Drill BE 650
Rated input power	450 W	450 W	650 W
Output power	240 W	240 W	320 W
Drill Ø steel	6 mm	10 mm	13 mm
Drill-Ø soft wood	12 mm	20 mm	30 mm
No-load speed	0 - 4,000 /min	0 - 2,400 /min	0 - 2,800 /min
Revolutions at rated load	2,200 /min	1,500 /min	1,500 /min
Gears	1	1	1
Maximum torque	7 Nm	10 Nm	9 Nm
Collar diameter	-	-	43 mm
Chuck capacity	1 - 10 mm	1 - 10 mm	1.5 - 13 mm
Drill spindle with hexagonal recess	-	-	1/4" (6.35 mm)
Drill spindle thread	1/2" - 20 UNF	1/2" - 20 UNF	1/2" - 20 UNF
Weight (without mains cable)	1.3 kg	1.3 kg	1.8 kg
Cable length	2.5 m	2.5 m	2.5 m

#### Scope of delivery

Order no.	600132	600133	600360
Geared chucks	■	■	■
Chuck keys	■	■	■

#### Product advantages

- Small, handy bench machine
- Small, handy bench machine
- Thumbwheel for speed preselection
- Spindle with hexagonal recess for screwdriver bits for working without chuck
- Variospeed (V) Electronics for working at customised speeds to suit various application materials
- Forward and reverse rotation
- Handle with non-slip soft-grip surface

#### System components

Accessories → 245



Technical data	Drill BE 500/6	Drill BE 500/10	Drill BE 600/13-2
Rated input power	500 W	500 W	600 W
Output power	250 W	250 W	290 W
Drill Ø steel	6 mm	10 mm	13 mm/8 mm
Drill-Ø soft wood	20 mm	30 mm	37 mm/27 mm
No-load speed	0 - 4,500 /min	0 - 1,600 /min	0 - 750 / 0 - 2,500 /min
Revolutions at rated load	2,600 /min	1,000 /min	450/1,500 /min
Gears	1	1	2
Maximum torque	8 Nm	16 Nm	31 Nm/9 Nm
Collar diameter	43 mm	43 mm	43 mm
Chuck capacity	1 - 10 mm	1 - 13 mm	1 - 13 mm
Drill spindle with hexagonal recess	1/4" (6.35 mm)	1/4" (6.35 mm)	1/4" (6.35 mm)
Drill spindle thread	1/2" - 20 UNF	1/2" - 20 UNF	1/2" - 20 UNF
Weight (without mains cable)	1.5 kg	1.8 kg	1.9 kg
Cable length	4 m	4 m	4 m

#### Scope of delivery

Order no.	600343	600353	600383
Futuro Top keyless chuck	■	■	■
Side handle	■	■	■
Open-jawed spanner	■	■	■

#### Product advantages

- Optimal speed range for precise drilling into steel up to Ø 6 mm
- Optimal speed range for precise drilling into steel up to Ø 10 mm
- Two-speed gearbox with wide speed range for versatile drilling work up to Ø 13 mm in steel
- Thumbwheel for speed preselection
- Handy drill especially for demanding metal processing
- Robust die cast aluminium gear housing for optimum heat dissipation and long service life
- Particularly compact design with small dimension across corners
- Variospeed (V) Electronics for working at customised speeds to suit various application materials
- Forward and reverse rotation
- Keyless chuck and spindle stop for convenient one-handed tool change
- Futuro top keyless chuck: automatic retightening when drilling for precise drilling results
- Handle with non-slip soft-grip surface

#### System components

Accessories → 245



Technical data	Drill BE 75-16	Drill BE 75 Quick	Drill BE 75-X3 Quick
Rated input power	750 W	750 W	750 W
Output power	470 W	470 W	470 W
Drill Ø steel	16 mm	16 mm	16 mm
Drill-Ø soft wood	50 mm	50 mm	50 mm
No-load speed	0 - 660 /min	0 - 660 /min	0 - 660 /min
Revolutions at rated load	350 /min	350 /min	350 /min
Gears	1	1	1
Maximum torque	75 Nm	75 Nm	75 Nm
Collar diameter	43 mm	43 mm	43 mm
Chuck capacity	1.5 - 13 mm	1.5 - 13 mm	1.5 - 13 mm
Drill spindle with hexagonal recess	1/4" (6.35 mm)	1/4" (6.35 mm)	1/4" (6.35 mm)
Drill spindle thread	1/2" - 20 UNF	-	-
Weight (without mains cable)	2.6 kg	2.6 kg	2.6 kg
Cable length	4 m	4 m	4 m

Scope of delivery

Order no.	600580 <sup>1) 2)</sup>	600585700	600585800
PowerX 3 torque setting adapter with long side handle			■
Geared chucks	■		
Geared quick change drill chuck		■	■
Quick-change bit holder		■	■
Quick-change angle adapter		■	■
Chuck keys	■	■	■
Long side handle	■	■	■
MetaLoc case		■	■

Equipment variants can be found in the Metabo price list and on the internet

<sup>1)</sup> also available in 120 V (North/Latin America)

<sup>2)</sup> also available in 110 V (UK)

Product advantages

- Suitable for powerful drilling of larger diameters and for stirring thick, liquid-like materials
- The torque setting adapter PowerX3 triples the power of the tool for extreme applications
- Suitable for drilling with large diameters and for heavy screw jointing in wood without pre-drilling
- Metabo Quick System: quick change of bit retainer and bits, for flexible working
- Forward and reverse rotation
- Robust die cast aluminium gear housing for optimum heat dissipation and long service life
- Rotating carbon brush bridge for maximum performance even in anti-clockwise operation, e.g. for the removal of stubborn screws
- Variospeed (V) Electronics for working at customised speeds to suit various application materials
- Metabo S-automatic safety clutch: mechanical decoupling of the drive for safe working should the drill stop unexpectedly
- Spindle with hexagonal recess for screwdriver bits for working without chuck

System components

Accessories → 245, 250

Quick-System → 18

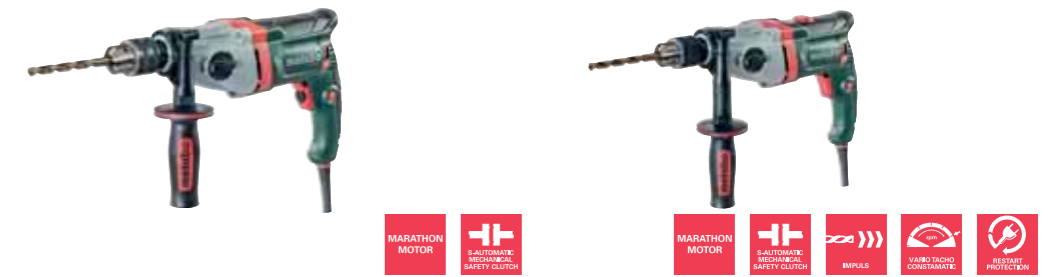

Technical data	Drill BE 850-2	Drill BEV 1300-2
Rated input power	850 W	1,300 W
Output power	490 W	730 W
Drill Ø steel	13 mm/8 mm	16 mm/10 mm
Drill-Ø soft wood	40 mm/25 mm	40 mm/25 mm
No-load speed	0 - 1,100 / 0 - 3,100 /min	0 - 1,100 / 0 - 3,100 /min
Revolutions at rated load	640/1,800 /min	1,100/3,100 /min
Gears	2	2
Maximum torque	36 Nm/14 Nm	44 Nm/16 Nm
Collar diameter	43 mm	43 mm
Chuck capacity	1.5 - 13 mm	1.5 - 13 mm
Drill spindle with hexagonal recess	1/4" (6.35 mm)	1/4" (6.35 mm)
Drill spindle thread	1/2" - 20 UNF	1/2" - 20 UNF
Weight (without mains cable)	2.6 kg	2.7 kg
Cable length	4 m	4 m

Scope of delivery

Order no.	600573 <sup>1)</sup>	600574 <sup>1)</sup>
Geared chucks	■	■
Chuck keys	■	■
Side handle	■	■

<sup>1)</sup> also available in 120 V (North/Latin America)

Product advantages

- Variospeed (V) Electronics for working at customised speeds to suit various application materials
- Selectable "impuls" mode for removal of stubborn screws and for spot-drilling on smooth surfaces
- Vario-Tacho-Constamatic (VTC)-Full Wave Electronics for work with materials requiring customised speeds, which remain constant under load
- Overload protection: protects the motor from overheating
- Restart protection: prevents unintentional start-up after power supply interruption
- Wear Indication for Carbon Brush
- Robust die cast aluminium gear housing for optimum heat dissipation and long service life
- Rotating carbon brush bridge for maximum performance even in anti-clockwise operation, e.g. for the removal of stubborn screws
- Thumbwheel for speed preselection
- Two-speed gearbox
- Metabo Marathon-motor with patented dust protection for long service life
- Metabo S-automatic safety clutch: mechanical decoupling of the drive for safe working should the drill stop unexpectedly
- Forward and reverse rotation
- Spindle with hexagonal recess for screwdriver bits for working without chuck
- Handle with non-slip soft-grip surface
- Cable-protecting ball joint for optimal freedom of motion when working

System components

Accessories → 245



Technical data	Drill BDE 1100
Rated input power	1,100 W
Output power	620 W
Drill diameter in	
- Steel	16 mm/10 mm
- Soft wood	40 mm/25 mm
No-load speed	0 - 640 / 0 - 1,200 /min
Revolutions at rated load	430/800 /min
Maximum torque - soft	55 Nm/22 Nm
Collar diameter	43 mm
Chuck capacity	3 - 16 mm
Drill spindle thread	5/8 " - 16 UN
Weight (without mains cable)	4.3 kg
Cable length	3 m

#### Scope of delivery

Order no.	600806 <sup>2)</sup>
Geared chucks	■
Chuck keys	■
Long side handle	■
Drilling depth guide	■

<sup>2)</sup> also available in 110 V (UK)

#### Product advantages

- Robust die cast aluminium gear housing for optimum heat dissipation and long service life
- Variospeed (V) Electronics for working at customised speeds to suit various application materials
- Two-speed gearbox
- Metabo S-automatic safety clutch: mechanical decoupling of the drive for safe working should the drill stop unexpectedly
- Forward and reverse rotation
- Suitable for powerful drilling of larger diameters and for stirring thick, liquid-like materials
- Comfortable operation and safety through auxiliary handle

#### System components

Accessories → 245



Technical data	Angle Drill WBE 700
Rated input power	700 W
Output power	305 W
Drill diameter in	
- Steel	10 mm
- Soft wood	25 mm
No-load speed	850 - 2,600 /min
Revolutions at rated load	2,300 /min
Maximum torque - soft	8 Nm
Chuck capacity	1 - 10 mm
Drill spindle thread	1/2 " - 20 UNF
Weight (without mains cable)	2 kg
Cable length	4 m

#### Scope of delivery

Order no.	600512
Geared chucks	■
Chuck keys	■
Side handle	■

#### Product advantages

- Powerful angle drill for drilling in difficult to access areas
- Robust die cast aluminium gear housing for optimum heat dissipation and long service life
- Vario Constamatic (VC) Electronics for work with materials requiring customised speeds, which remain almost constant under load
- Thumbwheel for speed preselection



Technical data	Drill B 32/3
Rated input power	1,800 W
Output power	1,200 W
Drill Ø steel	32 mm
Drill-Ø soft wood	70 mm
No-load speed	0 - 170 / 0 - 320 / 0 - 470 /min
Revolutions at rated load	110/190/280 /min
Gears	3
Maximum torque	190 Nm/120 Nm/90 Nm
Collar diameter	65 mm
Drill spindle with inside taper	MK 3
Weight (without mains cable)	7.8 kg
Cable length	5 m

#### Scope of delivery

Order no.	600323
Drift key	■
Long side handle	■





#### Product advantages

- Powerful three-speed drill with extra high torque
- Robust mechanical gearbox with oil bath lubrication
- Robust die cast aluminium gear housing for optimum heat dissipation and long service life
- Variospeed (V) Electronics for working at customised speeds to suit various application materials
- Safety clutch: mechanical decoupling of the drive for safe working should the drill stop unexpectedly
- For easy drilling of larger diameters and driving in of very long screws

#### System components

Accessories → 249, 273

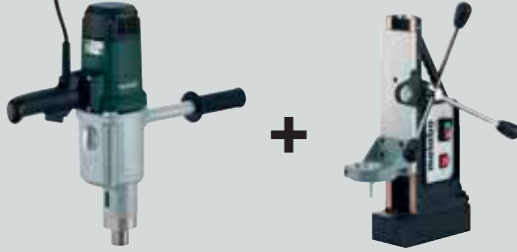
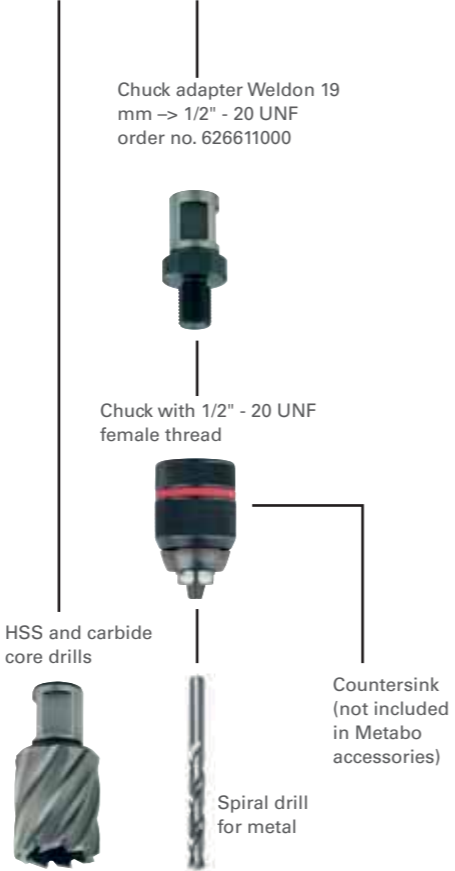
# Which magnetic core drill for which application?

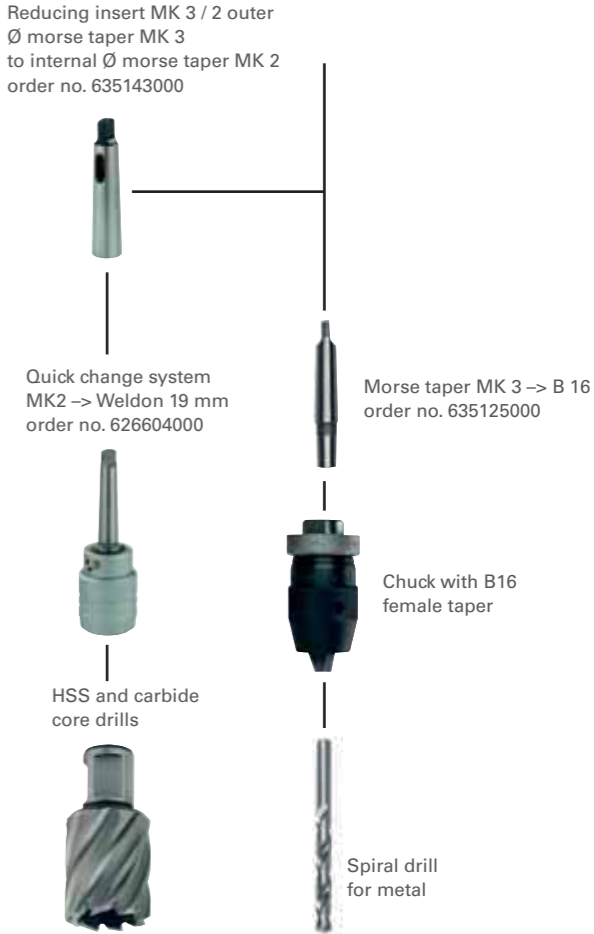
	MAG 32	MAG 50	B 32/3 + M100	
<b>Bit retainer</b>				
Weldon direct chuck 19 mm (3/4") with automatic internal cooling	•	•		
MK 2 chuck		•		
MK 3 chuck			•	
<b>Application</b>				
Drilling with core drills	■■■	■■■	■■■	
Drilling with spiral drills	■■■	■■■	■■■	
Working with countersinks	■	■■■	■	
Threaded drill	-	■■■	-	
	 <p>Chuck adapter Weldon 19 mm -&gt; 1/2" - 20 UNF order no. 626611000</p> <p>Chuck with 1/2" - 20 UNF female thread</p> <p>HSS and carbide core drills</p> <p>Countersink (not included in Metabo accessories)</p> <p>Spiral drill for metal</p>		 <p>Morse taper MK 2 -&gt; B 16 order no. 635115000</p> <p>Chuck with B16 female taper</p> <p>HSS and carbide core drills</p> <p>Spiral drill for metal</p>	 <p>Reducing insert MK 3 / 2 outer Ø morse taper MK 3 to internal Ø morse taper MK 2 order no. 635143000</p> <p>Quick change system MK2 -&gt; Weldon 19 mm order no. 626604000</p> <p>Morse taper MK 3 -&gt; B 16 order no. 635125000</p> <p>Chuck with B16 female taper</p> <p>HSS and carbide core drills</p> <p>Spiral drill for metal</p>

Application: ■ suitable ■■ very suitable ■■■ optimum Equipment: ● present ○ optional

01  
02  
03  
04  
05  
06  
07  
08  
09  
10  
11  
12  
13  
14  
15



Technical data	Magnetic Core Drill MAG 32	Magnetic Core Drill MAG 50
Rated input power	1,000 W	1,200 W
Output power	520 W	620 W
Max. drill-Ø with core drill	32 mm	50 mm
Max. drill-Ø with spiral drill	13 mm	20 mm
Maximum drilling depth	50 mm	50 mm
Thread cutting	-	M 16
No-load speeds	700 /min	100 - 250 / 200 - 450 /min
Revolutions at rated load	450 /min	250/450 /min
Bit retainer	Weldon shaft 19 mm (3/4")	Morse taper MK 2, Weldon shaft 19 mm (3/4")
Weight	11.9 kg	12.7 kg
Cable length	5 m	5 m
Torque	50 Nm	90 Nm/50 Nm
Max. depth of feed	160 mm	160 mm
Max. magnetic holding force	12,250 N	12,250 N
Dimensions of the magnet base	90 x 189 mm	90 x 190 mm
Height carriage lowest position	343 mm	457 mm
Height carriage topmost position	490 mm	610 mm

Scope of delivery

Order no.	600635 <sup>1)</sup>	600636 <sup>1)</sup>
Industrial holder for Weldon shank 19 mm		■
Ejector pins 75 and 100 mm		■
Ejector pin 75 mm	■	
MK 2 drift key		■
Safety strap	■	■
Allen key	■	■
Swarf protection guard	■	■
Transport case	■	■

<sup>1)</sup> also available in 120 V (North/Latin America)

Product advantages

- Vario-Tacho-Constamatic (VTC)-Full Wave Electronics for work with materials requiring customised speeds, which remain constant under load
- Clockwise/anti-clockwise rotation with thread cutter
- Durable two-speed gearbox with oil bath lubrication for ideal speeds
- Overload protection
- Magnetic base with high holding power permits working on vertical surfaces and overhead
- Robust Metabo Marathon-motor with internal wiring for long service life
- Integrated coolant container for easy to dose internal cooling of the core drill
- Bright LED light for easy alignment in poor light conditions
- Swarf protection guard can be fixed without tools and protects the user from metal shavings and tool contact
- Protective circuit starts motor only if the magnet is activated
- Restart protection: prevents unintentional start-up after power supply interruption
- Lockable slide for comfortable tool change

System components

Accessories → 235

HSS core drills, short



- With Weldon shank 19 mm (3/4")
- Insert only with suitable centering pin
- Suitable for steel, cast steel, coloured and light metals

Diameter mm	Overall length mm	Working length mm	Order no.
12	64	30	626500000*
13	64	30	626501000*
14	64	30	626502000*
15	64	30	626503000*
16	64	30	626504000*
17	64	30	626505000*
18	64	30	626506000*
19	64	30	626507000*
20	64	30	626508000*
21	64	30	626509000*
22	64	30	626510000*
23	64	30	626511000*
24	64	30	626512000*
25	64	30	626513000*
26	64	30	626514000*
27	64	30	626515000*
28	64	30	626516000*
29	64	30	626517000*
30	64	30	626518000*
31	64	30	626519000*
32	64	30	626520000*

HSS core drills, long



- With Weldon shank 19 mm (3/4")
- Insert only with suitable centering pin
- Suitable for steel, cast steel, coloured and light metals

Diameter mm	Overall length mm	Working length mm	Order no.
12	90	55	626521000*
13	90	55	626522000*
14	90	55	626523000*
15	90	55	626524000*
16	90	55	626525000*
17	90	55	626526000*
18	90	55	626527000*
19	90	55	626528000*
20	90	55	626529000*
21	90	55	626530000*
22	90	55	626531000*
23	90	55	626532000*
24	90	55	626533000*
25	90	55	626534000*
26	90	55	626535000*
27	90	55	626536000*
28	90	55	626537000*
29	90	55	626538000*
30	90	55	626539000*
31	90	55	626540000*
32	90	55	626541000*

\*Self-service packaging

Carbide core drills



- Core drill Ø 14 - 60 mm with Weldon shank 19 mm (3/4")
- Core drill as of Ø 70 mm with Weldon shank 32 mm (1 1/4")
- Insert only with suitable centering pin
- Also suitable for higher alloyed steels

Diameter mm	Overall length mm	Working length mm	Order no.
14	90	55	626571000*
15	90	55	626572000*
16	90	55	626573000*
17	90	55	626574000*
18	90	55	626575000*
19	90	55	626576000*
20	90	55	626577000*
21	90	55	626578000*
22	90	55	626579000*
23	90	55	626580000*
24	90	55	626581000*
25	90	55	626582000*
26	90	55	626583000*
27	90	55	626584000*
28	90	55	626585000*
29	90	55	626586000*
30	90	55	626587000*
31	90	55	626588000*
32	90	55	626589000*
33	90	55	626590000*
34	90	55	626591000*
35	90	55	626592000*
36	90	55	626593000*
37	90	55	626594000*
38	90	55	626595000*
39	90	55	626596000*
40	90	55	626597000*
45	90	55	626598000*
50	90	55	626599000*
60	90	55	626614000
70	90	55	626616000
80	90	55	626618000
90	90	55	626620000
100	90	55	626622000

Core drill bit assortments



**HSS core drill set 3 pieces**  
 ■ Suitable for steel, cast steel, coloured and light metals  
 Core bits Ø 14/18/22 mm  
 30 mm working length, Weldon shank 19 mm (3/4")  
 including centering pin

Order no.  
626623000



**HSS core drill set 6 pieces**  
 ■ Suitable for steel, cast steel, coloured and light metals  
 Core drill bits Ø 14/16/18/20/22/26 mm  
 30 mm working length, Weldon shank 19 mm (3/4")  
 including centering pin

Order no.  
626624000

Centering pins



**Centering pin for HSS short**  
 For HSS core drill bits with a 30 mm working length  
 Diameter: 6.35 mm  
 Overall length: 75 mm

Order no.  
626608000\*



**Centering pin for HSS long and carbide**  
 For HSS core drill bits with a 55 mm working length  
 For carbide core drill bits up to Ø 60 mm  
 Diameter: 6.35 mm  
 Overall length: 100 mm

Order no.  
626609000\*



**Centering pin for carbide**  
 For carbide core drill bits Ø 70 - 100 mm  
 Diameter: 8 mm  
 Overall length: 120 mm

Order no.  
626610000\*

Industrial holders



**Industrial holder MK2**  
 With automatic interior cooling  
 For the MAG 50  
 For the B 32/3 only in conjunction with the reducing sleeve MK 3 / MK 2 (635143000)  
 Drill spindle holder: Morse arbor MK 2  
 Tool holder: Weldon shaft 19 mm (3/4")

Order no.  
626602000



**Industrial holder MK3**  
 With manual interior cooling  
 For the B 32/3 and carbide core drill Ø 70-100 mm  
 Drill spindle holder: Morse arbor MK 3  
 Tool holder: Weldon shaft 32 mm (1 1/4")

Order no.  
626603000



**Quick Change System**  
 Simple and fast change of core drill without additional tools  
 With automatic interior cooling  
 For the MAG 50  
 For the B 32/3 only in conjunction with the reducing sleeve MK 3 / MK 2 (635143000)  
 Drill spindle holder: Morse arbor MK 2  
 Tool holder: Weldon shaft 19 mm (3/4")

Order no.  
626604000

Adapters



**Adapter for Weldon to Fine Quick IN**  
 Incl. centering pin (overall length: 120 mm; Ø 6.35 mm)  
 Drill spindle holder: Weldon shaft 19 mm (3/4")  
 Tool holder: Fine QuickIN

Order no.  
626600000



**Chuck adapter**  
 Weldon 19 mm (3/4") to 1/2" - 20 UNF  
 Drill spindle holder: Weldon shaft 19 mm (3/4")  
 Tool holder: 1/2" - 20 UNF

Order no.  
626611000\*

Cooling lubricants



**Universal cutting paste**  
 ■ Increase of durability with tools, for example, core drills, metal drill bits, BiM hole saws, router bits or saw blades  
 ■ Greater cutting speeds thanks to optimum cooling properties  
 ■ Core drilling: use of cutting paste with overhead work, in horizontal position of MAG or when using the B 32/3 without automatic interior cooling

Order no.  
626605000\*



**Universal cutting spray**  
 ■ Extended service life for tools like e.g. core drill  
 ■ Greater cutting speeds thanks to optimum cooling properties  
 ■ Core drilling: use of cutting spray with overhead work, in horizontal position of MAG or when using the B 32/3 without automatic interior cooling

Order no.  
626606000

\*Self-service packaging

# Impact drills from Metabo: Quality and experience for over 60 years.

Since the large-scale production of the first impact drill, which, in 1957, cost a month's wage, we have continuously been setting new standards when it comes to drilling and impact drilling. Our high quality standards guarantee optimal work results and precisely drilled holes. Whether in wood, metal, masonry or concrete - each material has different demands for drill speed, torque, speed and accessories. We offer you the right impact drill including accessories for any challenge.

**Robust die-cast aluminium gear housing** for optimal heat dissipation and long service life



**Metabo S-automatic safety clutch** mechanical decoupling of the drive when the tool stops unexpectedly for safe working

**Keyless chuck and spindle-stop gear** for comfortable, single-handed tool change



**MARATHON MOTOR**

**Metabo Marathon-motor** with dust protection for long service life

**Vario Tacho Constamatic (VTC) Full-wave Electronics** for working at customised speeds, which remain constant under load, to suit various application materials



**Selectable »Impuls« mode** for the removal of tight-fitting screws and spot-drilling on smooth surfaces



**Overload protection and restart protection** to protect the user and machine

SBEV 1300-2 S



When impact drilling in masonry, the VTC constant electronics, the high impact rate and consistent power delivery ensures excellent drilling progress even under the highest load



The high torque and constant speeds develop plenty of power and endurance when drilling into wood, even for large diameters.



The highly accurate keyless chuck and adjustable speeds to suit any material guarantee best work results even in metal.

## Which impact drill for which application?

	Impact drilling in masonry max. Ø	Drilling in metal / wood max. Ø	Output	Safety clutch	Marathon motor	Constant electronics	Restart protection	Overload protection	Impuls function	Speed selection	Spindle stop
--	-----------------------------------	---------------------------------	--------	---------------	----------------	----------------------	--------------------	---------------------	-----------------	-----------------	--------------

### 1-speed Impact Drills

	SB 650 / SBE 650 / SBE 650 Impuls	16 mm	13/30 mm	650 W						- / - / •	- / • / •
--	-----------------------------------	-------	----------	-------	--	--	--	--	--	-----------	-----------

### 2-speed Impact Drills

	SB 760 / SBE 760	18 mm	13/40 mm	760 W	•						- / •
	SBE 780-2	20 mm	13/40 mm	780 W	•	•					•
	SB 850-2	20 mm	13/40 mm	850 W	•	•					
	SBE 850-2 / SBE 850-2 S	20 mm	13/40 mm	850 W	•	•					• - / •
	SBEV 1000-2	22 mm	16/40 mm	1,010 W	•	•	•	•			•
	SBEV 1100-2 S	24 mm	16/40 mm	1,100 W	•	•	•	•	•	•	•
	SBEV 1300-2 / SBEV 1300-2 S	24 mm	16/40 mm	1,300 W	•	•	•	•	•	•	- / •

■ ideal range  
■ possible range

For even larger diameters when drilling in hard materials we recommend to use a Metabo drill, combination or multi hammer.

Equipment: • present





Technical data	Impact Drill SB 650	Impact Drill SBE 650	Impact Drill SBE 650 Impuls
Rated input power	650 W	650 W	650 W
Output power	320 W	320 W	320 W
Maximum torque	9 Nm	9 Nm	9 Nm
Drill-Ø masonry	16 mm	16 mm	16 mm
Drill-Ø concrete	14 mm	14 mm	14 mm
Drill Ø steel	13 mm	13 mm	13 mm
Drill-Ø soft wood	30 mm	30 mm	30 mm
No-load speed	2,800 /min	0 - 2,800 /min	0 - 2,800 /min
Revolutions at rated load	1,500 /min	1,500 /min	1,500 /min
Maximum impact rate	44,800 /min	44,800 /min	44,800 /min
Gears	1	1	1
Chuck capacity	1.5 - 13 mm	1.5 - 13 mm	1.5 - 13 mm
Collar diameter	43 mm	43 mm	43 mm
Drill spindle with hexagonal recess	1/4" (6.35 mm)	1/4" (6.35 mm)	1/4" (6.35 mm)
Drill spindle thread	1/2 " - 20 UNF	1/2 " - 20 UNF	1/2 " - 20 UNF
Weight (without mains cable)	1.8 kg	1.8 kg	1.8 kg
Cable length	2.5 m	2.5 m	2.5 m

Scope of delivery

Order no.	600670	600671 <sup>1) 2)</sup>	600672
Geared chucks	■		
Chuck keys	■		
Futuro Plus keyless chuck		■	■
Side handle	■	■	■
Drilling depth guide	■	■	■
Plastic carry case		■	■

<sup>1)</sup> also available in 120 V (North/Latin America)  
<sup>2)</sup> also available in 110 V (UK)

Product advantages

- Selectable "impuls" mode for removal of stubborn screws and for spot-drilling on smooth surfaces
- Variospeed (V) Electronics for working at customised speeds to suit various application materials
- Thumbwheel for speed preselection
- Forward and reverse rotation
- Spindle with hexagonal recess for screwdriver bits for working without chuck

System components

Accessories → 245



Technical data	Impact Drill SB 760	Impact Drill SBE 760	Impact Drill SBE 780-2
Rated input power	760 W	760 W	780 W
Output power	370 W	370 W	470 W
Maximum torque	24 Nm/9 Nm	24 Nm/9 Nm	32 Nm/13 Nm
Drill-Ø masonry	18 mm	18 mm	20 mm
Drill-Ø concrete	16 mm	16 mm	18 mm
Drill Ø steel	13 mm/8 mm	13 mm/8 mm	13 mm/8 mm
Drill-Ø soft wood	40 mm/25 mm	40 mm/25 mm	40 mm/25 mm
No-load speed	1,200/3,200 /min	0 - 1,200 / 0 - 3,200 /min	0 - 1,100 / 0 - 3,100 /min
Revolutions at rated load	800/2,300 /min	800/2,300 /min	680/1,900 /min
Maximum impact rate	58,000 /min	58,000 /min	58,900 /min
Gears	2	2	2
Chuck capacity	1.5 - 13 mm	1.5 - 13 mm	1.5 - 13
Collar diameter	43 mm	43 mm	43 mm
Drill spindle with hexagonal recess	1/4" (6.35 mm)	1/4" (6.35 mm)	1/4" (6.35 mm)
Drill spindle thread	1/2 " - 20 UNF	1/2 " - 20 UNF	1/2 " - 20 UNF
Weight (without mains cable)	2.3 kg	2.3 kg	2.6 kg
Cable length	2.5 m	2.5 m	4 m

Scope of delivery

Order no.	600840	600841 <sup>1) 2)</sup>	600781 <sup>1)</sup>
Geared chucks	■		
Chuck keys	■		
Futuro Plus keyless chuck		■	■
Side handle	■	■	
Rubber-coated side handle			■
Drilling depth guide	■	■	■
Plastic carry case		■	

<sup>1)</sup> also available in 120 V (North/Latin America)  
<sup>2)</sup> also available in 110 V (UK)

Product advantages

- Robust die cast aluminium gear housing for optimum heat dissipation and long service life
- Rotating carbon brush bridge for maximum performance even in anti-clockwise operation, e.g. for the removal of stubborn screws
- Metabo Marathon-motor with dust protection for long service life
- Variospeed (V) Electronics for working at customised speeds to suit various application materials
- Thumbwheel for speed preselection
- Forward and reverse rotation
- Metabo S-automatic safety clutch: mechanical decoupling of the drive for safe working should the tool stop unexpectedly

System components

Accessories → 245



Technical data	Impact Drill SB 850-2	Impact Drill SBE 850-2	Impact Drill SBE 850-2 S
Rated input power	850 W	850 W	850 W
Output power	490 W	490 W	490 W
Maximum torque	36 Nm/14 Nm	36 Nm/14 Nm	36 Nm/14 Nm
Drill-Ø masonry	20 mm	20 mm	20 mm
Drill-Ø concrete	18 mm	18 mm	18 mm
Drill Ø steel	13 mm/8 mm	13 mm/8 mm	13 mm/8 mm
Drill-Ø soft wood	40 mm/25 mm	40 mm/25 mm	40 mm/25 mm
No-load speed	1100 / 3100 /min	0 - 1,100 / 0 - 3,100 /min	0 - 1,100 / 0 - 3,100 /min
Revolutions at rated load	640/1,800 /min	640/1,800 /min	640/1,800 /min
Maximum impact rate	58,900 /min	58,900 /min	58,900 /min
Gears	2	2	2
Chuck capacity	1.5 - 13 mm	1.5 - 13 mm	1.5 - 13 mm
Collar diameter	43 mm	43 mm	43 mm
Drill spindle with hexagonal recess	1/4" (6.35 mm)	1/4" (6.35 mm)	1/4" (6.35 mm)
Drill spindle thread	1/2" - 20 UNF	1/2" - 20 UNF	1/2" - 20 UNF
Weight (without mains cable)	2.6 kg	2.6 kg	2.6 kg
Cable length	4 m	4 m	4 m

Scope of delivery

Order no.	600780	600782 <sup>1) 2)</sup>	600787
Geared chucks	■		
Chuck keys	■		
Futuro Plus keyless chuck		■	■
Rubber-coated side handle	■	■	■
Drilling depth guide	■	■	■
Plastic carry case		■	■

<sup>1)</sup> also available in 120 V (North/Latin America)  
<sup>2)</sup> also available in 110 V (UK)

Product advantages

- Keyless chuck and spindle stop gear for convenient one-handed tool change
- Variospeed (V) Electronics for working at customised speeds to suit various application materials
- Thumbwheel for speed preselection
- Robust die cast aluminium gear housing for optimum heat dissipation and long service life
- Rotating carbon brush bridge for maximum performance even in anti-clockwise operation, e.g. for the removal of stubborn screws
- Metabo Marathon-motor with dust protection for long service life
- Metabo S-automatic safety clutch: mechanical decoupling of the drive for safe working should the tool stop unexpectedly
- Spindle with hexagonal recess for screwdriver bits for working without chuck

System components

Accessories → 245



Technical data	Impact Drill SBEV 1000-2	Impact Drill SBEV 1100-2 S
Rated input power	1,010 W	1,100 W
Output power	540 W	580 W
Maximum torque	40 Nm/14 Nm	42 Nm/15 Nm
Drill-Ø masonry	22 mm	24 mm
Drill-Ø concrete	20 mm	22 mm
Drill Ø steel	16 mm/10 mm	16 mm/10 mm
Drill-Ø soft wood	40 mm/25 mm	40 mm/25 mm
No-load speed	0 - 1,000 / 0 - 2,800 /min	0 - 1,100 / 0 - 3,100 /min
Revolutions at rated load	1,000/2,800 /min	1,100/3,100 /min
Maximum impact rate	53,200 /min	58,900 /min
Gears	2	2
Chuck capacity	1.5 - 13 mm	1.5 - 13 mm
Collar diameter	43 mm	43 mm
Drill spindle with hexagonal recess	1/4" (6.35 mm)	1/4" (6.35 mm)
Drill spindle thread	1/2" - 20 UNF	1/2" - 20 UNF
Chuck clamping type	Geared chucks	Keyless chuck
Weight (without mains cable)	2.7 kg	2.8 kg
Cable length	4 m	4 m

Scope of delivery

Order no.	600783 <sup>1)</sup>	600784 <sup>2)</sup>
Geared chucks	■	
Chuck keys	■	
Futuro Plus keyless chuck		■
Rubber-coated side handle	■	■
Drilling depth guide	■	■
Plastic carry case		■

<sup>1)</sup> also available in 120 V (North/Latin America)  
<sup>2)</sup> also available in 110 V (UK)

Product advantages

- Selectable "impuls" mode for removal of stubborn screws and for spot-drilling on smooth surfaces
- Keyless chuck and spindle stop gear for convenient one-handed tool change
- Overload protection: protects the motor from overheating
- Wear Indication for Carbon Brush
- Restart protection: prevents unintentional start-up after power supply interruption
- Vario-Tacho-Constamatic (VTC)-Full Wave Electronics for work with materials requiring customised speeds, which remain constant under load
- Robust die cast aluminium gear housing for optimum heat dissipation and long service life
- Rotating carbon brush bridge for maximum performance even in anti-clockwise operation, e.g. for the removal of stubborn screws
- Metabo Marathon-motor with dust protection for long service life
- Metabo S-automatic safety clutch: mechanical decoupling of the drive for safe working should the tool stop unexpectedly

System components

Accessories → 245



Technical data	Impact Drill SBEV 1300-2	Impact Drill SBEV 1300-2 S
Rated input power	1,300 W	1,300 W
Output power	730 W	730 W
Maximum torque	44 Nm/16 Nm	44 Nm/16 Nm
Drill-Ø masonry	24 mm	24 mm
Drill-Ø concrete	22 mm	22 mm
Drill Ø steel	16 mm/10 mm	16 mm/10 mm
Drill-Ø soft wood	40 mm/25 mm	40 mm/25 mm
No-load speed	0 - 1,100 / 0 - 3,100 /min	0 - 1,100 / 0 - 3,100 /min
Revolutions at rated load	1,100/3,100 /min	1,100/3,100 /min
Maximum impact rate	58,900 /min	58,900 /min
Gears	2	2
Chuck capacity	1.5 - 13 mm	1.5 - 13 mm
Collar diameter	43 mm	43 mm
Drill spindle with hexagonal recess	1/4" (6.35 mm)	1/4" (6.35 mm)
Drill spindle thread	1/2" - 20 UNF	1/2" - 20 UNF
Chuck clamping type	Geared chucks	Keyless chuck
Weight (without mains cable)	2.8 kg	2.8 kg
Cable length	4 m	4 m

Scope of delivery	600785	600786
Order no.	600785	600786
Geared chucks	■	
Chuck keys	■	
Futuro Plus keyless chuck		■
Rubber-coated side handle	■	■
Drilling depth guide	■	■
Plastic carry case		■

- Product advantages**
- Keyless chuck and spindle stop gear for convenient one-handed tool change
  - Vario-Tacho-Constamatic (VTC)-Full Wave Electronics for work with materials requiring customised speeds, which remain constant under load
  - Thumbwheel for speed preselection
  - Selectable "impuls" mode for removal of stubborn screws and for spot-drilling on smooth surfaces
  - Robust die cast aluminium gear housing for optimum heat dissipation and long service life
  - Rotating carbon brush bridge for maximum performance even in anti-clockwise operation, e.g. for the removal of stubborn screws
  - Metabo Marathon-motor with dust protection for long service life
  - Metabo S-automatic safety clutch: mechanical decoupling of the drive for safe working should the tool stop unexpectedly
  - Overload protection: protects the motor from overheating
  - Restart protection: prevents unintentional start-up after power supply interruption
  - Wear Indication for Carbon Brush

**System components**

Accessories → 245

## Chucks: Precise fitting parts and a long service life.

Simple handling, secure fit and long service life are the quality factors of a quality chuck. The Metabo Futuro Top chucks have a spring-loaded bit clamping mechanism for precise fit, and the hardened and ground components (clamping jaws, guide sleeve and the chuck body) of the chuck ensure a long service life and precise working.

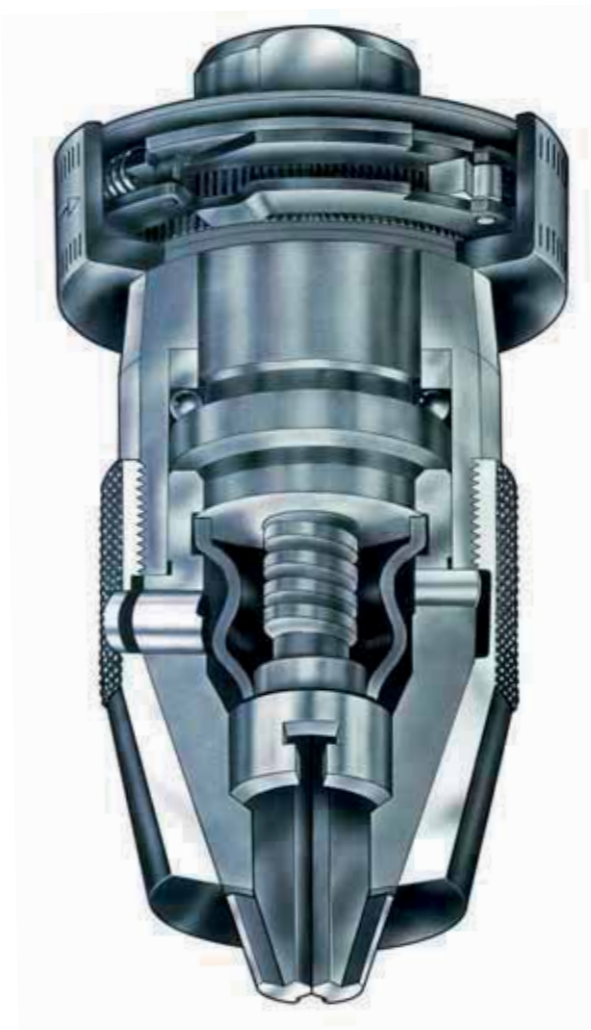

**Metabo Futuro Top keyless chuck**

**Spring-loaded safety feature**  
To ensure secure grip of the drill bit, even under the toughest possible continuous operating conditions of 62,000 strokes/min.

**Dual dust protection**  
Any dust that gets between the jaw guide and the rubber bellow is ejected through the openings in the chuck sleeve.

A hard-wearing, oil-resistant rubber bellows system protects the thread and the precision press fit from contamination.

**Precise fitting parts and a long service life**  
All of the heavily used parts of the chuck are hardened. The clamping jaws, the guide sleeves and the chuck body have a ground finish.



**Easy to use**  
The chuck can be opened easily and conveniently even after it has been used for tough drilling or impact drilling jobs.



**Warranty for optimal quality**  
The individual parts of the chucks pass through in excess of 30 inspection points during the course of manufacture.





After assembly, each chuck is checked thoroughly for concentric operation and functional safety.

Chucks

Keyless chucks, impact-proof

	Clamping width mm	Female thread	Outer Ø mm	Length (closed) mm	Weight kg	Order no.
	<b>Futuro Top keyless chucks, R</b>					
	<ul style="list-style-type: none"> <li>■ The first impact-proof keyless chuck, with integrated spring-loaded bit clamping mechanism and dual dust protection</li> <li>■ Keyless for quick tool change</li> <li>■ Firm grip of clamped tools even under the toughest loads</li> <li>■ The oil-resistant, hard-wearing rubber bellows system protects the thread and the precision press fit from dust and dirt</li> <li>■ For clockwise rotating drills only</li> </ul>					
	1 - 10	3/8"-24 UNF	42.8	77	0.35	636215000
	1 - 10	1/2"-20 UNF	42.8	77	0.35	636216000
	1 - 10	B12	42.8	77	0.35	636217000
	1 - 13	3/8"-24 UNF	42.8	89	0.5	636225000
	1 - 13	1/2"-20 UNF	42.8	89	0.5	636226000
	1 - 13	B16	42.8	103	0.6	636227000
	3 - 16	5/8" - 16 UN	50	113	1	636241000
	3 - 16	B16	50	113	1	636242000
	3 - 16	B18	50	113	1	636243000
	1 - 10	1/2"-20 UNF	42.8	77	0.35	636601000*
	1 - 13	1/2"-20 UNF	42.8	89	0.5	636602000*

	<b>Futuro Plus keyless chucks S1 M, R+L</b>					
	<ul style="list-style-type: none"> <li>■ Special design for impact drills with spindle stop</li> <li>■ Sturdy design with metal sleeve</li> <li>■ Single sleeve (without supporting ring)</li> <li>■ Keyless for quick tool change</li> <li>■ Impact-proof design</li> <li>■ Drills through using locking screw for clockwise and anti-clockwise operating machines</li> <li>■ With spanner flat for assembly and disassembly</li> </ul>					
1.5 - 13	1/2"-20 UNF	42.9	72.4	0.3	636621000*	636625000*
<b>Chuck display</b>						
■ Contents: 6 pieces Futuro Plus S1M (636621000) 13 mm, 1/2" in counter display						

	<b>Futuro Plus keyless chucks S1, R + L</b>					
	<ul style="list-style-type: none"> <li>■ Specially developed for lightweight impact drills with spindle stop</li> <li>■ Plastic sleeve</li> <li>■ Single sleeve (without supporting ring)</li> <li>■ Keyless for quick tool change</li> <li>■ Impact-proof design</li> <li>■ Drills through using locking screw for clockwise and anti-clockwise operating machines</li> <li>■ With spanner flat for assembly and disassembly</li> </ul>					
	1 - 10	3/8"-24 UNF	42.7	61	0.2	636615000*
	1 - 10	1/2"-20 UNF	42.7	61	0.2	636616000*
1.5 - 13	1/2"-20 UNF	42.7	72.4	0.2	636617000*	

	<b>Futuro Plus keyless chucks S2 M, R + L</b>					
	<ul style="list-style-type: none"> <li>■ Specially developed for impact drills</li> <li>■ Sturdy design with metal sleeve. Version 636619000 with hardened carbide jaws</li> <li>■ Double sleeve with radial locking for secure tool clamping</li> <li>■ Keyless for quick tool change</li> <li>■ Impact-proof design</li> <li>■ Drills through using locking screw for clockwise and anti-clockwise operating machines</li> <li>■ With spanner flat for assembly and disassembly</li> </ul>					
	1.5 - 13	1/2"-20 UNF	42.9	72.4	0.3	636620000*
	1.5 - 13	1/2"-20 UNF	42.9	72.4	0.3	636619000*
<b>Chuck display</b>						
■ Contents: 6 pieces Futuro Plus S2M (636620000) 13 mm, 1/2" in counter display						

\*Self-service packaging

	Clamping width mm	Female thread	Outer Ø mm	Length (closed) mm	Weight kg	Order no.
	<b>Futuro Plus keyless chucks S2, R + L</b>					
	<ul style="list-style-type: none"> <li>■ Specially developed for lightweight impact drills</li> <li>■ Plastic sleeve</li> <li>■ Double sleeve with radial locking for secure tool clamping</li> <li>■ Keyless for quick tool change</li> <li>■ Impact-proof design</li> <li>■ Drills through using locking screw for clockwise and anti-clockwise operating machines</li> <li>■ With spanner flat for assembly and disassembly</li> </ul>					
	1 - 10	3/8"-24 UNF	42.8	61	0.2	636612000*
1 - 10	1/2"-20 UNF	42.8	61	0.2	636613000*	
1.5 - 13	1/2"-20 UNF	42.8	72.4	0.2	636614000*	

Keyless chucks, not impact-proof

	Clamping width mm	Female thread	Outer Ø mm	Length (closed) mm	Weight kg	Order no.
	<b>Futuro R keyless chucks</b>					
	<ul style="list-style-type: none"> <li>■ Keyless clamping of insertion tools to hand-held and fixed drills</li> <li>■ The chuck readjusts its tension to match the increasing cutting pressure on the cutting bit</li> <li>■ The chuck can be opened easily by hand even after the toughest drilling jobs</li> <li>■ For maximum load</li> <li>■ For clockwise rotating drills only</li> <li>■ Not impact-proof</li> </ul>					
	1 - 10	3/8"-24 UNF	37.5	77	0.35	636321000
	1 - 10	1/2"-20 UNF	37.5	77	0.35	636322000
	1 - 10	B12	37.5	77	0.35	636323000
	1 - 10	B16	40.5	103	0.6	636333000
	1 - 13	3/8"-24 UNF	40.5	89	0.6	636341000
	1 - 13	1/2"-20 UNF	40.5	89	0.6	636342000
	1 - 13	B16	40.5	103	0.6	636343000
	1 - 13	1/2"-20 UNF	47.5	111	0.8	636351000
	1 - 13	B16	47.5	111	0.8	636353000
	1 - 13	J6	47.5	111	0.8	636356000
	3 - 16	5/8"-16 UN	50	113	1	636361000
	3 - 16	B16	50	113	1	636362000
	3 - 16	B18	50	113	1	636363000
	3 - 16	J6	50	113	1	636364000

	<b>Futuro Plus keyless chucks H2, R + L</b>					
	<ul style="list-style-type: none"> <li>■ Specially developed for cordless and lightweight drills</li> <li>■ Plastic sleeve</li> <li>■ Double sleeve with supporting ring for firm grip of tools</li> <li>■ Keyless for quick tool change</li> <li>■ Not impact-proof</li> <li>■ Drills through using locking screw for clockwise and anti-clockwise operating machines</li> <li>■ With spanner flat for assembly and disassembly</li> </ul>					
	1 - 10	3/8"-24 UNF	42.7	61	0.2	636518000*
	1 - 10	1/2"-20 UNF	42.7	61	0.2	636519000*
1.5 - 13	1/2"-20 UNF	42.7	72.4	0.2	636520000*	

Guide for chuck designations:

- B = conical
- J = Jacobs
- S = impact-proof
- 1 or 2 = number of sleeves
- M = metal version
- R = for clockwise rotation
- R+L = for clockwise and anticlockwise rotation

Clamping width mm	Female thread	Outer Ø mm	Length (closed) mm	Weight kg	Order no.
 <p><b>Futuro Plus keyless chucks H1, R + L</b></p> <ul style="list-style-type: none"> <li>Special design for drills with spindle stop</li> <li>Plastic sleeve</li> <li>Single sleeve without supporting ring</li> <li>Keyless for quick tool change</li> <li>Not impact-proof</li> <li>Drills through using locking screw for clockwise and anti-clockwise operating machines</li> <li>With spanner flat for assembly and disassembly</li> </ul>					
1 - 10	1/2"-20 UNF	40	49	0.15	636219000*
1 - 10	3/8"-24 UNF	42.7	61	0.2	636515000*
1 - 10	1/2"-20 UNF	42.7	61	0.2	636516000*
1.5 - 13	1/2"-20 UNF	42.7	72.4	0.2	636517000*
1.5 - 13	1/2"-20 UNF	42.7	61	0.2	636609000*

 <p><b>Futuro Plus keyless chucks H1 M, R+L</b></p> <ul style="list-style-type: none"> <li>Special design for drills with spindle stop</li> <li>Single sleeve (without supporting ring)</li> <li>Keyless for quick tool change</li> <li>Not impact-proof</li> <li>With spanner flat for assembly and disassembly</li> </ul>					
0.8 - 6.5	1/2"-20 UNF	34	57	0.14	636623000*

**Geared chucks, impact-proof**

Clamping width mm	Female thread	Outer Ø mm	Length (closed) mm	Weight kg	Key size	Order no.
 <p><b>Geared chucks with key, clockwise rotation</b></p> <ul style="list-style-type: none"> <li>Tried and tested 1000 times</li> <li>The chuck for every type of job</li> <li>With female thread or female taper for hand-held or fixed drills as well as for hand-held impact drills</li> <li>The clamping force remains constant during drilling and impact drilling</li> <li>For clockwise rotating drills only</li> </ul>						
0.5 - 6.5	3/8"-24 UNF	30	53	0.17	1	635008000
1 - 10	3/8"-24 UNF	33.3	61	0.21	2	635019000
1 - 10	1/2"-20 UNF	33.3	61	0.2	2	635072000
1.5 - 13	3/8"-24 UNF	42.5	74	0.32	2	635033000
1.5 - 13	1/2"-20 UNF	42.5	74	0.31	2	635035000
1.5 - 13	1/2"-20 UNF	42.5	74	0.31	2	635302000*
1.5 - 13	B16	42.5	78	0.35	2	635036000
3 - 16	1/2"-20 UNF	50	87.5	0.6	3	635054000
3 - 16	5/8"-16 UN	50	87.5	0.59	3	635056000
3 - 16	B16	50	86	0.64	3	635050000
3 - 16	B18	50	94.5	0.63	3	635049000
5 - 20	B22	65	113	0.75	4	635058000

 <p><b>Geared chucks with key, R + L</b></p> <ul style="list-style-type: none"> <li>Tried and tested 1000 times</li> <li>The chuck for every type of job</li> <li>With female thread or female taper for hand-held or fixed drills as well as for hand-held impact drills</li> <li>The clamping force remains constant during drilling and impact drilling</li> <li>Drills through using locking screw for clockwise and anti-clockwise operating machines</li> </ul>						
1 - 10	3/8"-24 UNF	33.3	61	0.17	2	635254000
1 - 10	1/2"-20 UNF	33.3	61	0.17	2	635252000
1.5 - 13	3/8"-24 UNF	42.5	74	0.31	2	635255000
1.5 - 13	1/2"-20 UNF	42.5	74	0.31	2	635250000
3 - 16	5/8"-16 UN	50	87.5	0.6	2	635253000
1.5 - 13	1/2"-20 UNF	42.5	74	0.32	2	635304000*

**Chuck Accessories**

**Spare chuck keys**

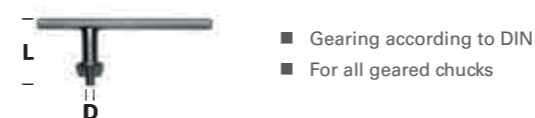

Key size	Spigot Ø D mm	Shaft length L mm	Order no.
1	4	30	635165000*
2	6	42	635167000*
3	8	50	635168000*
4	9	55	635169000*

**Morse tapers for chucks**

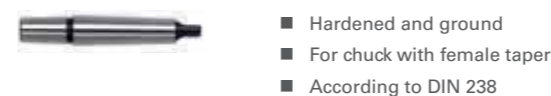

Outer morse taper Ø	Chuck cone	Overall morse taper length mm	Weight kg	Order no.
MK 1	B 12	89	0.065	635104000
MK 1	B 16	97	0.09	635105000
MK 2	B 12	106.5	0.135	635114000
MK 2	B 16	110.5	0.16	635115000
MK 2	B 18	117.5	0.18	635116000
MK 3	B 16	134	0.31	635125000
MK 3	B 18	141	0.32	635126000
MK 3	B 22	147	0.39	635128000
MK 4	B 16	159	0.625	635132000
MK 4	B 18	168	0.66	635133000

**Reducing Inserts**



Outer morse taper Ø	Internal morse taper Ø	Overall length mm	Weight kg	Order no.
MK 3	MK 2	112	0.19	635143000
MK 4	MK 2	124	0.48	635144000
MK 4	MK 3	140	0.36	635146000



**Drift keys**

- Hardened industrial version
- for separation of morse taper and tool

Suitable for machine with morse taper	Overall length mm	Weight kg	Order no.
MK 1, MK 2	140	0.07	642395000
MK 3	190	0.15	642396000

\*Self-service packaging

Accessories for »Quick« drills and drills/screwdrivers		Order no.
	<p><b>PowerX3 torque setting adapter</b></p> <ul style="list-style-type: none"> <li>The torque setting adapter enables the power of the tool (torque) to be tripled to handle tough jobs</li> <li>Suitable for all Metabo cordless drills/screwdrivers, cordless hammer drills and drills with Metabo »Quick«- quick change system in combination with 43 mm collet</li> <li>Standard equipment incl. bit (1 x TX 50) and adapter for adjusting the handle length</li> <li>Bit retainer with 1/2" male square and 1/4" (6.35 mm) female hexagon socket</li> </ul> <p>Attention: Use the PowerX3 in conjunction with the following tools only and using the stipulated length of the handle depending on the torque: all cordless drill/screwdrivers and LTX "Quick " impact drills as well as BE 75 Quick drill: 640 mm handle length; BE 1300 Quick drill: 380 mm handle length.</p>	627256000
	<p><b>Quick-change geared chuck »Quick«</b></p> <ul style="list-style-type: none"> <li>Simple, fast and convenient chuck change thanks to the Metabo Quick change system</li> <li>Impact-proof version; suitable for clockwise and anti-clockwise rotation</li> <li>Clamping width: 1.5 - 13 mm</li> <li>Suitable for all Metabo »Quick« machines</li> </ul>	627238000*
	<p><b>Quick-change chuck Futuro Plus S 1 M, »Quick«</b></p> <ul style="list-style-type: none"> <li>Simple, fast and convenient chuck change thanks to the Metabo Quick change system</li> <li>Stable version with metal sleeve; 1 sleeve; impact-resistant version; suitable for clockwise and anti-clockwise rotation</li> <li>Clamping width: 1.5 - 13 mm</li> <li>Suitable for all Metabo »Quick« machines</li> </ul>	627240000*
	<p><b>Quick-change chuck Futuro Plus H 1 R+L, »Quick«</b></p> <ul style="list-style-type: none"> <li>Simple, fast and convenient chuck change thanks to the Metabo Quick change system</li> <li>Version with metal sleeve; 1 sleeve; impact-resistant model; suitable for clockwise and anti-clockwise rotation</li> <li>Clamping width: 1.0 - 10 mm</li> <li>Suitable for all Metabo »Quick« machines</li> </ul>	627259000*
	<p><b>Quick-change chuck Futuro Plus H 1 R+L, »Quick«</b></p> <ul style="list-style-type: none"> <li>Simple, fast and convenient chuck change thanks to the Metabo Quick change system</li> <li>Compact version with plastic sleeve; 1 sleeve; impact-resistant model; suitable for clockwise and anti-clockwise rotation</li> <li>Clamping width: 1.5 - 13 mm</li> <li>Suitable for all Metabo »Quick« machines</li> </ul>	636608000*
	<p><b>Quick change threaded chuck M4 - M6</b></p> <ul style="list-style-type: none"> <li>Keyless chuck for inserting taps with square and cylindrical shanks</li> <li>Simple, fast and convenient chuck change thanks to the Metabo Quick change system</li> <li>Version with metal sleeve; 1 sleeve; impact-resistant model; suitable for clockwise and anti-clockwise rotation</li> <li>Clamping width: 1.5-8 mm; drill chuck with square holder 3.5 mm for M4 and 5.0 mm for M6</li> <li>Suitable for all Metabo »Quick« machines</li> </ul>	627235000*
	<p><b>Quick change threaded chuck M8 - M12</b></p> <ul style="list-style-type: none"> <li>Keyless chuck for inserting taps with square and cylindrical shanks</li> <li>Simple, fast and convenient chuck change thanks to the Metabo Quick change system</li> <li>Version with metal sleeve; 1 sleeve; impact-resistant model; suitable for clockwise and anti-clockwise rotation</li> <li>Clamping width: 1.5-13 mm; chuck with square holder 6.0 mm for M8 and 8.1 mm for M10 and M12</li> <li>Suitable for all Metabo »Quick« machines</li> </ul>	627237000*
	<p><b>Quick-change bit holder »Quick«</b></p> <ul style="list-style-type: none"> <li>Easy, fast and comfortable change of the bit holder thanks to Metabo quick change system »Quick«</li> <li>Bit holder suitable for bits with 1/4" external hexagonal drive according to DIN 3126- C 6.3 and E 6.3</li> <li>Suitable for all Metabo »Quick« machines</li> </ul>	627241000*

		Order no.
	<p><b>Quick-change angle adapter »Quick«</b></p> <ul style="list-style-type: none"> <li>Quick and comfortable fixing of angle adapter without tools</li> <li>Quick spindle for fixing the quick change angle adapter 627240000 and bit holder 627241000</li> <li>Magnetic bit holder with 1/4" (6.35 mm) hexagonal shank</li> <li>Suitable for forward and reverse rotation</li> <li>Suitable for cordless machines up to a maximum of 110 Nm</li> <li>Suitable for all Metabo »Quick« machines with collet Ø 43 mm</li> </ul>	627242000*
	<p><b>Quick-change angle adapter »Quick«</b></p> <ul style="list-style-type: none"> <li>Quick and comfortable fixing of angle adapter without tools</li> <li>Quick spindle for fixing the quick change angle adapter 627240000 and bit holder 627241000</li> <li>Magnetic bit holder with 1/4" (6.35 mm) hexagonal shank</li> <li>Suitable for forward and reverse rotation</li> <li>Suitable for cordless machines up to a maximum of 100 Nm</li> <li>Suitable for all Metabo LT »Quick« models (from year of construction 02/2013)</li> </ul>	627077000*
	<p><b>Quick-change angle adapter »Quick«</b></p> <ul style="list-style-type: none"> <li>For drilling and fixing screws in hard to reach places</li> <li>Magnetic bit holder with 1/4" (6.35 mm) hexagonal shank</li> <li>Gears made of special steel</li> <li>Suitable for forward and reverse rotation; up to max. 28 Nm</li> <li>Especially for PowerMaxx BS Quick and BS 18 Quick</li> </ul>	627261000*

- 01
- 02
- 03
- 04
- 05
- 06
- 07
- 08
- 09
- 10
- 11
- 12
- 13
- 14
- 15

\*Self-service packaging

# Metal Drill Bits

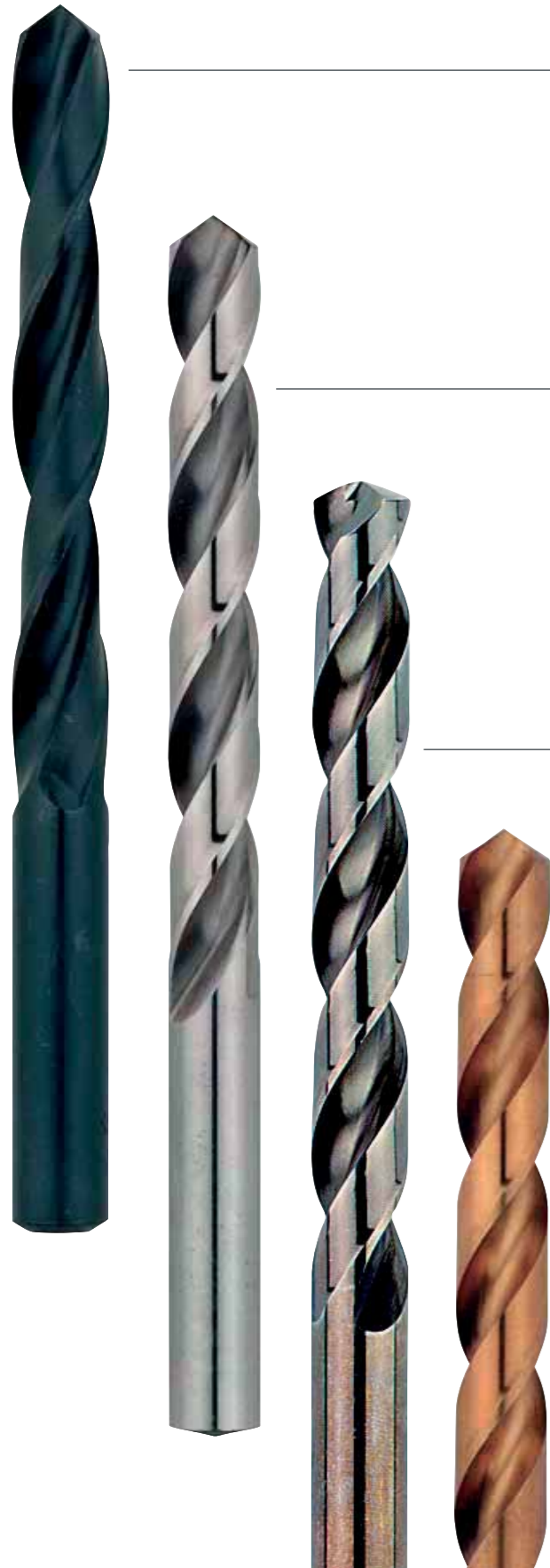

## HSS-R Metal drill bits, DIN 338, roll-milled

Spiral drill bit made of high-grade high-speed steel according to DIN 338, roll-milled, cylindrical, right-hand cutting, type N, black surface

**Application:**  
Suitable for drilling in the common metals such as steel, non-ferrous metals, alloyed and non-alloyed cast steel. Up to 900 N/mm<sup>2</sup> tensile strength.

## HSS-G metal drill bits, DIN 338, ground

Precision spiral drill bit made of high-grade high-speed steel according to DIN 338, precision ground, cylindrical, right-hand cutting, type N, crosswise grinding 135° according to DIN 1412 C (from 3 mm), polished surface

**Application:**  
For maximum load and precision in crafts and industry. For drilling in steel and cast steel, alloyed and unalloyed, grey cast iron, sintered iron, nickel silver, graphite etc. Up to 900 N/mm<sup>2</sup> tensile strength.

## HSS-Co metal drill bits, DIN 338, ground

Precision spiral drill bit made of cobalt-alloyed high-grade high-speed steel according to DIN 338, precision-ground, cylindrical, type N, reinforced core thickness, with crosswise grinding 135° (from 2 mm) according to DIN 1412 C, bronze surface

**Application:**  
For maximum load and precision in crafts and industry. For drilling hard-to-machine materials such as heat, corrosion and acid resistant steels, VA steel, special alloys, welded seams, CrNi-steels. Up to 1100 N/mm<sup>2</sup> tensile strength.

## HSS-TiN metal drill bits, DIN 338, ground

Precision spiral drill made of titanium coated high-grade high-speed steel according to DIN 338, precision ground, cylindrical, right-hand cutting, type N, crosswise ground 135° (from 3 mm upwards) to DIN 1412 C, gold colour surface finish.

**Application:**  
For maximum load and precision in crafts and industry. For drilling steel and cast-steel, alloyed and non-alloyed, grey cast iron, annealed cast-iron, nickel silver, graphite, bronze and brass. Up to 900 N/mm<sup>2</sup> tensile strength. HSS-TiN drill bits are not suited for processing aluminium.

# Metal Drill Bits

## HSS-R metal drill bits, DIN 338, roll-milled



- Spiral drill bit made of high-grade high-speed steel according to DIN 338, roll-milled, cylindrical, right-hand cutting, type N
- Cone-shaped shell polished surface 118°, diameter tolerance h8
- Black surface
- Suitable for drilling in steel, non-ferrous metals, alloyed and non-alloyed cast steel. Up to 900 N/mm<sup>2</sup> tensile strength.

Diameter mm	Overall length mm	Working length mm	Sales unit	Order no.
1	34	12	10	627700000*
1.1	36	14	10	627701000*
1.2	38	16	10	627702000*
1.3	38	16	10	627703000*
1.4	40	18	10	627704000*
1.5	40	18	10	627705000*
1.6	43	20	10	627706000*
1.7	43	20	10	627707000*
1.8	46	22	10	627708000*
1.9	46	22	10	627709000*
2	49	24	10	627710000*
2.1	49	24	10	627711000*
2.2	53	27	10	627712000*
2.3	53	27	10	627713000*
2.4	57	30	10	627714000*
2.5	57	30	10	627715000*
2.6	57	30	10	627716000*
2.7	61	33	10	627717000*
2.8	61	33	10	627718000*
2.9	61	33	10	627719000*
3	61	33	10	627720000*
3.1	65	36	10	627721000*
3.2	65	36	10	627722000*
3.3	65	36	10	627723000*
3.4	70	39	10	627724000*
3.5	70	39	10	627725000*
3.6	70	39	10	627726000*
3.7	70	39	10	627727000*
3.8	75	43	10	627728000*
3.9	75	43	10	627729000*
4	75	43	10	627730000*
4.1	75	43	10	627731000*
4.2	75	43	10	627732000*
4.3	80	47	10	627733000*
4.4	80	47	10	627734000*
4.5	80	47	10	627735000*
4.6	80	47	10	627736000*
4.7	80	47	10	627737000*
4.8	86	52	10	627738000*
4.9	86	52	10	627739000*
5	86	52	10	627740000*
5.1	86	52	10	627741000*
5.2	86	52	10	627742000*
5.3	93	57	10	627743000*
5.4	93	57	10	627744000*
5.5	93	57	10	627745000*
5.6	93	57	10	627746000*
5.7	93	57	10	627747000*
5.8	93	57	10	627748000*
5.9	93	57	10	627749000*
6	93	57	10	627750000*
6.1	101	63	10	627751000*
6.2	101	63	10	627752000*
6.3	101	63	10	627753000*

\*Self-service packaging

Diameter mm	Overall length mm	Working length mm	Sales unit	Order no.
6.4	101	63	10	627754000*
6.5	101	63	10	627755000*
6.6	101	63	10	627756000*
6.7	101	63	10	627757000*
6.8	109	69	10	627758000*
6.9	109	69	10	627759000*
7	109	69	10	627760000*
7.1	109	69	10	627761000*
7.2	109	69	10	627762000*
7.3	109	69	10	627763000*
7.4	109	69	10	627764000*
7.5	109	69	10	627765000*
7.6	117	75	10	627766000*
7.7	117	75	10	627767000*
7.8	117	75	10	627768000*
7.9	117	75	10	627769000*
8	117	75	10	627770000*
8.1	117	75	10	627771000*
8.2	117	75	10	627772000*
8.3	117	75	10	627773000*
8.4	117	75	10	627774000*
8.5	117	75	10	627775000*
8.6	125	81	10	627776000*
8.7	125	81	10	627777000*
8.8	125	81	10	627778000*
8.9	125	81	10	627779000*
9	125	81	10	627780000*
9.1	125	81	10	627781000*
9.2	125	81	10	627782000*
9.3	125	81	10	627783000*
9.4	125	81	10	627784000*
9.5	125	81	10	627785000*
9.6	133	87	10	627786000*
9.7	133	87	10	627787000*
9.8	133	87	10	627788000*
9.9	133	87	10	627789000*
10	133	87	10	627790000*
10.2	133	87	5	627792000*
10.5	133	87	5	627795000*
11	142	94	5	627800000*
11.5	142	94	5	627805000*
12	151	101	5	627810000*
12.5	151	101	5	627815000*
13	151	101	5	627820000*
	<b>HSS-R drill bit storage case</b> 6 pieces, in plastic storage case Ø 2 / 3 / 4 / 5 / 6 / 8 mm			627160000*
	<b>HSS-R drill bit storage case</b> 10 pieces, in plastic carry case Ø 1 / 2 / 3 / 4 / 5 / 6 / 7 / 8 / 9 / 10 mm			627158000*
	<b>HSS-R drill bit storage case</b> 13 pieces, in plastic storage case Ø 1.5 / 2 / 2.5 / 3 / 3.2 / 3.5 / 4 / 4.5 / 4.8 / 5 / 5.5 / 6 / 6.5 mm			627161000*
	<b>HSS-R drill bit storage case</b> 13 pieces, in plastic storage case Ø 2 / 2.5 / 3 / 3.5 / 4 / 4.5 / 5 / 5.5 / 6 / 6.5 / 7 / 7.5 / 8 mm			627162000*
	<b>HSS-R drill bit storage case</b> 19 pieces, in robust plastic storage case Ø 1 / 1.5 / 2 / 2.5 / 3 / 3.5 / 4 / 4.5 / 5 / 5.5 / 6 / 6.5 / 7 / 7.5 / 8 / 8.5 / 9 / 9.5 / 10 mm			627164000*

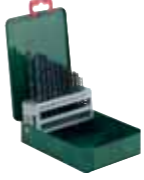
	Order no.
 <b>HSS-R drill bit storage case</b> 25 pieces, in robust plastic storage case Ø 1 / 1.5 / 2 / 2.5 / 3 / 3.5 / 4 / 4.5 / 5 / 5.5 / 6 / 6.5 / 7 / 7.5 / 8 / 8.5 / 9 / 9.5 / 10 / 10.5 / 11 / 11.5 / 12 / 12.5 / 13 mm	627159000*
 <b>HSS-R drill bit storage case</b> 36 pieces, in metal case 5x Ø 2 / 2.5 / 3 / 3.5 mm; 3x Ø 4 / 4.5 / 5 / 5.5 mm; 2x 6 / 6.5 mm	627174000*

**HSS-R Metal drill bits, DIN 338, with offset shank**



- Spiral drill bit made of high-grade high-speed steel according to DIN 338, roll-milled, cylindrical, right-hand cutting, type N
- Cone-shaped shell polished surface 118°, diameter tolerance h8
- Black surface
- Suitable for drilling in steel, non-ferrous metals, alloyed and non-alloyed cast steel. Up to 900 N/mm<sup>2</sup> tensile strength.

Diameter mm	Overall length mm	Working length mm	Shaft Ø mm	Sales unit	Order no.
13.5	160	108	10	1	625006000*
14	160	108	10	1	625007000*
15	169	114	10	1	625009000*
16	178	120	10	1	625011000*
17	184	125	13	1	625013000*
18	191	130	13	1	625015000*
19	198	135	13	1	625017000*
20	205	140	13	1	625019000*

**HSS-G metal drill bits, DIN 338, ground**



- Precision spiral drill bit made of high-grade high-speed steel according to DIN 338, precision ground, cylindrical, right-hand cutting, type N, crosswise grinding 135° according to DIN 1412 C (from 3 mm), diameter tolerance h8
- Bare surface
- For highest demands and precision in industry and crafts.
- For drilling steels, cast steel, alloyed and unalloyed, grey cast iron, tempered cast iron, ductile cast iron, sintered iron, nickel silver, graphite, NF metals, plastic. Up to 900 N/mm<sup>2</sup> tensile strength.

Diameter mm	Overall length mm	Working length mm	Sales unit	Order no.
1	34	12	10	627852000*
1.5	40	18	10	627857000*
2	49	24	10	627862000*
2.5	57	30	10	627867000*
3	61	33	10	627872000*
3.2	65	36	10	627874000*
3.3	65	36	10	627875000*
3.5	70	39	10	627877000*
4	75	43	10	627882000*
4.1	75	43	10	627883000*
4.2	75	43	10	627884000*
4.5	80	47	10	627887000*
4.8	86	52	10	627890000*
5	86	52	10	627892000*
5.1	86	52	10	627893000*
5.2	86	52	10	627894000*

\*Self-service packaging



Diameter mm	Overall length mm	Working length mm	Sales unit	Order no.
5.5	93	57	10	627897000*
6	93	57	10	627902000
6.5	101	63	10	627907000
6.8	109	69	5	627910000
7	109	69	5	627912000
7.5	109	69	5	627917000
8	117	75	5	627922000
8.2	117	75	5	627924000
8.5	117	75	5	627927000
9	125	81	5	627932000
9.5	125	81	5	627937000
10	133	87	5	627942000
10.2	133	87	5	627943000
10.5	133	87	5	627944000
11	142	94	5	627945000
11.5	142	94	5	627946000
12	151	101	5	627947000
12.5	151	101	5	627948000
13	151	101	5	627949000
1	34	12	2	627950000*
1.5	40	18	2	627951000*
2	49	24	2	627952000*
2.5	57	30	2	627953000*
3	61	33	2	627954000*
3.2	65	36	2	627955000*
3.5	70	39	2	627957000*
4	75	43	2	627958000*
4.2	80	47	1	627960000*
4.5	80	47	1	627961000*
4.8	86	52	1	627962000*
5	86	52	1	627963000*
5.5	93	57	1	627966000*
6	93	57	1	627967000*
6.5	101	63	1	627968000*
6.8	109	69	1	627969000*
7	109	69	1	627970000*
7.5	109	69	1	627971000*
8	117	75	1	627973000*
8.5	117	75	1	627975000*
9	125	81	1	627976000*
9.5	125	81	1	627977000*
10	133	87	1	627978000*
10.5	133	87	1	627980000*
11	142	94	1	627981000*
11.5	142	94	1	627982000*
12	151	101	1	627983000*
12.5	151	101	1	627984000*
13	151	101	1	627985000*

HSS-G Metal drill bits long, DIN 340



- Precision spiral drill bit made of high-grade high-speed steel according to DIN 340, ground from the solid, long, cylindrical, right-hand cutting, type N, crosswise grinding 135° according to DIN 1412 C (from 3 mm), diameter tolerance h8
- Bare surface
- For highest demands and precision in industry and handcraft
- For drilling steels, cast steel, alloyed and unalloyed, grey cast iron, ductile cast iron, sintered iron, nickel silver, graphite. Up to 900 N/mm<sup>2</sup> tensile strength.

Diameter mm	Overall length mm	Working length mm	Sales unit	Order no.
2	85	56	1	625031000*
3	100	66	1	625033000*
4	119	78	1	625038000*
5	132	87	1	625043000*
6	139	91	1	625050000*
7	156	102	1	625053000*
8	165	109	1	625055000*
9	175	115	1	625057000*
10	184	121	1	625059000*
11	195	128	1	625062000*
12	205	134	1	625064000*
13	205	134	1	625066000*



**HSS-G drill bit storage case**  
6 pieces, in plastic storage case  
Ø 2 / 3 / 4 / 5 / 6 / 8 mm

01



**HSS-G drill bit storage case**  
13 pieces, in plastic storage case  
Ø 1.5 / 2 / 2.5 / 3 / 3.2 / 3.5 / 4 / 4.5 / 4.8 / 5 / 5.5 / 6 / 6.5 mm

02



**HSS-G drill bit storage case**  
19 pieces, in robust plastic carry case  
Ø 1 / 1.5 / 2 / 2.5 / 3 / 3.5 / 4 / 4.5 / 5 / 5.5 / 6 / 6.5 / 7 / 7.5 / 8 / 8.5 / 9 / 9.5 / 10 mm

03



**HSS-G drill bit storage case**  
25 pieces, in robust plastic storage case  
Ø 1 / 1.5 / 2 / 2.5 / 3 / 3.5 / 4 / 4.5 / 5 / 5.5 / 6 / 6.5 / 7 / 7.5 / 8 / 8.5 / 9 / 9.5 / 10 / 10.5 / 11 / 11.5 / 12 / 12.5 / 13 mm

04

05

06

07

08

09

10

HSS-G Metal drill bits, DIN 3126, with hexagonal shank



- High-quality precision tool made of the finest hardened steel
- Precision ground from one piece
- Ideal for the new generation of drills equipped with quick-change keyless chuck according to DIN 3126.
- Strict compliance with DIN 3126 E6.3 ensures that the chuck is not damaged.

Diameter mm	Overall length mm	Working length mm	Sales unit	Order no.
2	47	16	1	627514000*
3	47	16	1	627515000*
4	53	20	1	627516000*
5	59	26	1	627517000*
6	59	26	1	627518000*
8	60	32	1	627519000*



**HSS-G drill bit storage case**  
5 pieces, with hexagonal shank (E 6.3), in plastic storage case  
Ø 3 / 4 / 5 / 6 / 8 mm

11

12

13

14

15

\*Self-service packaging

HSS-Co. metal drill bits DIN 338



- Precision spiral drill bit made of cobalt-alloyed high-grade high-speed steel according to DIN 338, precision-ground, cylindrical, type N, reinforced core thickness, with crosswise grinding 135° according to DIN 1412 C (from 2 mm), diameter tolerance h8
- Bronze surface
- For exceptional demands and precision work in handcraft and industry
- For drilling in steel, VA-steel, cast steel, non-ferrous metals, plastics, special alloys, chrome vanadium steel up to 1100 N/mm<sup>2</sup> tensile strength

Diameter mm	Overall length mm	Working length mm	Sales unit	Order no.
1	34	12	2	627430000*
1.5	40	18	2	627431000*
2	49	24	2	627432000*
2.5	57	30	2	627433000*
3	61	33	2	627435000*
3.2	65	36	2	627436000*
3.3	65	36	2	627437000*
3.5	70	39	2	627438000*
4	75	43	2	627439000*
4.1	75	43	1	627440000*
4.2	75	43	1	627441000*
4.5	80	47	1	627442000*
4.8	86	52	1	627443000*
5	86	52	1	627444000*
5.1	86	52	1	627445000*
5.2	86	52	1	627446000*
5.5	93	57	1	627447000*
6	93	57	1	627448000*
6.5	101	63	1	627449000*
6.8	109	69	1	627450000*
7	109	69	1	627451000*
7.5	109	69	1	627452000*
8	117	75	1	627454000*
8.2	117	75	1	627455000*
8.5	117	75	1	627456000*
9	125	81	1	627457000*
9.5	125	81	1	627458000*
10	133	87	1	627459000*
10.2	133	87	1	627460000*
10.5	133	87	1	627461000*
11	142	94	1	627462000*
11.5	142	94	1	627463000*
12	151	101	1	627464000*
12.5	151	101	1	627465000*
13	151	101	1	627466000*



**HSS-Co drill bit storage case**  
6 pieces, in plastic storage case  
Ø 2 / 3 / 4 / 5 / 6 / 8 mm

627119000\*



**HSS-Co drill bit storage case**  
13 pieces, in plastic storage case  
Ø 1.5 / 2 / 2.5 / 3 / 3.2 / 3.5 / 4 / 4.5 / 4.8 / 5 / 5.5 / 6 / 6.5 mm

627120000\*

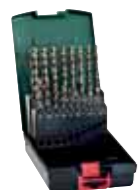

**HSS-Co drill bit storage case**  
19 pieces, in robust plastic storage case  
Ø 1 / 1.5 / 2 / 2.5 / 3 / 3.5 / 4 / 4.5 / 5 / 5.5 / 6 / 6.5 / 7 / 7.5 / 8 / 8.5 / 9 / 9.5 / 10 mm

627121000\*







**HSS-Co drill bit storage case**  
25 pieces, in robust plastic storage case  
Ø 1 / 1.5 / 2 / 2.5 / 3 / 3.5 / 4 / 4.5 / 5 / 5.5 / 6 / 6.5 / 7 / 7.5 / 8 / 8.5 / 9 / 9.5 / 10 / 10.5 / 11 / 11.5 / 12 / 12.5 / 13 mm

627122000\*

HSS-TiN metal drill bits, DIN 338

- Precision spiral drill bit made from TiN-coated high-speed steel, precision-ground, cylindrical, type N
- Not suitable for processing aluminium

	Order no.
 <b>HSS-TiN drill bit storage case</b> 6 pieces, in plastic storage case Ø 2 / 3 / 4 / 5 / 6 / 8 mm	627171000*
 <b>HSS-TiN drill bit storage case</b> 13 pieces, in plastic storage case Ø 1.5 / 2 / 2.5 / 3 / 3.2 / 3.5 / 4 / 4.5 / 4.8 / 5 / 5.5 / 6 / 6.5 mm	627176000*
 <b>HSS-TiN drill bit storage case</b> 19 pieces, in robust plastic storage case Ø 1 / 1.5 / 2 / 2.5 / 3 / 3.5 / 4 / 4.5 / 5 / 5.5 / 6 / 6.5 / 7 / 7.5 / 8 / 8.5 / 9 / 9.5 / 10 mm	627173000*
 <b>HSS-TiN drill bit storage case</b> 25 pieces, in robust plastic storage case Ø 1 / 1.5 / 2 / 2.5 / 3 / 3.5 / 4 / 4.5 / 5 / 5.5 / 6 / 6.5 / 7 / 7.5 / 8 / 8.5 / 9 / 9.5 / 10 / 10.5 / 11 / 11.5 / 12 / 12.5 / 13 mm	627191000*

HSS Form work drill bits, DIN 7490



- Spiral drill bit made of HSS steel for extra long tool life
- Corresponds to the safety requirements of the Wood Professional Association according to DIN 7490
- No clamping in drill hole, good chip removal
- For drilling through formwork in the construction industry as well as boards, beams, planks and floor boards made of soft and hard wood. Also suitable as a facade and roofer's drill bit for metal, profile sheets etc.

Diameter mm	Overall length mm	Sales unit	Order no.
6	400	1	627330000*
8	400	1	627331000*
10	400	1	627332000*
12	400	1	627333000*
14	400	1	627334000*
16	400	1	627335000*
18	400	1	627336000*
20	400	1	627337000*
22	400	1	627338000*
8	600	1	627401000*
10	600	1	627402000*
12	600	1	627403000*
14	600	1	627404000*
16	600	1	627405000*

Router bit



- Router bit made of HSS steel with very efficient routing spirals, crosswise grinding 135° according to DIN 1412 C, titanium nitride coating
- Extremely suitable for drilling and moulding/routing any contours in sheet metal and other thin-walled materials

Diameter mm	Overall length mm	Sales unit	Order no.
6	90	1	625150000*

\*Self-service packaging

# Masonry Drill bits, Universal Drill Bits



## Masonry drill bits, carbide-tipped

Very robust, high-grade masonry drill bits for rotary and impact drills, carbide insert 130°, milled angle groove, straight spiral intake, heat resistant, good durability and long service life.

**Application:**  
For drilling in concrete, masonry, natural stone

## Concrete drill bits, carbide-tipped, »classic« series

Concrete drill bit for rotary and impact drills, milled angle groove, straight spiral intake, long tool life, heat-resistant, carbide insert 130°, negative chamfer, robust version, surface shot peened

**Application:**  
For drilling in concrete, masonry, natural stone

## Concrete drill bits, carbide-tipped, »pro«

High-grade, robust concrete drill bit, carbide plate 130°, especially heat-resistant, very long tool life, with special groove for quick discharge of borehole cuttings, surface blank

**Application:**  
For drilling in granite, concrete, masonry, natural and artificial stone. Suitable for light rotary hammers with a three-jaw chuck

## Universal drill bits, carbide-tipped

Multi-purpose drill bit with cylindrical shaft for rotary, non-impact use, diamond ground carbide inserts and a positive aggressive cutting angle, ideally suited for use with cordless tools.



**Application:**  
For drilling in wood, metal, plastic, brick, gypsum boards, aerated concrete, tiles, ceramic, etc.

# Masonry Drill bits, Concrete Drill Bits

## Masonry drill bits, carbide-tipped



- Masonry drill bit for rotary and impact drills, milled version, carbide insert 130°, robust version
- Suitable for drilling in bricks, masonry, natural stone etc.

Diameter mm	Overall length mm	Working length mm	Sales unit	Order no.
3	60	30	1	627467000*
4	75	40	1	627468000*
5	85	50	1	627469000*
5.5	85	50	1	627470000*
6	100	60	1	627471000*
6	150	85	1	627487000*
6	200	135	1	627490000*
7	100	60	1	627473000*
8	120	80	1	627474000*
8	200	135	1	627491000*
10	120	80	1	627476000*
10	200	135	1	627492000*
12	150	85	1	627478000*
12	200	135	1	627493000*
14	150	85	1	627480000*
	<b>Masonry drill bit storage case</b> 5 pieces, in plastic storage case Ø 4 / 5 / 6 / 8 / 10 mm			627192000*
	<b>Masonry drill bit storage case</b> 8 pieces, in plastic storage case Ø 3 / 4 / 5 / 6 / 7 / 8 / 9 / 10 mm			627193000*



## Concrete drill bits, carbide-tipped, »classic« series



- Concrete drill bit for rotary and impact drills according to DIN 8039, milled angle groove, straight spiral intake, long tool life, heat-resistant, carbide insert 130°, negative chamfer, robust version
- Surface: shot blasted
- Suitable for drilling in concrete, masonry, natural stone

Diameter mm	Overall length mm	Working length mm	Sales unit	Order no.
4	85	50	1	627625000*
5	85	50	1	627626000*
5	150	90	1	627665000*
5.5	85	50	1	627627000*
6	100	55	1	627646000*
6	150	90	1	627675000*
6.5	100	55	1	627650000*
7	100	55	1	627651000*
8	120	70	1	627652000*
8	200	150	1	627679000*
9	120	70	1	627653000*
10	120	70	1	627654000*
10	200	150	1	627697000*
11	150	90	1	627655000*
12	150	90	1	627656000*
12	200	150	1	627698000*
13	150	90	1	627657000*
14	150	90	1	627658000*
14	200	150	1	627699000*
15	160	100	1	627659000*

\*Self-service packaging

Diameter mm	Overall length mm	Working length mm	Sales unit	Order no.
16	160	100	1	627661000*
18	160	100	1	627662000*
20	160	100	1	627664000*
	<b>Concrete drill bit storage case</b> 5 pieces, in plastic carry case Ø 4 / 5 / 6 / 8 / 10 mm			627180000*
	<b>Concrete drill bit storage case</b> 8 pieces, in plastic carry case Ø 3 / 4 / 5 / 6 / 7 / 8 / 9 / 10 mm			627182000*

Drill bits for concrete, carbide-tipped, »pro« series

-  High-grade, robust concrete drill bit according to DIN 8039 with carbide insert 130°, especially heat-resistant, very long tool life, with special groove for quick discharge of drilling debris
- Also suitable for light rotary hammers with a three-jaw chuck
- Suitable for drilling in granite, concrete, masonry, natural and artificial stone

Diameter mm	Overall length mm	Working length mm	Sales unit	Order no.
4	85	50	1	627224000*
5	85	50	1	627225000*
5	150	105	1	627421000*
5.5	85	50	1	627226000*
6	100	55	1	627227000*
6	150	105	1	627423000*
6.5	100	55	1	627228000*
7	100	55	1	627229000*
8	120	70	1	627230000*
8	200	135	1	627426000*
9	120	70	1	627389000*
10	120	70	1	627391000*
10	200	135	1	627427000*
11	150	90	1	627392000*
12	150	90	1	627393000*
12	200	135	1	627428000*
13	150	90	1	627394000*
14	150	90	1	627395000*
14	200	135	1	627429000*
15	150	90	1	627396000*
16	150	90	1	627399000*
18	160	95	1	627409000*
20	160	95	1	627410000*
	<b>Concrete drill bit storage case</b> 5 pieces, in plastic storage case Ø 4 / 5 / 6 / 8 / 10 mm			627181000*

Universal Drill bits, Glass Drill Bits

Universal drill bits, carbide-tipped



- Multi-purpose drill bit with straight shank, for rotary use
- With diamond-ground carbide insert and positive, aggressive cutting angle. Ideal also for use in cordless drills
- Suitable for drilling in wood, metal, plastic, brick, gypsum boards, aerated concrete, tiles, ceramic, etc.

Diameter mm	Overall length mm	Working length mm	Sales unit	Order no.
3	70	40	1	627696000*
4	85	50	1	627680000*
5	85	50	1	627681000*
5.5	85	50	1	627682000*
6	100	60	1	627683000*
6	150	90	1	627684000*
7	100	60	1	627687000*
8	120	80	1	627688000*
8	250	200	1	627689000*
10	120	80	1	627691000*
10	250	200	1	627692000*
12	150	90	1	627693000*
12	250	200	1	627694000*
14	250	200	1	627695000*
	<b>Universal drill bit storage case</b> 4 pieces in plastic storage case Ø 5 / 6 / 8 / 10 mm			627185000*

Glass drill bits, carbide tipped



- Glass drill bit with special carbide insert
- For drilling in glass, mirror glass, bottles, tiles, etc.
- Attention: set low speeds and cool sufficiently!

Diameter mm	Overall length mm	Sales unit	Order no.
4	60	1	627243000*
5	70	1	627244000*
6	75	1	627245000*
8	80	1	627246000*
10	100	1	627247000*

Diamond drill bits



- High-performance diamond drill bit for all types of tiles up to a scratch hardness of class 8. Also suitable for glass, porcelain, marble, etc.
- The drill must be cooled continuously with water.

Diameter mm	Overall length mm	Working length mm	Sales unit	Order no.
5	60	35	1	627534000*
6	60	35	1	627535000*
7	60	35	1	627536000*
8	60	35	1	627537000*
10	60	35	1	627538000*
12	60	35	1	627539000*
14	60	35	1	627544000*

\*Self-service packaging

# Wood Drill Bits

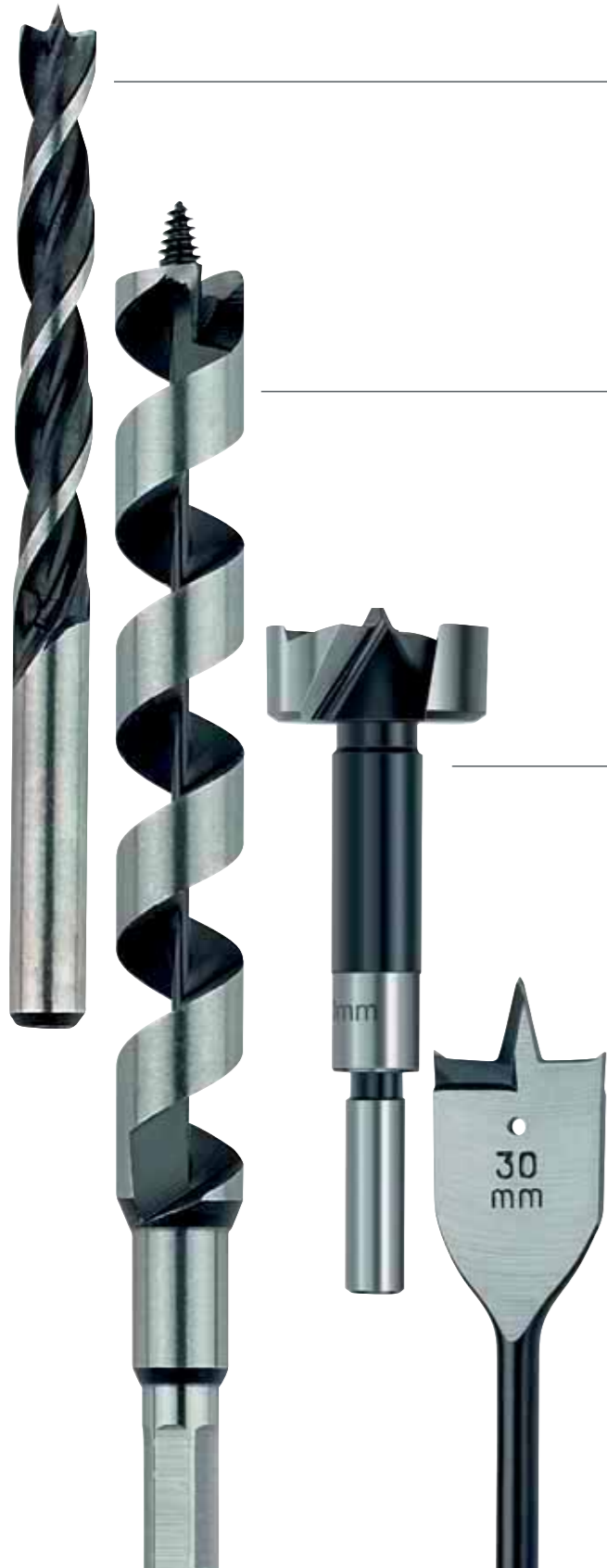

## Wood Drill Bits CV

Wood spiral drill bit made of high-grade steel, similar to DIN 7487 hardened, with centering point

**Application:**  
For drilling in hard and soft wood, plywood, chipboards, etc.

## Auger Bits

Auger bit for timber with self centering thread point and pre-cutting action, with hexagonal shaft, especially fast drilling cycle, very good material removal.

**Application:**  
Ideal for drilling deep holes in thick hard and soft wood, especially timber beams.

## Forstner Drill Bits

Similar to DIN 7483, with centering point, 2 main cutters and 2 ring cutters

**Application:**  
For use in hard and soft wood, veneered wooden boards. Suitable for drilling blind holes.

## Wood Drill Bits

Wood drill made of high-quality steel with centering point for precise drilling and 2-sided cutting for splinter-free drilling. The 1/4" (6.35 mm) hexagonal shaft fits into traditional chucks and E 6.3 holders.



**Application:**  
For fast drilling soft wood, boards, chipboards, plywood, etc.

# Wood Drill Bits

## Wood drill bits CV, with centering point



- For use in hard and soft wood, plywood, chipboards, etc.
- Wood spiral drill bit made of high-grade steel, hardened, with centering point
- Similar to DIN 7487

Diameter mm	Overall length mm	Working length mm	Sales unit	Order no.
3	61	33	1	627986000*
4	75	43	1	627987000*
5	86	52	1	627988000*
6	97	60	1	627989000*
7	109	69	1	627990000*
8	117	75	1	627991000*
9	125	80	1	627992000*
10	133	87	1	627993000*
11	142	89	1	627994000*
12	151	96	1	627995000*
13	151	96	1	627996000*
14	151	97	1	627997000*
15	151	97	1	627998000*
16	151	97	1	627999000*
18	180	120	1	627339000*
20	200	130	1	627340000*
 <b>Wood drill bit storage case</b> 5 pieces, in plastic storage case Ø 4 / 5 / 6 / 8 / 10 mm				627200000*
 <b>Wood drill bit storage case</b> 8 pieces, in plastic carry case Ø 3 / 4 / 5 / 6 / 7 / 8 / 9 / 10 mm				627202000*

## Rose bits 90°



- 5-cut rose bit made of HSS steel for acute-angled countersinks, with Allen screw, for fitting on wood spiral bits
- Can also be used as depth guide, simply invert the countersink

Diameter mm	Overall length mm	Sales unit	Order no.
3	26	1	625020000*
4	26	1	625021000*
5	26	1	625022000*
6	26	1	625023000*
8	26	1	625024000*
10	26	1	625025000*

## Countersinks



- 5-cut countersink made of HSS steel for acute-angled countersinks

Diameter mm	Overall length mm	Sales unit	Order no.
16	43	1	623521000*

\*Self-service packaging

Wood drill bits with hexagonal shank, DIN 3126



- High-quality precision tool made of the finest hardened steel
- Precision ground from one piece (not a bolted or welded 2-piece product).
- Ideal for drills equipped with quick change keyless chuck according to DIN 3126.
- Our drill's strict compliance to DIN 3126 E6.3 ensures that the chuck is not damaged.
- With centering point for precise spot-drilling.

Diameter mm	Overall length mm	Working length mm	Sales unit	Order no.
2	55	20	1	627522000*
3	65	35	1	627523000*
4	75	40	1	627524000*
5	85	50	1	627525000*
6	90	55	1	627526000*
8	90	55	1	627527000*
10	100	60	1	627528000*
	<b>Wood drill bit storage case</b> 5 pieces, with hexagonal shank (E 6.3), in plastic storage case Ø 3 / 4 / 5 / 6 / 8 mm			627111000*

Timber auger bits for wood with hexagonal shank



- Timber auger bit with self-centring thread tip and rough cutter
- Ideal for drilling deep holes in hard and soft wood, especially beams
- Auger bit Ø 6-12 mm: hexagonal shank SW 10; auger bit Ø 14-32 mm: hexagonal shank SW 11

Diameter mm	Overall length mm	Working length mm	Sales unit	Order no.
6	230	155	1	627115000*
7	230	155	1	627116000*
8	230	155	1	627124000*
10	230	155	1	627125000*
12	230	155	1	627126000*
14	230	155	1	627127000*
16	230	155	1	627128000*
18	230	155	1	627129000*
20	230	155	1	627130000*
22	230	155	1	627131000*
24	230	155	1	627132000*
26	230	155	1	627133000*
28	230	155	1	627134000*
30	230	155	1	627135000*
32	230	155	1	627136000*
8	460	385	1	627137000*
10	460	385	1	627138000*
12	460	385	1	627139000*
14	460	385	1	627140000*
16	460	385	1	627141000*
18	460	385	1	627142000*
20	460	385	1	627143000*
22	460	385	1	627144000*
24	460	385	1	627145000*
26	460	385	1	627146000*
28	460	385	1	627147000*
30	460	385	1	627148000*
32	460	385	1	627150000*

Forstner drill bits, similar to DIN 7483 G



- Forstner drill bit, similar to DIN 7483 G with centering point, 2 main cutters and 2 ring cutters
- For use in hard and soft wood, veneered wooden boards, etc.
- Suitable for drilling blind holes.

Diameter mm	Overall length mm	Shaft Ø mm	Sales unit	Order no.
10	90	8	1	627579000*
12	90	8	1	627580000*
14	90	8	1	627581000*
15	90	10	1	627582000*
16	90	10	1	627583000*
18	90	10	1	627584000*
20	90	10	1	627585000*
22	90	10	1	627586000*
24	90	10	1	627587000*
25	90	12	1	627588000*
26	90	12	1	627589000*
28	90	12	1	627590000*
30	90	12	1	627591000*
32	90	12	1	627592000*
34	90	12	1	627593000*
35	90	12	1	627594000*
36	90	12	1	627595000*
38	90	12	1	627596000*
40	90	15	1	627597000*
45	90	15	1	627598000*
50	90	15	1	627599000*

Carbide multi-spur machine bit



- Precision multi-spur machine bit, similar to DIN 7483 C with centering point, 2 sharp rough cutters and 2 main cutters made of carbide steel
- For professional use and non-splintering drilling in veneered wooden boards as well as all natural hard and soft wood types

Diameter mm	Overall length mm	Shaft Ø mm	Sales unit	Order no.
20	90	8	1	625123000*
25	90	8	1	625126000*
30	90	8	1	625128000*
35	90	10	1	625129000*
40	90	10	1	625130000*

Wood drill bits with 1/4" (6.35 mm) hexagonal shank



- Wood drill bit made of high-grade steel, with centering point for high-precision spot-drilling and two side cutters for quick and non-splintering drilling in soft wood, chipboard, plywood, light construction materials etc.
- The 1/4" (6.35 mm) hexagonal shank fits into standard chucks and E 6.3 holders.

Diameter mm	Overall length mm	Sales unit	Order no.
8	160	1	627311000*
10	160	1	627312000*
12	160	1	627313000*
13	160	1	627314000*
14	160	1	627315000*
16	160	1	627316000*
17	160	1	627347000*
18	160	1	627317000*



\*Self-service packaging

Diameter mm	Overall length mm	Sales unit	Order no.
19	160	1	627318000*
20	160	1	627319000*
22	160	1	627320000*
24	160	1	627321000*
25	160	1	627322000*
26	160	1	627323000*
28	160	1	627324000*
30	160	1	627325000*
32	160	1	627326000*
36	160	1	627327000*
38	160	1	627328000*

**Extension for wood drill bit**

Working length mm	Sales unit	Order no.
305	1	627329000*

**Drill bit assortments for metal, stone, wood**

	Order no.
 <b>Drill bit assortment</b> Stone, wood and HSS-R drill bit, 9 pieces, in plastic storage case each 3 x Ø 5 / 6 / 8 mm	627179000*
 <b>Drill bit assortment</b> Stone, wood and HSS-R drill bit, 18 pieces, in plastic storage case each 1 x Ø 3 / 4 / 5 / 6 / 8 / 10 mm	627190000

**Hole Saws**

**Multipurpose hole saws »Pionier«, carbide tipped, with M 16 female thread**



- 
- Carbide teeth supported on both sides and enlarged brazed contact areas guarantee a secure fit and a high-strength connection of material.
  - Improved vibration characteristics by means of the special curved geometry of the enlarged chip room and the clean-out slot.
  - Ideal for electricians, tile layers, sanitation installers, heater contractors, cabinet makers, kitchen studios, artisans
  - For solid wood, plywood, chipboard, plastics, acrylic glass, tiles (up to scratch hardness 6), plaster concrete blocks, aerated concrete, wood-wool boards, fibre cement, solid brick
  - Maximum cutting depth 60 mm
  - Only use in rotary mode, turn off impact. Use hole saws only with arbor and pilot drill.

Diameter mm	Order no.
25	627001000*
30	627002000*
35	627003000*
40	627004000*
50	627005000*
60	627006000*
63	627007000*
65	627008000*
68	627009000*
74	627010000*
80	627012000*
105	627013000*

\*Self-service packaging

**Arbors for multi-purpose hole saws »Pionier«**

- Comfortable quick fastener for a fast change of the centre drill, without setscrew.
- No tool loss in the event of accidentally switched-on impact mechanism: the shortened holding slots prevent impact operation on the hammer drills with SDS-plus holder, thereby not damaging the tool.
- For working with the multi-purpose hole saws »Pionier«
- Easy removal of the drilling core by unlocking the pilot drill and pulling out the drilling core from the hole saw.
- The spanner flats enable easy release of the adapter.

Shaft type	Overall length mm	Order no.
 SW11	118	627037000*
 SDS-plus	118	627038000*
 SDS-plus	220	627039000*

**Pilot drill, carbide-tipped**

	Order no.
 <b>Pilot drill</b> For work with the carbide core cutters (M16 female thread) and the universal hole saws »Pionier« (M16 female thread) in combination with one of the arbors Diameter: 8 mm Overall length: 120 mm	627040000*





**Bi-metal hole saws**

- 
- Hole saws made of bi-metal with hardened teeth made from high-alloy high-speed steel with a cobalt content of 8%, thus significantly increased tool life
  - Quicker and softer chip removal through new kind of teeth with irregular tooth shape and division; thus less vibration
  - For use in cast steel and grey cast iron, stainless steel, constructional steel, aluminium, bronze, copper, PVC, acrylic glass, wood.
  - Maximum cutting depth approx. 35 mm
  - Thread for hole saws-Ø 14-30 mm: 1/2"-20 UNF; thread for hole saws-Ø 32-152 mm: 5/8"-18 UNF
  - Use hole saws only with the corresponding arbor and pilot drill.

Diameter mm	Order no.
14	625160000*
16	625161000*
17	625162000*
19	625163000*
20	625164000*
21	625165000*
22	625166000*
24	625167000*
25	625168000*
27	625169000*
29	625170000*
30	625171000*
32	625172000*
33	625173000*
35	625174000*
37	625175000*
38	625176000*
40	625177000*
41	625178000*
43	625179000*
44	625180000*
46	625181000*
48	625182000*

Diameter mm	Order no.
51	625184000*
52	625185000*
54	625186000*
56	625187000*
57	625188000*
59	625189000*
60	625190000*
64	625191000*
65	625192000*
67	625193000*
68	625194000*
70	625195000*
73	625196000*
76	625197000*
79	625198000*
83	625199000*
86	625200000*
89	625201000*
92	625202000*
95	625203000*
98	625204000*
102	625205000*
105	625206000*
108	625207000*
111	625208000*
114	625209000*
121	625210000*
127	625211000*
140	625213000*
152	625214000*



**Arbors for bi-metal hole saws**

	Designation	Hole saw Ø	Shaft type	Order no.
	Adapter SW 9/ 1/2"-20 UNF	14 - 30 mm	SW9	625215000*
	Adapter SW 9/ 5/8"-18 UNF	32 - 152 mm	SW9	625216000*
	SDS-plus adapter/ 1/2"-20 UNF	14 - 30 mm	SDS-plus	625217000*
	SDS-plus adapter/ 5/8"-18 UNF	32 - 152 mm	SDS-plus	625218000*

**Pilot drill**

	Order no.
 <b>Pilot drill</b> For work with the HSS bi-metal hole saws in combination with one of the anchor-head holders: 625215000 to 625218000 Diameter: 6.35 mm	625220000*

**Bi-metal hole saws, assortments**

	Order no.
 <b>Bi-metal hole saw set 1, 8 pieces</b> Consisting of: Bi-metal Hole Saws Ø 22, 29, 35, 44, 51 and 68 mm Arbor for hole saw-Ø 14-30 mm (SW 9/ 1/2"-20 UNF) Arbor for hole saw-Ø 32-152 mm (SW 9/ 5/8"-18 UNF) Pilot Drill Plastic carry case	625434000*
 <b>Bi-metal hole saw set 2, 11 pieces</b> Consisting of: Bi-metal hole saw Ø 19, 22, 29, 35, 44, 51, 57, 64 and 68 mm Arbor for hole saw-Ø 14-30 mm (SW 9/ 1/2"-20 UNF) Arbor for hole saw-Ø 32-152 mm (SW 9/ 5/8"-18 UNF) Pilot Drill Plastic carry case	625435000*

**Hole saw set for wood**

	Order no.
 <b>Hole saw</b> With 8 interchangeable inserts Ø 25-68 mm, with pilot drill Ø 6 mm, shank Ø 10 mm	623531000*

**Attachments**

**Angle drilling and screw-driving attachment**

	Order no.
 <b>Angle drilling and screw-driving attachment</b> <ul style="list-style-type: none"> <li>■ Makes easy work of drilling and screw-driving in confined spaces</li> <li>■ Spindle with hexagonal recess for screwdriver bits; bit retaining bush</li> <li>■ Suitable for forward and reverse rotation</li> <li>■ Metabo quick-action coupling</li> <li>■ Gear ratio 1:1; load resistance up to 100 Nm</li> <li>■ With chuck safety bolt and hexagon nut</li> </ul> Aperture: 43 mm Spindle thread: 1/2" - 20 UNF Spindle with hexagonal recess: 1/4" (6.35 mm) Weight: 0.5 kg	631078000*

\*Self-service packaging



Pump attachments		Order no.
	<b>Pump attachment BPV 01</b> <ul style="list-style-type: none"> <li>Self-priming</li> <li>Suitable for driving units with speed up to 1,800 to 2,600 /min</li> <li>Fitted with its pin in the chuck of the driving unit</li> <li>Water temperature: max. 50° C</li> </ul> Maximum delivery rate: 1,500 l/h Maximum suction height: 2 m Maximum delivery height: 4 m Connection piece for hose: 1/2" Weight: 0.1 kg	627621000*
	<b>Pump attachment BPV 03</b> <ul style="list-style-type: none"> <li>Self-priming</li> <li>Suitable for driving units with speed up to 3,400 rpm</li> <li>Metabo quick-action coupling</li> </ul> Maximum delivery rate: 3,000 l/h Maximum suction height: 4 m Maximum delivery height: 20 m Aperture: 43 mm Connection piece for hose: R 3/4" Weight: 0.6 kg	627640000*

Hexagon nut		Order no.
	<b>Hexagon nut</b> With female thread 1/2"-20 UNF; To drive the angle attachment 631078000 or the pump attachment 627640000 on a drill with a 1/2"-20 UNF threaded spindle, but no hexagon shoulder on the spindle, requires a 19 mm AF hexagon nut (SW 19) with 1/2"-20 UNF female thread.	627601000*

Flexible shaft		Order no.
	<b>Flexible shaft</b> <ul style="list-style-type: none"> <li>Suitable for speeds of 2,000 to 5,000 rpm</li> </ul> Length: 1.2 m Driving shaft Ø: 6 mm Collet bore: 6 mm Weight: 0.8 kg	627608000*

Clamping stand		Order no.
	<b>Clamping stand</b> <ul style="list-style-type: none"> <li>For safe clamping of drills and impact drills as well as die grinders and the motor of the router when working with flexible shafts. Aperture Ø 43 mm. The clamp (627107000) serves for the secure fixing</li> </ul>	627354000*



Clamp		Order no.
	<b>Clamp</b> <ul style="list-style-type: none"> <li>For the secure fixing on a work table</li> </ul>	627107000*

### Drill Stands



Drill stand		Order no.
	<b>Drill stand 890</b> <ul style="list-style-type: none"> <li>The design of the feed mechanism enables the maximum drilling depth of 65 mm to be achieved with a swivelling motion</li> <li>Asymmetrical arrangement of the column in relation to the base plate enables the processing of larger workpieces</li> <li>Unlimited access to the controls of drill and drill stand by angled cantilever</li> <li>Adjustable depth guide</li> </ul> Inner throat: 165 mm Working stroke: 65 mm Height of column: 500 mm Column Ø: 40 mm Aperture: 43 mm Base plate: 220 x 213 mm Weight: 5.5 kg	600890000

Magnetic drill stand		Order no.
	<b>Magnetic drill stand M 100</b> <ul style="list-style-type: none"> <li>Magnet base with high holding power for safe operation</li> <li>Also suitable, when used in conjunction with the safety chain supplied, for working on vertical, sloping, or overhead surfaces</li> <li>Vertical feed driven by rack and pinion</li> <li>In order to position the tip of the drill bit that is fitted in the drill exactly over the punch mark on the material to be drilled, the upper part of the magnetic drill stand can be swivelled and moved sideways</li> <li>Power socket on the drill stand for connecting the drill directly</li> <li>Adjustable support to back up the stand against the high reacting forces that arise when drilling</li> <li>Graduated collar indicating the depth to which the hole is drilled</li> <li>Can be complemented with the drill B 32/3 to a magnetic drill unit with max. drill diameter 100 mm (with core hole drill).</li> </ul> Aperture: 65 mm Depth of feed: 260 mm Maximum height: 650 mm Magnetic force (maximum): 18,000 N Dimensions magnetic base: 110 x 220 mm Weight: 22 kg Scope of delivery: Safety chain, fastening screw G 3/4", offset screwdriver SW5 and SW8, sheet steel carry case.	627100000

### Machine Vices



	Jaw dimensions mm	Clamping width mm	Order no.
	80 x 45	86	612003000
	100 x 58	100	612001000

### Accessories for Sanding/Grinding and Polishing



		Order no.
	<b>Rubber backing pad</b> Dimensions: Ø 125 mm Clamping shaft Ø: 8 mm Sales unit: 1	623259000*
	<b>Hook and loop polishing sponge</b> For polishing paintwork Dimensions: Ø 130 mm Sales unit: 1	631222000*

\*Self-service packaging



Steel-wire Brushes

	Clamping shaft Ø mm	Outer Ø mm	Version	Order no.
	<b>Steel-wire wheel brush, stainless steel crimped</b>			
	<ul style="list-style-type: none"> <li>For light surface processing and deburring work in all metal processing</li> <li>For processing profiles, weld seams, cutting edges, gear wheels, grooves, narrow surfaces</li> <li>Edging type: crimped stainless steel wire</li> </ul>			
	6	75	Crimped	630550000*
	6	100	Crimped	630551000*
	<b>Steel-wire cup brushes, crimped steel</b>			
	<ul style="list-style-type: none"> <li>For light surface processing and deburring work in all metal processing</li> <li>For processing larger areas, weld seams, metal plates</li> </ul>			
	6	50	Crimped	626790000*
	6	75	Crimped	630552000*
	<b>Steel-wire busby-end brush, crimped steel</b>			
	<ul style="list-style-type: none"> <li>For light surface processing and deburring work in all metal processing</li> <li>For processing hard to reach spots and inner surfaces</li> </ul>			
	6	25	Crimped	630554000*

Accessories for Dust Extraction

	Order no.
 <p><b>Vacuum cleaner adapter DDE 14</b></p> <ul style="list-style-type: none"> <li>Vacuum cleaner adapter for extracting drilling dust at the hole entry point</li> <li>Safe and dust-free drilling in walls and ceilings</li> <li>By virtue of the 2-chamber system and the foam rubber gasket it stays attached to almost all (even uneven) surfaces, such as plaster, natural stone and woodchip wallpaper. Minimal drill dust residue at walls and wallpapers.</li> <li>The adapter is put on the existing suction hose. The negative pressure of the vacuum cleaner keeps the adapter to the respective subsurface.</li> </ul> Drill Ø: 4 - 14 mm	630829000*
 <p><b>Vacuum cleaner adapter DDE 72</b></p> <ul style="list-style-type: none"> <li>Vacuum cleaner adapter for extracting drilling dust at the hole entry point</li> <li>Safe and dust-free drilling in walls and ceilings</li> <li>By virtue of the 2-chamber system and the foam rubber gasket it stays attached to almost all (even uneven) surfaces, such as plaster, natural stone and woodchip wallpaper. Minimal drill dust residue at walls and wallpapers.</li> <li>The adapter is put on the existing suction hose. The negative pressure of the vacuum cleaner keeps the adapter to the respective subsurface.</li> </ul> Drill Ø: 72 mm	631343000*

Other Accessories for Drills and Impact Drills

	Order no.
 <p><b>Side handle</b> Standard version Aperture Ø: 43 mm</p>	631052000*
 <p><b>Side handle, long</b> Long type, especially suitable for working with tools with high torque; with locking screw to prevent slipping off the tool collar Aperture Ø: 43 mm</p>	631074000*
 <p><b>Reducing bush 1/2"-3/8"</b> for drills and impact drills</p>	630704000

\*Self-service packaging

Hammers: Power packs for demanding applications.

Metabo's powerful hammers are always the right choice when it comes to processing hard materials such as stone or concrete. The pneumatic impact mechanism generates high-energy impacts with only minimal extra force required from the user. The high performance hammer action is precisely mounted in a housing made of aluminium alloy, which is resistant even to the hardest mechanical loads. The enormous power combined with user-optimised ergonomics make the Metabo hammers the ideal tools for demanding applications.





**Vario Tacho Constamatic (VTC) Full-wave Electronics**  
for working at customised speeds, which remain constant under load, to suit various application materials



**Metabo S-automatic safety clutch**  
mechanical decoupling of the drive for safe working should the drill stop unexpectedly



**Metabo Marathon-motor**  
with dust protection for long service life



**Restart protection**  
prevents unintentional start-up after power supply interruption



**Metabo Quick change chuck**  
Quick change between SDS Plus hammer chuck and keyless chuck for drilling in wood and metal

**High-performance hammer action, precisely mounted in a housing made of aluminium alloy**  
long-lasting and robust



**Perfect ergonomics**  
thanks to the centre of gravity being near the hand and optimised handle contour

**UHEV 2860-2 Quick**



**Extremely powerful**  
3.4 Joule single-impact energy / 1,100 Watt



**Varied applications**  
Whether hammer drilling, chiselling or drilling without impact - the new generation of rotary hammers is consequently aimed at the requirements of professionals



**Multi hammer with two-speed gearbox**  
Two drilling speeds for faster drilling progress when drilling without impact, e.g. in porous concrete, perforated brick, wood or metal

Which hammer for which application?

Possible feature variations:



- 4 functions:**
- Hammer drilling
  - Drilling with 2 speeds
  - Chiselling



- 3 functions:**
- Hammer drilling
  - Drilling
  - Chiselling



- 2 functions:**
- Hammer drilling
  - Drilling



- 2 functions:**
- Hammer drilling
  - Chiselling



- 1 function:**
- Chiselling

Hammer drilling in concrete/stone (Ø mm)	Chiselling light	Chiselling heavy	Max. impact energy*	Battery pack voltage / rated input power	Chuck	Constant electronics	MVT anti-vibration	Integrated dust extraction

**Cordless Hammers SDS-plus**

	KHA 18 LTX	24 mm	■	-	2.2 J	18 V				
	KHA 18 LTX BL 24 Quick	24 mm	■	-	2.2 J	18 V	●	●	●	●**
	KHA 18 LTX BL 24 Quick Set ISA	24 mm	■	-	2.2 J	18 V	●	●	●	●
	KHA 36-18 LTX 32	32 mm	■■■	■	3.1 J	2 x 18 V	●		●	
	KHA 36 LTX	32 mm	■■■	■	3.1 J	36 V	●		●	

**2-speed Multi Hammers SDS-plus**

	UHE 2660-2 Quick	26 mm	■	-	2.8 J	800 W	●			
	UHEV 2860-2 Quick	28 mm	■■	■	3.4 J	1,100 W	●	●		

Application: ■ suitable ■■ very suitable ■■■ optimum Equipment: ● present

in accordance with EPTA 05/2009  
\*\* in combination with ISA 18 LTX 24 (accessory)

Hammer drilling in concrete/stone (Ø mm)	Chiselling light	Chiselling heavy	Max. single-impact energy*	Rated input power	Chuck	Constant electronics	MVT anti-vibration

**Rotary Hammers SDS-plus**

	BHE 2444	24 mm	-	-	2.3 J	800 W			
	BHE 2644	26 mm	-	-	2.3 J	800 W			

**Combination Hammers SDS-plus**

	KHE 2444	24 mm	■	-	2.3 J	800 W			
	KHE 2644	26 mm	■	-	2.3 J	800 W			
	KHE 2660 Quick	26 mm	■■	-	3.0 J	850 W	●		
	KHE 2860 Quick	28 mm	■■	-	3.2 J	880 W	●		
	KHE 3251 / KHE 3250	32 mm	■■■	■	3.1 J	800 W	● / -		●

**Combination Hammers SDS-max**

	KHE 5-40	40 mm	■■■	■■	7.5 J	1,010 W		●	●
	KHE 56	45 mm	■■	■■	8.5 J	1,300 W		●	●
	KHE 76	50 mm	■■	■■■	11.9 J	1,500 W		●	●
	KHE 96	50 mm	■	■■■	20 J	1,700 W		●	●

**Chipping Hammers SDS-max**

	MHE 5		■■■	■■	8.6 J	1,300 W		●	●
	MHE 96		■	■■■	20 J	1,600 W		●	●

18 V



Technical data	Cordless Combination Hammer KHA 18 LTX
Type of battery pack	Li-Ion / LiHD
Battery pack voltage	18 V
Max. single-impact energy (EPTA)	2.2 J
Maximum impact rate	4,000 /min
Drill-Ø concrete with hammer drills	24 mm
Drill-Ø masonry with core bits	68 mm
Drill Ø steel	13 mm
Drill-Ø soft wood	25 mm
No-load speed	0 - 1,100 /min
Bit retainer	SDS-plus
Weight (including battery pack)	2.9 kg

Scope of delivery

Order no.	600210
Hammer chuck for tools with SDS-plus shank end	■
Rubber-coated side handle	■
Drilling depth guide	■
Carrying strap	■
2 LiHD battery packs (18 V/4.0 Ah)	■
Charger ASC 30-36 V »AIR COOLED«	■
Plastic carry case	■

Equipment variants can be found in the Metabo price list and on the internet

Product advantages

- Combination hammer with 3 functions: hammer drilling, drilling and chiselling
- Variospeed (V) Electronics for working at customised speeds to suit various application materials
- Metabo S-automatic safety clutch: mechanical decoupling of the drive for safe working should the drill stop unexpectedly
- LED work light for optimum view of the drilling site
- Battery packs with capacity display for checking the charge status

System components

Accessories → 289 | Battery packs → 72

18 V



Technical data	Cordless Combination Hammer KHA 18 LTX BL 24 Quick	Cordless Combination Hammer KHA 18 LTX BL 24 Quick Set ISA
Type of battery pack	Li-Ion / LiHD	Li-Ion / LiHD
Battery pack voltage	18 V	18 V
Max. single-impact energy (EPTA)	2.2 J	2.2 J
Maximum impact rate	4,500 /min	4,500 /min
Drill-Ø concrete with hammer drills	24 mm	24 mm
Drill-Ø masonry with core bits	68 mm	68 mm
Drill Ø steel	13 mm	13 mm
Drill-Ø soft wood	25 mm	25 mm
No-load speed	0 - 1,200 /min	0 - 1,200 /min
Bit retainer	SDS-plus	SDS-plus
Weight (including battery pack)	3.7 kg	4.5 kg

Scope of delivery

Order no.	600211660	600211930 <sup>1)</sup>
Integrated dust extraction ISA 18 LTX 24		■
Replacement extraction head		■
Hammer chuck for tools with SDS-plus shank end	■	■
Keyless chuck for tools with cylindrical shank	■	■
Rubber-coated side handle	■	■
Drilling depth guide	■	■
2 LiHD battery packs (18 V/5.5 Ah)	■	
LiHD battery pack (18 V/5.5 Ah)		■
LiHD Battery pack (18 V/4.0 Ah)		■
Charger ASC 30-36 V »AIR COOLED«	■	■
Plastic carry case	■	■

Equipment variants can be found in the Metabo price list and on the internet  
<sup>1)</sup> also available in 120 V (North/Latin America)

Product advantages

- Dust-free drilling with compact dust extraction ISA 18 LTX 24 (accessory)
- Dust-free drilling with compact dust extraction ISA 18 LTX 24
- Extremely light and compact cordless hammer with integrated extraction interface
- Maximum drill performance, efficiency and service life thanks to brushless technology and high-performance hammer action
- Combination hammer with 3 functions: hammer drilling, drilling and chiselling
- Metabo VibraTech (MVT): working, also continuously, in a low-fatigue manner whilst protecting the user's health
- Metabo Quick: fast, tool-free chuck for working with SDS-plus and straight shank drill bits
- Vario Constamatic (VTC) Electronics for drilling jobs in materials requiring customised speeds, which remain almost constant under load
- Double safe thanks to electronic and mechanical safety shutdown when the drill stops unexpectedly
- LED work light for optimum view of the drilling site

System components

Accessories → 289, 306 | Battery packs → 72

01  
02  
03  
04  
05  
06  
07  
08  
09  
10  
11  
12  
13  
14  
15

2x 18 V  
36 V



Technical data	Cordless Combination Hammer KHA 36-18 LTX 32	Cordless Combination Hammer KHA 36 LTX
Type of battery pack	Li-Ion / LiHD	Li-Ion / LiHD
Battery pack voltage	18 V	36 V
Max. single-impact energy (EPTA)	3.1 J	3.1 J
Maximum impact rate	4,500 /min	4,500 /min
Drill-Ø concrete with hammer drills	32 mm	32 mm
Drill-Ø masonry with core bits	68 mm	68 mm
Drill Ø steel	13 mm	13 mm
Drill-Ø soft wood	30 mm	30 mm
No-load speed	0 - 1,100 /min	0 - 1,100 /min
Bit retainer	SDS-plus	SDS-plus
Weight (including battery pack)	5.8 kg	4.9 kg

Scope of delivery

Order no.	600796	600795 <sup>1)</sup>
Hammer chuck for tools with SDS-plus shank end	■	■
Keyless chuck for tools with a straight shank	■	■
Metabo VibraTech (MVT) side handle	■	■
Drilling depth guide	■	■
4 Li-Power Battery packs (18 V/8.0 Ah)	■	■
2 Li-Power battery packs (36 V/5.2 Ah)	■	■
2 Quick chargers ASC Ultra »AIR COOLED«	■	■
»AIR COOLED« quick charger ASC Ultra		■
Plastic carry case		■
MetaLoc case	■	

Equipment variants can be found in the Metabo price list and on the internet  
<sup>1)</sup> also available in 120 V (North/Latin America)

Product advantages

- 100% compatibility with the 18 Volt class: powerful 36 Volt operation with two 18 Volt battery packs from Metabo
- Combination hammer with 3 functions: hammer drilling, drilling and chiselling
- Metabo VibraTech (MVT): working, also continuously, in a low-fatigue manner whilst protecting the user's health
- Ergonomic housing shape for chiselling tasks without side handle
- Metabo Quick: fast, tool-free chuck for working with SDS-plus and straight shank drill bits
- Variospeed (V) Electronics for working at customised speeds to suit various application materials
- Metabo S-automatic safety clutch: mechanical decoupling of the drive for safe working should the drill stop unexpectedly
- Battery packs with capacity display for checking the charge status

System components

Accessories → 289 | Battery packs → 72



Technical data	Multi Hammer UHE 2660-2 Quick	Multi Hammer UHEV 2860-2 Quick
Max. single-impact energy (EPTA)	2.8 J	3.4 J
Maximum impact rate	4,200 /min	4,500 /min
Rated input power	800 W	1,100 W
Drill-Ø concrete with hammer drills	26 mm	28 mm
Drill-Ø masonry with core bits	68 mm	68 mm
Drill Ø steel	13 mm/6 mm	13 mm/6 mm
Drill-Ø soft wood	32 mm/28 mm	35 mm/30 mm
No-load speed	0 - 1,050 / 0 - 2,500 /min	0 - 900 / 0 - 2,100 /min
Revolutions at rated load	790/1,860 /min	900/2,100 /min
Bit retainer	SDS-plus	SDS-plus
Collar diameter	50 mm	50 mm
Weight (without mains cable)	3.1 kg	3.3 kg
Cable length	4 m	4 m

Scope of delivery

Order no.	600697	600713 <sup>1) 2)</sup>
Hammer chuck for tools with SDS-plus shank end	■	■
Keyless chuck for tools with cylindrical shank	■	■
Rubber-coated side handle	■	■
Drilling depth guide	■	■
Plastic carry case	■	■

<sup>1)</sup> also available in 120 V (North/Latin America)  
<sup>2)</sup> also available in 110 V (UK)

Product advantages

- Variospeed (V) Electronics for working at customised speeds to suit various application materials
- Vario-Tacho-Constamatic (VTC)-Full Wave Electronics for work with materials requiring customised speeds, which remain constant under load
- Restart protection: prevents unintentional start-up after power supply interruption
- Multi hammer with 4 functions: hammer drilling, drilling without impact in two speeds and chiselling
- Metabo Quick: quick change between SDS Plus hammer chuck and keyless chuck for drilling in wood and metal
- Thumbwheel for speed preselection and impact rate
- Two-speed gear unit: two drilling speeds for effective drilling in wood and metal
- Metabo Marathon-motor with dust protection for long service life
- High-performance hammer action, precisely mounted in a housing made of aluminium alloy: long-lasting and robust
- Perfect ergonomics thanks to the centre of gravity being near the hand and optimised handle contour
- Bottom switch protected against damage and dust
- Metabo S-automatic safety clutch: mechanical decoupling of the drive for safe working should the drill stop unexpectedly
- Lockable switch for comfortable working in continuous operation
- Cable-protecting ball joint for optimal freedom of motion when working

System components

Accessories → 289



Technical data	Rotary Hammer BHE 2444	Rotary Hammer BHE 2644
Max. single-impact energy (EPTA)	2.3 J	2.3 J
Maximum impact rate	5,400 /min	5,400 /min
Rated input power	800 W	800 W
Drill-Ø concrete with hammer drills	24 mm	26 mm
Drill-Ø masonry with core bits	68 mm	68 mm
Drill Ø steel	13 mm	13 mm
Drill-Ø soft wood	30 mm	30 mm
No-load speed	0 - 1,230 /min	0 - 1,150 /min
Revolutions at rated load	880 /min	960 /min
Bit retainer	SDS-plus	SDS-plus
Collar diameter	43 mm	43 mm
Weight (without mains cable)	2.3 kg	2.7 kg
Cable length	4 m	4 m

Scope of delivery

Order no.	606153	606156
Hammer chuck for tools with SDS-plus shank end	■	■
Side handle	■	■
Drilling depth guide	■	■
Plastic carry case	■	■

Product advantages

- Electronic soft start for precise spot-drilling
- High-performance hammer action, precisely mounted in a housing made of aluminium alloy: long-lasting and robust
- Handle with non-slip soft-grip surface
- Rotary hammer with 2 functions: hammer drilling and drilling
- Variospeed (V) Electronics for working at customised speeds to suit various application materials
- Metabo S-automatic safety clutch: mechanical decoupling of the drive for safe working should the drill stop unexpectedly

System components

Accessories → 289



Technical data	Combination Hammer KHE 2444	Combination Hammer KHE 2644
Max. single-impact energy (EPTA)	2.3 J	2.3 J
Maximum impact rate	5,400 /min	5,400 /min
Rated input power	800 W	800 W
Drill-Ø concrete with hammer drills	24 mm	26 mm
Drill-Ø masonry with core bits	68 mm	68 mm
Drill Ø steel	13 mm	13 mm
Drill-Ø soft wood	30 mm	30 mm
No-load speed	0 - 1,230 /min	0 - 1,150 /min
Revolutions at rated load	880 /min	960 /min
Bit retainer	SDS-plus	SDS-plus
Collar diameter	43 mm	43 mm
Weight (without mains cable)	2.4 kg	2.9 kg
Cable length	4 m	4 m

Scope of delivery

Order no.	606154 <sup>1)</sup>	606157 <sup>2)</sup>
Hammer chuck for tools with SDS-plus shank end	■	■
Side handle	■	■
Drilling depth guide	■	■
Plastic carry case	■	■

<sup>1)</sup> also available in 120 V (North/Latin America)  
<sup>2)</sup> also available in 110 V (UK)

Product advantages

- Electronic soft start for precise spot-drilling
- High-performance hammer action, precisely mounted in a housing made of aluminium alloy: long-lasting and robust
- Combination hammer with 3 functions: hammer drilling, drilling and chiselling
- Variospeed (V) Electronics for working at customised speeds to suit various application materials
- Metabo S-automatic safety clutch: mechanical decoupling of the drive for safe working should the drill stop unexpectedly
- Lockable switch for comfortable working in continuous operation

System components

Accessories → 289

01  
02  
03  
04  
05  
06  
07  
08  
09  
10  
11  
12  
13  
14  
15

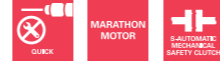

Technical data	Combination Hammer KHE 2660 Quick	Combination Hammer KHE 2860 Quick
Max. single-impact energy (EPTA)	3 J	3.2 J
Maximum impact rate	4,300 /min	4,400 /min
Rated input power	850 W	880 W
Drill-Ø concrete with hammer drills	26 mm	28 mm
Drill-Ø masonry with core bits	68 mm	68 mm
Drill Ø steel	13 mm	13 mm
Drill-Ø soft wood	32 mm	32 mm
No-load speed	0 - 1,100 /min	0 - 1,150 /min
Revolutions at rated load	830 /min	870 /min
Bit retainer	SDS-plus	SDS-plus
Collar diameter	50 mm	50 mm
Weight (without mains cable)	3.1 kg	3.1 kg
Cable length	4 m	4 m

Scope of delivery

Order no.	600663 <sup>2)</sup>	600878 <sup>1)</sup>
Hammer chuck for tools with SDS-plus shank end	■	■
Keyless chuck for tools with a straight shank	■	■
Rubber-coated side handle	■	■
Drilling depth guide	■	■
Plastic carry case	■	■

<sup>1)</sup> also available in 120 V (North/Latin America)

<sup>2)</sup> also available in 110 V (UK)

Product advantages

- Combination hammer with 3 functions: hammer drilling, drilling and chiselling
- Metabo Quick: quick change between SDS Plus hammer chuck and keyless chuck for drilling in wood and metal
- Perfect ergonomics thanks to the centre of gravity being near the hand and optimised handle contour
- Bottom switch protected against damage and dust
- Variospeed (V) Electronics for working at customised speeds to suit various application materials
- Metabo Marathon-motor with dust protection for long service life
- High-performance hammer action, precisely mounted in a housing made of aluminium alloy: long-lasting and robust
- Metabo S-automatic safety clutch: mechanical decoupling of the drive for safe working should the drill stop unexpectedly
- Lockable switch for comfortable working in continuous operation
- Cable-protecting ball joint for optimal freedom of motion when working

System components

Accessories → 289



Technical data	Combination Hammer KHE 3250	Combination Hammer KHE 3251
Max. single-impact energy (EPTA)	3.1 J	3.1 J
Maximum impact rate	4,470 /min	4,470 /min
Rated input power	800 W	800 W
Drill-Ø concrete with hammer drills	32 mm	32 mm
Drill-Ø masonry with core bits	82 mm	82 mm
Drill Ø steel	13 mm	13 mm
Drill-Ø soft wood	35 mm	35 mm
No-load speed	0 - 1,150 /min	0 - 1,150 /min
Revolutions at rated load	920 /min	920 /min
Bit retainer	SDS-plus	SDS-plus
Collar diameter	50 mm	50 mm
Weight (without mains cable)	3.4 kg	3.6 kg
Cable length	4 m	4 m

Scope of delivery

Order no.	600637 <sup>1)</sup>	600659 <sup>1) 2)</sup>
Hammer chuck for tools with SDS-plus shank end	■	■
Keyless chuck for tools with a straight shank	■	■
Metabo VibraTech (MVT) side handle	■	■
Drilling depth guide	■	■
Plastic carry case	■	■

<sup>1)</sup> also available in 120 V (North/Latin America)

<sup>2)</sup> also available in 110 V (UK)

Product advantages

- Metabo Quick: quick change between SDS Plus hammer chuck and keyless chuck for drilling in wood and metal
- Combination hammer with 3 functions: hammer drilling, drilling and chiselling
- Metabo VibraTech (MVT): integrated damping system and side handle to reduce vibrations in order to protect the user's health
- Ergonomic housing shape for chiselling tasks without side handle
- Variospeed (V) Electronics for working at customised speeds to suit various application materials
- Metabo Marathon-motor with dust protection for long service life
- High-performance hammer action, precisely mounted in a housing made of aluminium alloy: long-lasting and robust
- Metabo S-automatic safety clutch: mechanical decoupling of the drive for safe working should the drill stop unexpectedly
- Cable-protecting ball joint for optimal freedom of motion when working

System components

Accessories → 289



Technical data	Combination Hammer KHE 5-40	Combination Hammer KHE 56
Max. single-impact energy (EPTA)	7.5 J	8.5 J
Maximum impact rate	3,200 /min	2,840 /min
Rated input power	1,010 W	1,300 W
Drill-Ø concrete with hammer drills	40 mm	45 mm
Drill-Ø concrete with core bits	90 mm	100 mm
No-load speed	200 - 350 /min	0 - 300 /min
Bit retainer	SDS-max	SDS-max
Collar diameter	60 mm	66 mm
Weight (without mains cable)	6.2 kg	6.7 kg
Cable length	4 m	6 m

Scope of delivery

Order no.	600687 <sup>1) 2)</sup>	600340 <sup>1) 2)</sup>
Metabo VibraTech (MVT) side handle	■	■
Drilling depth guide	■	■
Lubricant for tool shank end	■	■
Duster	■	■
Plastic carry case	■	■

<sup>1)</sup> also available in 120 V (North/Latin America)  
<sup>2)</sup> also available in 110 V (UK)

Product advantages

- Metabo VibraTech (MVT): integrated damping system and side handle to reduce vibrations in order to protect the user's health
- Thumbwheel for speed preselection and impact rate
- Wear Indication for Carbon Brush
- Metabo VibraTech (MVT): integrated damping system to reduce vibrations in order to protect the user's health
- Optional 30% impact reduction setting for working with more pliable materials
- Service display, e.g. to indicate when the carbon brush needs to be replaced, and an LED indicating mains voltage
- Lockable switch for comfortable working in continuous operation
- Combination hammer with 2 functions: hammer drilling and chiselling
- Vario-Tacho-Constamatic (VTC)-Full Wave Electronics for work with materials requiring customised speeds, which remain constant under load
- Electronic soft start for precise spot-drilling
- Optimum heat dissipation and low weight thanks to die cast magnesium gear housing
- Metabo S-automatic safety clutch: mechanical decoupling of the drive for safe working should the drill stop unexpectedly

System components

Accessories → 296



Technical data	Combination Hammer KHE 76	Combination Hammer KHE 96
Max. single-impact energy (EPTA)	11.9 J	20 J
Maximum impact rate	2,735 /min	1,950 /min
Rated input power	1,500 W	1,700 W
Drill-Ø concrete with hammer drills	50 mm	50 mm
Drill-Ø concrete with core bits	150 mm	150 mm
No-load speed	0 - 300 /min	125 - 250 /min
Bit retainer	SDS-max	SDS-max
Collar diameter	66 mm	73 mm
Weight (without mains cable)	8.4 kg	11.8 kg
Cable length	6 m	6 m

Scope of delivery

Order no.	600341 <sup>1) 2)</sup>	600596 <sup>1) 2)</sup>
Metabo VibraTech (MVT) side handle	■	■
Lubricant for tool shank end	■	■
Duster	■	■
Plastic carry case	■	■

<sup>1)</sup> also available in 120 V (North/Latin America)  
<sup>2)</sup> also available in 110 V (UK)

Product advantages

- Metabo VibraTech (MVT) vibration absorber: the spring-mounted anti-vibration mass reduces vibrations by more than 30%
- Optional 30% impact reduction setting for working with more pliable materials
- Optimum heat dissipation and low weight thanks to die cast magnesium gear housing
- Service display, e.g. to indicate when the carbon brush needs to be replaced, and an LED indicating mains voltage
- Metabo VibraTech (MVT) side handle for vibration damping to protect the user's health
- Metabo VibraTech (MVT): integrated damping system to reduce vibrations in order to protect the user's health
- Thumbwheel for speed preselection and impact rate
- Wear Indication for Carbon Brush
- Combination hammer with 2 functions: hammer drilling and chiselling
- Vario-Tacho-Constamatic (VTC)-Full Wave Electronics for work with materials requiring customised speeds, which remain constant under load
- Electronic soft start for precise spot-drilling
- Metabo S-automatic safety clutch: mechanical decoupling of the drive for safe working should the drill stop unexpectedly
- Lockable switch for comfortable working in continuous operation

System components

Accessories → 296





Technical data	Chipping Hammer MHE 5	Chipping Hammer MHE 96
Max. single-impact energy (EPTA)	8.6 J	20 J
Maximum impact rate	3,000 /min	1,950 /min
Rated input power	1,300 W	1,600 W
Bit retainer	SDS-max	SDS-max
Weight (without mains cable)	6.6 kg	11 kg
Cable length	4 m	6 m

Scope of delivery	600688 <sup>1) 2)</sup>	600396 <sup>1) 2)</sup>
Order no.		
Front handle	■	■
Lubricant for tool shank end	■	■
Duster	■	■
Plastic carry case	■	■

<sup>1)</sup> also available in 120 V (North/Latin America)  
<sup>2)</sup> also available in 110 V (UK)

- Product advantages**
- Optimum heat dissipation and low weight thanks to die cast magnesium gear housing
  - Service display, e.g. to indicate when the carbon brush needs to be replaced, and an LED indicating mains voltage
  - Long design for an upright, back-friendly working position when performing ground work
  - Robust die cast aluminium gear housing for optimum heat dissipation and long service life
  - Wear Indication for Carbon Brush
  - Metabo VibraTech (MVT): integrated damping system to reduce vibrations in order to protect the user's health
  - Vario-Tacho-Constamatic (VTC)-Full Wave Electronics for work with materials requiring customised speeds, which remain constant under load
  - Thumbwheel for preselection of impact rate
  - Electronic soft start for smooth start-up
  - Lockable switch for comfortable chiselling in continuous operation
  - The adjustable front handle can be rotated 360° and the angle adjusted for an optimum working position

System components

Accessories → 300

## SDS-MAX/SDS-PLUS: Quality classes

Metabo offers you three quality classes for drill bits and chisels: From simple applications, where a solid, robust quality drill bit is required, and applications with high demands, to extreme applications with highest demands for the tool used. This means: We have the right drill bit or chisel for you for any application.

### »Classic«

Solid, robust and reliable. These characteristics perfectly describe »Classic« tools. »Classic« hammer drill bits have a carbide tip and a good tool life. The chisels of this class are characterised by high material quality and good material removal. They always provide good service for all standard applications.

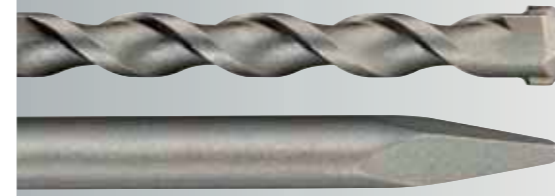

### »Professional« / »Pro 4«

»Professional«, is, when it comes to drillers, in short "Pro4". Drill bits and chisels in this class are of particularly high quality and have a long service life. Special hardened steel and special surface handling guarantee long tool life and fast progress when drilling and chiselling. For users with high demands, who want more than the usual.



### »Professional Premium« / »Pro 4 Premium«

This is the pinnacle of accessories. It offers the maximum of features a tool can offer. These products have innovative features that achieve excellent work results even for demanding applications. »Professional Premium« chisels are self-sharpening for maximum breaking performance and longest tool life. »Pro 4 Premium« drill bits with 4 cutting edges in 4x90° geometry do not stop even when hitting reinforced concrete. For users with high demands for tools and machines.



01  
02  
03  
04  
05  
06  
07  
08  
09  
10  
11  
12  
13  
14

# SDS-plus Hammer Drill Bits

## SDS-plus »Pro 4«: progress extremely fast

The special cutting geometry on the chisel-shaped bit head made of high quality carbide ensures quick penetration even into the toughest concrete and in granite.

- **Highest drill speed** thanks to reduction in friction and improved impact transmission
- **2-spiral helix with its large geometry with reinforced core (KVS).** The narrower cutting width geometry at the front edge and the reinforced relief and core at the rear additionally reduce friction whilst ensuring high resistance to breakage at the same time
- The **special cutting geometry** on the chisel-shaped drill head ensures deep penetration in hardest concrete and granite
- **Stable and durable centering point** for high-precision spot-drilling, no running across smooth surfaces
- **Power breakers** cause micro tears in the material for a noticeable quicker drill progress



## SDS-plus »Pro 4 Premium«: break-proof and durable

The combination of an intelligent, innovative geometry with uncompromising quality right down to the last detail can be seen by the high level of durability, precise drilled holes and the extraordinarily quiet operation even under the toughest of conditions.

- Innovative, unique, full carbide cutting geometry in **optimum 4x90° symmetry** prevents catching when you come across reinforcements and ensures round holes
- **Power breakers** cause micro tears in the material for a noticeable quicker drill progress
- **up to Ø 10 mm: full carbide head** for even higher drill speed and longer service life
- **Ø 12-16 mm: single-piece carbide element** centering point for simple, accurate drilling





- **Ø from 18 mm: three-piece carbide element** centering point and wear marking on both sides of the main plate for simple, precise piloting and the evaluation of measured dowel holes
- **Low-vibration drilling with 4-spiral helix.** 2 large volume helixes remove the bore dust quickly and reliably from the drill hole, two reinforced spirals ensure additional safety and stability.



## Carbide-tipped hammer drill bits, SDS plus »Classic«, 2 cutting edges



- SDS-plus drill bit with high-quality carbide drill tip
- Dynamic, chisel-shaped bit head
- Large-volume S-spiral geometry ensures quick drill dust removal
- Good drilling output with good tool life
- For use in concrete, masonry, natural stone

Diameter mm	Working length mm	Overall length mm	Sales unit	Order no.
5	50	110	1	626172000*
5	100	160	1	626173000*
6	50	110	1	626174000*
6	100	160	1	626175000*
6	150	210	1	626176000*
6	200	260	1	626177000*
6	250	310	1	626178000*
7	50	110	1	626179000*
7	100	160	1	626180000*
8	50	110	1	626181000*
8	100	160	1	626182000*
8	150	210	1	626183000*
8	200	260	1	626184000*
10	50	110	1	626185000*
10	100	160	1	626186000*
10	150	210	1	626187000*
10	200	260	1	626188000*
10	250	310	1	626189000*
10	400	450	1	626190000*
12	100	160	1	626191000*
12	150	210	1	626192000*
12	200	260	1	626193000*
12	250	310	1	626194000*
12	400	450	1	626195000*
14	100	160	1	626196000*
14	150	210	1	626197000*
14	250	310	1	626198000*
14	400	450	1	626199000*
 <b>SDS-plus Classic drill bit set, 5 pieces</b> in plastic storage case Ø 5, 6, 6, 8, 10 mm, L=160 mm				626243000*
 <b>SDS-plus Classic drill bit set, 7 pieces</b> in metal case Ø 5, 6, 6, 8, 10 mm, L=160 mm / Ø 6, 8, 10, 12 mm, L=160				626244000*

## Carbide-tipped hammer drill bit, SDS-plus »Pro 4«, 2 cutting edges









- Highest drill speed thanks to reduction in friction and improved impact transmission thanks to the special cutting geometry on the chisel-shaped drill head.
- Stable and durable centering point for high-precision spot-drilling
- Power breakers cause micro tears in the material for a noticeable quicker drill progress
- The probability of snagging on concrete reinforcements is significantly reduced thanks to enlarged armouring phases.
- The 2-spiral helix with its helical geometry with reinforced core ensures quick delivery of bore dust and maximum breakage resistance
- For use in concrete, masonry, natural stone, granite

Diameter mm	Working length mm	Overall length mm	Sales unit	Order no.
4	50	110	1	631780000*
5	50	110	1	631820000*
5	100	160	1	631821000*
5	150	210	1	631864000*
5	200	260	1	625256000*
5	250	310	1	625257000*
5	310	360	1	625258000*

\*Self-service packaging

Diameter mm	Working length mm	Overall length mm	Sales unit	Order no.
5	400	460	1	625259000*
5.5	50	110	1	631822000*
5.5	100	160	1	631823000*
5.5	200	260	1	625249000*
5.5	250	310	1	625250000*
6	50	110	1	631824000*
6	100	160	1	631825000*
6	150	210	1	631826000*
6	200	260	1	631866000*
6.5	50	110	1	631827000*
6.5	100	160	1	631828000*
6.5	150	210	1	631879000*
6.5	200	260	1	631876000*
6.5	250	310	1	631868000*
6.5	350	400	1	631785000*
7	50	110	1	631829000*
7	100	160	1	631830000*
7	150	210	1	631831000*
8	50	110	1	631832000*
8	100	160	1	631833000*
8	150	210	1	631834000*
8	200	260	1	631835000*
8	250	310	1	625229000*
8	340	400	1	625251000*
8	400	460	1	631788000*
8	540	600	1	631789000*
9	150	210	1	631836000*
9.5	250	310	1	625253000*
10	50	110	1	631837000*
10	100	160	1	631838000*
10	150	210	1	631839000*
10	200	260	1	631840000*
10	250	310	1	631841000*
10	390	450	1	630519000*
10	540	600	1	631793000*
10	940	1,000	1	631794000*
11	110	160	1	631842000*
11	210	260	1	631843000*
12	110	160	1	631844000*
12	160	210	1	631845000*
12	210	260	1	631846000*
12	310	360	1	625254000*
12	400	450	1	630526000*
12	550	600	1	630527000*
12	950	1,000	1	631797000*
13	110	160	1	631847000*
13	210	260	1	631848000*
14	110	160	1	631849000*
14	160	210	1	631850000*
14	210	260	1	631851000*
14	260	310	1	631852000*
14	400	450	1	631801000*
14	550	600	1	630528000*
14	950	1,000	1	631802000*
15	210	260	1	631853000*
15	410	450	1	631803000*
16	110	160	1	631854000*
16	160	210	1	631855000*
16	210	260	1	625255000*
16	260	310	1	631856000*
16	400	450	1	630531000*
16	550	600	1	630532000*
16	750	800	1	631804000*
16	950	1,000	1	631805000*

Diameter mm	Working length mm	Overall length mm	Sales unit	Order no.
18	150	200	1	630533000*
18	250	300	1	631806000*
18	400	450	1	630589000*
18	550	600	1	631807000*
18	950	1,000	1	631808000*
20	150	200	1	630536000*
20	250	300	1	630590000*
20	400	450	1	630537000*
20	550	600	1	631809000*
20	950	1,000	1	631810000*
22	200	250	1	630538000*
22	400	450	1	630539000*
22	550	600	1	631811000*
22	950	1,000	1	631812000*
24	200	250	1	630540000*
24	400	450	1	630541000*
25	200	250	1	631814000*
25	400	450	1	630549000*
25	550	600	1	631815000*
25	950	1,000	1	631816000*
26	200	250	1	630542000*
26	400	450	1	630548000*
4	50	110	10	625230000
5	50	110	10	625231000
5	100	160	10	625232000
6	50	110	10	625233000
6	100	160	10	625234000
6	150	210	10	625235000
8	50	110	10	625236000
8	100	160	10	625237000
8	150	210	10	625238000
10	50	110	10	625239000
10	100	160	10	625240000
10	150	210	10	625241000
10	200	260	10	625242000
12	110	160	10	625243000
12	160	210	10	625244000
12	210	260	10	625245000
14	110	160	10	625246000
14	160	210	10	625247000
14	210	260	10	625248000
	<b>SDS-plus Pro 4 drill bit set, 4 pieces</b> in plastic storage case Ø 5, 6 mm, L = 50/110 mm; Ø 8.10 mm, L = 110/160 mm			630580000*
	<b>SDS-plus Pro 4 drill bit set, 5 pieces</b> in plastic storage case Ø 5, 6, 6, 8, 10 mm, L = 160 mm			630581000*
	<b>SDS-plus Pro 4 drill bit set, 7 pieces</b> in metal case Ø 5, 6, 6, 8, 8, 10, 12 mm, L = 110/160 mm			630584000*
	<b>SDS-plus drill bit / chisel set, 5 pieces</b> comprises each 1 hammer drill bit Ø 6, 8, 10 mm, 1 pointed chisel and 1 flat chisel			630477000*
	<b>SDS-plus Pro 4 drill bits / chisel roll-up case, 10 pieces, set</b> in roll-up case 2 x each: Ø 6 x 160; Ø 8 x 160; je 1 x: Ø 8 x 210; Ø 10 x 160; Ø 10 x 210; Ø 12 x 210 mm 1 x pointed chisel (L 200 mm), 1 x flat chisel (20 x 200 mm), incl. 1 x multi-tool			631690000
	<b>SDS-plus Pro 4 drill bit set, 8 pieces</b> in roll-up case 2 x each: Ø 6 x 160; Ø 8 x 160; je 1 x: Ø 8 x 210; Ø 10 x 160; Ø 10 x 210; Ø 12 x 210 mm			631715000

\*Self-service packaging

Carbide-tipped hammer drill bits (ice drill) with SDS-plus shank end, 2 cutting edges



- For use in ice and snow
- Suitable for easy installation of slalom posts.
- Special helix for ice and snow.

Diameter mm	Working length mm	Overall length mm	Sales unit	Order no.
32	400	450	1	630579000*

Carbide-tipped hammer drill bits, SDS-plus »Pro 4 Premium«, 4 cutting edges



NEW

- Intelligent geometry with its uncompromised quality of detail ensures a long service life, precise drill holes and maximum quiet running - even on the toughest loads.
- Highest level of safety thanks to the optimum symmetrical head geometry with 4 full carbide cutters, which do not catch when encountering reinforcing.
- Up to Ø 10 mm: with innovative, welded full carbide head for maximum tool life and larger dust outputs for highest drill speed
- Power breakers cause micro tears in the material for a noticeable quicker drill progress
- Low-vibration drilling with 4-spiral helix. 2 large volume helixes remove the bore dust quickly and reliably from the drill hole, two reinforced spirals ensure additional safety and stability.
- Extremely resistant to breakage thanks to high-grade special steel
- Very long tool life for up to 50% more dowel-compatible circular bores
- For professional use in the hardest natural stones, concrete, masonry.

Diameter mm	Working length mm	Overall length mm	Sales unit	Order no.
5	50	115	1	626200000*
5	100	165	1	626201000*
5	150	215	1	626241000*
5.5	50	115	1	626202000*
5.5	100	165	1	626203000*
6	50	115	1	626204000*
6	100	165	1	626205000*
6	150	215	1	626206000*
6	200	265	1	626207000*
6	250	315	1	626208000*
6.5	100	165	1	626209000*
6.5	150	215	1	626210000*
6.5	200	265	1	626211000*
6.5	250	315	1	626212000*
7	50	115	1	626213000*
7	100	165	1	626214000*
8	50	115	1	626215000*
8	100	165	1	626216000*
8	150	215	1	626217000*
8	200	265	1	626218000*
8	250	315	1	626237000*
8	400	465	1	626240000*
10	50	115	1	626219000*
10	100	165	1	626220000*
10	150	215	1	626221000*
10	200	265	1	626222000*
10	250	315	1	626223000*
10	390	455	1	626224000*
10	540	605	1	626117000*
12	110	160	1	626225000*
12	160	210	1	626226000*
12	210	260	1	626227000*
12	260	310	1	626228000*
12	400	450	1	626229000*
12	550	600	1	626118000*
13	260	310	1	626124000*
14	110	160	1	626230000*

Diameter mm	Working length mm	Overall length mm	Sales unit	Order no.
14	160	210	1	626231000*
14	210	260	1	626119000*
14	260	310	1	626232000*
14	400	450	1	626233000*
14	550	600	1	626120000*
15	160	210	1	626248000*
15	210	260	1	626121000*
16	110	160	1	626234000*
16	160	210	1	626235000*
16	210	260	1	626238000*
16	260	310	1	626236000*
16	400	450	1	626239000*
18	200	250	1	631703000*
18	400	450	1	631704000*
20	200	250	1	631705000*
20	400	450	1	631706000*
22	200	250	1	626122000*
22	400	450	1	631707000*
24	200	250	1	631708000*
24	400	450	1	631709000*
25	200	250	1	626123000*
25	400	450	1	631710000*
28	400	450	1	631711000*
30	400	450	1	631712000*
32	400	450	1	631713000*
6	100	165	5	628231000*
5	50	115	10	626268000*
5	110	165	10	626269000*
6	50	115	10	626270000*
6	110	165	10	626271000*
6	160	215	10	626272000*
8	110	165	10	626273000*
8	160	215	10	626274000*
10	110	165	10	626275000*
10	160	215	10	626276000*
12	110	160	10	626277000*
12	160	210	10	626278000*
12	190	260	10	626249000*



**SDS-plus Pro 4 Premium drill bit set, 7 pieces**  
in robust plastic storage case  
Ø 5 x 115 mm; 6 x 115 mm; 8 x 115 mm; 6 x 165 mm; 8 x 165 mm; 10 x 165 mm; 12 x 160 mm



**SDS-plus Pro 4 Premium drill bit set, 7 pieces**  
Ø 5 x 160 mm; 6 x 210 mm; 6.5 x 210 mm; 6.5 x 260 mm; 8 x 260 mm; 10 x 260 mm; 12 x 260 mm

Side handles



**Metabo VibraTech (MVT) side handle**  
■ Suitable for UHE 28 Plus, KHE 28 Plus

\*Self-service packaging

# SDS-max »Pro 4«: Extremely fast in concrete and armoured concrete



- **Unrivalled destructive force** thanks to extremely robust and aggressive solid carbide S-blade
- Short head with **large-volume dust channels** for smooth transport of the drill dust, minimum generation of heat for constantly **long service life**



- Inclined auxiliary cutting edges for aggressive drilling progress with **highest drilling speed**

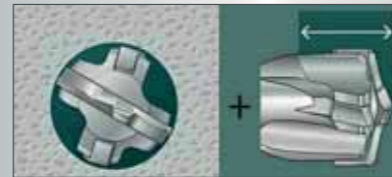

- **Drill-active centering point** for precise spot-drilling and optimum guidance when drilling in concrete and armoured concrete
- **Innovative wear indication** as indicator for dimensional conformance and precise drilling hole diameter
- **Vibration Control** – ideal for the hardest applications on the construction site

## Carbide-tipped hammer drill bits, SDS-max »Pro 4«, 2 cutting edges



- The slim, chisel-shaped bit head enables fast penetration into the selected material.
- Short spiral inlets and large boring dust grooves in the optimised double delivery helix ensure quick boring dust discharge.
- The continuous core reinforcement ensures stability and durability. It enables maximum energy transmission from rotary hammer to drill tip.
- For use in concrete, masonry, natural stone

Diameter mm	Working length mm	Overall length mm	Sales unit	Order no.
12	200	340	1	623310000*
12	400	540	1	623311000*
12	600	740	1	623312000*
14	200	340	1	623313000*
14	400	540	1	623314000*
15	200	340	1	623315000*
15	400	540	1	623316000*

## Carbide-tipped hammer drill bits, SDS-max »Pro 4«, 4 cutting edges



- Unrivalled destructive force: Extremely robust and aggressive solid carbide S-blade
- Constant high lifetime: Short head with large-volume dust channels for smooth transport of the drill dust, minimum generation of heat
- Highest drilling speed: Inclined auxiliary cutting edges for aggressive drill progress
- Optimum centring: Drill-active centering point for optimum guidance when drilling in concrete and armoured concrete
- Precise drilling hole diameters: innovative wear indication (indicator for dimensional conformance)
- Vibration Control: optimised vibration values - ideal for the hardest applications on the construction site
- For use in concrete, masonry, natural stone

Diameter mm	Working length mm	Overall length mm	Sales unit	Order no.
16	200	340	1	623317000*
16	400	540	1	623318000*
18	200	340	1	623319000*
18	400	540	1	623320000*
20	200	320	1	623321000*
20	400	520	1	623322000*
20	800	920	1	623323000*
22	200	320	1	623324000*
22	400	520	1	623325000*
22	800	920	1	623326000*
24	200	320	1	623327000*
24	400	520	1	623328000*
25	200	320	1	623329000*
25	400	520	1	623330000*
25	800	920	1	623331000*
28	400	520	1	623333000*
28	600	720	1	623334000*
30	400	520	1	623339000*
32	200	320	1	623340000*
32	400	520	1	623341000*
32	800	920	1	623342000*
35	400	520	1	623344000*
35	600	720	1	623345000*
38	400	520	1	623347000*
40	400	520	1	623349000*
40	600	720	1	623350000*
45	400	520	1	623337000*
52	400	520	1	623338000*

\*Self-service packaging

# SDS-plus / SDS-max Dust Extraction Drill Bits



- **Drilling and cleaning in one work step** reduces the dust exposure and reworking
- **Greatest reinforcement compatibility**, no sagging or clogging thanks to 4-blade-geometry with extra large dust outlets
- **Noticeably fast drilling progress** thanks to optimal drill dust removal
- **Innovative head design** with greatest concentricity for precise dowel holes



- **Active drill bit cooling** for long service life
- **Dust-free drilling** for compliance with legal provisions on user safety. Up to 98% less dust in the bore
- **Universal vacuum cleaner adapter** fits all standard industrial M-class and H-class vacuum cleaners

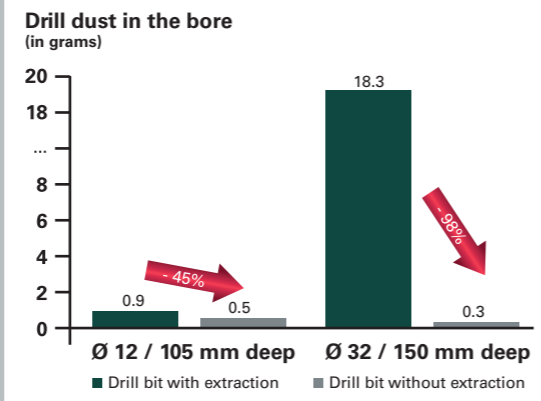

Kindly observe the installation instructions of the manufacturer when using the chemical installations

## SDS-plus and SDS-max Dust Extraction Drill Bits

### Carbide dust extraction drill bits, SDS-plus

	Diameter mm	Working length mm	Overall length mm	Sales unit	Order no.
					
<b>NEW</b>					
	12	200	325	1	626902000*
	14	240	360	1	626903000*
	16	240	360	1	626904000*
	18	240	360	1	626905000*

- Drilling and cleaning in one work step reduces dust exposure and reworking
  - Greatest reinforcement compatibility, no sagging or clogging thanks to 4-blade-geometry with extra large dust outlets
  - Noticeably fast drilling progress thanks to optimal drill dust removal
  - Innovative head design with greatest concentricity for precise dowel holes
  - Active drill bit cooling for long service life
  - Dust-free drilling for compliance with legal provisions on user safety. Up to 98% less dust in the bore
  - Universal vacuum cleaner adapter fits all standard industrial M and H class vacuum cleaners
- Kindly observe the installation instructions of the manufacturer when using the chemical installations

### Carbide dust extraction drill bits, SDS-max

	Diameter mm	Working length mm	Overall length mm	Sales unit	Order no.
					
<b>NEW</b>					
	16	400	600	1	626911000*
	18	400	600	1	626912000*
	20	400	600	1	626913000*
	22	400	600	1	626914000*
	24	400	600	1	626915000*
	25	400	600	1	626916000*
	28	400	600	1	626917000*
	28	700	900	1	626918000*
	30	400	600	1	626919000*
	30	700	900	1	626920000*
	32	400	600	1	626921000*
	32	700	900	1	626922000*
	35	400	600	1	626923000*
	35	700	900	1	626924000*

- Drilling and cleaning in one work step reduces dust exposure and reworking
  - Greatest reinforcement compatibility, no sagging or clogging thanks to 4-blade-geometry with extra large dust outlets
  - Noticeably fast drilling progress thanks to optimal drill dust removal
  - Innovative head design with greatest concentricity for precise dowel holes
  - Active drill bit cooling for long service life
  - Dust-free drilling for compliance with legal provisions on user safety. Up to 98% less dust in the bore
  - Universal vacuum cleaner adapter fits all standard industrial M and H class vacuum cleaners
- Kindly observe the installation instructions of the manufacturer when using the chemical installations

\*Self-service packaging

# Chisels SDS-plus / SDS-max

## Chisels »professional«

### Longest service life and versatility

- Use of high-grade heat-treated steel
- Special processing and hardening procedure, also suitable for re-sharpening
- Extensive range with chisels for many special applications such as channel chisels or stake drivers



## Chisels »professional premium«

### Maximum service life and material removal

- Self-sharpening cutting for highest breaking performance
- Maximum removal thanks to efficient impact transmission and additional cutters
- The innovative head shape reliably prevents wedging
- Special hardened steel and special surface handling ensure longest tool life and productive operation.



## Chisels, SDS-plus »classic«

- Robust, hardened tools with high material quality
- Good cutting output with good tool life

	Chisel shape	Overall length mm	Cutting width	Sales unit	Order no.
	Pointed Chisel	250		1	628406000*
	Flat Chisel	250	20	1	628407000*
	Scaling Chisel	250	40	1	628408000*

## Chisels, SDS-plus »professional«

- Special hardened steel and special surface treatment ensure a long tool life and productive operation
- For use in concrete, masonry, natural stone

	Chisel shape	Overall length mm	Cutting width	Sales unit	Order no.
	Pointed chisel, round tip	250		1	630992000*
	Pointed chisel, square tip	250		1	631421000*
	Pointed chisel, square tip	250		10	631387000
	Flat Chisel	250	20	1	631420000*
	Flat Chisel	250	20	10	631388000
	Scaling Chisel	250	40	1	631425000*
	Tile chisel, offset	165	75	1	631449000*
	Tile chisel, offset	250	40	1	631456000*
	Chasing Gouge	250	22	1	631422000*
	Mortar chisel, carbide-tipped	200		1	631424000*
	<b>SDS-plus chisel set , 3 pieces</b> comprising each 1 pointed chisel, 1 flat chisel and 1 scaling chisel				630478000
	<b>SDS-plus chisel set , 5 pieces</b> comprising each 2 pointed chisels, 2 flat chisels and 1 scaling chisel				630484000

## Chisels, SDS-plus »professional premium«

- Self-sharpening cutting for highest breaking performance
- Maximum removal thanks to efficient impact transmission and additional cutters
- The innovative head shape reliably prevents wedging
- Special hardened steel and special surface handling ensure longest tool life and productive operation.



**NEW**

	Chisel shape	Overall length mm	Cutting width	Sales unit	Order no.
	Pointed Chisel	250		1	629178000*
	Flat Chisel	250	20	1	629179000*

\*Self-service packaging























Chisels, SDS-max »classic«

- Robust, hardened tools with high material quality
- Good cutting output with good tool life

	Chisel shape	Overall length mm	Cutting width	Sales unit	Order no.
	Pointed Chisel	400		1	628409000*
	Flat Chisel	400	25	1	628410000*
	Sealing Chisel	400	50	1	628411000*

Chisels, SDS-max »professional«

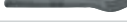

- Special hardened steel and special surface handling ensure long tool life and productive operation.

	Chisel shape	Overall length mm	Cutting width	Sales unit	Order no.
	Pointed chisel, round tip	280		1	623351000*
	Pointed chisel, round tip	400		1	623352000*
	Pointed chisel, round tip	400		10	623463000
	Pointed chisel, round tip	600		1	623358000*
	Flat Chisel	280	25	1	623353000*
	Flat Chisel	400	25	1	623354000*
	Flat Chisel	400	25	10	623464000
	Flat Chisel	600	25	1	623359000*
	Sealing Chisel	400	50	1	623355000*
	Sealing Chisel	300	80	1	623356000*
	Sealing Chisel	350	115	1	623366000*
	Chasing Gouge	300	26	1	623357000*
	Channel Chisel	300	32	1	623365000*
	Tile chisel, offset	400	50	1	623367000*
	Toothed Chisel	300	32	1	623368000*
	Mortar Chisel	300	10	1	623369000
	Spade Chisel	400	110	1	623383000
	Asphalt Cutter	400	90	1	623384000
	Gouge Chisel	380	35	1	623385000
	Stake Driver	260	16.5	1	623386000*
	Stake Driver	260	13	1	623387000*
	<b>SDS-max chisel set, 5 pieces</b> comprising each 2 pointed chisels, 2 flat chisels and 1 scaling chisel				630488000
	<b>SDS-max chisel set, 5 pieces</b> Comprising 3 pointed chisels, 2 flat chisels				630489000

Chisels, SDS-max »professional premium«

- Self-sharpening cutting for highest breaking performance
- Maximum removal thanks to efficient impact transmission and additional cutters
- The innovative head shape reliably prevents wedging
- Special hardened steel and special surface handling ensure longest tool life and productive operation.

**NEW**

	Chisel shape	Overall length mm	Cutting width	Sales unit	Order no.
	Pointed Chisel	400		1	629180000*
	Flat Chisel	400	25	1	629181000*

SDS-max Concrete Core Cutters

Carbide-tipped concrete core cutters (single piece) with SDS-max shank bit

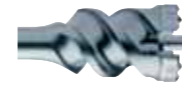

- Optimised pilot drill with 3 blades for greatest compatibility with reinforcements
- Conically designed shank for optimum power transmission and low-vibration drilling
- 3 large spirals for fast drilling progress and faster dust discharge
- Ideal for drilling into hard materials.

Diameter mm	Overall length mm	Order no.
45	550	623375000*
45	990	623376000*
55	550	623377000*
55	990	623378000*
65	550	623379000*
65	990	623380000*
80	550	623381000*
80	990	623382000*

Core Bits



Carbide core cutters with ratio thread



- Sturdy universal tool for hard work in concrete and other building materials

Diameter mm	Working length mm	Order no.
50	100	623034000*
68	100	623035000*
80	100	623036000*
100	100	623032000*
125	100	623031000*

Carbide pilot drills with ratio thread

	Order no.
 <b>Pilot drill 12 x 155 mm</b> ■ For working with the carbide core cutters with ratio thread Diameter: 12 mm	623038000
 <b>Connector</b> ■ Connector with ratio female thread and SDS-max shank end, length 195 mm, for the anchor-head holder 623299000 of concrete core cutters and for mounting core bits with the help of the pilot drill 623038000	623370000*

Arbor for carbide concrete core cutters with ratio thread

	Overall length mm	Order no.
	280	623299000*

\*Self-service packaging



Carbide core cutters with M 16 female thread



- Optimised with larger carbide teeth for longer tool life. Higher power efficiency due to stable, thin-walled bit body.
- For concrete, masonry, natural stone and limestone

Diameter mm	Working length mm	Order no.
30	55	623391000*
35	55	623392000*
40	55	623393000*
50	55	623394000*
68	55	623395000*
82	55	623396000*
100	55	623398000*
112	55	623399000*

Arbors with M16 male thread

- Set with Allen key for locking the pilot drill 627040000.
- For impact operation with light core cutters
- Also suitable for use with »Pionier« universal hole saws.

	Order no.
<p><b>Arbor</b> Shaft type: SDS plus Overall length: 105 mm</p>	627043000*
<p><b>Arbor</b> Shaft type: SDS plus Overall length: 220 mm</p>	627042000*
<p><b>Arbor</b> Shaft type: SW11 Overall length: 90 mm</p>	627041000*

Pilot drill, carbide-tipped

	Order no.
<p><b>Pilot drill</b> ■ For work with the carbide core cutters (M16 female thread) and the universal hole saws »Pionier« (M16 female thread) in combination with one of the arbors Diameter: 8 mm Overall length: 120 mm</p>	627040000*

Diamond Socket Countersink

For general building materials, quality class »professional«



- Ideal for all hard materials, general construction/building site materials such as concrete, exposed aggregate concrete, sand-lime brick, bricks, masonry.
- Segment height: 5.0 mm
- For drilling without impact
- M16 female thread

Diameter mm	Segment height mm	Sales unit	Order no.
68	5	1	628201000
82	5	1	628202000

For abrasive materials, quality class »professional«



- Best suited for use on soft, abrasive materials such as fresh concrete, sand-lime brick, sandstone.
- Segment height: 5.0 mm
- For drilling without impact
- M16 female thread

Diameter mm	Segment height mm	Sales unit	Order no.
68	5	1	628203000
82	5	1	628204000

Pilot drill, carbide-tipped

	Order no.
<p><b>Pilot drill</b> ■ For work with the diamond socket countersinks (M16 female thread) in combination with one of the arbors Diameter: 8 mm Overall length: 130 mm</p>	628207000*

Integral Chucks for Rotary Hammers



Hammer chucks with adapter

	Order no.
<p><b>SDS-plus hammer chuck</b> ■ For tools with SDS-plus shank end ■ Suitable for UHE 22, UHE 28 Multi, BHE 24, BHE 26, KHE 26 Contact, KHE 28</p>	631920000*
<p><b>SDS-plus hammer chuck</b> ■ For tools with SDS-plus shank end ■ Suitable for KHE 32</p>	631922000*
<p><b>SDS-plus hammer chuck</b> ■ For tools with SDS-plus shank end ■ Suitable for: UHE 2250/2650/ KHE 2650/2850/2851</p>	631928000*
<p><b>SDS-plus hammer chuck</b> ■ For tools with SDS-plus shank end ■ Suitable for UHE 28 Plus, KHE 28 Plus</p>	631931000*
<p><b>SDS-plus hammer chuck</b> ■ For tools with SDS-plus shank end ■ Suitable for KHE 2660 Quick, UHE 2660-2 Quick, UHEV 2860-2 Quick, KHE 3251, KHA 36 LTX, KHA 36-18 LTX 32, KHA 18 LTX BL 24</p>	631943000*







Chucks with adapter

	Order no.
<p><b>Geared chuck with adapter</b> ■ For tools with cylindrical shank end ■ Suitable for UHE 22, UHE 28 Multi, BHE 24, BHE 26, KHE 26 Contact, KHE 28 Chuck capacity: 1 - 13 mm</p>	631924000*
<p><b>Keyless chuck with adapter</b> ■ For tools with cylindrical shank end ■ Suitable for UHE 22, UHE 28 Multi, BHE 24, BHE 26, KHE 26 Contact, KHE 28 Chuck capacity: 1.5 - 13 mm</p>	631921000*
<p><b>Keyless chuck with adapter</b> ■ For tools with cylindrical shank end ■ Suitable for UHE 28 Plus, KHE 28 Plus Chuck capacity: 1.5 - 13 mm</p>	631930000*
<p><b>Keyless chuck with adapter</b> ■ For tools with cylindrical shank end ■ Suitable for KHE 32 Chuck capacity: 1 - 13 mm</p>	631923000*

\*Self-service packaging

	Order no.
 <p><b>Keyless chuck with adapter</b></p> <ul style="list-style-type: none"> <li>For tools with cylindrical shank end</li> <li>Suitable for UHE 2250/2850, KHE 2650/2851</li> </ul> <p>Chuck capacity: 1.5 - 13 mm</p>	631927000*
 <p><b>Keyless chuck with adapter</b></p> <ul style="list-style-type: none"> <li>For tools with cylindrical shank end</li> <li>Suitable for KHE 2660 Quick, KHE 2860 Quick, UHE 2660-2 Quick, UHEV 2860-2 Quick, KHE 3251, KHA 36 LTX, KHA 36-18 LTX 32, KHA 18 LTX BL 24</li> </ul> <p>Chuck capacity: 1.5 - 13 mm</p>	631968000*

**More accessories**

	Order no.
 <p><b>Connector</b></p> <ul style="list-style-type: none"> <li>With thread 1/2"-20 UNF.</li> </ul> <p>Holder: SDS-plus, 1/2"- 20 UNF</p>	630928000*
 <p><b>Connector</b></p> <ul style="list-style-type: none"> <li>With 1/2"-20 UNF thread for chuck and hexagon recess 1/4" (6.35 mm) for screwdriver bits with bit retaining bush</li> </ul> <p>Holder: SDS-plus, 1/2"- 20 UNF</p>	631285000*
 <p><b>Connector</b></p> <ul style="list-style-type: none"> <li>Connector from SDS-max to SDS-plus to enable use of SDS-plus drill bits/chisels</li> </ul> <p>Holder: SDS-max, SDS-plus</p>	623371000*
 <p><b>Connector</b></p> <ul style="list-style-type: none"> <li>Connector with ratio female thread and SDS-max shank end, length 195 mm, for the arbor 623299000 of concrete core cutters and for mounting core bits with the help of the pilot drill 623038000</li> </ul> <p>Holder: SDS-max, ratio female thread</p>	623370000*
 <p><b>Vacuum cleaner adapter DDE 14</b></p> <ul style="list-style-type: none"> <li>Vacuum cleaner adapter for extracting drilling dust at the hole entry point</li> <li>Safe and dust-free drilling in walls and ceilings</li> <li>By virtue of the 2-chamber system and the foam rubber gasket it stays attached to almost all (even uneven) surfaces, such as plaster, natural stone and woodchip wallpaper. Minimal drill dust residue at walls and wallpapers.</li> <li>The adapter is put on the existing suction hose. The negative pressure of the vacuum cleaner keeps the adapter to the respective subsurface.</li> </ul> <p>Drill Ø: 4 - 14 mm</p>	630829000*
 <p><b>Vacuum cleaner adapter DDE 72</b></p> <p>Features see above</p> <p>Drill Ø: 72 mm</p>	631343000*
 <p><b>ISA 18 LTX 24 Integrated Dust Extraction</b></p> <ul style="list-style-type: none"> <li>Extremely light and compact dust extraction for dust-free drilling in concrete, stone and masonry</li> <li>Simple, tool-free installation to the cordless hammer KHA 18 LTX BL 24 Quick</li> <li>Ideal for working overhead or in areas sensible to dust</li> <li>Health-friendly working with HEPA filter for smallest dust particles</li> <li>Precise setting for different drilling depths and drill bit lengths</li> <li>Tool-free replaceable suction head with low-wear brushes</li> <li>3 Second delay to extract the remaining dust from the drill hole</li> <li>Transparent collection container can be emptied easily, e.g. for 160 bores Ø 6 / 40 mm</li> <li>100% Drilling performance with active dust extraction thanks to being driven by own motor</li> </ul> <p>Drill bit-Ø: 5 - 16 mm Max. drill bit length: 160 mm Rated input power: 65 W Weight: 1.1 kg Scope of delivery: replacement extraction head, Metaloc II</p>	631341840
 <p><b>Extraction head set, 2 pieces for ISA 18 LTX</b></p> <ul style="list-style-type: none"> <li>Original suction head for highest suction performance with the ISA 18 LTX</li> </ul>	623767000
 <p><b>HEPA filter for ISA 18 LTX</b></p> <ul style="list-style-type: none"> <li>HEPA filter for highest health protection</li> <li>Keeps back 99.995% of fine dusts larger than 0.3 µm</li> </ul>	623768000
 <p><b>Special grease</b></p> <ul style="list-style-type: none"> <li>For shank ends of hammer drill bits, chisels, adapters etc.; prevents friction and wear coefficient; bio-degradable</li> <li>High durability, high resistance to heat, high anti-corrosion properties</li> </ul>	631800000

\*Self-service packaging

# 18 V



Technical data	Cordless Drywall Screwdriver SE 18 LTX 2500	Cordless Drywall Screwdriver SE 18 LTX 4000	Cordless Drywall Screwdriver SE 18 LTX 6000
Type of battery pack	Li-Ion / LiHD	Li-Ion / LiHD	Li-Ion / LiHD
Battery pack voltage	18 V	18 V	18 V
Bit retainer	Hexagon recess 1/4" (6.35 mm)	Hexagon recess 1/4" (6.35 mm)	Hexagon recess 1/4" (6.35 mm)
Maximum torque - soft	9 Nm	7 Nm	5 Nm
No-load speed	0 - 2,500 /min	0 - 4,000 /min	0 - 6,000 /min
Weight (including battery pack)	1.4 kg	1.3 kg	1.3 kg

Scope of delivery	620047	620048	620049
Order no.			
Depth guide	■	■	■
Magnetic bit holder 1/4" (6.35 mm)	■	■	■
Phillips screwdriver bit, size 2/25 mm	■	■	■
Belt hook	■	■	■
2 Li-Power battery packs (18 V/2.0 Ah)	■	■	■
Charger ASC 30-36 V »AIR COOLED«	■	■	■
Plastic carry case	■	■	■

Equipment variants can be found in the Metabo price list and on the internet

**Product advantages**

- Drywall screwdriver with high torque for fixing of gypsum plasterboards and gypsum fibre boards to wood and metal framework
- Drywall screwdriver for fixing gypsum plasterboards to wood and metal; also suitable for gypsum fibre boards to metal frames
- The specialist for gypsum plasterboards in drywall construction situations: high torque for even faster productivity
- Compact and light design for comfortable one-hand operation
- Precise driving of screws by virtue of finely adjustable depth guide and low-noise claw clutch
- Depth guide can be fully removed for inspection during operation
- Variospeed (V) Electronics for working at customised speeds to suit various application materials
- Integrated working light to illuminate the contact area
- Handy belt hook, can be fixed either on the right or left side
- Battery packs with capacity display for checking the charge status

**System components**

- Accessories → 310
- Battery packs → 72



Technical data	Drywall Screwdriver SE 2500	Drywall Screwdriver SE 4000	Drywall Screwdriver SE 6000
Maximum torque - soft	11 Nm	9 Nm	7 Nm
No-load speed	0 - 2,500 /min	0 - 4,400 /min	0 - 6,200 /min
Rated input power	600 W	600 W	600 W
Output power	275 W	275 W	275 W
Bit retainer	Hexagon recess 1/4" (6.35 mm)	Hexagon recess 1/4" (6.35 mm)	Hexagon recess 1/4" (6.35 mm)
Weight (without mains cable)	1.2 kg	1.1 kg	1.1 kg
Cable length	5 m	5 m	5 m

**Scope of delivery**

Order no.	620044	620045	620046
Depth guide	■	■	■
Magnetic bit holder 1/4" (6.35 mm)	■	■	■
Phillips screwdriver bit, size 2/25 mm	■	■	■

**Product advantages**

- Drywall screwdriver with high torque for fixing of gypsum plasterboards and gypsum fibre boards to wood and metal framework
- Drywall screwdriver for fixing gypsum plasterboards to wood and metal; also suitable for gypsum fibre boards to metal frames
- The specialist for gypsum plasterboards in drywall construction situations: high torque for even faster productivity
- Compact and light design for comfortable one-hand operation
- Precise driving of screws by virtue of finely adjustable depth guide and low-noise claw clutch
- Depth guide can be fully removed for inspection during operation
- Variospeed (V) Electronics for working at customised speeds to suit various application materials

**System components**

Accessories → 310



Technical data	Screwdriver USE 8	Screwdriver DWSE 6.3
Maximum torque - soft	31 Nm	12 Nm
No-load speed	0 - 900 /min	0 - 2,100 /min
Rated input power	550 W	550 W
Output power	290 W	290 W
Bit retainer	Hexagon recess 1/4" (6.35 mm)	Hexagon recess 1/4" (6.35 mm)
Weight (without mains cable)	2.3 kg	2.1 kg
Cable length	4 m	4 m

**Scope of delivery**

Order no.	620002	620001
Bit holder with snap ring	■	■
Depth guide sleeve (77 mm long, Ø 18 mm)	■	■
Long side handle	■	



**Product advantages**



- "High Torque" for driving in large screws
- Optimum speed for processing self-drilling screws
- 10-way adjustable torque
- Metabo Marathon-motor with patented dust protection for long service life
- Two-piece depth guide, can be fully removed for inspection during operation
- Robust depth guide sleeve with front aluminium section
- Finely adjustable penetration depth for different materials
- Forward and reverse rotation
- Quick tool change system
- Low-noise claw clutch made from shot-peened fine quality cast for long service life
- Variospeed (V) Electronics for working at customised speeds to suit various application materials
- Robust die cast aluminium gear housing for optimum heat dissipation and long service life
- Auto-stop carbon brushes to protect the motor

**System components**



Accessories → 310

01  
02  
03  
04  
05  
06  
07  
08  
09  
10  
11  
12  
13  
14  
15



Screwdriver bit assortments		Order no.
	<b>Bit-Box Torsion, 10 pieces</b> Consisting of: Phillips bits, sizes 1, 2, 3 (1 each size) Pozidriv bits, sizes 1, 2, 3 (1 each size) each with one bit for slotted screws 0.8 x 5.5 mm, 1.0 x 5.5 mm and 1.2 x 6.5 mm 1 "rapid in/easy out" bit holder	625390000*
	<b>Bit box Torx + Pozidriv, 10 pieces</b> Consisting of: Pozidriv bits, sizes 1, 2, 3 (torsion bits, 1 each size) Torx bits sizes TX 10, 15, 20, 25, 30 and 40 (1 each) 1 "rapid in/easy out" bit holder	625391000*
	<b>Bit Pack, 3 pieces</b> Consisting of: Diamond torsion bits, L = 25 mm □PZ 2 x 1, TX 20 x 1, TX 25 x 1 BitPack: robust, small and compact, with sufficient space for the most important bits Strong magnetic closure for fast access Belt hook 55 mm wide Dimensions: 85 x 55 x 13 mm	626699000



Screwdriver bit assortments, impact-proof		Order no.
	<b>Bit-box impact 29</b> Consisting of: Pozidriv bits, sizes 2, 3 (torsion bits, 1 each size), 29 mm long Torx bits, sizes TX 15, 20, 25, 30, 40 (torsion bits, 1 each size), 29 mm long 1 Bit holder Ideal for powerful drill/screwdrivers and impact drivers and wrenches	628849000*
	<b>Bit-box impact 49</b> Consisting of: Pozidriv bits PZ, sizes 2, 3 (torsion bits, 1 each size), 49 mm long Pozidriv bits TX sizes TX 15, 20, 25, 30, 40 (torsion bits, 1 each size); 49 mm long Ideal for powerful drill/screwdrivers and impact drivers and wrenches	628850000*

Depth stops				
	Length mm	Internal Ø mm	Suitable for machine	Order no.
	77	34	USE 8, DWSE 6.3	625354000

Connectors		Order no.
	<b>Connector</b> Connector, 1/4" hexagon shank / 1/4" male square Overall length: 50 mm	630142000
	<b>Connector</b> Connector, 1/4" external hexagon E6.3 / 1/2" male square Overall length: 72 mm	628838000*
	<b>Adapter</b> Adapter with 1/2" internal square on the machine side and 1/4" internal hexagon for impact-proof tools with 1/4" shank	628836000*

Hexagonal socket wrench inserts 1/4" (6.35 mm) hexagon			
Holder	Overall length mm	Key width	Order no.
1/4" (6.35 mm) hexagonal shank	65	8 mm	628843000*
1/4" (6.35 mm) hexagonal shank	65	10 mm	628845000*
1/4" (6.35 mm) hexagonal shank	65	13 mm	628847000*

Screw-type angle attachments		Order no.
	<b>Screw-type angle attachment</b> ■ Suitable for cordless screwdrivers up to a maximum of 14 Nm and a maximum of 400 rpm ■ Width across corners only 30 mm ■ Magnetic bit holder ■ With 1/4" (6.35 mm) hexagonal shank	630442000*
	<b>Screw-type angle attachment</b> ■ Screw-type angle attachment for professional use. ■ Suitable for cordless screwdrivers up to a maximum of 57 Nm and a maximum of 2,000 rpm ■ Width across corners only 50 mm ■ Bit holder with quick-action coupling ■ With 1/4" (6.35 mm) hexagonal shank ■ Support handle adjustable to 12 positions with lockable push-button	630463000*
	<b>Screw-type angle attachment with bit assortment</b> Features see above Consisting of screw-type angle attachment 6.30463 and 32 piece bit assortment in a practical, sturdy plastic carry case with large viewing panel and additional accessory case Bit assortment comprising: 1x Stainless steel bit holder extension, 150 mm 1 x Phillips Gr. 0, 2x Phillips Gr. 1, 4x Phillips Gr. 2, 1x Phillips Gr. 3 1 x Pozidriv Gr. 0, 2x Pozidriv Gr. 1, 4x Pozidriv Gr. 2, 1x Pozidriv Gr. 3 1 x SL 3.0, 1 x SL 5.0, 1 x SL 6.0 1 x Torx TX 10, 1x Torx TX 15, 3x Torx TX 20, 3x Torx TX 25, 1x Torx TX 30, 1x Torx TX 40 1x Connector for socket wrench	630464000

Screwdriver magazine with accessories					
	Order no.				
	<b>Screwdriver magazine SM 5-55</b> ■ Robust screwdriver magazine for Metabo drywall screwdriver ■ For inserting screws accurately in quick succession ■ Standard 50-screw strips can be used ■ For affixing screws 25-55 mm in length, maximum screw head Ø of 9.5 mm and maximum shaft Ø 5 mm ■ Precision adjustable screw depth ■ Screwdriver magazine removable for single-screw application Standard equipment: 2 x bits PH 2 x 180 mm suitable for: SE 2500 (620044), SE 4000 (620045), SE 6000 (620046), SE 18 LTX 2500 (620047), SE 18 LTX 4000 (620048), SE 18 LTX 6000 (620049)	631618000			
Bit type	Bit size	Overall length mm	Torsion bits	Sales unit	Order no.
	Phillips	size 2	180	• 2	631582000

\*Self-service packaging

10.8 V  
18 V



NEW



NEW



Technical data	Cordless Impact Driver PowerMaxx SSD	Cordless Impact Driver SSD 18 LTX 200 BL	Cordless Impact Wrench SSW 18 LTX 300 BL
Type of battery pack	Li-Ion	Li-Ion / LiHD	Li-Ion / LiHD
Battery pack voltage	10.8 V	18 V	18 V
Max. no-load speed	0 - 2,300 /min	0 - 2,900 /min	0 - 2,650 /min
Maximum impact rate	3,000 /min	4,000 /min	3,750 /min
Maximum torque	105 Nm	200 Nm	300 Nm
Speed/torque levels	1	12	12
Bit retainer	Hexagon recess 1/4" (6.35 mm)	Hexagon recess 1/4" (6.35 mm)	Male square 1/2" (12.70 mm)
Weight (including battery pack)	1 kg	1.7 kg	1.5 kg

Scope of delivery

Order no.	600093	602396 <sup>1)</sup>	602395 Available from September 2018
Belt hook		■	■
2 Li-Power battery packs (10.8 V/2.0 Ah)	■		
2 LiHD battery packs (18 V/4.0 Ah)		■	■
Charger ASC 30-36 V »AIR COOLED«		■	■
Charger LC 40	■		
Plastic carry case	■	■	■

Equipment variants can be found in the Metabo price list and on the internet  
<sup>1)</sup> also available in 120 V (North/Latin America)

Product advantages

- Compact 10.8 Volt cordless impact driver for powerful applications
- Cordless impact driver with 1/4" hexagonal recess and 200 Nm
- Cordless impact driver with 1/2" male square and 300 Nm
- Unique Metabo brushless motor for quick work progress and highest efficiency for any application
- Twelve speed/torque levels for a wide range of applications
- Automatic Power Shift (APS) supports working with self-tapping screws: automatic torque reduction after drilling to prevent overtightening.
- Battery packs with capacity display for checking the charge status
- Handy belt hook, can be fixed either on the right or left side
- Integrated work light to illuminate the workplace

18 V



Technical data	Cordless Impact Wrench SSW 18 LTX 400 BL	Cordless Impact Wrench SSW 18 LTX 600
Type of battery pack	Li-Ion / LiHD	Li-Ion / LiHD
Battery pack voltage	18 V	18 V
Max. no-load speed	0 - 2,150 /min	0 - 1,600 /min
Maximum impact rate	4,250 /min	2,200 /min
Maximum torque	400 Nm	600 Nm
Speed/torque levels	12	1
Bit retainer	Male square 1/2" (12.70 mm)	Male square 1/2" (12.70 mm)
Weight (including battery pack)	1.7 kg	3.2 kg

Scope of delivery

Order no.	602205	602198
Belt hook	■	■
2 LiHD battery packs (18 V/5.5 Ah)		■
2 LiHD battery packs (18 V/4.0 Ah)	■	
Charger ASC 30-36 V »AIR COOLED«	■	■
Plastic carry case	■	■

Equipment variants can be found in the Metabo price list and on the internet

Product advantages

- High torque of 400 Nm whilst offering a particularly handy design
- Unique Metabo brushless motor for quick work progress and highest efficiency for any application
- Twelve speed/torque levels for a wide range of applications
- Extremely powerful with 600 Nm for heavy screwdriving applications
- Battery packs with capacity display for checking the charge status
- Handy belt hook, can be fixed either on the right or left side
- Integrated work light to illuminate the workplace

System components

Accessories → 315 | Battery packs → 72

System components

Accessories → 315 | Battery packs → 72

01  
02  
03  
04  
05  
06  
07  
08  
09  
10  
11  
12  
13  
14  
15



Technical data	Impact Wrench SSW 650
No-load speed	0 - 2,100 /min
Rated input power	650 W
Output power	360 W
Maximum impact rate	2,800 /min
Maximum torque	600 Nm
Speed/torque levels	1
Bit retainer	Male square 1/2" (12.70 mm)
Weight (without mains cable)	3 kg
Cable length	5 m

Order no. 602204 <sup>1)2)</sup>



<sup>1)</sup> also available in 120 V (North/Latin America)  
<sup>2)</sup> also available in 110 V (UK)

**Product advantages** ■ Extremely powerful with 600 Nm for heavy screwdriving applications

System components

Accessories → 315

Screwdriver bit assortments, impact-proof

	Order no.
 <b>Bit-box impact 29</b> Consisting of: Pozidriv bits, sizes 2, 3 (torsion bits, 1 each size), 29 mm long Torx bits, sizes TX 15, 20, 25, 30, 40 (torsion bits, 1 each size), 29 mm long 1 Bit holder Ideal for powerful drill/screwdrivers and impact drivers and wrenches	628849000*
 <b>Bit-box impact 49</b> Consisting of: Pozidriv bits PZ, sizes 2, 3 (torsion bits, 1 each size), 49 mm long Pozidriv bits TX sizes TX 15, 20, 25, 30, 40 (torsion bits, 1 each size); 49 mm long Ideal for powerful drill/screwdrivers and impact drivers and wrenches	628850000*

Connectors





	Order no.
 <b>Connector</b> Connector, 1/4" external hexagon E6.3 / 1/2" male square Overall length: 72 mm	628838000*
 <b>Adapter</b> Adapter with 1/2" female square on the machine side and 1/4" hexagonal recess for impact-proof tools with 1/4" shank	628836000*

Hexagonal socket wrench inserts with 1/4" (6.35 mm), magnetic and impact-proof

 For screwdrivers and impact drivers and wrenches 1/4"  
 Impact-proof: made from chrome Vanadium steel; surface: matt satin; length: 65 mm

Holder	Overall length mm	Key width	Order no.
1/4" (6.35 mm) hexagonal shank	65	8 mm	628843000*
1/4" (6.35 mm) hexagonal shank	65	10 mm	628845000*
1/4" (6.35 mm) hexagonal shank	65	13 mm	628847000*

Accessories for impact drivers and wrenches, ratchet screwdrivers

	Order no.
 <b>Socket wrench set 1/2" (10 pieces)</b> Consisting of 10 socket wrenches (10, 11, 12, 13, 15, 17, 19, 21, 22, 24 mm)	628831000
 <b>Socket wrench set 1/2" (3 pieces)</b> Consisting of 3 socket wrenches (17, 19, 21 mm) For alloy wheel caps, long version	628833000
 <b>Socket wrench extension 1/2" impact-proof</b> Overall length 150 mm	628832000
 <b>Socket wrench set 3/4" (8 pieces)</b> Consisting of 8 socket wrenches (21, 22, 24, 26, 27, 28, 30, 32 mm)	628834000
 <b>Socket wrench set 1" (8 pieces)</b> Consisting of 8 socket wrenches (24, 27, 30, 32, 33, 34, 36, 38 mm) Deep version	628835000

\*Self-service packaging

18 V



Technical data	Cordless Stirrer RW 18 LTX 120
Type of battery pack	Li-Ion / LiHD
Battery pack voltage	18 V
No-load speed	0 - 750 /min
Gears	1
Maximum stirring paddle diameter	120 mm
Max. recommended mixing amount	40 l
Bit retainer	Female thread M 14
Weight (including battery pack)	4.4 kg

Scope of delivery	
Order no.	601163
Stirrer paddle RS-R2	■
2 LiHD battery packs (18 V/5.5 Ah)	■
Charger ASC 30-36 V »AIR COOLED«	■

Equipment variants can be found in the Metabo price list and on the internet

- Product advantages**
- Cordless stirrer for powerful mixing on the construction site
  - Minor effort to guide the stirrer thanks to ergonomically favourable handle position
  - Robust metal gripping frame to protect against damage
  - Battery pack is protected by its location on the top and helps to ensure perfect balance when stirring
  - Vario Constamatic (VC) Electronics for work with materials requiring customised speeds, which remain almost constant under load
  - Overload protection: protects the motor from overheating
  - Electronic soft start for splash-free working
  - Battery packs with capacity display for checking the charge status

**System components**

Accessories → 318 | Battery packs → 72



Technical data	Stirrer RWE 1020	Stirrer RWEV 1200	Stirrer RWEV 1200-2	Stirrer RWEV 1600-2
Rated input power	1,020 W	1,200 W	1,200 W	1,600 W
Output power	520 W	580 W	580 W	660 W
No-load speed	0 - 900 /min	0 - 590 /min	0 - 520 / 0 - 720 /min	0 - 470 / 0 - 680 /min
Gears	1	1	2	2
Maximum stirring paddle diameter	120 mm	140 mm	140 mm	160 mm
Max. recommended mixing amount	30 l	40 l	50 l	90 l
Bit retainer	Female thread M 14	Female thread M 14	Female thread M 14	Female thread M 14
Collar diameter	43 mm	43 mm	43 mm	43 mm
Weight (without mains cable)	3.1 kg	3.4 kg	4.3 kg	4.5 kg
Cable length	4 m	4 m	4 m	4 m

Scope of delivery				
Order no.	614044	614045	614046	614047
Stirrer paddle RS-R2	■			
Stirrer paddle RS-R3		■	■	■

- Product advantages**
- Variospeed (V) Electronics for working at customised speeds to suit various application materials
  - Electronic soft start for splash-free working
  - Vario-Tacho-Constamatic (VTC)-Full Wave Electronics for work with materials requiring customised speeds, which remain constant under load
  - Thumbwheel for speed preselection
  - High torque thanks to two-speed gearbox for viscous materials
  - Robust die cast aluminium gear housing for optimum heat dissipation and long service life
  - Electronic soft start for splash-free working
  - Vario-Tacho-Constamatic (VTC)-Full Wave Electronics for work with materials requiring customised speeds, which remain constant under load
  - Thumbwheel for speed preselection
  - Minor effort to guide the stirrer thanks to ergonomically favourable handle position
  - Rubber corners at the housing for effective protection from damage, safe storage and non-slip leaning against a wall
  - The side cable exit reduces the risk of a cable break
  - Continuous speed control trigger with rubber cover to protect against dust and dirt deposits
  - Splash-water proof motor cover to protect against dirt, mud and splash water

**System components**

Accessories → 318

01

02

03

04

05

06

07

08

09

10

11

12

13

14

15

Stirrer paddles



**Type RS-R3 right spiral – mixing action from bottom to top**

- Ideal for heavy and viscous materials
- Mixing action from bottom to top, agitator screws into the material by itself, bottom ring protects the container
- Particularly suited for all types of mortar, cement and lime plaster, adhesive binders, screeds, tile adhesive, quartz-filled epoxy resins, thermal insulation plaster, concrete, bitumen thick coating, etc.

Diameter mm	Length mm	Maximum material quantity kg	Shaft type	Order no.
120	590	15 - 25	M 14	626734000*
140	590	25 - 40	M 14	626735000*
160	590	30 - 60	M 14	626736000*



**Type RS-R2 right spiral – mixing action from bottom to top**

- Ideal for all sticky and viscous materials
- Mixing action from bottom to top, agitator screws into the material by itself, bottom ring protects the container
- Particularly suited for tile adhesive and construction adhesive, finished mortar and plaster, putties, screed, epoxy resin mixture, adhesive mortars etc.

Diameter mm	Length mm	Maximum material quantity kg	Shaft type	Order no.
100	590	10 - 15	Hexagon 13 mm	626737000*
120	590	10 - 15	M 14	626738000*
140	590	15 - 30	M 14	626739000*



**Type RS-L2 left spiral – mixing action from top to bottom**

- Ideal for runny materials
- Mixing action from top to bottom, the spirals push the material from top to bottom, bottom ring protects the container
- Particularly suited for paint, varnish, base coats, slightly creamy plasters, thin coatings, paste, casting compounds, dispersion adhesives
- Stirrer cage geometry and spiral optimised for splash-free working of runny materials

Diameter mm	Length mm	Maximum material quantity kg	Shaft type	Order no.
80	400	5 - 10	Hexagon 10 mm	626744000*
120	590	20 - 30	M 14	626745000*



**Type RB 4, mixing without air pockets**

- Ideal for all viscous materials which normally tend to cluster into lumps
- Impellers of the whisks generate a high vacuum and effectively prevent the addition of air to the mixture
- Particularly suited for self-levelling filler and levelling mixes, as well as adhesives and sealants, bitumen coatings, putty, epoxy resin coatings etc. ...

Diameter mm	Length mm	Maximum material quantity kg	Shaft type	Order no.
120	590	15 - 25	M 14	626741000*



**Type SR 12 paddles – mixing action from top to bottom**

- Ideal for all liquid and self-levelling materials
- Mixing action from top to bottom, the spirals push the material from top to bottom, bottom ring protects the container
- Quick and homogenous mixing of runny materials
- Particularly suited for the preparation of thin bed mortar for bonding blocks

Diameter mm	Length mm	Maximum material quantity kg	Shaft type	Order no.
120	590	20 - 40	M 14	626742000*
150	590	40 - 65	M 14	626743000*

\*Self-service packaging



06

# Processing of Concrete, Masonry and Plaster



Stirrer paddles



**Type RS-R3 right spiral – mixing action from bottom to top**

- Ideal for heavy and viscous materials
- Mixing action from bottom to top, agitator screws into the material by itself, bottom ring protects the container
- Particularly suited for all types of mortar, cement and lime plaster, adhesive binders, screeds, tile adhesive, quartz-filled epoxy resins, thermal insulation plaster, concrete, bitumen thick coating, etc.

Diameter mm	Length mm	Maximum material quantity kg	Shaft type	Order no.
120	590	15 - 25	M 14	626734000*
140	590	25 - 40	M 14	626735000*
160	590	30 - 60	M 14	626736000*



**Type RS-R2 right spiral – mixing action from bottom to top**

- Ideal for all sticky and viscous materials
- Mixing action from bottom to top, agitator screws into the material by itself, bottom ring protects the container
- Particularly suited for tile adhesive and construction adhesive, finished mortar and plaster, putties, screed, epoxy resin mixture, adhesive mortars etc.

Diameter mm	Length mm	Maximum material quantity kg	Shaft type	Order no.
100	590	10 - 15	Hexagon 13 mm	626737000*
120	590	10 - 15	M 14	626738000*
140	590	15 - 30	M 14	626739000*



**Type RS-L2 left spiral – mixing action from top to bottom**

- Ideal for runny materials
- Mixing action from top to bottom, the spirals push the material from top to bottom, bottom ring protects the container
- Particularly suited for paint, varnish, base coats, slightly creamy plasters, thin coatings, paste, casting compounds, dispersion adhesives
- Stirrer cage geometry and spiral optimised for splash-free working of runny materials

Diameter mm	Length mm	Maximum material quantity kg	Shaft type	Order no.
80	400	5 - 10	Hexagon 10 mm	626744000*
120	590	20 - 30	M 14	626745000*



**Type RB 4, mixing without air pockets**

- Ideal for all viscous materials which normally tend to cluster into lumps
- Impellers of the whisks generate a high vacuum and effectively prevent the addition of air to the mixture
- Particularly suited for self-levelling filler and levelling mixes, as well as adhesives and sealants, bitumen coatings, putty, epoxy resin coatings etc. ...

Diameter mm	Length mm	Maximum material quantity kg	Shaft type	Order no.
120	590	15 - 25	M 14	626741000*



**Type SR 12 paddles – mixing action from top to bottom**

- Ideal for all liquid and self-levelling materials
- Mixing action from top to bottom, the spirals push the material from top to bottom, bottom ring protects the container
- Quick and homogenous mixing of runny materials
- Particularly suited for the preparation of thin bed mortar for bonding blocks

Diameter mm	Length mm	Maximum material quantity kg	Shaft type	Order no.
120	590	20 - 40	M 14	626742000*
150	590	40 - 65	M 14	626743000*

\*Self-service packaging



06

# Processing of Concrete, Masonry and Plaster

# Cutting systems: For low-dust working.

The cutting systems using compact angle grinders bring high performance with low-dust processing of concrete, screed or tiles. With optimally harmonised systems of machines, extraction hoods, special discs and matching vacuum cleaner you can work with high productivity, whilst your working environment remains almost free of dust and your health is protected.

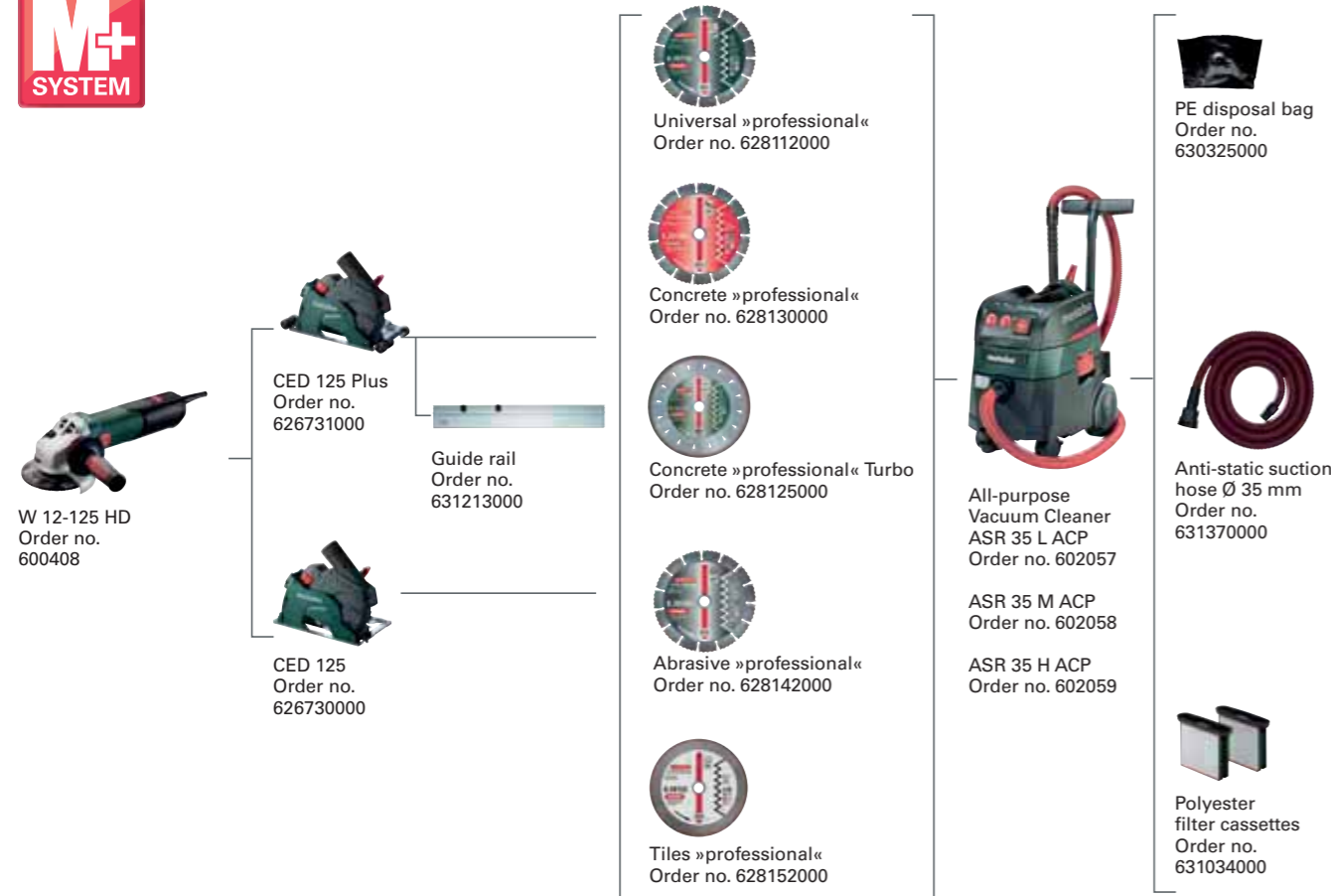

Technical data	Cutting System W 12-125 HD Set CED	Cutting System W 12-125 HD Set CED Plus
Cutting depth adjustable / freehand	0 - 24 mm / 0 - 27 mm	0 - 24 mm / 0 - 27 mm
Cutting disc Ø	125 mm	125 mm
Rated input power	1,250 W	1,250 W
Output power	780 W	780 W
No-load speed	9,600 /min	9,600 /min
Revolutions at rated load	8,800 /min	8,800 /min
Torque	4.1 Nm	4.1 Nm
Spindle threads	M 14	M 14
Weight (without mains cable)	4.2 kg	4.4 kg
Cable length	4 m	4 m

Scope of delivery	600408500 <sup>1)</sup>	600408510 <sup>1)</sup>
Order no.	600408500 <sup>1)</sup>	600408510 <sup>1)</sup>
Guard	■	■
Extraction hood CED 125	■	■
Extraction hood CED 125 Plus		■
Inner support flange	■	■
Nut with two holes	■	■
Metabo VibraTech (MVT) side handle	■	■
Flat-pin spanners	■	■
Diamond cutting disc UP	■	■
MetaLoc case	■	■

<sup>1)</sup> also available in 120 V (North/Latin America)

### Product advantages

- System for low-dust cutting up to 27 mm indoors and outdoors
- Extraction hood CED 125 with plunge function that can be mounted tool-free, made of antistatic plastic
- Robust, detachable metal table for stable working close to walls and for freehand cuts
- System for precise, low-dust cutting up to 27 mm deep, indoors and outdoors
- Extraction hood CED 125 Plus with plunge function, that can be mounted tool-free, made of antistatic plastic
- Robust, removable metal table with rollers for tilt-free, gentle operation on delicate surfaces
- Can be used with guide rail for precise cuts
- Longer service life, more power: the Metabo Marathon-motor with patented dust protection, up to 20% more overload capacity and 50% more torque
- Low-vibration side handle Metabo VibraTech (MVT)
- Metabo S-automatic mechanical safety clutch: minimises kick-back to the lowest level when the disc jams unexpectedly - for maximum user safety and swift progress
- Restart protection after power interruption
- Auto-stop carbon brushes to protect the motor
- Aluminium flange for long service life using heavy accessories, e.g. diamond discs
- Connection for dust extraction Ø 35/41 mm



**Almost dust-free working** from mineral dust

- Plunge function for low-dust start up
- Antistatic plastic for continuously high suction performance



**Precise longitudinal cuts**

- Guide rollers for precise directional stability
- Adjustable cutting depth
- Optional use of a guide rail for precise cut



**Ideal for free-hand cuts**

- Tool-free, quick removal of the base plate
- Perfect for the renovation of cracks

### System components

Accessories → 324

Extraction systems → 453

# The new wall chaser MFE 40: Quick, clean channelling in a single operation.

With the new high-performance MFE 40 wall chaser, and the use of the new diamond cutting disc, you can cut wall channels in just one working step. No need for elaborate mortising or chiselling out between cuts. And in combination with our all-purpose vacuums, dust-free working is guaranteed.



**Maximum work progress**  
thanks to powerful 1900 W motor, constant speed maintenance and new diamond discs



**Safe working conditions**  
thanks to electronic soft start, restart protection and robust die-cast aluminium hood



**Optimum handling**  
Comfortable to use thanks to sliding cut providing optimal view of the marking line, and bow-type handles for optimal horizontal and vertical working



**Clean, low-dust working**  
in combination with a Metabo all-purpose vacuum cleaner (certified by BG BAU)

MFE 40



**Up to 50% time saving**  
The high performance of the MFE 40 permits the use of the **new diamond cutting discs**, which can be used to make **wall channels in a one step process**.



**Widest range of applications**  
Adjustable cutting depth 10 - 40 mm and cutting width 9 - 35 mm permits diverse applications with cutting disc Ø 125 mm.



**Certified extraction system**  
The system is complemented by perfect compatibility with our all-purpose vacuum cleaners, the efficiency for **low-dust working** of which was certified by the BG BAU.

NEW



Technical data	Wall Chaser MFE 40	Wall Chaser MFE 65
Adjustable cutting depth	10 - 40 mm	20 - 65 mm
Possible groove widths	9 / 15.5 / 22 / 28.5 / 35 mm	9 / 11 / 17 / 23 / 29 / 33 / 37 / 41 mm
Cutting disc Ø	125 mm	230 mm
Rated input power	1,900 W	2,400 W
Output power	1,120 W	1,600 W
No-load speed	5,000 /min	6,500 /min
Revolutions at rated load	4,200 /min	4,600 /min
Torque	2.6 Nm	15 Nm
Weight (without mains cable)	4.6 kg	9.8 kg
Cable length	4 m	4 m

Scope of delivery	604040 <sup>1) 2)</sup>	600365 <sup>2)</sup>
Order no.	604040 <sup>1) 2)</sup>	600365 <sup>2)</sup>
Spacer rings	■	■
2 Diamond cutting discs	■	■
Flange nut	■	■
Side handle	■	■
Face pin wrench	■	■
Chase extraction chisel	■	■
Metal carry case	■	■
Plastic carry case	■	■

<sup>1)</sup> also available in 120 V (North/Latin America)  
<sup>2)</sup> also available in 110 V (UK)

**Product advantages**

- Ideal for electric installations to lay cables and pipework under plaster with cutting depths up to 40 mm
- Maximum work progress by means of powerful motor, constant speed and two-speed high-performance gear
- Robust aluminium die-cast hood with rubber rollers and optimal handle position for comfortable guidance of the machine
- Push cut for optimal view of the marking line
- Tacho Constamatic (TC) Full-wave Electronics: fast work progress by means of constant speed under load
- Clean, low-dust working by means of connecting a Metabo all-purpose vacuum cleaner (certified with ASR 35 M ACP)
- Metabo S-automatic safety clutch: mechanical decoupling of the drive for safe working should the disc stop unexpectedly
- Ideal for sanitary installations to lay water pipes and trunking under plaster with cutting depths up to 65 mm
- Electronic overload protection for long service life
- Starting current limitation prevents the actuation of the lock on start-up
- Clean, low-dust working by connecting a Metabo all-purpose vacuum cleaner
- Metabo VibraTech (MVT): integrated damping system to reduce vibrations in order to protect the user's health
- Electronic safety shutdown of the motor for safe working in case the disc stops unexpectedly
- Metabo Marathon-motor with patented dust protection for long service life
- Electronic soft start and restart protection for safe working
- LED signal informs about overload or active restart protection
- Also suitable for cutting with only one diamond cutting disc

**System components**

Accessories → 324

Extraction systems → 453

### Diamond Cutting Discs

#### For hard building materials



**Quality class »professional« / CP**

- Ideal for all hard building materials such as concrete (including reinforced), concrete pipes, granite, hard sandstones, facing stones, exposed aggregate concrete.
- The diamond quality and soft bond provides optimal cutting performance and long tool life
- Laser welded diamond segments
- Segment height: 12.0 mm; maximum working speed 80 m/s (300 - 350 mm: 100 m/s)

Diameter x bore mm	Segment dimensions mm	Number of segments	Maximum speed /min	Sales unit	Order no.
125 x 22.23	32 x 2.15 x 12	9	12,200	1	628130000*
125 x 22.23	32 x 2.15 x 12	9	12,200	2	628131000*
230 x 22.23	40 x 2.5 x 12	15	6,600	1	628134000*
230 x 22.23	40 x 2.5 x 12	15	6,600	2	628135000*

#### For general building materials



**Quality class »professional« / UP**

- Best suited for general construction/building site materials such as concrete, exposed aggregate concrete, hard sandstone, clay tiles.
- The universal disc with high quality diamonds for optimal cutting performance and a long tool life.
- Laser welded diamond segments
- Segment height: 12.0 mm; maximum working speed 80 m/s (300 - 400 mm: 100 m/s)

Diameter x bore mm	Segment dimensions mm	Number of segments	Maximum speed /min	Sales unit	Order no.
125 x 22.23	32 x 2.15 x 12	9	12,200	1	628112000*
125 x 22.23	32 x 2.15 x 12	9	12,200	2	628113000*
230 x 22.23	40 x 2.5 x 12	15	6,600	1	628116000*
230 x 22.23	40 x 2.5 x 12	15	6,600	2	628117000*



**Quality class »professional« / UP-T**

- Best suited for general construction/building site materials such as concrete, exposed aggregate concrete, hard sandstone, clay tiles.
- The circumferentially closed »Turbo« cutting edge provides a clean cutting edge without material chipping, providing optimal cutting performance and long tool life.
- Sintered cutting edge
- Segment height: 9.6 mm; Maximum working speed 80 m/s

Diameter x bore mm	Segment dimensions mm	Maximum speed /min	Sales unit	Order no.
125 x 22.23	2.2 x 9.6	12,200	1	628125000*
230 x 22.23	2.7 x 9.6	6,600	1	628128000*

#### For tiles



**Quality class »professional« / TP**

- Special disc to meet the highest demands for all types of tiles, glazed and unglazed, natural stone slabs, fine earthenware
- Optimal cutting quality and long tool life.
- Sintered cutting edge
- Segment height: 10.0 mm; Maximum working speed 80 m/s

Diameter x bore mm	Segment dimensions mm	Maximum speed /min	Sales unit	Order no.
125 x 22.23	1.7 x 10	12,200	1	628152000*
230 x 22.23	1.7 x 10	6,600	1	628155000*

\*Self-service packaging

### Diamond Cutting Discs

#### Quality class »professional« / UP-T

- High time saving thanks to single step cutting process
- Fast and comfortable cutting of wall slots in diverse materials with the MFE 40
- Highly reduced workload thanks to the intelligent system of interlacing arrangement of segments, since removal of the centre section is not required.
- Reduction of dirt and dust, since the material is removed cleanly and completely from the slot
- Customised slots for individual lines Ø 12 mm, or for Ø 20 and 25 mm-empty pipes. Max. cutting width: 20 mm (2 rows) / 30 mm (3 rows)

	Diameter x bore mm	Segment dimensions mm	Number of segments	Maximum speed /min	Sales unit	Order no.
	125 x 22.23	18 x 7	20	12,200	1	628298000*
	125 x 22.23	28.5 x 7	30	12,200	1	628299000*

#### Further accessories for wall chasers and cutting systems



**Suction hose**

- When using a second suction hose, the dust extraction device can be placed at a distance of up to 8 m from the work area
- With bayonet fitting for attaching to the extraction nozzle of the wall chasers MFE 30, MFE 65
- Connector Ø: 35/35 mm
- Hose Length: 4 m
- Suction hose Ø: 35 mm



**Guide rail**

- Guide rail made of sturdy, anodised aluminium extrusion
- Anti-slip backing provides safe and reliable support and protects the work piece surface against scratches
- Guide rule, adjustable to eliminate play
- suitable for: W 12-125 HD Set CED / W 12-125 HD Set CED Plus



**Coupling bush Ø 41/ 48 mm**

- Particularly suited for coarse dirt, as well as tools with high generation of dust.
- Conducts electricity
- Inner/outer Ø: 41/ 48 mm
- Suitable for all Metabo suction hoses with diameter 35 mm

# Renovation grinder: Efficient removal of old coatings.

With its 1,900 Watt powerful Marathon motor, highly robust diamond cup wheels, optimal extraction and perfect ergonomics, the new RSEV 19-125 RT is the perfect problem solver for floor preparation, the removal of seams in formwork or the levelling of concrete.

Perfect ergonomics thanks to slim handle area for maximum control and easy working overhead



Maximum productivity with 1,900 Watt and low weight

Optimal extraction thanks to spring-mounted brush rim that adapts to very surface and height

Working close to edges thanks to integrated folding segment

Maximum service life thanks to aluminium extraction hood

RSEV 19-125 RT



For effective grinding and removal of concrete, screed and coatings with diamond cup wheels.



**Maximum productivity with the right system**  
Metabo renovation grinders, cup wheels and vacuum cleaners are perfectly compatible and provide excellent work results.



**For the removal of plaster, adhesive remains and coatings:**  
The new powerful renovation milling machine RFEV 19-125 RT with further improved milling heads.

## Which machine and accessories for which application?

Areas of application		for small areas up to ~ 50 m <sup>2</sup>			for medium areas up to ~ 100 m <sup>2</sup>			for medium areas up to ~ 100 m <sup>2</sup>		for small areas up to ~ 50 m <sup>2</sup>		
Type		Renovation Grinder WE15-125 HD Set GED			Renovation Grinder RSEV 19-125 RT			Renovation Milling Machine RFEV 19-125 RT				
Accessories		Diamond cup wheel concrete »pro« Ø 125 mm	Diamond cup wheel abrasive »pro« Ø 125 mm	PCD cup wheel »pro« Ø 125 mm	Diamond cup wheel concrete »pro« Ø 125 mm	Diamond cup wheel abrasive »pro« Ø 125 mm	PCD cup wheel »pro« Ø 125 mm	Milling head flat tooth (complete) Ø 115 mm / M14	Milling head pointed (complete) Ø 115 mm / M14	Diamond cup wheel concrete »pro« Ø 125 mm	Diamond cup wheel abrasive »pro« Ø 125 mm	PCD cup wheel »pro« Ø 125 mm
		Order no. 628205000	Order no. 628206000	Order no. 628208000	Order no. 628205000	Order no. 628206000	Order no. 628208000	Order no. 628219000	Order no. 628218000	Order no. 628205000	Order no. 628206000	Order no. 628208000
Concrete	Fresh concrete	<input type="checkbox"/>	<input checked="" type="checkbox"/>	<input type="checkbox"/>	<input type="checkbox"/>	<input checked="" type="checkbox"/>	<input type="checkbox"/>	<input type="checkbox"/>	<input type="checkbox"/>	<input type="checkbox"/>	<input type="checkbox"/>	<input type="checkbox"/>
	Old concrete/very hard concrete > B35	<input checked="" type="checkbox"/>	<input type="checkbox"/>	<input type="checkbox"/>	<input checked="" type="checkbox"/>	<input type="checkbox"/>	<input type="checkbox"/>	<input type="checkbox"/>	<input type="checkbox"/>	<input type="checkbox"/>	<input type="checkbox"/>	<input type="checkbox"/>
Adhesive	Tile cement	<input type="checkbox"/>	<input checked="" type="checkbox"/>	<input type="checkbox"/>	<input type="checkbox"/>	<input checked="" type="checkbox"/>	<input type="checkbox"/>	<input type="checkbox"/>	<input checked="" type="checkbox"/>	<input type="checkbox"/>	<input checked="" type="checkbox"/>	<input type="checkbox"/>
	Elastic adhesive	<input type="checkbox"/>	<input type="checkbox"/>	<input checked="" type="checkbox"/>	<input type="checkbox"/>	<input type="checkbox"/>	<input checked="" type="checkbox"/>	<input type="checkbox"/>	<input checked="" type="checkbox"/>	<input type="checkbox"/>	<input type="checkbox"/>	<input checked="" type="checkbox"/>
Screed	Soft	<input type="checkbox"/>	<input checked="" type="checkbox"/>	<input type="checkbox"/>	<input type="checkbox"/>	<input checked="" type="checkbox"/>	<input type="checkbox"/>	<input checked="" type="checkbox"/>	<input checked="" type="checkbox"/>	<input type="checkbox"/>	<input type="checkbox"/>	<input type="checkbox"/>
	Hard	<input checked="" type="checkbox"/>	<input type="checkbox"/>	<input type="checkbox"/>	<input checked="" type="checkbox"/>	<input type="checkbox"/>	<input type="checkbox"/>	<input type="checkbox"/>	<input type="checkbox"/>	<input type="checkbox"/>	<input type="checkbox"/>	<input type="checkbox"/>
Plaster	Removal/cutting of hard cement plaster and / or (cement lime plaster) with high sand content	<input checked="" type="checkbox"/>	<input type="checkbox"/>	<input checked="" type="checkbox"/>	<input checked="" type="checkbox"/>	<input type="checkbox"/>	<input checked="" type="checkbox"/>	<input type="checkbox"/>	<input checked="" type="checkbox"/>	<input checked="" type="checkbox"/>	<input type="checkbox"/>	<input checked="" type="checkbox"/>
	Grinding / removal of hard cement plaster	<input checked="" type="checkbox"/>	<input type="checkbox"/>	<input type="checkbox"/>	<input checked="" type="checkbox"/>	<input type="checkbox"/>	<input type="checkbox"/>	<input type="checkbox"/>	<input checked="" type="checkbox"/>	<input checked="" type="checkbox"/>	<input type="checkbox"/>	<input type="checkbox"/>
	Grinding / removal of hard plaster (cement lime finishing plaster)	<input type="checkbox"/>	<input type="checkbox"/>	<input type="checkbox"/>	<input type="checkbox"/>	<input type="checkbox"/>	<input type="checkbox"/>	<input type="checkbox"/>	<input checked="" type="checkbox"/>	<input type="checkbox"/>	<input type="checkbox"/>	<input type="checkbox"/>
	Grinding / removal of synthetic resin plaster	<input type="checkbox"/>	<input type="checkbox"/>	<input checked="" type="checkbox"/>	<input type="checkbox"/>	<input type="checkbox"/>	<input checked="" type="checkbox"/>	<input type="checkbox"/>	<input checked="" type="checkbox"/>	<input type="checkbox"/>	<input type="checkbox"/>	<input checked="" type="checkbox"/>
	Grinding / removal of lime plaster, gypsum plaster	<input type="checkbox"/>	<input checked="" type="checkbox"/>	<input type="checkbox"/>	<input type="checkbox"/>	<input checked="" type="checkbox"/>	<input type="checkbox"/>	<input checked="" type="checkbox"/>	<input type="checkbox"/>	<input type="checkbox"/>	<input checked="" type="checkbox"/>	<input type="checkbox"/>
	Removal of gypsum filler	<input type="checkbox"/>	<input checked="" type="checkbox"/>	<input type="checkbox"/>	<input type="checkbox"/>	<input checked="" type="checkbox"/>	<input type="checkbox"/>	<input checked="" type="checkbox"/>	<input type="checkbox"/>	<input type="checkbox"/>	<input type="checkbox"/>	<input checked="" type="checkbox"/>
Colour / coating	Latex colours and oil colours	<input type="checkbox"/>	<input type="checkbox"/>	<input type="checkbox"/>	<input type="checkbox"/>	<input type="checkbox"/>	<input checked="" type="checkbox"/>	<input checked="" type="checkbox"/>	<input checked="" type="checkbox"/>	<input type="checkbox"/>	<input type="checkbox"/>	<input checked="" type="checkbox"/>
	Elastic protective coatings (concrete colour)	<input type="checkbox"/>	<input type="checkbox"/>	<input type="checkbox"/>	<input type="checkbox"/>	<input type="checkbox"/>	<input checked="" type="checkbox"/>	<input type="checkbox"/>	<input checked="" type="checkbox"/>	<input type="checkbox"/>	<input type="checkbox"/>	<input checked="" type="checkbox"/>
	Bitumen	<input type="checkbox"/>	<input type="checkbox"/>	<input type="checkbox"/>	<input type="checkbox"/>	<input type="checkbox"/>	<input checked="" type="checkbox"/>	<input type="checkbox"/>	<input type="checkbox"/>	<input type="checkbox"/>	<input type="checkbox"/>	<input checked="" type="checkbox"/>
	PU Polyurethane	<input type="checkbox"/>	<input type="checkbox"/>	<input type="checkbox"/>	<input type="checkbox"/>	<input type="checkbox"/>	<input checked="" type="checkbox"/>	<input checked="" type="checkbox"/>	<input type="checkbox"/>	<input type="checkbox"/>	<input type="checkbox"/>	<input checked="" type="checkbox"/>
	Epoxy	<input type="checkbox"/>	<input type="checkbox"/>	<input type="checkbox"/>	<input type="checkbox"/>	<input type="checkbox"/>	<input checked="" type="checkbox"/>	<input type="checkbox"/>	<input checked="" type="checkbox"/>	<input type="checkbox"/>	<input type="checkbox"/>	<input checked="" type="checkbox"/>
Natural stone / ceramic	Granite	<input checked="" type="checkbox"/>	<input type="checkbox"/>	<input type="checkbox"/>	<input checked="" type="checkbox"/>	<input type="checkbox"/>	<input type="checkbox"/>	<input type="checkbox"/>	<input type="checkbox"/>	<input type="checkbox"/>	<input type="checkbox"/>	<input type="checkbox"/>
	Ceramic	<input checked="" type="checkbox"/>	<input type="checkbox"/>	<input type="checkbox"/>	<input checked="" type="checkbox"/>	<input type="checkbox"/>	<input type="checkbox"/>	<input type="checkbox"/>	<input type="checkbox"/>	<input type="checkbox"/>	<input type="checkbox"/>	<input type="checkbox"/>
	Marble	<input type="checkbox"/>	<input checked="" type="checkbox"/>	<input type="checkbox"/>	<input type="checkbox"/>	<input checked="" type="checkbox"/>	<input type="checkbox"/>	<input type="checkbox"/>	<input type="checkbox"/>	<input type="checkbox"/>	<input type="checkbox"/>	<input type="checkbox"/>

very suitable  highly suitable



Technical data	Renovation Grinder WE 15-125 HD Set GED
Grinding wheel Ø	125 mm
Torque	4.2 Nm
No-load speed	9,600 /min
Rated input power	1,550 W
Output power	940 W
Revolutions at rated load	9,600 /min
Spindle threads	M 14
Weight (without mains cable)	2.7 kg
Cable length	4 m

#### Scope of delivery

Order no.	600465510 <sup>1)</sup>
Guard	■
Extraction hood GED 125	■
Inner support flange	■
Nut with two holes	■
Metabo VibraTech (MVT) side handle	■
Flat-pin spanners	■
Diamond cup wheel concrete »Professional«	■
MetaLoc case	■

<sup>1)</sup> also available in 120 V (North/Latin America)

#### Product advantages

- Universally applicable system for low-dust grinding indoors and outdoors
- Longer service life, more power: the Metabo Marathon-motor with patented dust protection, up to 20% more overload capacity and 50% more torque
- Tacho Constamatic (TC) Full-wave Electronics: fast work progress by means of constant speed under load
- Low-vibration side handle Metabo VibraTech (MVT)
- Metabo S-automatic mechanical safety clutch: minimises kick-back to the lowest level when the disc jams unexpectedly - for maximum user safety and swift progress
- Electronic overload protection, soft start and restart protection
- Auto-stop carbon brushes to protect the motor
- Aluminium flange for long service life using heavy accessories, e.g. diamond discs
- Extraction hood GED 125 can be mounted tool-free, made of antistatic plastic
- Fixed segment can be opened manually for near-wall operation
- Connection for dust extraction Ø 35/41 mm

#### System components

Accessories → 331

Extraction systems → 453



Technical data	Renovation Grinder RSEV 19-125 RT
Grinding wheel Ø	125 mm
Torque	5 Nm
No-load speed	3,800 - 8,200 /min
Rated input power	1,900 W
Output power	1,240 W
Revolutions at rated load	6,800 /min
Spindle threads	M 14
Weight (without mains cable)	3.5 kg
Cable length	4 m

#### Scope of delivery

Order no.	603825 <sup>1)</sup>
Bow-type handle	■
Inner support flange	■
Nut with two holes	■
Flat-pin spanners	■
Plastic carry case	■

<sup>1)</sup> also available in 120 V (North/Latin America)

#### Product advantages

- For effective spot grinding and removal of concrete, screed and coatings with diamond cup wheels
- Maximum productivity thanks to top 1,900 Watt with low weight
- High torque and overload capacity for demanding applications in continuous use
- Low weight, ideal for sanding walls and ceilings
- Perfect ergonomics thanks to slim handle for maximum control and easy working overhead
- Working close to edges thanks to integrated folding segment
- Optimum extraction results: spring-mounted brush rim at the guard that adapts to any surface and segment height
- Front handle for safe and uniform guidance when polishing, adjustable without tools
- Vario Tacho Constamatic (VTC) Full-wave Electronics with Thumbwheel: for working at customised speeds to suit the application material and speeds that remain almost constant, even under load
- Electronic soft start for smooth start-up
- Restart protection: prevents unintentional start-up after power supply interruption
- Metabo S-automatic safety clutch: mechanical decoupling of the drive for safe working should the tool stop unexpectedly

#### System components

Accessories → 331

Extraction systems → 453



Technical data	Renovation Milling Machine RFEV 19-125 RT
Working width	125 mm
Cutting depth	0 - 6 mm
Torque	16.8 Nm
No-load speed	750 - 3,100 /min
Rated input power	1,900 W
Output power	1,240 W
Revolutions at rated load	2,800 /min
Spindle threads	M 14
Weight (without mains cable)	3.8 kg
Cable length	4 m

#### Scope of delivery

Order no.	603826 <sup>1)</sup>
Bow-type handle	■
Flat-pin spanners	■
Hexagonal wrench	■
Plastic carry case	■

<sup>1)</sup> also available in 120 V (North/Latin America)

#### Product advantages

- For effective removal of plaster, adhesive residues, soft screed and old paint from walls, ceilings and floors
- Maximum productivity thanks to top 1,900 Watt with low weight
- Double reduction high-performance gearing for maximum torque and high output
- Fast work progress thanks to large milling diameter
- Perfect ergonomics thanks to slim handle for maximum control and easy working overhead
- Cutting depth can be adjusted easily and without the need for tools
- Robust guard made from die-cast aluminium with spring-mounted brush rim for low-dust working
- Front handle for safe and uniform guidance when milling, adjustable without tools
- Can be used as renovation grinder on smaller areas when using a diamond cup wheel
- Vario Tacho Constamatic (VTC) Full-wave Electronics with Thumbwheel: for working at customised speeds to suit the application material and speeds that remain almost constant, even under load
- Electronic soft start for smooth start-up
- Restart protection: prevents unintentional start-up after power supply interruption

#### System components

Accessories → 332

Extraction systems → 453

## Diamond Cup Wheels

### For hard materials, quality class concrete »professional«



- Powerful diamond grinding wheel. Particularly suited for grinding of thick concrete layers, levelling of concrete, preparation of concrete, removal of sludge residue and formwork seams on concrete, removal of hard cement, chalk-cement-plaster, hard screed, levelling of granite, natural stone and other very hard materials, for clean processing of edges, without chipping
- Maximum working speed 80 m/s

Diameter x bore mm	Number of segments	Sales unit	Order no.
125 x 22.23	16	1	628205000*

### For abrasive materials, quality class abrasive »professional«



- Powerful diamond grinding cup wheel. Particularly suited for grinding of fresh concrete coatings, chalk and cement plaster, gypsum filler, levelling of fresh screed, removal of tile adhesive and processing of marble
- Maximum working speed 80 m/s

Diameter x bore mm	Number of segments	Sales unit	Order no.
125 x 22.23	16	1	628206000*

### For protective concrete coatings, quality class »professional«



- Powerful specialized cup wheel. Ideally suited for spot grinding and removal of elastic protective coatings (on soft and hard surfaces), adhesives, sealants, removal of latex and oil paints, bitumen, PU/polyurethane, epoxy, elastic adhesive, for removal of lime plaster and gypsum plaster, abrading of resin plaster and hard cement plaster.
- Cup wheel equipped with PCD segments (poly-crystalline diamonds). By virtue of the PCD segments, particularly problematic coatings are removed quickly and effectively without bonding.
- Maximum working speed 80 m/s

Diameter x bore mm	Number of segments	Sales unit	Order no.
125 x 22.23	12	1	628208000*

### For hard materials, quality class concrete »classic«



- Double-coated diamond cup wheel for grinding of thick concrete layers, levelling of concrete, preparation of concrete, removal of sludge skins and formwork seams on concrete, removal of hard cement, chalk-cement-plaster, hard screed, levelling of granite, natural stone and other very hard materials
- Maximum working speed 80 m/s

Diameter x bore mm	Number of segments	Sales unit	Order no.
125 x 22.23	20	1	628209000*

## Further Accessories for Renovation Grinders





### Replacement Brush Rim



- Replacement brush rim RS
- Suitable for RFEV 19-125 RT

Order no.  
628214000\*

\*Self-service packaging

Milling heads		Order no.
	<b>Milling head pointed complete</b> <ul style="list-style-type: none"> <li>■ Milling head pointed head - contact face tipped with 10 carbide stars</li> <li>■ For the removal of hard plaster, concrete, foam backing, adhesive remains, paint coatings on plaster, synthetic resin plaster, elastic protective coatings, plaster on beams and latex / oil paint on plaster</li> <li>■ The subsurface is roughened by the pointed shape of the milling stars</li> <li>■ Suitable for RFEV 19-125 RT</li> </ul>	628218000*
	<b>Milling head flat complete</b> <ul style="list-style-type: none"> <li>■ Milling head flat head - contact face tipped with 10 carbide stars</li> <li>■ For the removal of soft materials such as plaster, fresh ("green") concrete, foam backing and adhesive remains, soft PU coatings, paint coatings on plaster, plaster on wooden beams, latex / oil paint on plaster, formwork joints and concrete runs on fresh concrete areas</li> <li>■ The subsurface becomes smooth thanks to the flat shape of the milling stars (pulling cut)</li> <li>■ Suitable for RFEV 19-125 RT</li> </ul>	628219000*
Milling stars		Order no.
	<b>10 Milling stars, pointed head</b> <ul style="list-style-type: none"> <li>■ For retrofitting the milling head of the RF 14-115 RFEV 19-125 RT</li> <li>■ With 5 micro-encapsulated screws for safe fixing</li> </ul>	628270000*
	<b>10 Milling stars flat head</b> <ul style="list-style-type: none"> <li>■ For retrofitting the milling head of the RF 14-115 RFEV 19-125 RT</li> <li>■ With 5 micro-encapsulated screws for safe fixing</li> </ul>	628271000*
Replacement brush rim		Order no.
	<b>Replacement brush rim RF</b> <ul style="list-style-type: none"> <li>■ Suitable for RFEV 19-125 RT</li> </ul>	628215000*



**Sanding  
Milling  
Planing**

\*Self-service packaging



# The Metabo random orbital sanders: A team for any application.

Economical working, high surface quality, excellent extraction performance, perfect ergonomics - these are the requirements for a good sander. All our random orbital sanders can score here and each of them has its very particular application focus: The small random orbital sander SX E 400 shows its advantages on small surfaces and curves. The versatile SXE 450 TurboTec can show its potential with its "Duo" oscillating orbit setting for fine and coarse applications. The two new random orbital sanders SXE 150 BL with 2.5 mm / 5 mm orbit diameter provides enormous power and perfect surface quality with extremely compact dimensions and very low weight.

Low vibrations  
for comfortable working  
in continuous mode



Sanding pad Ø 150 mm with multi perforation for effective extraction and a longer service life of the sanding medium (sanding pad Ø 125 mm as accessory 630264000)



BRUSHLESS MOTOR

Effective Brushless motor with selectable speed



Soft start

minimises surface marks when putting the machine on the surface



Motor and plate brake

permits fast putting down of the machine



SXE 150-2.5 BL/  
SXE 150-5.0 BL



### Technical data

	Palm Grip Random Orbital Sander FSX 200 Intec	Random Orbital Sander SX E 400
Diameter of backing pad	125 mm	80 mm
No-load speed	11,000 /min	5,000 - 10,000 /min
Rated input power	240 W	220 W
Output power	90 W	100 W
Revolutions at rated load	9,500 /min	6,000 /min
Orbit diameter	2.7 mm	3 mm
Weight (without mains cable)	1.3 kg	1.2 kg
Cable length	2.8 m	2.5 m

### Scope of delivery

Order no.	609225 <sup>1)</sup>	600405 <sup>1)</sup>
Hook and loop intermediate disc		■
Hexagonal wrench		■
Dust collection cartridge	■	
1 Pleated filter	■	
Plastic carry case	■	

<sup>1)</sup> also available in 120 V (North/Latin America)

### Product advantages

- Very good weight/performance ratio for low-fatigue working
- Grip area with non-slip soft-grip surface
- Dust collector cartridge with filter for working without connecting to a vacuum cleaner
- Extraction possibility by means of connecting to an all-purpose vacuum cleaner via an adapter (accessory)
- Small 80 mm backing pad and flexible intermediate disc for sanding inner and outer curves.
- Ideally suited for sanding and polishing smaller surfaces
- Variospeed (V) Electronics for working at customised speeds to suit various application materials
- Thumbwheel for speed preselection
- Power Control System: No scratches when placing the machine directly onto the material at speed
- Compact housing design aids sanding in confined spaces
- Extraction possibility by means of connecting an all-purpose vacuum cleaner
- Light and handy machine for convenient one-hand operation
- Dust-proof ball bearings for long service life of the machine

### System components

Accessories → 344, 357

Extraction systems → 453



**For high-gloss surfaces**  
Thanks to the soft start and small orbit diameter (2.5 mm), the SXE 150-2.5 is the favourite for high-grade sanding results for high-gloss surfaces and their preparation.



**For coarse and fine sanding**  
The SXE 450 TurboTec has a removable side handle for variable handle positions and an adjustable orbit diameter for coarse and fine finishing.



**Small, light and compact**  
SXE 150-2.5 BL and SXE 150-5.0 BL are the ideal solution for ergonomic working in continuous mode.



Technical data	Random Orbital Sander SXE 3125	Random Orbital Sander SXE 3150	TurboTec Random Orbital Sander SXE 425	TurboTec Random Orbital Sander SXE 450
Diameter of backing pad	125 mm	150 mm	125 mm	150 mm
No-load speed	4,000 - 12,000 /min	4,000 - 12,000 /min	4,200 - 11,000 /min	4,200 - 11,000 /min
Rated input power	310 W	310 W	320 W	350 W
Revolutions at rated load	8,800 /min	8,400 /min	9,000 /min	8,500 /min
Orbit diameter	3 mm	3 mm	5 mm	2.8/6.2 mm
Weight (without mains cable)	1.5 kg	1.6 kg	2.3 kg	2.4 kg
Cable length	4 m	4 m	4 m	4 m

Scope of delivery

Order no.	600443	600444	600131	600129 <sup>1) 2)</sup>
Sanding pad »multi-hole« with hook and loop	■	■	■	■
removable side handle			■	■
Hexagonal wrench	■	■	■	■
Textile dust bags	■	■	■	■
Plastic carry case	■	■	■	
MetaLoc case				■

Equipment variants can be found in the Metabo price list and on the internet

<sup>1)</sup> also available in 120 V (North/Latin America)

<sup>2)</sup> also available in 110 V (UK)

Product advantages

- Patented adjustable "Duo" oscillating circuit setting: Can be set depending on the application for fine sanding or high stock removal
- Lightweight, handy sander with perfect ergonomics
- Low-vibration working thanks to smooth running operation
- Thumbwheel for speed preselection
- Turbo boost: allows additional power reserves to be employed for maximum removal
- Power Control System: No scratches when placing the machine directly onto the material at speed
- Removable side handle
- Dust-proof ball bearings for long service life of the machine
- Variospeed (V) Electronics for working at customised speeds to suit various application materials
- Grip area with non-slip soft-grip surface
- Sturdy aluminium die cast bearing housing
- Easy to empty textile dust bag for working without extraction facilities
- Extraction possibility by means of connecting an all-purpose vacuum cleaner
- Multi-hole sanding pad for effective extraction and a longer service life of the sanding medium

System components

Accessories → 344, 357

Extraction systems → 453



Technical data	Random Orbital Sander SXE 150-2.5 BL	Random Orbital Sander SXE 150-5.0 BL
Diameter of backing pad	150 mm	150 mm
No-load speed	4,000 - 10,000 /min	4,000 - 10,000 /min
Rated input power	350 W	350 W
Revolutions at rated load	10,000 /min	10,000 /min
Orbit diameter	2.5 mm	5 mm
Weight (without mains cable)	1 kg	1 kg
Cable length	4.3 m	4.3 m

Scope of delivery

Order no.	615025	615050
Sanding pad »multi-hole« with hook and loop	■	■
Open-jawed spanner	■	■
MetaLoc case	■	■

Equipment variants can be found in the Metabo price list and on the internet

Product advantages

- Orbit diameter 2.5 mm for highest surface quality with good material removal
- Orbit diameter 5 mm for maximum material removal with good surface quality
- Extremely light and flat random orbital sander with symmetrical design for easy change of hands or operation with two hands
- Non-slip paddle switch with dead man function for safe starting and optionally also control of the speed
- Vario Tacho Constamatic (VTC) Full-wave Electronics for grinding with materials requiring customised speeds, which remain constant under load
- Electronic presetting of the desired speed range
- Soft start minimises surface damage when placing the machine on the work surface
- Unique Metabo brushless motor highest efficiency when grinding, also in continuous mode
- Low vibrations for convenient continuous mode
- Overload protection: protects the motor from overheating
- Separate main switch protects from unintentional start
- Motor and plate brake permits quick placing down of the machine after use
- Extraction possibility by means of connecting an all-purpose vacuum cleaner
- Multi-hole sanding pad for effective extraction and a longer service life of the sanding medium
- For working with 125 mm sanding sheets, the sanding pad »multi-hole« Ø 125 mm can be used (accessory 630264000)
- Service-friendly with exchangeable cable

System components

Accessories → 344

Extraction systems → 453

## Orbital Sanders: Quiet operation, perfect sanding result.

Using Metabo orbital sanders you will always achieve a clean, sanding result without scoring marks and grooves, for example, when sanding varnished and wooden surfaces of door frames, staircases or flat workpieces. The innovative oscillating system and the smooth operation guarantee an excellent finished result. Even heat-sensitive materials such as varnish can be processed with the Metabo orbital sanders thanks to standard speed selection.



SRE 4351 Turbo Tec



**Excellent sanding result**  
without scoring marks and grooves, for a professional surface finish.



**Sanding near edges**  
When sanding near edges the vibration damped handle can be removed quickly without the need for tools. Perfect grinding result down to the smallest corner.



**Universal clamping system**  
Universal clamping system for the use of sanding sheets with or without hook and loop, as well as sanding media up to a thickness of 10 mm.



### Technical data

Sanding plate	114 x 102 mm
Orbital frequency with no load	26,000 /min
Rated input power	200 W
Output power	80 W
Orbital frequency at rated load	22,000 /min
Orbit diameter	1.4 mm
Weight (without mains cable)	1.3 kg
Cable length	2.8 m

### Palm Grip Orbital Sander FSR 200 Intec

### Scope of delivery

Order no.	600066 <sup>1)</sup>
Hole punch	■
Dust collection cartridge	■
1 Pleated filter	■
Plastic carry case	■

<sup>1)</sup> also available in 120 V (North/Latin America)

### Product advantages

- Light and handy machine for convenient one-hand operation
- Very good weight/performance ratio, ideal for working overhead
- Grip area with non-slip soft-grip surface
- Dust-proof ball bearings for long service life of the machine
- Robust clamping system for sanding paper with or without hook and loop fastener
- Dust collector cartridge with filter for working without connecting to a vacuum cleaner
- Extraction possibility by means of connecting to an all-purpose vacuum cleaner via an adapter (accessory)

### System components

Accessories → 351, 357

Extraction systems → 453



Technical data	Orbital Sander SR 2185	Orbital Sander SRE 3185	Orbital Sander SRE 4350 TurboTec	Orbital Sander SRE 4351 TurboTec
Sanding plate	92 x 184 mm	92 x 184 mm	92 x 184 mm	114 x 229 mm
Orbital frequency with no load	22,300 /min	8,800 - 22,300 /min	8,400 - 22,000 /min	8,400 - 22,000 /min
Rated input power	210 W	210 W	350 W	350 W
Output power	80 W	80 W	180 W	180 W
Orbital frequency at rated load	20,400 /min	20,400 /min	17,000 /min	17,000 /min
Orbit diameter	2 mm	2 mm	2.2 mm	2.2 mm
Weight (without mains cable)	1.5 kg	1.5 kg	2.5 kg	2.7 kg
Cable length	2.5 m	4 m	4 m	4 m

Scope of delivery

Order no.	600441 <sup>1)</sup>	600442	611350	611351 <sup>1),2)</sup>
Hook and loop grinding plate			■	■
removable side handle			■	■
Textile dust bags	■	■	■	■
Plastic carry case	■	■		
MetaLoc case			■	■

Equipment variants can be found in the Metabo price list and on the internet  
<sup>1)</sup> also available in 120 V (North/Latin America)  
<sup>2)</sup> also available in 110 V (UK)

Product advantages

- Lightweight, handy sander with perfect ergonomics
- Grip area with non-slip soft-grip surface
- Low-vibration working thanks to smooth running operation
- Robust aluminium die cast bearing flange
- Robust clamping system for sanding paper with or without hook and loop fastener
- Oscillating system with double-row angular ball bearing for extremely smooth running and minimum vibration
- Robust clamping system for sanding paper with or without hook and loop fastener, as well as sanding medium up to 10 mm in thickness
- Ball bearing with multiple seals and tear-proof rubber sleeve protects the machine against aggressive dust
- Side handle with vibration damping for a comfortable grip in any work position
- Turbo boost: allows additional power reserves to be employed for maximum removal
- Sanding plate with additional lateral extraction channels for cleaner working
- Vario (V)-Electronics for working at customised orbital frequencies to suit various application materials
- Excellent grinding finish without scoring marks and grooves, for a professional surface finish
- Easy to empty textile dust bag for working without extraction facilities
- Extraction possibility by means of connecting an all-purpose vacuum cleaner

System components

Accessories → 351, 357 | Extraction systems → 453

Technical data	Intec Multi Sander FMS 200
Sanding plate	100 x 147 mm
Orbital frequency with no load	26,000 /min
Rated input power	200 W
Output power	80 W
Orbital frequency at rated load	22,000 /min
Orbit diameter	1.4 mm
Weight (without mains cable)	1.2 kg
Cable length	2.8 m

Scope of delivery

Order no.	600065
Dust collection cartridge	■
1 Pleated filter	■
Plastic carry case	■

Product advantages

- Triangular base plate for sanding edges, corners and surfaces
- Light and handy machine for convenient one-hand operation
- Very good weight/performance ratio for low-fatigue working
- Grip area with non-slip soft-grip surface
- Dust collector cartridge with filter for working without connecting to a vacuum cleaner
- Extraction possibility by means of connecting to an all-purpose vacuum cleaner via an adapter (accessory)

System components

Accessories → 354, 357 | Extraction systems → 453

Technical data	Triangular Base-Plate Sander DSE 300 Intec
Base plate, measurement from corner to corner	93 mm
Orbital frequency with no load	14,000 - 22,000 /min
Orbital frequency at rated load	18,000 /min
Rated input power	300 W
Orbit diameter	1.8 mm
Weight (without mains cable)	1.3 kg
Cable length	4 m

Scope of delivery

Order no.	600311
Hexagonal wrench	■
Plastic carry case	■

Product advantages

- For effective sanding of edges and corners
- Patented, rotating base plate for optimum utilisation of the edges of the sanding paper
- Dust-proof ball bearings for long service life of the machine
- Robust oscillation sleeve and base plate holder made from die-cast aluminium for a long service life
- Vario (V)-Electronics for working at customised orbital frequencies to suit various application materials
- Thumbwheel for preselection of the orbital frequency
- Easy change of sanding sheet with hook and loop base-plate
- Dust collector cartridge with filter for working without connecting to a vacuum cleaner
- Convenient handling thanks to slim design
- Compact design aids access when working in difficult to reach areas
- Extraction possibility by means of connecting to an all-purpose vacuum cleaner via an adapter (accessory)

System components

Accessories → 354, 357 | Extraction systems → 453

01  
02  
03  
04  
05  
06  
07  
08  
09  
10  
11  
12  
13  
14  
15



Technical data	Belt Sander BAE 75
Torque	12 Nm
Sanding Belt	75 x 533 mm
Sanding belt support surface	85 x 150 mm
Belt speed in idle	240 - 450 m/min
Rated input power	1,010 W
Weight (without mains cable)	4.9 kg
Cable length	4 m

#### Scope of delivery

Order no.	600375
Dust bag	■
Side handle	■
Hexagonal wrench	■
Suction adapter	■
Length guide	■
Machine stand	■

#### Product advantages

- Excellent sanding results thanks to powerful motor and precise belt path
- Fast and tool-free sanding belt change
- Vario-Tacho-Constamatic (VTC)-Full Wave Electronics for working at customised speeds to suit the application material and belt speeds that remain almost constant, even under load
- Thumbwheel for preselection of belt speed
- With antistatic dust bag for working without connecting a vacuum cleaner
- Side handle for ideal machine guidance
- With machine stand for tool-free conversion to stationary use in a matter of seconds
- With length guide for exact guidance of the workpiece in stationary use
- Extraction possibility by means of connecting an all-purpose vacuum cleaner

#### System components

Accessories → 359

Extraction systems → 453

## Abrasive media: High removal and durable.

Proven quality for professional use: for processing surfaces like wood, metal, paint, stone.  
Also suitable for sanders of all common makes.

### Structure and purpose

#### The sanding compound

carries the grains and transfers the chip removal forces. Besides high strength and small expansion, the sanding compound has to render a sanding process matching flexibility

Carriers are

- Highly compressed papers of various thicknesses.
- Fabric based on polyester and cotton of various strengths.
- Vulcanized fibre as a strong and tear-proof base is the base material for the (Vulcan) fibre disc.

#### The abrasive grain

is the actual cutting tool. It penetrates the material being processed and removes the surface. The abrasive grain is anchored on to the grain-holding medium. High hardness, toughness and a sharp edged geometry are the most important attributes of the abrasive grain.

Abrasive grain types are

- Corundum (aluminium oxide) as a hard, slightly brittle grain for the processing of metal, wood, varnish, etc.
- Silicon carbide as a hard, sharp-edged abrasive grain for the processing of lacquer, wood, ceramic, glass and rubber etc.
- Aluminium zirconia as a tough and fine crystalline combination of aluminium oxide and aluminium zircon for the processing of metal and non-rusting materials.

#### The bonding agent

anchors the abrasive grain in the sanding compound carrier and supports it against the forces generated by the removal of the surface.

Bonding agents are

- Phenolic resins and partially synthetic resins for sufficient support

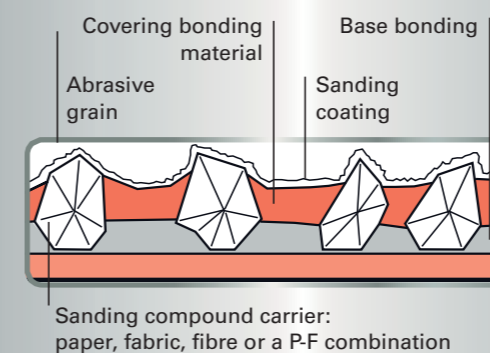

### The quality of Metabo sanding media

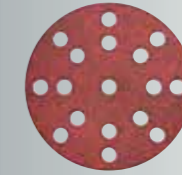

e.g. for random orbital sanders:

**Wood + metal »professional«**

**E-paper, pink aluminium oxide, resin bonded**

- High-quality sanding paper with high coarseness and high removal of material
- For best results when sanding wood and metal for professional use

#### Application:

For veneers, solid wood, polyester, steel and stainless steel sheets, non-ferrous metals, light alloys



For example, for orbital sanders:

**Wood »classic«**

**A/B paper, aluminium oxide, resin/glue bond**

- High-quality sanding paper with semi-open coarseness

#### Application:

For wood generally, solid wood, veneers, plastic, acrylic glass, lacquer, spatula, fillers, e.g. for deburring, cleaning of plywood, veneer, solid wood, lacquered surfaces, deburring of veneered furniture edges



For example, for triangular base-plate sanders:

**Paint »professional«**

**B/C paper, pink grade corundum, stearate-coated, resin bonded**

- High-quality sanding paper with semi-open coarseness and high removal of material
- The special stearate coating ensures a long service life by not clogging the sanding medium

#### Application:

For best results when sanding off paint, lacquer, body-filler on wood or metal on professional application

Backing Pads and Intermediate Discs

Hook and loop backing pads					
	Diameter mm	Hardness	Version	Suitable for	Order no.
	80	Medium-hard	Perforated	SX E 400	624064000*
	122	medium	Perforated	FSX 200 Intec	625658000*
	122	Medium-hard	Perforated	SX E 125	631224000*
	125	Soft	Perforated	SXE 325 Intec, SX E 425, SXE 425 TurboTec	631220000*
	125	Medium-hard	Perforated	SXE 325 Intec, SX E 425, SXE 425 TurboTec	631219000*
	125	Medium-hard	Perforated	SXE 3125	624739000*
	150	Soft	Perforated (6 holes)	SXE 450 TurboTec	631156000*
	150	Medium-hard	Perforated (6 holes)	SX E 450 Duo	631158000*
	150	Medium-hard	Perforated (6 or 8 holes)	SXE 450 TurboTec	631150000*
	125	Medium-hard	multi-hole	SXE 150-2.5 BL, SXE 150-5.0 BL	630264000*
	150	Medium-hard	multi-hole	SXE 150-2.5 BL, SXE 150-5.0 BL	630259000*

	Diameter mm	Hardness	Version	Suitable for	Order no.
	125	Medium-hard	multi-hole	SXE 425 TurboTec, SXE 3125	630261000*
	150	Medium-hard	multi-hole	SXE 450 TurboTec, SXE 3150	630262000*
	150	Medium-hard	Perforated (6 or 8 holes)	SXE 3150	624740000*

Backing pad, for self-adhesive sanding sheets

- Perforated backing pad, medium-hard version
- For attaching self-adhesive sanding sheets directly on the backing pad

	Diameter mm	Hardness	Version	Suitable for	Order no.
	150	medium	Perforated (6 holes)	SXE 3150, SX E 450 Duo, SXE 450 TurboTec, SXE 3150	631169000*

Hook and loop intermediate discs

- Hook and loop intermediate disc for particularly soft delicate working, for sanding of curved surfaces and contours, as damping element between sanding paper and sanding pad



	Diameter mm	Hardness	Version	Suitable for	Order no.
	80	Soft	Perforated	SX E 400	624061000*
	125	Soft	Unperforated	SX E 425, SXE 325 Intec, FSX 200 Intec, SXE 425 TurboTec, SXE 3125	631216000*
	150	Soft	Unperforated	SXE 3150, SX E 450 Duo, SXE 450 TurboTec, SXE 3150	624037000*
	150	Soft	multi-hole	SXE 150-2.5 BL, SXE 150-5.0 BL	630260000*
	125	Soft	multi-hole	SXE 150-2.5 BL, SXE 150-5.0 BL	630263000*



\*Self-service packaging

### Hook and Loop Sanding Sheets for Random Orbital Sanders

#### Hook and loop sanding sheets for wood and metal, »professional« series

- High-quality sanding paper with semi-open coarseness and high removal of material for a homogenous finish
- For veneers, solid wood, polyester, steel and stainless steel sheets, non-ferrous metals, light alloys
- e.g. for sanding veneered cabinet fronts and sides, sanding furniture covered with liners with hot-melt type adhesive edges, decorative sanding of stainless steel sheets, sanding-based repair work, and deburring cut sheet metal





Diameter mm	Grit	Sales unit	Order no.
<b>Hook and loop sanding sheets Ø 80 mm, 6 holes</b>			
			
80	P 40	10	624041000*
80	P 60	10	624042000*
80	P 80	10	624043000*
80	P 100	10	624044000*
80	P 120	10	624045000*
80	P 180	10	624046000*
80	P 240	10	624047000*
80	P 320	10	624048000*
80	P 40	25	624051000
80	P 60	25	624052000
80	P 80	25	624053000
80	P 100	25	624054000
80	P 120	25	624055000
80	P 180	25	624056000
80	P 240	25	624057000
80	P 320	25	624058000
80	P 400	25	624059000
<b>Hook and loop sanding sheets Ø 125 mm, 8 holes</b>			
			
125	P 40	5	631226000*
125	P 60	5	631227000*
125	P 80	5	631228000*
125	P 120	5	631229000*
125	P 180	5	631230000*
125	P 240	5	631231000*
125	P 320	5	631236000*
125	P 40	25	631584000
125	P 60	25	631585000
125	P 80	25	631586000
125	P 120	25	631587000
125	P 180	25	631588000
125	P 240	25	631589000
125	P 320	25	631596000
125	P 400	25	631597000
<b>Hook and loop sanding sheets Ø 125 mm, »multi-hole«</b>			
			
125	P 40	50	626848000
125	P 60	50	626849000
125	P 80	50	626850000
125	P 100	50	626851000
125	P 120	50	626852000

Diameter mm	Grit	Sales unit	Order no.
125	P 180	50	626853000
125	P 240	50	626854000
125	P 320	50	626855000
125	P 400	50	626856000
<b>Hook and loop sanding sheets Ø 150 mm, 6 holes</b>			
			
150	P 40	5	624001000*
150	P 60	5	624002000*
150	P 80	5	624003000*
150	P 100	5	624004000*
150	P 120	5	624005000*
150	P 180	5	624006000*
150	P 240	5	624007000*
150	P 320	5	624008000*
150	P 40	25	624019000
150	P 60	25	624020000
150	P 80	25	624021000
150	P 100	25	624022000
150	P 120	25	624023000
150	P 180	25	624024000
150	P 240	25	624025000
150	P 320	25	624026000
150	P 400	25	624027000
<b>Hook and loop sanding sheets Ø 150 mm, »multi-hole«</b>			
			
150	P 40	50	626674000
150	P 60	50	626675000
150	P 80	50	626676000
150	P 100	50	626677000
150	P 120	50	626678000
150	P 180	50	626679000
150	P 240	50	626680000
150	P 320	50	626681000
150	P 400	50	626682000

\*Self-service packaging

Hook and loop sanding sheets for paints and lacquers, »professional« series

- High-quality sanding paper with semi-open coarseness and high removal of material
- Suitable for working with paints and lacquers of all types and filler compounds
- e.g. for deburring, cleaning veneers, solid woods, plywood, and lacquers, deburring furniture veneer



Diameter mm	Grit	Sales unit	Order no.
<b>Hook and loop sanding sheets Ø 80 mm, 6 holes</b>			
			
80	P 40	25	624081000
80	P 60	25	624082000
80	P 80	25	624083000
80	P 100	25	624084000
80	P 120	25	624085000
80	P 180	25	624086000
80	P 240	25	624087000
80	P 320	25	624088000
80	P 400	25	624089000
<b>Hook and loop sanding sheets Ø 125 mm, 8 holes</b>			
			
125	P 40	25	625726000
125	P 60	25	625727000
125	P 80	25	625728000
125	P 100	25	625729000
125	P 120	25	625730000
125	P 180	25	625731000
125	P 240	25	625732000
125	P 320	25	625733000
125	P 400	25	625734000
<b>Hook and loop sanding sheets Ø 125 mm, »multi-hole«</b>			
			
125	P 40	50	626857000
125	P 60	50	626858000
125	P 80	50	626859000
125	P 100	50	626860000
125	P 120	50	626861000
125	P 180	50	626862000
125	P 240	50	626863000
125	P 320	50	626864000
125	P 400	50	626865000
<b>Hook and loop sanding sheets Ø 150 mm, 6 holes</b>			
			
150	P 40	25	624028000
150	P 60	25	624029000
150	P 80	25	624030000
150	P 100	25	624031000
150	P 120	25	624032000
150	P 180	25	624033000
150	P 240	25	624034000
150	P 320	25	624035000
150	P 400	25	624036000

Diameter mm	Grit	Sales unit	Order no.
<b>Hook and loop sanding sheets Ø 150 mm, »multi-hole«</b>			
			
150	P 40	50	626683000
150	P 60	50	626684000
150	P 80	50	626685000
150	P 100	50	626686000
150	P 120	50	626687000
150	P 180	50	626688000
150	P 240	50	626689000
150	P 320	50	626690000
150	P 400	50	626691000

Sanding Sheet Assortments

Assortments of sanding sheets for wood and metal, »professional« series

- Corundum
- For wood, metal and painted surfaces

	Order no.
 <b>25 Hook and loop sanding sheets</b> Assortment (10 x P 60, 10 x P 80, 5 x P 120) Diameter: 80 mm Version: perforated (6 holes) Sales unit: 25	624060000
 <b>6 Hook and loop sanding sheets</b> Assortment (2 x P 60, 2 x P 120, 2 x P 240) Diameter: 125 mm Version: perforated (8 holes) Sales unit: 6	631232000*
 <b>25 Hook and loop sanding sheets</b> Assortment (10 x P 60, 10 x P 80, 5 x P 120) Diameter: 125 mm Version: perforated (8 holes) Sales unit: 25	631583000
 <b>25 Hook and loop sanding sheets</b> Assortment (10 x P 60, 10 x P 80, 5 x P 120) Diameter: 150 mm Version: perforated (6 holes) Sales unit: 25	624066000*
 <b>Metaloc sanding media set »multi-hole«</b> Metaloc includes 50 x P 80 (626676000), 50 x P 120 (626678000), 50 x P 180 (626679000) Diameter: 150 mm Version: multi-hole Sales unit: 150	626756000

Sanding sheet assortments for paints and lacquers, »professional« series

	Order no.
 <b>Metaloc sanding media set »multi-hole«</b> ■ Corundum abrasive, stearate-coated ■ For metal, filler compound, paints, filler Metaloc includes 50 x P 80 (626685000), 50 x P 120 (626687000), 50 x P 180 (626688000) Diameter: 150 mm Version: multi-hole Sales unit: 150	626755000

\*Self-service packaging



Hook and loop polishing sponges



- For high-gloss polishing of slightly soiled, scratched surfaces. For use with polish on curved and even surfaces.

Diameter mm	Thickness mm	Sales unit	Order no.
80	20	1	624092000*
130	20	1	631222000*
160	20	1	631233000*

Hook and loop lambswool polishing discs



- For high-gloss polishing

Diameter mm	Sales unit	Order no.
85	1	624063000*
160	1	631217000*
130	1	631223000*

Sanding Sheets for Orbital Sanders

Sanding sheets wood and metal, »professional« series

- High-quality sanding paper with semi-open coarseness and high removal of material
- For veneers, solid wood, polyester, steel and stainless steel sheets, non-ferrous metals, light alloys
- For sanding veneered cabinet fronts and sides, sanding furniture covered with liners with hot-melt type adhesive edges, decorative sanding of stainless steel sheets, sanding-based repair work, and deburring cut sheet metal etc.

Dimensions mm	Grit	Sales unit	Order no.
<b>Hook and loop sanding sheets 93 x 185 mm, 8 holes, with hook and loop</b>			
93 x 185	P 40	10	625765000*
93 x 185	P 60	10	625766000*
93 x 185	P 80	10	625767000*
93 x 185	P 100	10	625768000*
93 x 185	P 120	10	625769000*
93 x 185	P 180	10	625770000*
93 x 185	P 240	10	625771000*
<b>Sanding sheets 93 x 230 mm, 8 holes, for clamping</b>			
93 x 230	P 40	10	624480000*
93 x 230	P 60	10	624481000*
93 x 230	P 80	10	624482000*
93 x 230	P 100	10	624483000*
93 x 230	P 120	10	624484000*
93 x 230	P 180	10	624485000*
93 x 230	P 240	10	624486000*
<b>Hook and loop sanding sheets 103 x 115 mm, 6 holes, with hook and loop</b>			
103 x 115	P 40	10	625619000*
103 x 115	P 60	10	625620000*
103 x 115	P 80	10	625621000*
103 x 115	P 100	10	625622000*
103 x 115	P 120	10	625623000*
103 x 115	P 180	10	625624000*
103 x 115	P 240	10	625625000*
<b>Hook and loop sanding sheets 115 x 230 mm, 14 holes, with hook and loop</b>			
115 x 230	P 40	10	625786000*
115 x 230	P 60	10	625787000*
115 x 230	P 80	10	625788000*
115 x 230	P 100	10	625789000*
115 x 230	P 120	10	625790000*
115 x 230	P 180	10	625791000*
115 x 230	P 240	10	625792000*
115 x 230	P 320	10	625793000*
<b>Sanding sheets 115 x 280 mm, 14 holes, for clamping</b>			
115 x 280	P 40	10	624491000*
115 x 280	P 60	10	624492000*
115 x 280	P 80	10	624493000*
115 x 280	P 100	10	624494000*
115 x 280	P 120	10	624495000*
115 x 280	P 180	10	624496000*
115 x 280	P 240	10	624497000*

\*Self-service packaging



Sanding sheets for wood, »classic« series

- High-quality sanding paper with semi-open coarseness
- For all woods, solid wood, veneers, plastics, acrylics, lacquers, putty, filling compounds
- For deburring, cleaning of plywood, veneers, solid woods, lacquers and deburring furniture veneer etc.

Dimensions mm	Grit	Sales unit	Order no.
 Sanding sheets 93 x 230 mm, 8 holes, for clamping			
93 x 230	P 40	10	624826000*
93 x 230	P 60	10	624827000*
93 x 230	P 80	10	624828000*
93 x 230	P 100	10	624829000*
93 x 230	P 120	10	624830000*
93 x 230	P 180	10	624831000*
93 x 230	P 240	10	624832000*

Sanding sheets for paints and lacquers, »professional« series



- High-quality sanding paper with semi-open coarseness and high removal of material
- Suitable for working with paints and lacquers of all types and filler compounds
- For deburring, cleaning of plywood, veneers, solid woods, lacquers and deburring furniture veneer etc.

Dimensions mm	Grit	Sales unit	Order no.
 Hook and loop sanding sheets 93 x 185 mm, 8 holes, with hook and loop			
93 x 185	P 40	25	625881000
93 x 185	P 60	25	625882000
93 x 185	P 80	25	625883000
93 x 185	P 100	25	625884000
93 x 185	P 120	25	625885000
93 x 185	P 180	25	625886000
93 x 185	P 240	25	625887000
93 x 185	P 320	25	625888000
 Hook and loop sanding sheets 103 x 115 mm, 6 holes, with hook and loop			
103 x 115	P 80	10	625641000*
103 x 115	P 120	10	625643000*
103 x 115	P 180	10	625644000*
103 x 115	P 240	10	625645000*
103 x 115	P 320	10	625646000*
 Hook and loop sanding sheets 115 x 230 mm, 14 holes, with hook and loop			
115 x 230	P 40	25	625891000
115 x 230	P 60	25	625892000
115 x 230	P 80	25	625893000
115 x 230	P 100	25	625894000
115 x 230	P 120	25	625895000
115 x 230	P 180	25	625896000
115 x 230	P 240	25	625897000
115 x 230	P 320	25	625898000

\*Self-service packaging

Sanding Sheet Assortments

Assortment of sanding sheets for wood and metal, »professional« series

	Order no.
 <b>10 Sanding sheets</b> Assortment (2 each of P 40, P 80, P 120, P 180 and P 240) Dimensions: 93 x 230 mm Version: perforated (8 holes)	624490000*
 <b>10 Hook and loop sanding sheets</b> Assortment (2 each of P 40, P 80, P 120, P 180 and P 240) Dimensions: 93 x 185 mm Version: perforated (8 holes)	625774000*
 <b>10 Hook and loop sanding sheets</b> Assortment (2 each of P 40, P 80, P 120, P 180 and P 240) Dimensions: 115 x 230 mm Version: perforated (14 holes)	625795000*

Nylon Webs



- Suitable for sanding, roughing, cleaning, degreasing and matting of wooden materials, paints, lacquers and metals, as well as to produce decorative surfaces.

Dimensions mm	Grit	Sales unit	Order no.
93 x 250	Coarse	5	624723000*
93 x 250	medium	5	624722000*
93 x 250	Very fine	5	624721000*
115 x 295	Coarse	5	624727000*
115 x 295	medium	5	624726000*
115 x 295	Very fine	5	624725000*

Abrasive Mesh









- Particularly suited for sanding gypsum plaster and plasterboard.

Dimensions mm	Grit	Sales unit	Order no.
93 x 250	P 120	5	624724000*
115 x 295	P 120	5	624728000*

Additional Accessories for Sanders

Perforated hook and loop sanding pads

	Order no.
 <b>Sanding plate 92 x 184 mm</b> ■ Perforated, hook and loop sanding pads for SR 2185 / SRE 3185 (as spare)	624729000*
 <b>Sanding plate 92 x 190 mm</b> ■ The sanding pad of orbital sanders Sr 356/Sr E 357 can be replaced by the hook and loop base-plate	624736000*
 <b>Sanding plate 112 x 230 mm</b> ■ Perforated, hook and loop sanding pad for SRE 4351 TurboTec (as spare)	624737000*
 <b>Sanding plate 93 x 185 mm</b> ■ Perforated, hook and loop sanding pad for SRE 4350 TurboTec (as spare)	624738000*
 <b>Sanding plate 112 x 236 mm</b> ■ The sanding pad of orbital sanders Sr 358/Sr E 359 can be replaced by the hook and loop sanding pad	624749000*
 <b>Sanding plate perforated 112 x 144 mm</b> ■ Perforated, hook and loop sanding pad FSR 200 Intec (as spare)	625657000*

### Sanding Pads with Hook and Loop

	Order no.
 <p><b>Sanding pad, perforated</b> Sanding pad for FMS 200 Intec (as spare) Dimensions: 147 x 100 mm</p>	62560000*

### Hook and Loop Sanding Sheets for Multi Sanders

#### Hook and loop sanding sheets for wood, »classic« series

- High-quality sanding paper with semi-open coarseness
- For all woods, solid wood, veneers, plastics, acrylics, lacquers, putty, filling compounds
- For deburring, cleaning of plywood, veneers, solid woods, lacquers and deburring furniture veneer etc.

Dimensions mm	Grit	Sales unit	Order no.
 <p><b>Hook and loop sanding sheets 100 x 150 mm, 11 holes, 2 pieces</b></p>			
100 x 150	P 40	10	625603000*
100 x 150	P 60	10	625604000*
100 x 150	P 80	10	625605000*
100 x 150	P 100	10	625606000*
100 x 150	P 120	10	625607000*
100 x 150	P 180	10	625608000*
100 x 150	P 240	10	625609000*
Assortment (2 each of P 60, P 80, P 120, P 180 and P 240)			625610000*

#### Hook and loop sanding sheets for paints and lacquers, »professional« series

- High-quality sanding paper with semi-open coarseness and high removal of material
- Suitable for working with paints and lacquers of all types and filler compounds
- For deburring, cleaning veneers, solid woods, plywood, lacquers and deburring furniture veneer etc.

Dimensions mm	Grit	Sales unit	Order no.
 <p><b>Hook and loop sanding sheets 100 x 150 mm, 11 holes, 2 pieces</b></p>			
100 x 150	P 40	10	625611000*
100 x 150	P 60	10	625612000*
100 x 150	P 80	10	625613000*
100 x 150	P 100	10	625614000*
100 x 150	P 120	10	625615000*
100 x 150	P 180	10	625616000*
100 x 150	P 240	10	625617000*
Assortment (2 each of P 40, P 80, P 120, P 180 and P 240)			625618000*

\*Self-service packaging

### Base Plates

#### Perforated hook and loop sanding pads

	Order no.
 <p><b>Perforated hook and loop sanding pad</b> For the triangular base-plate sanders DS E 170 and DS E 180 (as spare) Dimension from corner to corner: 93 mm</p>	624970000*
 <p><b>Perforated hook and loop sanding pad</b> For the triangular base-plate sanders DSE 280, DSE 300 and DSE 300 Intec (as spare) Dimension from corner to corner: 90 mm</p>	624992000*

#### Special lamellar base-plate

	Order no.
 <p><b>Special lamellar base-plate</b> For triangular base-plate sander DSE 170/ 180/ 280/300. Hook and loop at the bottom side. The self-adhesive hook and loop liner supplied can be fitted to the top of this base-plate so that hook and loop sanding sheets can be fitted for top and bottom sanding of louvres.</p>	624971000*

#### Self-adhesive hook and loop liner

	Order no.
 <p><b>Self-adhesive liner</b> Self-adhesive hook and loop liner (as spare for special lamellar base-plate 624971000)</p>	624972000*

### Hook and Loop Sanding Sheets for Triangular Base Plate Sanders and Multi-Tool

#### Hook and loop sanding sheets for wood and metal, »professional« series

- High-quality sanding paper with semi-open coarseness and high removal of material for a homogenous finish
- For veneers, solid wood, polyester, steel and stainless steel sheets, non-ferrous metals, light alloys
- For sanding veneered cabinet fronts and sides, sanding furniture covered with veneers with hot-melt type adhesive edges, decorative sanding of stainless steel sheets, sanding-based repair work, and deburring cut sheet metal

Dimensions mm	Grit	Sales unit	Order no.
 <p><b>Hook and loop sanding sheets 93 x 93 mm, 6 holes</b></p>			
93 x 93	P 40	5	624940000*
93 x 93	P 60	5	624941000*
93 x 93	P 80	5	624942000*
93 x 93	P 100	5	624943000*
93 x 93	P 120	5	624944000*
93 x 93	P 180	5	624945000*
93 x 93	P 240	5	624946000*
93 x 93	P 320	5	624947000*
93 x 93	P 40	25	624980000
93 x 93	P 60	25	624981000

Dimensions mm	Grit	Sales unit	Order no.
93 x 93	P 80	25	624982000
93 x 93	P 100	25	624983000
93 x 93	P 120	25	624984000
93 x 93	P 180	25	624985000
93 x 93	P 240	25	624986000
93 x 93	P 320	25	624987000
Assortment (10 x P 60, 10 x P 80, 5 x P 120)			624988000

Hook and loop sanding sheets for paints and lacquers, »professional« series

- High-quality sanding paper with semi-open coarseness and high removal of material
- Suitable for working with paints and lacquers of all types and filler compounds
- For deburring, cleaning veneers, solid woods, plywood, and lacquers, deburring furniture veneer

Dimensions mm	Grit	Sales unit	Order no.
<b>Hook and loop sanding sheets 93 x 93 mm, 6 holes</b>			
			
93 x 93	P 40	25	625681000
93 x 93	P 60	25	625682000
93 x 93	P 80	25	625683000
93 x 93	P 100	25	625684000
93 x 93	P 120	25	625685000
93 x 93	P 180	25	625686000
93 x 93	P 240	25	625687000
93 x 93	P 320	25	625688000



Hook and Loop Abrasive Nylon Web, Corundum Abrasive



- Used for structuring wood (applying a rustic appearance), for removing rust from metal and for sanding paints (tarnishing)

Grit	Order no.
P 100	624958000*
P 280	624959000*

Accessories for Dust Extraction

	Order no.
 <b>10 Dust filters</b> For the dust collector cartridge 624993000 of the DSE 300 Intec and the DSE 280 Intec	624995000*
 <b>Extraction nozzles</b> ■ For external dust extraction for the DSE 300/ DSE 300 Intec and the DSE 280 Intec	624994000*
 <b>Adapter 30/35 mm</b> ■ For connecting the suction hose with connector Ø 35 mm to an extraction nozzle Ø 30 mm	624996000

Dust bag holders



**Dust bag holder, complete**  
As spare, with 1 dust bag  
suitable for orbital sanders / multi sanders: Sr 356, Sr E 357, Sr 358, Sr E 359  
suitable for random orbital sanders: SX E 425, SX E 425 XL, SX E 450 Duo

Order no.

631289000\*

Dust bags (paper)



**Dust bag**  
Without dust bag holder 631385000, as spare, pack of 5  
suitable for orbital sanders / multi sanders: Sr 226, Sr E 227, Sr 216, Sr E 217, Sr 326, Sr E 327, Sr 328, Sr E 329  
suitable for random orbital sanders: SX E 125

Order no.

631286000\*



**Dust bag**  
Without dust bag holder 631289000, as spare, pack of 5  
suitable for orbital sanders / multi sanders: Sr 356, Sr E 357, Sr 358, Sr E 359  
suitable for random orbital sanders: SX E 425, SX E 425 XL, SX E 450 Duo

Order no.

631288000\*

Dust bags



**Textile dust bag**  
With connector, for the Metabo orbital sanders with dust extraction.  
Can be used in place of the dust bag holder supplied  
suitable for orbital sanders / multi sanders: Sr 226, Sr E 227, Sr 216, Sr E 217, Sr 326, Sr E 327, Sr 328, Sr E 329  
suitable for random orbital sanders: SX E 125

Order no.

631235000\*



**Textile dust bags**  
Easy to empty textile dust bag for working without extraction facilities  
suitable for orbital sanders / multi sanders: SR 2185, SRE 3185  
suitable for random orbital sanders: SXE 3125, SXE 3150

Order no.





631287000\*





**Textile dust bag**  
Can be used in the dust bag holder (631288000) instead of the paper dust bag provided (631289000)  
suitable for orbital sanders / multi sanders: Sr 356, Sr E 357, Sr 358, Sr E 359  
suitable for random orbital sanders: SX E 425, SX E 425 XL, SX E 450 Duo

Order no.

631758000\*

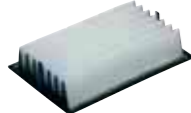
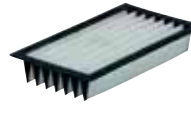
Dust collector cartridges		Order no.
	<b>Dust collection cartridge</b> With pleated filter 631980000, can be cleaned several times Suitable for orbital sanders/multi sanders: SRE 4350 TurboTec, SRE 4351 TurboTec	625598000*
	<b>Dust collection cartridge</b> With pleated filter 631980000, can be cleaned several times Suitable for random orbital sanders: SXE 425 TurboTec, SXE 450 TurboTec	625599000*
	<b>Dust collection cartridge</b> Dust collector cartridge including dust filter 625602000 Suitable for orbital sanders/multi sanders: FMS 200 Intec, FSR 200 Intec Suitable for random orbital sanders: FSX 200 Intec	625601000*
	<b>Dust collection cartridge</b> With pleated filter 631980000, can be cleaned several times Included in scope of delivery for SR 10-23 Intec / SXE 325 Intec Suitable for orbital sanders/multi sanders: SR 10-23, SR 10-23 Intec, SR 20-23, SR 180 suitable for random orbital sander: SXE 325 Intec	631981000



Pleated filters		Order no.
	<b>Pleated filter</b> Pleated filter, polyester, for dust collector cartridge 625601000 Suitable for orbital sanders/multi sanders: FMS 200 Intec, FSR 200 Intec Suitable for random orbital sanders: FSX 200 Intec	625602000*
	<b>Pleated filter</b> Polyester (as spare), for the dust collector cartridges 631981000, 625599000, 625598000 Suitable for orbital sanders/multi sanders: SR 10-23, SR 10-23 Intec, SR 20-23, SRE 4350 TurboTec, SRE 4351 TurboTec, SR 180 Suitable for random orbital sanders: SXE 425 TurboTec, SXE 450 TurboTec	631980000*

Connector		Order no.
	<b>Connector</b> ■ Connector Ø 35 mm for connecting to a normal vacuum cleaner Suitable for orbital sanders/multi sanders: FMS 200 Intec, FSR 200 Intec Suitable for random orbital sanders: FSX 200 Intec	626996000*

### Sanding Belts for Belt Sanders

#### Sanding belts for wood and metal, »professional« series

- High-quality sanding paper with high coarseness and high removal of material
- For veneers, solid wood, polyester, steel and stainless steel sheets, non-ferrous metals, light alloys
- For sanding veneered cabinet fronts and sides, sanding furniture covered with liners with hot-melt type adhesive edges, sanding-based repair work, and deburring cut sheet metal etc.



	Dimensions mm	Grit	Sales unit	Order no.
	<b>Sanding belts 75 x 533 mm</b>			
	75 x 533	P 40	3	631001000*
	75 x 533	P 60	3	631002000*
	75 x 533	P 80	3	631003000*
	75 x 533	P 100	3	631004000*
	75 x 533	P 120	3	631005000*
	75 x 533	P 180	3	631006000*
	75 x 533	P 240	3	631007000*
	75 x 533	P 320	3	631008000*
	75 x 533	P 40	10	625929000*
	75 x 533	P 60	10	625930000*
	75 x 533	P 80	10	625931000*
	75 x 533	P 100	10	625932000*
	75 x 533	P 120	10	625933000*
	<b>Sanding belts 75 x 575 mm</b>			
	75 x 575	P 40	3	625940000*
	75 x 575	P 60	3	625941000*
	75 x 575	P 80	3	625942000*
	75 x 575	P 100	3	625943000*
	75 x 575	P 120	3	625944000*
	<b>Sanding belts 180 x 1550 mm</b>			
	180 x 1,550	P 60	2	631190000
	180 x 1,550	P 80	2	631191000
	180 x 1,550	P 100	2	631192000
	180 x 1,550	P 150	2	631193000
	180 x 1,550	P 80	2	631195000

### Sanding Belt Assortments

#### Assortment of sanding belts for wood and metal, »professional« series

	Order no.
 <b>3 Sanding belts</b> Assortment (each 1 x P60, P80, P100) Dimensions: 75 x 533 mm	625928000*

### Additional Accessories for Belt Sanders

	Order no.
 <b>Bases for Sanding Belts</b> Made from graphite-coated fabric; suitable for Ba E 1075 Sales unit: 2	631034000*
 <b>Bases for Sanding Belts</b> Made from graphite-coated fabric; granular version; Dimensions 84 x 160 mm; suitable for BAE 75 Sales unit: 2	631114000*

# Long-neck sanders: Light, adaptable, practical.

Faster, more adaptable, cleaner: needs voiced by pros when sanding walls and ceilings. Whether sanding close to edges or the need for optimal extraction – our new long-neck sanders fulfil all the desired criteria with distinction so that you can more easily achieve your goal: precise surface finishing! In the system combination with the vacuum cleaners ASR 35 L, M or H ACP and the matching sanding media, optimum work results and maximum productivity are achieved.



**M-Clean-Technology**  
Effective extraction through the machine housing for maximum flexibility of the sanding head

**Optimum balance**  
when working, as the centre of gravity of the machine is not at the sanding head

**Rotating sanding head**  
for working near edges

**Optimum extraction results**  
thanks to the spring-mounted brush rim that adapts to the surface

**Bright LED sidelight**  
to help detect imperfections and serrations and ensure a perfect finish



**T-Handle**  
No kinking of the suction hose and cables when putting the machine down after use

LSV 5-225 Comfort

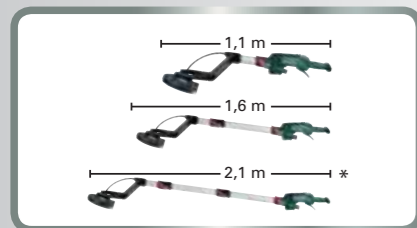

**Variable length adjustment (LSV 5-225 Comfort):**  
can be shortened or extended quickly and easily for narrow rooms or high rooms  
\*extension 626665000 to 2.1 m available as accessory



**The LSV 5-225 is a lightweight at only 3.8 kg.**



**Maximum productivity**  
with the right system:  
in combination with the ASR 35 L ACP or ASR 35 M ACP vacuum cleaner with automatic filter cleaning and grinding media from the extensive range of accessories

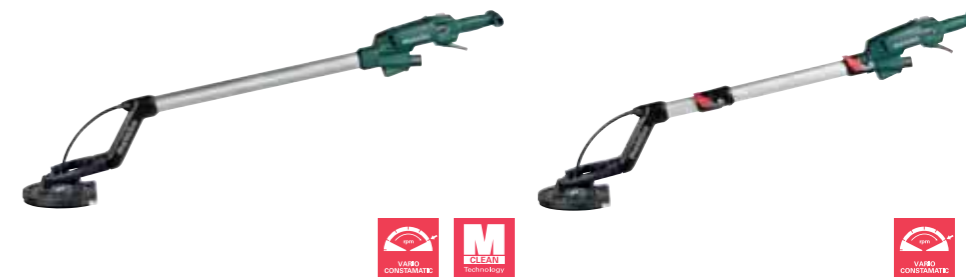

**Technical data**

	Long-neck Sander LSV 5-225	Comfort Long-neck Sander LSV 5-225
Sanding disc diameter	225 mm	225 mm
No-load speed	1,000 - 1,650 /min	1,000 - 1,650 /min
Rated input power	500 W	500 W
Output power	270 W	270 W
Adjustable machine length	1.6 m	1.1 m / 1.6 m / 2.1 m
Weight (without mains cable)	3.8 kg	4.5 kg
Cable length	4 m	4 m

**Scope of delivery**

Order no.	600103	600136
Sanding pad (very soft)	■	■
Hook and loop sanding sheets with multi-perforation (1 each of P80, P100, P120, P150)	■	■
Flexible shaft (as replacement)	■	■
Coupling bush	■	■
Hexagonal wrench	■	■
Tool bag	■	■
Extension		■
Plastic carry case		■

**Product advantages**

- Low weight reduces fatigue when working continuously
- Optional LED side light to help detect imperfections and serrations
- Variable length adjustment: can be shortened or extended without tools for narrow rooms or high ceiling rooms
- Extendable to an overall length of 2.1 m with additional extension (accessory)
- For convenient sanding of primed surfaces on walls or ceilings
- Optimum balance when working, as the centre of gravity of the machine is not at the sanding head
- M-Clean technology: Effective extraction through the machine housing for maximum flexibility of the sanding head
- Sanding near edges, corners and adjoining sections - time-saving and effective
- Ideal adaptation of the flexible sanding head to the surface for good work results
- Optimum extraction results thanks to spring-mounted brush rim that adapts to the surface.
- Vario-Constamatic (VC)-Full wave electronics for working at customised speeds to suit the application materials, and speeds that remain almost constant even under load
- Ergonomically shaped aluminium handle bar and T-handle for comfortable use in different positions
- Simple, quick and tool-free exchangeable shaft can be adjusted directly on site if needed
- Putting the machine down without kinking the hose and cable
- With extensive range of grinding media for every application

**System components**

Accessories → 362

Extraction systems → 453

# Which sanding media for which application?

	Hook and loop sanding sheets, »professional«, multi-perforation	Hook and loop sanding sheets, »professional«, stearate coated	Abrasive Mesh	Hook and loop sanding sheets, »professional«, SiC	Nylon Web	Sanding pad, soft, Ø 225 mm order no. 626662000	Sanding pad, hard, Ø 225 mm order no. 626661000
Area of application							
Sanding of compound seams	■	■	■			■	■
	P40 - P120	P40 - P120	P80 - P120			for soft filler compound	for hard filler compound
Sand full-surface filled areas	■	□	□			■	■
	P80 - P180	P80 - P180	P80 - P120			for soft filler compound	for hard filler compound
Surface fine polish (high-quality reworking)	■	■				■	■
	P180 - P220	P180 - P220					
Removal of wall paper residue	■	■	□			■	■
	P100 - P180	P100 - P180	P100				
Spot sanding / sanding of old paint layers	□	■	■				■
	P40 - P100	P40 - P100	P80 - P120				
Spot sanding of base coat	■	■	■				■
	P80 - P100	P80 - P100	P80				
Spot sanding of insulation boards (e.g. Styrofoam)/joints				■			■
				P16			
Spot sanding of surfaces with wall-paper (woodchip)				■			■
				P16			
Spot sanding of old paint layers prior to applying a new layer					■	■	■
					A100 - A180		

□ Well suited ■ Highly suitable

## Sanding Sheets for Long-neck Sanders

### Hook and loop sanding sheets, »professional« series



- High-quality silicone carbide sanding paper for spot sanding and roughing of surfaces such as styrofoam boards for thermal insulation, as well as for woodchip for faster absorption of liquids when removing wallpaper.

Diameter mm	Grit	Sales unit	Order no.
225	P 16	10	626640000*

### Hook and loop sanding sheets for filler, paints and lacquers, »professional« series

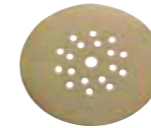

- High-quality sanding paper with very open coarseness and high removal of material. From grit 150 stearate-coated
- Especially for processing fillings in drywall construction, and for paint, varnish.

Diameter mm	Grit	Sales unit	Order no.
225	P 40	25	626641000*
225	P 60	25	626642000*
225	P 80	25	626643000*
225	P 100	25	626644000*
225	P 120	25	626645000*
225	P 150	25	626646000*
225	P 180	25	626647000*
225	P 220	25	626648000*

### Hook and loop sanding sheets with multi-perforation for filler, paints and lacquers, »professional« series



- High-quality sanding paper, full-surface perforated, with high removal of material
- Particularly effective extraction thanks to the full-surface perforation and special hook and loop layer for low-dust working
- Minimized clogging of the grinding media, providing greater material removal and longer tool life.
- Especially for processing fillings in drywall construction, and for paint, varnish.

Diameter mm	Grit	Sales unit	Order no.
225	P 40	25	626649000
225	P 60	25	626650000
225	P 80	25	626651000
225	P 100	25	626652000
225	P 120	25	626653000
225	P 150	25	626654000
225	P 180	25	626655000
225	P 220	25	626656000

## Nylon Webs for Long-neck Sanders



- Suitable for spot-grinding, roughening, degreasing and matting of surfaces
- Particularly suited for spot sanding of glazed wooden surfaces e.g. glazed slot and spring board connections.

Diameter mm	Grit	Sales unit	Order no.
225	A 100	10	626659000
225	A 280	10	626660000





Abrasive Mesh for Long-neck Sanders



- Especially for processing fillings in drywall construction
- Suitable for pliable areas that are not yet completely set.

Diameter mm	Grit	Sales unit	Order no.
225	P 80	25	626657000*
225	P 100	25	626658000*
225	P 120	25	626666000*

Further Accessories for Long-neck Sanders

	Order no.
 <p><b>Sanding pad hard</b></p> <ul style="list-style-type: none"> <li>■ Particularly suited for high material removal.</li> </ul> <p>Diameter: 225 mm Hardness: hard Version: perforated (18 holes)</p>	626661000*
 <p><b>Sanding pad</b></p> <ul style="list-style-type: none"> <li>■ Very soft, flexible sanding pad, particularly suited for curved, uneven surfaces</li> <li>■ Standard version of the long-neck grinder</li> </ul> <p>Diameter: 225 mm Hardness: very soft Version: perforated (18 holes)</p>	626662000*
 <p><b>Replacement brush rim</b></p> <ul style="list-style-type: none"> <li>■ Replacement brush rim long-neck sander</li> </ul>	626663000*
 <p><b>Flexible shaft</b></p> <ul style="list-style-type: none"> <li>■ Replacement shaft as contained in the scope of delivery</li> <li>■ Simple, quick and tool-free exchangeable shaft easily changed on site if needed</li> </ul>	626664000*
 <p><b>Extension</b></p> <ul style="list-style-type: none"> <li>■ Provides a machine length of 2.1 m</li> <li>■ Installation without tools</li> <li>■ Easy and safe storage in the machine case</li> <li>■ Length: 550 mm</li> </ul>	626665000*



Technical data	Router and grinder motor FME 737
No-load speed	13,000 - 34,000 /min
Rated input power	710 W
Output power	430 W
Revolutions at rated load	24,000 /min
Collet chuck bore	8 mm
Weight (without mains cable)	1.4 kg
Cable length	4 m

Scope of delivery	
Order no.	600737
2 open-jawed spanners	■

Product advantages

- Hardened and ground interchangeable collet chuck for precise concentricity of tools
- Metabo Marathon-motor with patented dust protection for long service life
- Vario-Constamatic (VC)-Full wave electronics for working at customised speeds to suit the application materials, and speeds that remain almost constant even under load
- Thumbwheel for speed preselection
- Electronic overload protection for long service life
- Restart protection: prevents unintentional start-up after power supply interruption
- Electronic safety shutdown of the motor for safe working in case the tool stops unexpectedly
- Auto-stop carbon brushes to protect the motor
- Motor can be upgraded to a router using the moulding/routing attachment (accessory)
- Suitable for actuating flexible shafts



Technical data	Router OFE 738
Maximum stroke height	50 mm
No-load speed	13,000 - 34,000 /min
Rated input power	710 W
Output power	430 W
Revolutions at rated load	24,000 /min
Collet chuck bore	8 mm
Weight (without mains cable)	3 kg
Cable length	4 m

Scope of delivery	
Order no.	600738
Parallel guide / Rip fence	■
Extraction connector	■
Open-jawed spanner	■

Product advantages

- Robust and torsion-resistant 2-column guide for highest precision
- Hardened and ground interchangeable collet chuck for precise concentricity of tools
- Spindle lock for easy router bit change
- Metabo Marathon-motor with patented dust protection for long service life
- Vario-Constamatic (VC)-Full wave electronics for working at customised speeds to suit the application materials, and speeds that remain almost constant even under load
- Thumbwheel for speed preselection
- Restart protection: prevents unintentional start-up after power supply interruption
- Electronic safety shutdown of the motor for safe working in case the tool stops unexpectedly
- Aluminium die cast base plate with coating for easy sliding
- Auto-stop carbon brushes to protect the motor
- Can also be used on the guide rail using an intermediate plate (accessory)
- Bayonet fitting of the motor in moulding/routing attachment; suitable for use with flexible shafts
- Extraction possibility by means of connecting an all-purpose vacuum cleaner

System components

Accessories → 367

Extraction systems → 453

\*Self-service packaging

01  
02  
03  
04  
05  
06  
07  
08  
09  
10  
11  
12  
13  
14  
15





### Technical data

#### Router Of E 1229 Signal

Maximum stroke height	50 mm
No-load speed	5,000 - 25,500 /min
Rated input power	1,200 W
Output power	780 W
Revolutions at rated load	25,500 /min
Collet chuck bore	8 mm
Weight (without mains cable)	3.5 kg
Cable length	4 m

### Scope of delivery

Order no.	601229
Fine adjustment parallel guide/rip fence	■
Dial gauge for fine adjustment	■
Extraction connector	■
Open-jawed spanner	■

### Product advantages

- Dial gauge for fine tuning the cutting depth in 0.1. mm increments
- Three-level stop to preselect up to 3 different cutting depths
- Robust and torsion-resistant 2-column guide for highest precision
- Hardened and ground interchangeable collet chuck for precise concentricity of tools
- Spindle lock for easy router bit change
- Vario-Tacho-Constamatic (VTC)-Full Wave Electronics for work with materials requiring customised speeds, which remain constant under load
- Thumbwheel for speed preselection
- Overload protection: protects the motor from overheating
- Aluminium die cast base plate with coating for easy sliding
- Auto-stop carbon brushes to protect the motor
- Precise parallel guide/rip fence guided in prisms with fine adjustment for precise milling
- Can also be used on the guide rail using an intermediate plate (accessory)
- Extraction possibility by means of connecting an all-purpose vacuum cleaner

### System components

Accessories → 367

Extraction systems → 453

## Collets

for OFE 738, Of E 1229 Signal, FME 737







Collet bore	Version	Order no.
3 mm	hexagon	631947000*
1/8" (3.18 mm)	hexagon	631948000*
6 mm	hexagon	631945000*
6 mm	double flat	630820000
8 mm	hexagon	631946000*
1/4" (6.35 mm)	double flat	631949000

For Of E 1812



Collet bore	Version	Order no.
8 mm	hexagon	631567000

## Accessories for Routers OFE 738 and Of E 1229 Signal

	Order no.
 <p><b>Parallel guide</b></p> <ul style="list-style-type: none"> <li>■ Parallel guide/rip fence with fine adjustment for routers OFE 738 and Of E 1229 Signal (supplied as standard)</li> </ul>	631507000
 <p><b>Guide with guide roller</b></p> <ul style="list-style-type: none"> <li>■ For fitting on the parallel guide/rip fence of routers OFE 738 and Of E 1229 Signal, for moulding/routing curved edges</li> </ul>	630360000
 <p><b>Circle-cutting centering pin</b></p> <ul style="list-style-type: none"> <li>■ For using in the parallel guide/rip fence of routers OFE 738 and Of E 1229 Signal, for milling circular grooves and similar work</li> </ul>	631504000
 <p><b>Intermediate plate</b></p> <ul style="list-style-type: none"> <li>■ For fixing on the base plate of routers OFE 738 and Of E 1229 Signal, especially suited for trimming edging strips flush with edges</li> </ul>	631503000
 <p><b>Circle-cutting guide</b></p> <ul style="list-style-type: none"> <li>■ For cutting out round openings, moulding/routing circular grooves, rounding off corners, etc., maximum circle diameter 350 mm</li> </ul>	631505000

### Template followers



- For engraving text etc. using a template clamped on to the workpiece

Diameter mm	Order no.
9	630105000
11	630106000
17	630118000
24	630119000
27	630120000
30	630121000

\*Self-service packaging

Guide rail		Order no.
	<p><b>Guide rail</b></p> <ul style="list-style-type: none"> <li>■ Guide rail made of sturdy, anodised aluminium extrusion</li> <li>■ Anti-slip backing provides safe and reliable support and protects the work piece surface against scratches</li> <li>■ Guide rule, adjustable to eliminate play</li> </ul> <p>suitable for: Metabo jigsaws, circular saws and router models OFE 738 and Of E 1229 Signal (when using the appropriate accessories; KS 55 FS, KSE 55 Vario Plus, KS 66 Plus, KSE 68 Plus can be used directly); also suitable for the CED 125 Plus dust extraction shroud in connection with an angle grinder Overall length: 1,500 mm</p>	631213000

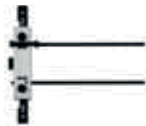
Router guide		Order no.
	<p><b>Router guide</b></p> <ul style="list-style-type: none"> <li>■ Enables moulding/routing with routers OFE 738 and Of E 1229 Signal along the precision guide rails</li> </ul> <p>For these tasks the 631503000 intermediate plate must be fitted to the router's base plate</p>	631248000

Other Accessories for the Router and Grinder Motor

Moulding/routing attachment		Order no.
	<p><b>Moulding/routing attachment</b></p> <ul style="list-style-type: none"> <li>■ With this moulding/routing attachment, router and grinder motor FME 737 can be converted into a router</li> </ul>	631501000

Flexible shafts		Order no.
	<p><b>Flexible shaft 27609</b></p> <ul style="list-style-type: none"> <li>■ Suitable for speeds of 20,000 to 30,000 rpm</li> <li>■ Bearing-mounted at both ends</li> <li>■ For router bits, mounted points, flap wheels etc. with 6 mm shaft diameter. Interchangeable collet for accessories with 3 mm shaft diameter available as accessory (630715000)</li> <li>■ 6 mm driving shaft for fixing the flexible shaft in the collet bore of the drive machine. If the collet bore of the drive machine has a different dimension than 6 mm, the collet of the drive machine must be changed. 6 mm collet available as accessory (631945000)</li> </ul> <p>suitable for routers: FME 737 suitable for die grinders: G 500, GE 700, GE 710 Compact, GE 710 Plus Length: 1.3 m Driving shaft: 6 mm Collet bore: 6 mm Weight: 0.8 kg</p>	627609000*

		Order no.
	<p><b>Flexible shaft 30980</b></p> <ul style="list-style-type: none"> <li>■ Suitable for speeds of 7,500 to 30,000 rpm</li> <li>■ Bearing-mounted at both ends</li> <li>■ For router bits, mounted points, flap wheels etc. with 8 mm shaft diameter. Interchangeable collet for accessories with 6 mm shaft diameter (630977000) and 3 mm shaft diameter (630976000) available as accessory</li> <li>■ 8 mm driving shaft for fixing the flexible shaft in the collet bore of the drive machine. If the collet bore of the drive machine has a different dimension than 8 mm, the collet of the drive machine must be changed. 6 mm collet available as accessory (631945000)</li> </ul> <p>suitable for routers: FME 737 suitable for die grinders: G 500, GE 700, GE 900 Plus, GE 710 Compact, GE 710 Plus, GE 950 G Plus Length: 1.3 m Driving shaft: 8 mm Collet bore: 8 mm Weight: 0.8 kg</p>	630980000*

Collets for flexible shafts		
Collet bore		Order no.
<b>Collets for flexible shaft 630980000</b>		
■ To attach the carbide router bits, mounted points etc. to the flexible shaft		
3 mm		630976000
6 mm		630977000
8 mm		630979000
<b>Collets for flexible shaft 627609000</b>		
■ For fixing the carbide router bits, mounted points, etc. on the flexible shaft		
6 mm		630714000
3 mm		630715000

Clamping stand		Order no.
	<p><b>Clamping stand</b></p> <ul style="list-style-type: none"> <li>■ For safe clamping of drills and impact drills as well as die grinders and the motor of the router when working with flexible shafts. Aperture Ø 43 mm. The clamp (627107000) serves for the secure fixing</li> </ul>	627354000*

Clamp		Order no.
	<p><b>Clamp</b></p> <ul style="list-style-type: none"> <li>■ For the secure fixing on a work table</li> </ul>	627107000*

\*Self-service packaging

01  
02  
03  
04  
05  
06  
07  
08  
09  
10  
11  
12  
13  
14  
15



Technical data	Paint Remover LF 724 S
Torque	2 Nm
Cutting edge cycle	80 mm
Maximum notch depth	unlimited
Lateral cutting height	28 mm
Axial cutting depth	0 - 0.3 mm
Radial cutting depth	0.15 mm
Rated input power	710 W
Output power	430 W
No-load speed	10,000 /min
Revolutions at rated load	6,700 /min
Weight (without mains cable)	2.4 kg
Cable length	4 m

#### Scope of delivery

Order no.	600724 <sup>1)</sup>
4 Carbide reversible blades	■
Extraction connector	■
Adjusting wrench with handle	■
Combo-spanner	■
Plastic carry case	■

<sup>1)</sup> also available in 120 V (North/Latin America)

#### Product advantages

- Only from Metabo: the problem solver for renovation work. Saves up to 70% of time when compared to conventional working methods
- For the environmentally-friendly removal of paint and varnish from even wooden surfaces, such as stairs, doors and windows
- Suitable for processing untreated wood
- Suitable for processing notches by virtue of lateral blades
- Variably adjustable cutting depth
- Die cast aluminium gear housing for optimum heat dissipation and long service life
- Carbide reversible blade, can be used on four sides for a long service life
- Extraction possibility by means of connecting an all-purpose vacuum cleaner

#### System components

Accessories → 372

Extraction systems → 453

# 18 V



Technical data	Cordless Planer HO 18 LTX 20-82
Type of battery pack	Li-Ion / LiHD
Battery pack voltage	18 V
Planing width	82 mm
Adjustable planing depth	0 - 2.0 mm
Maximum notch depth	9 mm
No-load speed	16,000 /min
Length of planer base	295 mm
Weight (including battery pack)	3.5 kg

#### Scope of delivery

Order no.	602082
1 Set of disposable planer blades	■
Parallel guide / Rip fence	■
Depth gauge	■
Chip ejection adapter	■
Textile dust bags	■
2 Li-Power battery packs (18 V/4.0 Ah)	■
Charger ASC 30-36 V »AIR COOLED«	■

#### Product advantages

- Light, compact cordless planer for planing, rebating and chamfering
- Adjustable planing depth and notch depth
- Aluminium die cast and milled cut planer base with V-groove for easy chamfering
- Parallel guide / rip fence for precise guiding of the planer
- Grip area with non-slip soft-grip surface
- Extraction possibility by means of connecting an all-purpose vacuum cleaner
- Angled chip ejection adapter for controlled ejection of the wood shavings
- Easy to empty textile dust bag for working without extraction facilities
- Strap on the planer base for stopping the machine and to protect the work piece
- Easy blade change of the robust reversible carbide planer blades
- Soft start and overload protection for long service life of motor and drive

#### System components

Accessories → 372

Battery packs → 72

Technical data	Planer HO 26-82
Planing width	82 mm
Adjustable planing depth	0 - 2.6 mm
Maximum notch depth	9 mm
No-load speed	17,000 /min
Rated input power	620 W
Output power	360 W
Revolutions at rated load	11,200 /min
Length of planer base	295 mm
Weight (without mains cable)	2.7 kg
Cable length	4 m

#### Scope of delivery

Order no.	602682 <sup>1) 2)</sup>
1 Set of disposable planer blades	■
Parallel guide / Rip fence	■
Depth gauge	■
Extraction connector	■
Chip ejection adapter	■
Textile dust bags	■
Hexagonal wrench	■

<sup>1)</sup> also available in 120 V (North/Latin America)

<sup>2)</sup> also available in 110 V (UK)

#### Product advantages

- Light, compact universal planer for planing, rebating and chamfering
- Adjustable planing depth and notch depth
- Aluminium die cast and milled cut planer base with V-groove for easy chamfering
- Parallel guide / rip fence for precise guiding of the planer
- Grip area with non-slip soft-grip surface
- Extraction possibility by means of connecting an all-purpose vacuum cleaner
- Angled chip ejection adapter for controlled ejection of the wood shavings
- Easy to empty textile dust bag for working without extraction facilities
- Strap on the planer base for stopping the machine and to protect the work piece
- Easy blade change of the robust reversible carbide planer blades

Extraction systems → 453

Accessories for Paint Remover

Reversible carbide blades



- High-quality carbide for long tool life and uniform grinding result

Sales unit	Order no.
4	631720000*
10	631660000*

Suction hose



Suction hose

- With bayonet fitting and rubber connector (internal Ø 30 mm, outside Ø 35 mm)
- Connector Ø: 58/58 mm
- Hose length: 3.5 m
- Suction hose Ø: 27 mm

Order no.  
631938000

Planer Accessory

Reversible carbide planer blades



Reversible carbide planer blade

- Consisting of 2 reversible carbide planer blades suitable for: HO 18 LTX 20-82, HO 26-82, HO 0882

Order no.  
630282000\*



Reversible carbide planer blade

- Consisting of 10 reversible carbide planer blades suitable for: HO 18 LTX 20-82, HO 26-82, HO 0882

Order no.  
630272000

Additional accessories for planers



Stand for planer

- For stationary use of the planer (as surface planer)
- Clamp 627107000 for fastening the stand securely on a workbench suitable for: HO 0882

Order no.  
631599000\*



Clamp

- For the secure fixing on a work table

Order no.  
627107000\*



Sawing

\*Self-service packaging

18 V



Technical data	Cordless Circular Saw KS 18 LTX 57
Type of battery pack	Li-Ion / LiHD
Battery pack voltage	18 V
Swivel range from / to:	0 °/+ 50 °
Adjustable cutting depth	0 - 57 mm
Maximum cutting depth at 90°	57 mm
Maximum cutting depth at 45°	43 mm
Saw blade Ø x bore	Ø 165 x 20 mm
No-load speed	4,600 /min
Max. cutting speed	40 m/s
Weight (including battery pack)	3.7 kg

**Scope of delivery**

Order no.	601857
Carbide circular saw blade (18 teeth)	■
Parallel guide / Rip fence	■
Hexagonal wrench	■
2 LiHD battery packs (18 V/8.0 Ah)	■
Charger ASC 30-36 V »AIR COOLED«	■
MetaLoc case	■
MetaLoc case insert	■

Equipment variants can be found in the Metabo price list and on the internet

**Product advantages**

- Powerful, light, cordless circular saw for universal use on construction sites
- Aluminium base plate can be directly used on guide rails from Metabo and other manufacturers
- Fast brake stops the saw blade quickly and improves safety
- Accurately angled bevel cuts down to 50°, with handy snap-in point at 45°
- 0° position re-adjustable for highest cutting precision
- Clearly visible cutting indicator for precise sawing after initial cut
- Handle with non-slip soft-grip surface for safe guidance
- Extraction possibility by means of connecting an all-purpose vacuum cleaner
- Battery packs with capacity display for checking the charge status

**System components**

Accessories → 378

Battery packs → 72

Extraction systems → 453



Technical data	Circular Saw KS 55	Circular Saw KS 55 FS
Rated input power	1,200 W	1,200 W
Output power	670 W	670 W
Maximum cutting depth at 90°	55 mm	55 mm
Maximum cutting depth at 45°	39 mm	39 mm
Saw blade Ø x bore	Ø 160 x 20 mm	Ø 160 x 20 mm
Swivel range from / to:	0 °/+ 47 °	0 °/+ 47 °
No-load speed	5,600 /min	5,600 /min
Revolutions at rated load	4,400 /min	4,400 /min
Max. cutting speed	47 m/s	47 m/s
Torque	5 Nm	5 Nm
Weight (without mains cable)	4 kg	4 kg
Cable length	4 m	4 m

**Scope of delivery**

Order no.	600855	600955
Carbide circular saw blade (18 teeth)	■	■
Parallel guide / Rip fence	■	■
Extraction connector	■	■
Hexagonal wrench	■	■

Equipment variants can be found in the Metabo price list and on the internet

**Product advantages**

- Light, compact circular saw for universal construction site use
- Robust circular saw, can be used directly on Metabo guide rails and rails of other manufacturers
- Light guide plate made from die cast aluminium
- Adjustment of machine without tools for using with the precision guide rail
- Grip area with non-slip soft-grip surface
- Clearly visible cutting indicator for precise sawing after initial cut
- 0° position re-adjustable for highest cutting precision
- Extraction possibility by means of connecting an all-purpose vacuum cleaner

**System components**

Accessories → 378

Extraction systems → 453



Technical data	Plunge Cut Circular Saw KSE 55 Vario Plus
Rated input power	1,200 W
Output power	700 W
Maximum cutting depth at 90°	55 mm
Maximum cutting depth at 45°	40 mm
Saw blade Ø x bore	Ø 160 x 20 mm
Swivel range from / to:	0 °/+ 45 °
No-load speed	2,000 - 5,200 /min
Revolutions at rated load	5,200 /min
Max. cutting speed	44 m/s
Torque	5 Nm
Weight (without mains cable)	3.7 kg
Cable length	4 m

Scope of delivery

Order no.	601204
Carbide circular saw blade (42 teeth)	■
Parallel guide / Rip fence	■
Extraction connector	■
Hexagonal wrench	■

Equipment variants can be found in the Metabo price list and on the internet

Product advantages

- Combined plunge cut circular saw – two high-quality functions in one machine
- Metabo S-automatic safety clutch: mechanical decoupling of the drive for safe working should the saw blade stop unexpectedly.
- Convenient saw blade change due to simultaneous pendulum saw guard and saw blade stop
- Particularly light due to magnesium die-cast saw housing and guide plate
- Grip area with non-slip soft-grip surface
- Sawing close to wall possible
- Precise, double-track aluminium parallel guide/rip fence makes cutting to size easier
- Clearly visible cutting indicator for precise sawing after initial cut
- 0° position re-adjustable for highest cutting precision
- Vario Tacho Constamatic (VTC) Full-wave Electronics for work with materials requiring customised speeds, which remain constant under load
- Overload protection: protects the motor from overheating
- Extraction possibility by means of connecting an all-purpose vacuum cleaner
- Controllable chip ejection by means of rotating extraction nozzle
- Auto-stop carbon brushes to protect the motor
- Adjustment of machine without tools for using with the precision guide rail

System components

Accessories → 378 | Extraction systems → 453



Technical data	Circular Saw KS 66	Circular Saw KS 66 Plus	Circular Saw KSE 68 Plus
Rated input power	1,400 W	1,400 W	1,600 W
Output power	800 W	800 W	850 W
Maximum cutting depth at 90°	66 mm	66 mm	68 mm
Maximum cutting depth at 45°	47 mm	47 mm	48 mm
Saw blade Ø x bore	Ø 190 x 30 mm	Ø 190 x 30 mm	Ø 190 x 30 mm
Swivel range from / to:	0 °/+ 45 °	0 °/+ 45 °	0 °/+ 45 °
No-load speed	4,200 /min	4,200 /min	2,000 - 4,200 /min
Revolutions at rated load	3,200 /min	3,200 /min	4,200 /min
Max. cutting speed	42 m/s	42 m/s	42 m/s
Torque	9 Nm	9 Nm	11 Nm
Weight (without mains cable)	5.5 kg	5.5 kg	5.6 kg
Cable length	4 m	4 m	4 m

Scope of delivery

Order no.	600542 <sup>1)</sup>	600544	600545
Carbide circular saw blade (14 teeth)	■	■	■
Parallel guide / Rip fence	■		
Aluminium parallel guide/rip fence		■	■
Hexagonal wrench	■	■	■

Equipment variants can be found in the Metabo price list and on the internet  
<sup>1)</sup> also available in 120 V (North/Latin America)

Product advantages

- Precise cuts with guide rail and matching adapter (accessory)
- Fast brake for increased safety with quick saw blade stop
- Vario Tacho Constamatic (VTC) Full-wave Electronics for work with materials requiring customised speeds, which remain constant under load
- Overload protection: protects the motor from overheating
- Sturdy guide plate made from die cast magnesium
- Grip area with non-slip soft-grip surface
- Adjustment of machine without tools for using with the precision guide rail
- Metabo S-automatic safety clutch: mechanical decoupling of the drive for safe working should the saw blade stop unexpectedly.
- Clearly visible cutting indicator for precise sawing after initial cut
- 0° position re-adjustable for highest cutting precision
- Lubrication system for long service life of the gear
- Extraction possibility by means of connecting an all-purpose vacuum cleaner
- Controllable chip ejection by means of rotating extraction nozzle
- Auto-stop carbon brushes to protect the motor

System components

Accessories → 378 | Extraction systems → 453

# Circular saw blades: Long service life and precise, clean cuts.

The best cuts can be achieved with a harmonised system using quality circular saw blades. Metabo carbide circular saw blades offer precise and clean cuts thanks to laser cut expansion slots and ground carbide teeth. They are manufactured in accordance with Metabo quality specifications so that they achieve best work results in combination with our machines. The quality products offer a long service life and save you money.



## Application profiles of the Metabo circular saw blades

- Precision laser saw blades** have a higher bonding strength than stamp-cut saw blades thanks to the due to their high face and rotation accuracy for precise cuts
- Lasered expansion slots** ensure low-noise and low-vibration operation.
- Very high service life** is achieved by the use of pure-grade carbides.
- Extremely long-lasting** due to a tenfold plus re-sharpening potential.
- Our full range is clearly structured.** We differentiate between Power cut, Precision cut and Multi-cut. This helps you to find the ideal saw blade.

### power cut



- For fast coarse and semi-fine cuts with continuous feed for low performance requirements
- Good cutting results for straight cuts in solid wood
- Partially suitable for construction wood with nails and concrete residue
- On coated wood or other composites, only coarse cut quality is possible

### precision cut



- Very wide range of uses in woodworking
- For very good, clean cut results for longitudinal or cross-cuts in softwood and hardwood
- Well suited for hard wood and plywood, untreated chipboards, coated or veneered, MDF, composite materials
- High power consumption so the saw must have a high performance motor

### multi cut

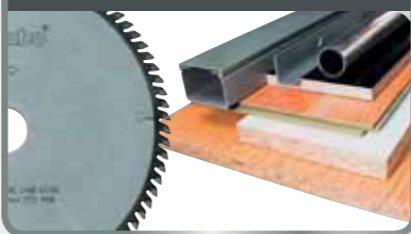

- Universal use for demanding materials
- For the highest standards in cutting quality, e.g. for laminate, plastic, aluminium, copper and bronze materials
- Ideally suited for many interior development applications
- Perfect cutting results, also for cross-cuts in solid wood, coarse, coated or veneered chipboards, MDF
- The circular saw must have a very high performance power
- Relatively slow saw advance

## Technical characteristics of the circular saw blades

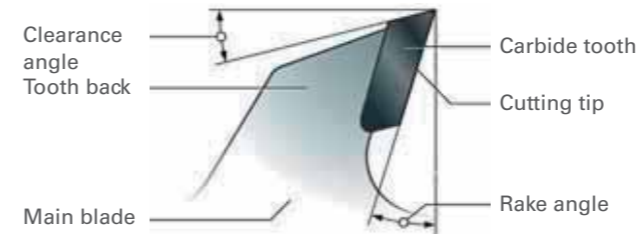

**The rake angle**  
The rake angle influences the cut quality, feed and cutting forces. It always correlates to the desired entry and exit angles to the workpiece.

- The size of the front rake angle depends on:
- The material to be processed (front rake angle decreasing: soft wood - hard wood - chip materials - non-ferrous metals)
  - The respective cutting quality required on one or both edges



**Positive and negative rake angle**  
Positive rake angle:

- Easy cutting action - fast cutting
- Cutting power in the direction of the workbench (hand-held circular saw)
- Workpiece edge: clean on the underside, without splinter guard poor on the upside

- Negative rake angle:
- More difficult cutting process - higher cutting power required from machine
  - Cutting force in the direction of the workpiece support (mitre saws)
  - Workpiece edge on the upper side better than on the underside



**The clearance angle**  
If the clearance angle is too low, chip removal by the next tooth is not possible. A large clearance angle facilitates large chip removal. This is necessary for greater feeds.



**Entry and exit angles on the workpiece**  
In most cases, the exit angle is unfavourable as opposed to the entry angle. For this reason the "good side" should be positioned upside down.

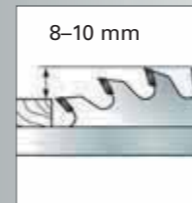

**Saw blade projection**  
With increasing saw blade projection, the quality on the exit side decreases. It does not however improve on the entry side due to the lack of guidance effect. The ideal saw blade projection is between 8 and 10 mm.

### Steel blade thickness

- Thinner blades are suited for thinner materials and require less power. Ideal for cordless applications.
- Thicker blades are particularly stable and are therefore suited for precise cuts in thicker materials on powerful saws.

## Tooth shapes on the circular saw blades



- WZ alternately bevel-ground tooth**
- Exceptionally clean cuts in all softwoods and hardwoods, wood-fibre, laminate and plastic materials
  - Easy to sharpen.
  - With negative rake angle: Use on mitre saws



- FZ flat tooth**
- Ideal for fast and coarse lengthwise cuts in solid wood
  - Simple to maintain



- FZ/TZ flat/trapezoid tooth**
- Ideal for aluminium, copper and brass facing, plastic, coated chipboard and MDF boards and other wooden materials
  - Very clean cuts
  - With negative rake angle: Use on mitre saws



- FZ/FA flat tooth/chamfered flat tooth**
- Used primarily for construction site and table saws, but also for high-output hand-held circular saws
  - Perfectly suited for construction wood, plywood boards (also with nails and concrete residue), chipboards
  - Extremely robust teeth



- DZ/HZ roof/hollow tooth**
- Ideal for boards coated on both sides
  - Very precise and splinter-free cuts



- SP/NV pointed tooth, KV wolf tooth**
- Used for construction site saws and log cutting saws or high-performance table saws
  - Tooth shape only with circular saw blades made from chrome-vanadium steel

## Designation of the circular saw blades

Example:

HW/CT 250 x 2.8/2.0 x 30; Z-80 FZ/TZ 5° neg; 2 NL

HW/CT = wolfram/carbide tipped

Other material descriptions:  
CV = chrome vanadium steel

- 250 = diameter mm
- 2.8 = cutting width mm
- 2.0 = thickness of base body in mm
- 30 = diameter of the bore
- Z=80 = number of teeth
- FZ/TZ = flat trapezoid tooth shape
- 5° neg. = negative rake angle
- 2 NL = secondary hole holder

Which circular saw blade is suited to which machine?

Ø	Ø Bo	Ø	Ø Bo	Ø	Ø Bo	Ø	Ø Bo
<b>AEG</b>							
KS 55-2	165 20	<b>DeWalt</b>		FC7SA, PSM-7, PSU-7	190 30	5703 R	190 30
KS 66-2	190 30	DW 351	152 20	C 7BU2/7U2/7MFA	190 30	2705 R	190 30
PS 216 L	216 30	DCS930KA/KB	165 20	C7 BU3/BUM/U3	190 30	HS7101J1, DHS710ZJ	190 30
TS 250 K; PS 254 L	254 30	DWS 520 K/ KR,	165 20	C7U2, C7BU2	190 30	DHS 710 ZJ, HS 7601 J	190 30
PS 305 DG	305 30	DCS 931N/NT, DWE 550,		C8U/FA, PSM-8, PSU-8	210 30	LS 0810	210 30
		DCS 520NT/T2		C8FC, CSU, CU8	210 30	LS0815FL	216 30
		D23650, DW 365/65/2365K,	190 30	C8FAFC/FS, C 8FSHE	216 30	LS 0815 FL	216 30
		DWE575K, DWE576K		C 12 LCH, C 12 YA/YB,	305 30	5903 R	235 30
		DCS 575 T2/NT,	190 30	C 12 LSH		5900/BR, SR 2300	235 30
		DCS 576 T2/NT		C12 RSH2	305 30	5143 R	250 30
		DCS 7485	210 30	PSU13	315 30	LH1200FL, LS1216LB	305 30
		DW 700/701/707/712/770/	216 30	<b>Holz-Her</b>			
		771/777		1420, 2107, 2108,	160 20	LH 1201 FL	305 30
		DCS 777 T2/N,	216 30	HKU264/50/550		5100 BR, 2712	315 30
		DWS 773/774/777		2103, 2104, 2105, 2106,	160 20	MS 1400	350 30
		DW 383, D 23700	235 30	AP 55 EB, ATF 55 EB		<b>Milwaukee</b>	
		DW125/1251/150/1501/1503/	250 30	2114, 2116, 2117, 2118, 2119,	190 30	M18 FMCS;	150 20
		250/252/320/702/703/710/		2126, 2127, 2269, 282, 2214,		CS 55	160 20
		717/717XPS/720/742/743/		DERBY, T65E		SCS 65 Q	190 30
		743N/744/745/746/S778/		2117, 2119, AP 65 EB,	190 30	M18 CCS66	190 30
		744XP/745,DWS778		AT 65 EB		CS 75	210 30
		DCS 778 T2/N	250 30	2264, 2267, 2279, 2284,	210 30	MS 216 SB	216 30
		1875, 2151, 2154, 2155,	300 30	PKS267/284		M18 SMS216	216 30
		1635-3L/4L, 21553 3L,		2120	230 30	MS 3 C, MS 305 DB	250 20
		DW1370/160DS/305/		2294	230 30	F18 FMS 254	254 30
		8001/8002/8003		HKD85/275, PKS1210/	300 30	MS 305 DB	305 30
		142 DS, 160 DS, 1635,	300 30	1211/1212/1213/1214/		<b>Scheppach</b>	
		DW 810		1215/1220/5275/275		HM 80L/LXU, HS 80	210 30
		DW 721/721KN/722/725/	300 30	HKS130/150/176/276	350 30	HM 80MP	216 30
		726/8101/8012/8103		HKS277/2137	400 30	HS100	250 30
		DW704/705/706/708/716/	305 30	<b>Mafell</b>			
		716 E/718, D27105/27107/		A 55, B 55, FU 55, KSS 400,	160 20	HM 100 LU, LXU, T	254 30
		27107XPS/27111/27112/		KSS 330, MKS 55, MS 55,		TK 1685 Magnum,	300 30
		27113, DWS780		MT 55, PS 52/5 S, X 55,		TS 4000, Duo 7.0,	
		DHS 780 T2A	305 30	XE 55, KST 55, KSS 400/		Bestcombi 7.0	
		D27400	315 30	400 36V, PS 3100 SE		Capas 3, Capas 7.0	305 30
		DW1420S/1600S/729KN	350 30	KSP 55/55 F, KST 55	160 20	HM 120L	305 30
		C14,1635, 6L, 2155, 6	400 30	KS 320, PSS 3100	160 20	Forsato XL/XXL, TS 315, TK,	315 30
		163546+62, 2155-4+6, C	400 30	KSS 50/K55	168 20	TKH, TKU, TS 4010, Tisa 5.0	
		6K/L, BK, DA 1635	500 30	KSP 65 F, MKS 65	190 30	TS 310, HS 120	315 30
		<b>Festool</b>		ERIKA 60, KS 65, MS 65	190 30	BSH 500/400	400 30
		AP 553, ATF 55 FS,	160 20	MKS 75/85 S, MS 75	210 30	BS 500, BSH 500, WS 500	500 30
		AT 55 EFS/55 EB		KSP 85/85 F	230 30	KE 6/60/6011, KH 6/60,	600 30
		AP 55/55 E/55 EB	160 20	ERIKA 85 L, MKS 85 S,	250 30	KW 60/6011/611	
		ATF 55/55 E/55 EB, TS 55/	160 20	MS 85, ERIKA 85 Ec		KD 2700, KE 70/70 M,	700 30
		55 RQ-Plus, TSC 55 Li REB-		BIBER, BIBEREX, FS 85,	315 30	KEZ 700, KH 70,	
		Basic		MKS 105/105 E, MONIKA,		KW 2700/70/70 M,	
		HK 55 EBO-Plus, HKC 55 EB	160 20	TFK 85/8		KWZ 7/700	
		Li-Basic		BSK 4/5/6, MKS 125, SF 32	350 30	Wox d700s	700 30
		AT 65/65 E	190 30	AZB, BK 3, FKB 150,	400 30	Precisa 6.0	315 30
		AT 65 FS, ATF 65 B/65 E,	190 30	FS 130 K/130 S, TD 3,		Forsa 4.0/6.0, 8.0/9.0	315 30
		AT 66		TDH 4, TK 150, VKS 130/	160, BSK 4	Structo 5.0/7.0	500 30
		AP 65/65 E/65 EB	190 30	160, BSK 4		Capas 5.0	254 30
		TS 75/75 EBO	210 30	THD 425, TFS 1305	400 30	<b>SKIL</b>	
		Symetric SYM 70/SYM 70 E	216 30	BK 4, BKV 4, BKS 5/6,	450 30	1873, 1131	210 30
		HK 85 EB	230 30	FSG 165 K, MKS 185 E,		1524 H, 1526 H, 1873 H	210 30
		HK 132 E	350 30	TDH 450/5, FSG 200/240 K		1866 H, 1886 H	230 30
		<b>Güde</b>		170, BKV5	500 30	1525 H, 1985 U, 1986 U	235 30
		GKS 190	190 30	FSG 240, TSG 240	600 30	1899 H	250 30
		GKS 1100 P, KT 210, GUKS	210 30	<b>Makita</b>			
		GKS 210 A	210 30	DCS551Y1J	150 20	<b>Protool</b>	
		GWS 600 EC	220 30	DCS 551 RTJ	150 20	CSP 55/56	160 20
		GTKS 315	315 30	5600 BR/NB/RDW,	160 20	CSP 68	190 30
		QWS 600	600 30	SR 1600		CSP 132	350 30
		GWS 700	700 30	5603 R	165 20		
		GWS 700 EC	700 30	5604 R	165 20		
		GTKS 2200	315 30	5017 RKB	165 30		
		GKS 250 L, TK 2400,	250 20	DHS 630 RTJ/Y1J/ 680 RTJ/	165 20		
		TKGS 1800		Y1J/ Z, DSP 600 ZJ, DLS			
		GFO 1801	254 20	600 Z, HS 6101 J/ J1,			
		GFO 1401	216 30	SP6000 J1/SP1			
		<b>Hitachi</b>		3501, 5800 RB	190 20		
		C6DA, FC6DA	160 20	LS0714FB, DLS713RME/	190 20		
		C6MEY	165 20	DLS713Z/DLS714Z			
		C6 BUM/U3	165 30	DLS 713 RTE	190 20		
				5017 R, 5017RKB	190 30		
				5704 R, 5704RJ	190 30		

Ø Diameter in mm  
Ø Bo Bore diameter in mm

Circular Saw Blades, »power cut«

Circular saw blades for hand-held circular saws



- For coarse and semi-fine cuts with continuous feed. Ideal for high feed rate / low power consumption machines
- Good cutting results for straight cuts in solid wood
- Partially suitable for construction wood with nails and concrete residue
- On coated wood or other composites, only coarse cut quality is possible

Diameter x cutting width x bore mm	Material	Number of teeth	Tooth shape	Steel blade thickness mm	Rake angle	Suitable for	Order no.
152 x 2.4 x 20	HW/CT	12	FZ	1.6	15°	Ks 0852 S	628001000*
160 x 2.2 x 20	HW/CT	10	WZ	1.4	22°	KS 54 / KSE 55 Plus / KSE 55 Vario Plus / KS 55 / KS 55 FS, KS 55 / KS 55 FS	628002000*
190 x 2.6 x 20	HW/CT	14	WZ	1.8	25°	Ks 1266 S / Ks 1468 S	628004000*
190 x 2.2 x 30	HW/CT	14	WZ	1.4	25°	KS 66 / KS 66 Plus / KSE 68 Plus	628005000*
190 x 2.2 x 30	HW/CT	16	FZ/FA	1.4	12°	KS 66 / KS 66 Plus / KSE 68 Plus	628006000*
210 x 2.6 x 30	HW/CT	16	FZ	1.8	25°	Ks E 1678 S-Signal	628007000*
230 x 2.6 x 30	HW/CT	18	FZ/FA	1.8	10°	KS 85	628010000*
230 x 2.6 x 30	HW/CT	24	WZ	1.8	20°	KS 85	628011000*

Circular saw blades for semi-stationary/stationary circular saws



Carbide Tipped Circular Saw Blades

- For coarse and semi-fine cuts with continuous feed. Ideal for high feed rate / low power consumption machines
- Good cutting results for straight cuts in solid wood
- Partially suitable for construction wood with nails and concrete residue
- On coated wood or other composites, only coarse cut quality is possible
- Secondary holder for circular saw blades with Ø 216, 250, 254 and over 300 mm

Diameter x cutting width x bore mm	Material	Number of teeth	Tooth shape	Steel blade thickness mm	Rake angle	Suitable for	Order no.
210 x 1.8 x 30	HW/CT	24	WZ	1.4	5°	KS 210 / KGS 255	628008000*
216 x 2.4 x 30	HW/CT	20	WZ	1.8	5° neg.	KS 216 M Lasercut / KGS 216 M / KGSV 216 M / KGSV 72 Xact / KGSV 72 Xact SYM	628230000*
216 x 2.4 x 30	HW/CT	24	WZ	1.8	5° neg.	KS 216 M Lasercut / KGS 216 M / KGS 216 Plus / KGSV 216 M / KGSV 72 Xact / KGSV 72 Xact SYM	628009000*
250 x 2.8 x 30	HW/CT	24	WZ	2	25°	PKU 250 / PK 255 / PKF 255 / PKF 255 V8 / Multi 260 / Multi 310 / PK 250	628012000*
250 x 2.8 x 30	HW/CT	24	WZ	2	3° neg.	KS 250, KGS 301 / KGS 303 / KGS 331	628013000*
254 x 2.4 x 30	HW/CT	24	WZ	1.6	20°	TS 254 / TK 250 / TS 36 LTX BL 254 / TS 36-18 LTX BL 254	628025000*
254 x 2.4 x 30	HW/CT	24	WZ	1.8	5° neg.	KS 254 Plus / KGS 254 M / KGS 254 Plus / KGS 254 I Plus	628220000*
300 x 2.8 x 30	HW/CT	28	WZ	1.8	15°	PK 300 / PKV 300 G to 1996	628014000*
315 x 2.8 x 30	HW/CT	20	FZ	1.8	22°	TKHS 315 / KGT 300	628015000*
315 x 3 x 30	HW/CT	24	WZ	2	20°	TKHS 315	628016000*
350 x 2.8 x 30	HW/CT	22	FZ	1.8	22°	TK 350 to 1983	628017000*
400 x 3.5 x 30	HW/CT	28	FZ/FA	2.5	10°	BKS 400 Plus	628018000
400 x 3.5 x 30	HW/CT	60	WZ	2.5	15°	BKS 400 Plus	628019000
450 x 3.5 x 30	HW/CT	32	FZ/FA	2.5	10°	BKS 450 Plus / BKH 450 Plus	628020000
450 x 3.8 x 30	HW/CT	66	WZ	2.8	15°	BKS 450 Plus / BKH 450 Plus	628021000
600 x 3.8 x 30	HW/CT	36	WZ	2.8		BW 600	628023000
700 x 4.2 x 30	HW/CT	42	WZ	3.2		BW 750 / BW 700 to 1993	628024000

\*Self-service packaging





**Chrome-vanadium Circular Saw Blades**

- For coarse and semi-fine cuts with continuous feed. Ideal for high feed rate / low power consumption machines
- Good cutting results for straight cuts in solid wood
- Partially suitable for construction wood with nails and concrete residue
- On coated wood or other composites, only coarse cut quality is possible

Diameter x cutting width x bore mm	Material	Number of teeth	Tooth shape	Steel blade thickness mm	Rake angle	Suitable for	Order no.
315 x 1.8 x 30	CV	56	KV	1.8		TKHS 315	628100000
315 x 1.8 x 30	CV	80	NV	1.8		TKHS 315	628101000
350 x 1.8 x 30	CV	56	NV	1.8		TK 350 to 1983	628102000
400 x 2 x 30	CV	56	KV	2		BKS 400 Plus	628105000
500 x 2.5 x 30	CV	56	KV	2.5		BW 500 to 1998	628108000
600 x 2.8 x 30	CV	56	KV	2.8		BW 600	628109000
700 x 2.8 x 30	CV	56	KV	2.8		BW 750 / BW 700 to 1993	628110000
450 x 2.2 x 30	CV	56	WZ	2.2		BKS 450 Plus / BKH 450 Plus	628094000

**Circular Saw Blades, »precision cut«**

**Circular saw blades for hand-held circular saws**



- Very wide range of uses in woodworking
- For very good, clean cut results for longitudinal or cross-cuts in softwood and hardwood
- Well suited for hard wood and plywood, untreated chipboards, coated or veneered, MDF, composite materials
- High power consumption so the saw must have a high performance motor

Diameter x cutting width x bore mm	Material	Number of teeth	Tooth shape	Steel blade thickness mm	Rake angle	Suitable for	Order no.
160 x 1.6 x 20 / 16	HW/CT	24	WZ	1.1	22°	KSAP 18, KSA 18 LTX	628030000*
160 x 2.2 x 20	HW/CT	24	WZ	1.4	20°	KS 54 / KSE 55 Plus / KSE 55 Vario Plus / KS 55 / KS 55 FS	628031000*
167 x 2.4 x 20	HW/CT	20	WZ	1.6	20°	Ks 1155 S	628032000*
167 x 2.4 x 20	HW/CT	40	WZ	1.6	10°	Ks 1155 S	628033000*
190 x 2.6 x 20	HW/CT	48	WZ	1.8	10°	Ks 1266 S / Ks 1468 S	628034000*
190 x 2.2 x 30	HW/CT	48	WZ	1.4	15°	KS 66 / KS 66 Plus / KSE 68 Plus	628035000*
210 x 2.6 x 30	HW/CT	56	WZ	1.8	10°	Ks E 1678 S-Signal	628040000*
230 x 2.6 x 30	HW/CT	56	WZ	1.8	15°	KS 85	628044000*

**Circular saw blades for semi-stationary/stationary circular saws**



- Very wide range of uses in woodworking
- For very good, clean cut results for longitudinal or cross-cuts in softwood and hardwood
- Well suited for hard wood and plywood, untreated chipboards, coated or veneered, MDF, composite materials
- High power consumption so the saw must have a high performance motor
- Secondary holder for circular saw blades with Ø 216, 250, 254 and over 300 mm

Diameter x cutting width x bore mm	Material	Number of teeth	Tooth shape	Steel blade thickness mm	Rake angle	Suitable for	Order no.
210 x 2.4 x 30	HW/CT	30	WZ	1.6	22°	PK 200 / UK 220	628036000*
210 x 2.4 x 30	HW/CT	40	WZ	1.8	3°	KS 210 / KGS 255 / PK 200 / UK 220	628037000*
210 x 2.8 x 30	HW/CT	42	FZ/TZ	1.8	1° neg.	KS 210 / KGS 255 / PK 200 / UK 220	628038000*
210 x 2.4 x 30	HW/CT	42	WZ	1.6	22°	PK 200 / UK 220	628039000*
216 x 2.4 x 30	HW/CT	48	WZ	1.8	5° neg.	KS 216 M Lasercut / KGS 216 M / KGS 216 Plus / KGSV 216 M / KGSV 72 Xact / KGSV 72 Xact SYM	628041000*

Diameter x cutting width x bore mm	Material	Number of teeth	Tooth shape	Steel blade thickness mm	Rake angle	Suitable for	Order no.
220 x 2.4 x 30	HW/CT	36	WZ	1.6	10°	UK 290 / UK 333 / Secanta	628042000*
220 x 2.6 x 30	HW/CT	48	DZ/HZ	1.6	10°	UK 290 / UK 333 / Secanta	628043000*
250 x 2.8 x 30	HW/CT	34	WZ	1.8	15°	KGT 500 / KGT 501 / KGT 550, / PKU 250 / PK 255 / PKF 255 / PKF 255 V8 / Multi 260 / Multi 310	628045000*
250 x 2.8 x 30	HW/CT	42	WZ	1.8	15°	KGT 500 / KGT 501 / KGT 550, PKU 250 / PK 255 / PKF 255 / PKF 255 V8 / Multi 260 / Multi 310 / PK 250	628046000*
250 x 2.4 x 30	HW/CT	60	WZ	1.8	5° neg.	KS 250, KGS 301 / KGS 303 / KGS 331	628048000*
250 x 2.8 x 30	HW/CT	60	WZ	1.8	15°	TS 250 / PKU 250 / PK 255 / PKF 255 / PKF 255 V8 / Multi 260 / Multi 310 / PK 250	628049000*
254 x 2.4 x 30	HW/CT	40	WZ	1.6	20°	TS 254 / TK 250 / TS 36 LTX BL 254 / TS 36-18 LTX BL 254	628059000*
254 x 2.4 x 30	HW/CT	48	WZ	1.8	5° neg.	KS 254 Plus / KGS 254 M / KGS 254 Plus / KGS 254 I Plus	628221000*
254 x 2.4 x 30	HW/CT	60	WZ	1.8	5° neg.	KS 254 Plus / KGS 254 M / KGS 254 Plus / KGS 254 I Plus	628222000*
300 x 2.8 x 30	HW/CT	48	WZ	1.8	15°	PK 300 / PKV 300 G to 1996	628051000*
300 x 2.8 x 30	HW/CT	72	WZ	1.8	10°	PK 300 / PKV 300 G to 1996	628053000*
305 x 2.4 x 30	HW/CT	48	WZ	1.8	5° neg.	KS 305 Plus / KGS 305 / KS 305 M / KGS 305 M / KGT 305 M	628227000*
305 x 2.4 x 30	HW/CT	60	WZ	1.8	5° neg.	KS 305 Plus / KGS 305 / KS 305 M / KGS 305 M / KGT 305 M	628228000*
305 x 2.4 x 30	HW/CT	84	WZ	1.8	5° neg.	KS 305 Plus / KGS 305 / KS 305 M / KGS 305 M / KGT 305 M	628229000*
305 x 2.4 x 30	HW/CT	60	WZ	1.8	1.5°	KGS 305	628054000*
305 x 2.4 x 30	HW/CT	80	WZ	1.8	5°	KGS 305	628055000*
315 x 2.4 x 30	HW/CT	48	WZ	1.8	5° neg.	KGS 315 Plus / KGS 305	628224000*
315 x 2.4 x 30	HW/CT	84	WZ	1.8	5° neg.	KGS 315 Plus / KGS 305	628225000*
315 x 2.8 x 30	HW/CT	48	WZ	1.8	15°	TKHS 315	628056000*
315 x 2.8 x 30	HW/CT	48	WZ	1.8	0°	KGS 305 / KGT 300 / TKHS 315	628057000*
315 x 2.8 x 30	HW/CT	84	WZ	1.8	10°	KGT 300 / TKHS 315	628058000*

**Circular saw blades »Classic«**



- Very wide range of uses in woodworking
- For very good, clean cut results for longitudinal or cross-cuts in softwood and hardwood
- Well suited for hard wood and plywood, untreated chipboards, coated or veneered, MDF, composite materials

Diameter x cutting width x bore mm	Material	Number of teeth	Tooth shape	Steel blade thickness mm	Rake angle	Suitable for	Order no.
165 x 1.8 x 20	HW/CT	18	WZ	1.2	20°	KS 18 LTX 57	628272000*
216 x 2.4 x 30	HW/CT	40	WZ	1.8	5° neg.	KS 216 M Lasercut / KGS 216 M / KGSV 216 M / KGSV 72 Xact / KGSV 72 Xact SYM	628060000*
216 x 1.8 x 30	HW/CT	40	WZ	1.2	5°	KS 18 LTX 216 / KGS 18 LTX 216	628065000*
216 x 2.4 x 30	HW/CT	30	WZ	1.6	22°	TS 216 / TS 216 Floor	628062000*
254 x 2.4 x 30	HW/CT	48	WZ	1.8	5° neg.	KGS 254 M	628061000*
305 x 2.4 x 30	HW/CT	56	WZ	1.6	5° neg.	KS 305 M / KGS 305 M / KGT 305 M	628064000*

\*Self-service packaging

Circular Saw Blades, »multi cut«

Circular saw blades for hand-held circular saws



- Universal use for demanding materials
- For the highest standards in cutting quality, e.g. for laminate, thin-walled plastic, aluminium, copper and bronze materials
- Ideally suited for many interior development applications
- Perfect cutting results, also for cross-cuts in solid wood, coarse, coated or veneered chipboards, MDF
- The circular saw must have a very high performance power
- Relatively slow saw advance

Diameter x cutting width x bore mm	Material	Number of teeth	Tooth shape	Steel blade thickness mm	Rake angle	Suitable for	Order no.
150 x 2.4 x 20	HW/CT	36	WZ	1.6	10°	Ks 0852 S	628000000*
152 x 2.4 x 20	HW/CT	54	FZ/TZ	1.6	5° neg.	Ks 0852 S	628070000*
160 x 2.2 x 20	HW/CT	30	WZ	1.4	5°	KS 54 / KSE 55 Plus / KSE 55 Vario Plus / KS 55 / KS 55 FS	628071000*
160 x 2.2 x 20	HW/CT	42	WZ	1.4	15°	KS 54 / KSE 55 Plus / KSE 55 Vario Plus / KS 55 / KS 55 FS	628072000*
160 x 2.2 x 20	HW/CT	54	FZ/TZ	1.4	8°	KS 54 / KSE 55 Plus / KSE 55 Vario Plus / KS 55 / KS 55 FS	628073000*
167 x 2.4 x 20	HW/CT	42	FZ/TZ	1.6	6° neg.	Ks 1155 S	628074000*
190 x 2.2 x 30	HW/CT	36	WZ	1.4	5°	KS 66 / KS 66 Plus / KSE 68 Plus	628075000*
190 x 2.6 x 20	HW/CT	54	FZ/TZ	1.8	5° neg.	Ks 1266 S / Ks 1468 S	628076000*
190 x 2.2 x 30	HW/CT	56	FZ/TZ	1.4	8°	KS 66 / KS 66 Plus / KSE 68 Plus	628077000*
230 x 2.6 x 30	HW/CT	60	WZ	1.8	5°	KS 85	628085000*

Circular saw blades for semi-stationary/stationary circular saws



- Universal use for demanding materials
- For the highest standards in cutting quality, e.g. for laminate, thin-walled plastic, aluminium, copper and bronze materials
- Ideally suited for many interior development applications
- Perfect cutting results, also for cross-cuts in solid wood, coarse, coated or veneered chipboards, MDF
- The circular saw must have a very high performance power
- Relatively slow saw advance
- Secondary holder for circular saw blades with Ø 216, 250, 254 and over 300 mm (except 628063000)

Diameter x cutting width x bore mm	Material	Number of teeth	Tooth shape	Steel blade thickness mm	Rake angle	Suitable for	Order no.
210 x 2.6 x 30	HW/CT	54	FZ/TZ	1.8	5° neg.	KS 210 / KGS 255 / Ks E 1678 S-Signal	628078000*
210 x 2.8 x 30	HW/CT	60	WZ	2	5° neg.	KS 210 / KGS 255 / Ks E 1678 S-Signal	628079000*
210 x 2.4 x 30	HW/CT	64	WZ	1.6	10°	PK 200 / UK 220	628081000*
210 x 2.4 x 30	HW/CT	64	FZ/TZ	1.6	5° neg.	KS 210 / KGS 255	628082000*
216 x 2.4 x 30	HW/CT	60	FZ/TZ	1.8	5° neg.	KS 216 M Lasercut / KGS 216 M / KGS 216 Plus / KGSV 216 M / KGSV 72 Xact / KGSV 72 Xact SYM	628083000*
216 x 2.4 x 30	HW/CT	64	FZ/TZ	1.6	10°	TS 216 / TS 216 Floor	628063000*
220 x 2.6 x 30	HW/CT	80	FZ/TZ	1.6	10°	UK 290 / UK 333 / Secanta	628084000*
250 x 2.8 x 30	HW/CT	80	WZ	1.8	10°	KGT 500 / KGT 501 / KGT 550 / TS 250 / PKU 250 / PK 255 / PKF 255 / PKF 255 V8 / Multi 260 / Multi 310	628087000*
250 x 2.8 x 30	HW/CT	80	FZ/TZ	2	5° neg.	KGS 301 / KGS 303 / KGS 331 / KGT 500 / KGT 501 / KGT 550 / TS 250, PKU 250 / PK 255 / PKF 255 / PKF 255 V8 / Multi 260 / Multi 310	628088000*
254 x 2.4 x 30	HW/CT	80	FZ/TZ	1.6	5°	TS 254 / TK 250 / TS 36 LTX BL 254 / TS 36-18 LTX BL 254	628093000*
254 x 2.4 x 30	HW/CT	80	FZ/TZ	1.8	5° neg.	KS 254 Plus / KGS 254 M / KGS 254 Plus / KGS 254 I Plus	628223000*
300 x 2.8 x 30	HW/CT	96	FZ/TZ	2.2	6° neg.	PK 300 / PKV 300 G to 1996	628090000*
305 x 2.8 x 30	HW/CT	96	FZ/TZ	2	5° neg.	KGS 305 / KS 305 Plus / KS 305 M / KGS 305 M / KGT 305 M	628091000*
315 x 2.4 x 30	HW/CT	96	FZ/TZ	1.8	5° neg.	KGS 315 Plus / KGS 305	628226000*
315 x 2.8 x 30	HW/CT	96	FZ/TZ	2	5° neg.	KGS 305	628092000*

Circular saw blades »Classic« for semi-stationary/stationary circular saws



- Universal use for demanding materials
- For high standards in cutting quality, e.g. for laminate, thin-walled plastic, aluminium, copper and brass materials
- Well suited for many interior development applications
- Very good cutting results, also for cross-cuts in solid wood, coarse, coated or veneered chipboards, MDF
- The circular saw must have a very high performance power
- Relatively slow saw advance

Diameter x cutting width x bore mm	Material	Number of teeth	Tooth shape	Steel blade thickness mm	Rake angle	Suitable for	Order no.
216 x 2.4 x 30	HW/CT	60	FZ/TZ	1.8	5° neg.	KGSV 216 M / KS 216 M Lasercut / KGS 216 M / KGS 216 Plus / KGSV 72 Xact / KGSV 72 Xact SYM	628066000*

Reducing Bushes for Circular Saw Blades



Order no.
623545000
623546000
623547000
623548000
623549000
623550000*
623551000*

**Reducing bush**

- Ø 20 x 1.2 x 16 mm
- For circular saw blades with a steel blade thickness of 1.25 mm - max. 1.6 mm

**Reducing bush**

- Ø 30 x 1.2 x 16 mm
- For circular saw blades with a steel blade thickness of 1.25 mm - max. 1.6 mm

**Reducing bush**

- Ø 30 x 1.2 x 20 mm
- For circular saw blades with a steel blade thickness of 1.25 mm - max. 1.6 mm

**Reducing bush**

- Ø 30 x 1.2 x 25 mm
- For circular saw blades with a steel blade thickness of 1.25 mm - max. 1.6 mm

**Reducing bush**

- Ø 30 x 1.6 x 16 mm
- For circular saw blades with a steel blade thickness of 1.65 mm - max. 2.2 mm

**Reducing bush**





- Ø 30 x 1.6 x 20 mm
- For circular saw blades with a steel blade thickness of 1.65 mm - max. 2.2 mm



**Reducing bush**

- Ø 30 x 1.6 x 25 mm
- For circular saw blades with a steel blade thickness of 1.65 mm - max. 2.2 mm

\*Self-service packaging

Other Accessories for Circular Saws

Guide rails FS	
<ul style="list-style-type: none"> <li>For straight and secure guidance</li> <li>Splinter protection reduces tears when sawing</li> <li>Adhesive coating for safe, non-slip surface contact as well as protection of the workpiece surface</li> <li>With bores to fix the rail to the workpiece and for hanging storage</li> <li>Can be extended in length with the second guide rail and FSV connector (accessory)</li> <li>Suitable for Metabo hand-held circular saws</li> </ul>	
<b>NEW</b> 	<b>Guide Rail FS 80</b> (available from September 2018) Length: 80 cm Order no. 629010000*
<b>NEW</b> 	<b>Guide Rail FS 160</b> (available from September 2018) Length: 160 cm Order no. 629011000*
<b>NEW</b> 	<b>Guide Rail FS 160</b> (available from September 2018) With practical carry bag for safe storage and transport Length: 160 cm Order no. 629011700*
<b>NEW</b> 	<b>Guide Rail FS 250</b> (available from September 2018) Length: 250 cm Order no. 629013000
<b>NEW</b> 	<b>Guide Rail FS 310</b> (available from September 2018) Length: 310 cm Order no. 629014000

Guide rail 631213	
<ul style="list-style-type: none"> <li>Guide rail made of sturdy, anodised aluminium extrusion</li> <li>Anti-slip backing provides safe and reliable support and protects the work piece surface against scratches</li> <li>Guide rule, adjustable to eliminate play</li> </ul>	
	<b>Guide rail 631213</b> suitable for: Metabo jigsaws, hand-held circular saws and router models OFE 738 and Of E 1229 Signal (when using the appropriate accessories; KS 55 FS, KSE 55 Vario Plus, KS 66 Plus, KSE 68 Plus can be used directly); also suitable for the CED 125 Plus dust extraction shroud in connection with an angle grinder Overall length: 150 cm Order no. 631213000
	<b>Connector</b> <ul style="list-style-type: none"> <li>For the trouble-free joining together of two precision guide rails</li> <li>Can only be used with guide rail 631213000</li> </ul> Order no. 631211000*

Accessories for guide rails	
	<b>Quick tensioning clamp FSSZ</b> (available from September 2018) <ul style="list-style-type: none"> <li>For quick and safe fixing of guide rails from Metabo and other manufacturers</li> <li>Solid hold even in case of vibrations</li> <li>160 mm clamping height</li> </ul> Order no. 629021000*
	<b>2 Tensioning clamps FSZ</b> <ul style="list-style-type: none"> <li>For the attachment of the guide rails on the workpiece or the workbench</li> </ul> Order no. 631031000*
<b>NEW</b> 	<b>Mitre Fence FSW</b> (available from September 2018) <ul style="list-style-type: none"> <li>For precise alignment of the guide rail on the workpiece</li> <li>Angle adjustable from -60° to +60°</li> <li>Suitable for the Metabo guide rails FS</li> </ul> Order no. 629026000
<b>NEW</b> 	<b>Connector FSV</b> (available from September 2018) <ul style="list-style-type: none"> <li>For the trouble-free joining together of two precision guide rails</li> <li>Can be pushed into the guide rail for storage</li> <li>Suitable for the Metabo guide rails FS</li> </ul> Order no. 629022000
	<b>Splinter protection FSS</b> (available from September 2018) <ul style="list-style-type: none"> <li>Reduces tears in the workpiece</li> <li>Roll with 3.5 m (as replacement)</li> <li>Suitable for the Metabo guide rails FS</li> </ul> Order no. 629023000*
<b>NEW</b> 	<b>Sliding coating FSG</b> (available from September 2018) <ul style="list-style-type: none"> <li>For easy gliding on the guide rail</li> <li>Roll with 7 m (as replacement)</li> <li>Suitable for the Metabo guide rails FS</li> </ul> Order no. 629024000*
	<b>Adhesive coating FSH</b> (available from September 2018) <ul style="list-style-type: none"> <li>For safe, non-slip hold as well as protection of the workpiece surface</li> <li>Roll with 7 m (as replacement)</li> <li>Suitable for the Metabo guide rails FS</li> </ul> Order no. 629025000*
<b>NEW</b> 	<b>Bag FST</b> (available from September 2018) <ul style="list-style-type: none"> <li>Handy carry bag for safe storage and transport of the guide rail up to 160 cm</li> <li>Suitable for the Metabo guide rail FS 160</li> </ul> Order no. 629020000
	<b>Guide plate</b> <ul style="list-style-type: none"> <li>For use of the circular saws KSA 18 LTX, KSAP 18, KS 54 and KS 54 SP on the guide rails</li> <li>Complete guide plate with 2 mounted aluminium threaded bushes for the circular saws</li> </ul> Order no. 631019000
	<b>Adapter</b> <ul style="list-style-type: none"> <li>For use with the KS 66 and KSE 68 Plus hand-held circular saws (old; order no. 600543) on the guide rails</li> </ul> Order no. 631020000
Sawdust ejection nozzle and suction hose	
	<b>Sawdust ejection nozzle</b> <ul style="list-style-type: none"> <li>Can be rotated</li> <li>For fitting the suction hose to the circular saw KS 54 and KSE 55 Plus</li> </ul> Order no. 630924000*
	<b>Suction hose</b> <ul style="list-style-type: none"> <li>With bayonet fitting and rubber connector (internal Ø 30 mm, outside Ø 35 mm)</li> <li>Connector Ø: 58 mm</li> <li>Hose length: 3.5 m</li> <li>Suction hose Ø: 27 mm</li> </ul> Order no. 631938000

\*Self-service packaging

18 V



Technical data	Cordless Jigsaw STAB 18 LTX 100	Cordless Jigsaw STA 18 LTX 100	Cordless Jigsaw STA 18 LTX 140
Type of battery pack	Li-Ion / LiHD	Li-Ion / LiHD	Li-Ion / LiHD
Battery pack voltage	18 V	18 V	18 V
Cutting depth wood	100 mm	100 mm	140 mm
Cutting depth NF metal	25 mm	25 mm	35 mm
Cutting depth sheet steel	10 mm	10 mm	10 mm
Swivel range from / to:	- 45 °/+ 45 °	- 45 °/+ 45 °	- 45 °/+ 45 °
Pendulum stroke levels	4	4	4
Strokes in idle	0 - 2,800 /min	550 - 2,800 /min	1,000 - 3,000 /min
Weight (including battery pack)	2.5 kg	2.4 kg	2.8 kg

Scope of delivery	601003	601002	601405
Order no.	601003	601002	601405
Extraction nozzles	■	■	■
Protective glass	■	■	■
Plastic guard plate			■
Chip guard plates	■	■	■
Jigsaw blade	■	■	
Hexagonal wrench	■	■	
2 LiHD battery packs (18 V/4.0 Ah)	■	■	■
Charger ASC 30-36 V »AIR COOLED«	■	■	■
Plastic carry case	■	■	■

Equipment variants can be found in the Metabo price list and on the internet

- Product advantages**
- Top handle with non-slip soft-grip surface
  - Extremely powerful jigsaw with VTC-Electronics for fast cuts into soft wood of up to 140 mm deep
  - Convenient auto start with automatic stroke rate acceleration
  - Integrated LED work light for illumination of the cutting line
  - Long service life thanks to optimum gear and motor design and robust die-cast aluminium gear housing
  - Extremely handy due to small body circumference and soft-grip surface
  - Precise and material-matched sawing due to the variable stroke rate, pendulum stroke and low-lying saw blade guidance with spring support
  - Metabo Quick for tool-free saw blade change and with automatic ejection
  - Selectable chip blowing function ensures free view of cutting line
  - Battery packs with capacity display for checking the charge status

**System components**

- Accessories → 391
- Battery packs → 72
- Extraction systems → 453



Technical data	Jigsaw STEB 65 Quick	Jigsaw STEB 70 Quick	Jigsaw STEB 80 Quick	Jigsaw STE 100 Quick
Rated input power	450 W	570 W	590 W	710 W
Output power	230 W	335 W	350 W	470 W
Cutting depth wood	65 mm	70 mm	80 mm	100 mm
Cutting depth NF metal	18 mm	20 mm	25 mm	25 mm
Cutting depth sheet steel	6 mm	6 mm	8 mm	10 mm
Swivel range from / to:	- 45 °/+ 45 °	- 45 °/+ 45 °	- 45 °/+ 45 °	- 45 °/+ 45 °
Pendulum stroke levels	4	4	4	4
Strokes in idle	600 - 3,000 /min	900 - 3,300 /min	900 - 3,300 /min	1,000 - 3,100 /min
Saw blade stroke	18 mm	22 mm	22 mm	22 mm
Weight (without mains cable)	1.9 kg	2 kg	2 kg	2 kg
Cable length	2.5 m	2.4 m	2.4 m	4 m

Scope of delivery	601030 <sup>1) 2)</sup>	601040	601041	601100
Order no.	601030 <sup>1) 2)</sup>	601040	601041	601100
Extraction nozzles				■
Protective glass	■	■	■	■
Chip guard plates		■	■	
Jigsaw blade wood	■			
Jigsaw blade metal	■			
Hexagonal wrench	■	■	■	■
Plastic carry case	■	■	■	

Equipment variants can be found in the Metabo price list and on the internet  
<sup>1)</sup> also available in 120 V (North/Latin America)  
<sup>2)</sup> also available in 110 V (UK)

- Product advantages**
- Chip blowing function for clear view of cutting line
  - Extremely slim jigsaw for perfect handling in any application
  - Vario-Tacho-Constamatic (VTC)-Full Wave Electronics for work with materials requiring customised stroke rates, which remain almost constant under load
  - Metabo Quick for changing saw blades without tools
  - Top handle with non-slip soft-grip surface
  - Variospeed (V) Electronics for working with customised stroke rates for the materials used
  - Low-lying saw blade guidance for precise cuts
  - Metabo Quick for tool-free saw blade change and with automatic ejection
  - Selectable chip blowing function ensures free view of cutting line
  - Precision guide rail and guiding device available as accessory

**System components**

- Accessories → 391
- Extraction systems → 453
- Extraction possibility by means of connecting an all-purpose vacuum cleaner



Technical data	Jigsaw STE 140	Jigsaw STEB 140	Jigsaw STE 140 Plus	Jigsaw STEB 140 Plus
Rated input power	750 W	750 W	750 W	750 W
Output power	420 W	420 W	420 W	420 W
Cutting depth wood	140 mm	140 mm	140 mm	140 mm
Cutting depth NF metal	35 mm	35 mm	35 mm	35 mm
Cutting depth sheet steel	10 mm	10 mm	10 mm	10 mm
Swivel range from / to:	- 45 °/+ 45 °	- 45 °/+ 45 °	- 45 °/+ 45 °	- 45 °/+ 45 °
Pendulum stroke levels	4	4	4	4
Strokes in idle	1,000 - 3,100 /min	1,000 - 3,100 /min	1,000 - 3,100 /min	1,000 - 3,100 /min
Saw blade stroke	26 mm	26 mm	26 mm	26 mm
Weight (without mains cable)	2.5 kg	2.5 kg	2.5 kg	2.6 kg
Cable length	4 m	4 m	4 m	4 m

Scope of delivery

Order no.	601401	601402 <sup>1)</sup>	601403	601404 <sup>2)</sup>
Extraction nozzles			■	■
Protective glass			■	■
Plastic guard plate			■	■
Chip guard plates			■	■
Hexagonal wrench	■	■		
Plastic carry case			■	■

Equipment variants can be found in the Metabo price list and on the internet

<sup>1)</sup> also available in 120 V (North/Latin America)

<sup>2)</sup> also available in 110 V (UK)

Product advantages

- Extremely handy due to small body circumference and soft-grip surface
- Extremely handy due to small body circumference and soft-grip surface
- Convenient auto start with automatic stroke rate acceleration
- Simple bevel cuts thanks to footplate with rest points that can be adjusted without tools
- Motion-controlled LED work light for optimum illumination of the cutting line
- Restart protection: prevents unintentional start-up after power supply interruption
- Extremely powerful jigsaw with VTC-Electronics for fast cuts into soft wood of up to 140 mm deep
- Precise and material-matched sawing due to the variable stroke rate, pendulum stroke and low-lying saw blade guidance with spring support
- Metabo Quick for tool-free saw blade change and with automatic ejection
- Selectable chip blowing function ensures free view of cutting line
- Vario Tacho Constamatic (VTC) Full-wave Electronics for work with materials requiring customised stroke rates, which remain constant under load
- Long service life thanks to optimum gear and motor design and robust die-cast aluminium gear housing

System components

Accessories → 391

Extraction systems → 453

Jigsaw blades



Features of the Metabo jigsaw blades

Colour

The colour indicates for which material the blade is best suited.

<b>Yellow</b>	For wood
<b>Yellow with blue lettering</b>	For wood with nails
<b>Blue</b>	For metal
<b>Black</b>	For special applications

Basic blade material

**HCS** Carbon steel, for cutting soft wood, hardboards, plastics  
**HSS** High yielding high-speed steel, suitable for metal, aluminium work  
**BiM** Bi-metal is an especially flexible mix of HCS and HSS. The saw blades have a much higher service life than HCS and HSS and have proven their worth when there is risk of the shaft breaking  
**Carbide** Carbide, these particularly high performing saw blades are suitable for stainless steel, fibreglass reinforced plastic, gypsum plaster or cement fibre boards. Saw blades with a carbide coating are suitable to cut ceramic tiles

Quality classes

<b>»classic« series</b>	Good work results with very good tool life
<b>»professional« series</b>	Fast, clean and precise angle-cutting with long service life
<b>»pionier« series</b>	Fast through all materials
<b>»expert« series</b>	For special applications



<b>Teeth milled, offset for clearance gap</b> A relatively rough cut, fast progress in cutting on hard and soft wood, aluminium, non-ferrous metals and plastics	<b>Teeth milled, waved for clearance gap</b> A fine cut with straight tool guidance in hard and soft wood, aluminium, non-ferrous metals and plastics	<b>Teeth ground, offset for clearance gap</b> Fast cutting in hard and soft woods	<b>Teeth ground, offset for clearance angle and clearance gap</b> Fine and clean cut in wood and plastics
---------------------------------------------------------------------------------------------------------------------------------------------------------------------	----------------------------------------------------------------------------------------------------------------------------------------------------------	--------------------------------------------------------------------------------------	--------------------------------------------------------------------------------------------------------------

Shank forms

The jigsaw blades from Metabo are produced with all shank forms matching the jigsaws of other brand names.

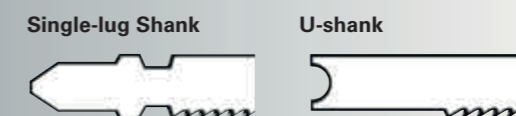

01

02

03

04

05

06

07

08

09

10

11

12

13

14









15

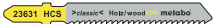
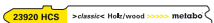

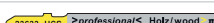
Jigsaw Blades

Jigsaw blades with single-lug shank

■ Suitable for Metabo, AEG, Black & Decker, Bosch, DeWalt, Festool, Hitachi, Holz-Her, Kress, Mafell, Makita, Skil ...

Version	Material	Useable length mm	Thick-ness mm	Tooth pitch	Corresponds to Bosch type	Sales unit	Order no.
<b>for wood, »classic« series</b> Good cutting results with good tool life							
 23631 HCS	Hard wood, soft wood, chipboards, wood-core plywood 2-15 mm, fibre boards 2-15 mm, plastics, insulating material						
Milled, wavy	HCS	51	1	2.0 mm	T 119 B	5	623631000*
 23920 HCS	Hard wood, soft wood, chipboards, wood-core plywood 2-15 mm, fibre boards 2-15 mm, plastic, insulation material, saw blades with immersion tip						
Milled, wavy	HCS	66	1	1.9 - 2.3 mm/ 13-11 TPI/ Progressive	T 119 B	5	623920000*
 23646 HCS	Hard wood, soft wood, chipboards, wood-core plywood 2-20 mm, fibre boards 2-20 mm, plastics, insulating material, especially for curved cuts						
Milled, wavy	HCS	51	1	2.0 mm	T 119 BO	5	623646000*
						25	623605000*
 23632 HCS	Hard wood, soft wood, plastics 4-50 mm, for fast, rough cuts						
Milled, offset	HCS	74	1.25	3.0 mm	T 111 C	5	623632000*
						25	623606000*
<b>for wood, »professional« series</b> Fast, clean and precise with a long tool life							
 23633 HCS	Hard wood, soft wood, chipboards, wood-core plywood 5-50 mm, for quick cuts						
ground, offset	HCS	74	1.25	4.0 mm	T 144 D	3	623964000*
						5	623633000*
						25	623690000*
						100	623712000
 23921 HCS	Hard wood, soft wood, chipboards, wood-core plywood 5-50 mm, for quick cuts, saw blade with plunge tip						
ground, offset	HCS	74	1.25	4-5.2 mm/ 6-5 TPI/ Progressive	T 144 D	5	623921000*
 23649 HCS	Hard wood, soft wood, chipboards, wood-core plywood 5-50 mm, especially for curved cuts						
ground, offset	HCS	74	1.25	4.0 mm	T 244 D	5	623649000*
						25	623607000*
 23960 HCS	Hard wood, soft wood, chipboards, wood-core plywood 5-50 mm, especially for curved cuts, saw blade with plunge tip						
ground, offset	HCS	74	1.25	4-5.2 mm/ 6-5 TPI/ Progressive	T 244 D	5	623960000*
 23676 HCS	Hard wood, soft wood, chipboards, wood-core plywood 2-15 mm, fibre boards, for quick cuts						
ground, offset	HCS	126	1.25	4.0 mm	T 344 D	5	623678000*
 23653 HCS	Hard wood, soft wood, chipboards, wood-core plywood, fibre boards, construction wood, extra thick						
ground, offset	HCS	155	1.5	4.0 mm	T 744 D	5	623603000*
 23651 HCS	Soft wood, plywood, plastics 1.5-5 mm, especially for clean cuts, especially for curved cuts						
Clearance angle offset, pointed teeth	HCS	57	1.25	1.4 mm	T 101 AO	5	623651000*
						25	623624000*

Version	Material	Useable length mm	Thick-ness mm	Tooth pitch	Corresponds to Bosch type	Sales unit	Order no.
 23634 HCS	Hard wood, soft wood, chipboards, wood-core plywood, fibre boards, plastics 3-30 mm, for clean cuts						
Clearance angle offset, tooth ground	HCS	74	1.5	2.5 mm	T 101 B	3	623961000*
						5	623634000*
						25	623691000*
						100	623703000
 23669 HCS	Hard wood, soft wood, chipboards, wood-core plywood, fibre boards, plastics 3-30 mm, for clean cuts, saw blades with plunge tip						
Clearance angle offset, tooth ground	HCS	74	1.5	2.7 mm/ 9 TPI	T 101 B	5	623969000*
 23650 HCS	Hard wood, soft wood, chipboards, wood-core plywood, fibre boards, coated boards 3-30 mm, for clean cuts, Caution: deactivate the pendulum action!						
Clearance angle, tooth ground reverse gearing	HCS	74	1.5	2.5 mm	T 101 BR	5	623650000*
						25	623608000*
 23635 HCS	Hard wood, soft wood, chipboards, wood-core plywood 10-45 mm, fibre boards 10-45 mm, for clean cuts						
Clearance angle offset, tooth ground	HCS	74	1.5	4.0 mm	T 101 D	3	623962000*
						5	623635000*
						25	623609000*
						100	623704000
 23923 HCS	Hard wood, soft wood, chipboards, wood-core plywood 10-45 mm, fibre boards 10-45 mm, for clean cuts, saw blade with plunge tip						
Clearance angle offset, tooth ground	HCS	74	1.5	4-5.2 mm/ 6-5 TPI/ Progressive	T 101 D	5	623923000*
 23654 HCS	Hard wood, soft wood, chipboards, wood-core plywood 4-60 mm, fibre boards 4-60 mm, for clean cuts						
Clearance angle offset, tooth ground	HCS	91	1.5	3.0 mm	T 301 CD	5	623654000*
 22884 HCS	Hard wood, soft wood, doors, kitchen counters 5-50 mm, for precise angle cuts, extra thick						
ground, offset	HCS	74	1.7	4.0 mm	T 144 DP	5	623694000*
 23679 HCS	Hard wood, soft wood, chipboards, wood-core plywood 5-100 mm, fibre boards 5-100 mm, for angle-precise cuts, extra thick						
precision ground, tooth ground	HCS	104	1.7	4.0 mm	T 344 DP	5	623679000*
 23685 HCS	Kitchen counters, hardwood 3-65 mm, softwood 3-65 mm, doors, for precise angle cuts, extra thick						
Clearance angle offset, tooth ground	HCS	91	1.7	2.5 mm	T 301 BCP	5	623685000*
 62398 HCS	Perfect on both sides, splinter-free cutting result, for fast cuts, soft wood, Attention: deactivate pendulum stroke!						
Clearance angle offset, tooth ground	HCS	93	1.5	2.2 mm	T 308 B	5	623998000*
<b>for wood, »professional« series, BiM</b> Fast, clean and precise with a very long tool life							
 23976 BiM	Hard wood, soft wood, coated boards 5-50 mm, for quick cuts						
ground, offset	BiM	74	1.25	4.0 mm	T 144 DF	5	623976000*
 22933 BiM	Hard wood, soft wood, wood with nails, laminated board 5-50 mm, for quick cuts, saw blade with plunge tip						
ground, offset	BiM	74	1.25	4-5.2 mm/ 6-5 TPI/ Progressive	T 144 DF	5	623933000*
 23980 BiM	Hard wood, soft wood, coated boards 5-100 mm, for quick cuts						
ground, offset	BiM	126	1.25	4.0 mm	T 344 DF	5	623980000*
 23695 BiM	Especially for laminate, laminated flooring, hard wood, soft wood, coated boards, plywood, especially for curved cuts, for clean cuts						
Clearance angle offset, tooth ground, pointed teeth	BiM	57	1.25	1.4 mm	T 101 AOF	5	623695000*













\*Self-service packaging

Version	Material	Useable length mm	Thick-ness mm	Tooth pitch	Corresponds to Bosch type	Sales unit	Order no.
<b>23948 BIM</b> »professional« Holz/wood melabo	Especially for laminate, laminated flooring, hard wood, soft wood, coated boards, plastics 2-30 mm, for clean cuts						
Clearance angle offset, tooth ground, pointed teeth	BiM	74	1.25	1.7 mm	T 101 AIF	5	623948000*
<b>23975 BIM</b> »professional« Holz/wood melabo	Hard wood, soft wood, laminated flooring, coated boards, plastics 3-30 mm, for clean cuts, saw blade with plunge tip						
Clearance angle offset, tooth ground	BiM	74	1.25	2.7 mm	T 101 BF	5	623975000*
<b>23846 BIM</b> »professional« Holz/wood melabo	Especially for laminate, laminated flooring, kitchen counters 3-30 mm, coated boards, for clean cuts, Caution: deactivate the pendulum stroke!						
Clearance angle, tooth ground reverse gearing	BiM	74	1.25	2.5 mm	T 101 BRF	5	623686000*
<b>23896 BIM</b> »professional« Holz/wood melabo	Hard wood, soft wood, coated boards 4-60 mm						
Clearance angle offset, tooth ground	BiM	91	1.5	3.0 mm	T 301 CDF	5	623696000*
<b>23977 BIM</b> »professional« Holz/wood melabo	Hard wood, soft wood, chipboards, plywood 5-80 mm, fibreglass boards 5-30 mm, for quick cuts						
Clearance angle offset, tooth ground	BiM	105	1.5	3.0 mm	T 301 CLF	5	623977000*
<b>23849 BIM</b> »professional« Holz/wood melabo	Hard wood, soft wood, wood with nails, non-ferrous metals, plastics						
Ground	BiM	90	1	2.5 mm	T 111 HF	5	623949000*
<b>23999 BIM</b> »professional« Holz/wood melabo	Perfect on both sides, splinter-free cutting result, for fast cuts, hardwood. Attention: deactivate the pendulum stroke!						
Clearance angle offset, tooth ground	BiM	93	1.5	2.2 mm	T 308 BF	5	623999000*
<b>for wood »pionier« series</b> Quick and clean in all wood thicknesses							
<b>23878 HCS</b> »pionier« Holz/wood melabo	Hard wood, soft wood, chipboards, wood-core plywood, fibre boards, for quick cuts						
Clearance angle offset, tooth ground	HCS	91	1.5	2.0-3.0 mm, Progressive	T 234 X	5	623675000*
						25	623617000*
<b>Universal, »pionier« series</b> For wood, metal, plastics							
<b>23377 BIM</b> »pionier« Holz/Metal / wood+metal melabo	Wood, wood with nails, metal, non-ferrous metals, plastics						
Offset, milled	BiM	106	1.25	2.4-5.0 mm, Progressive	T 345 XF	5	623677000*
						25	623621000*
<b>for metal, »classic« series</b> Good cutting results with good tool life							
<b>23636 HSS</b> »classic« Metall/metal melabo	Steel sheets 0.5-1.5 mm, non-ferrous metals						
Milled, wavy	HSS	66	1	0.7 mm	T 118 G	5	623636000*
						25	623693000*
<b>23637 HSS</b> »classic« Metall/metal melabo	Steel sheets 1-3 mm, non-ferrous metals						
Milled, wavy	HSS	51	1	1.2 mm	T 118 A	3	623965000*
						5	623637000*
						25	623692000*
<b>23924 HSS</b> »classic« Metall/metal melabo	Steel sheets 1-3 mm, non-ferrous metals						
Milled, wavy	HSS	66	1	1.1-1.5 mm/ 23-17 TPI/ Progressive	T 118 A	5	623924000*
<b>23647 HSS</b> »classic« Metall/metal melabo	Sheet steel 1-3 mm, non-ferrous metals, especially for curved cuts						
Milled, wavy	HSS	51	1	1.2 mm	T 218 A	5	623647000*

Version	Material	Useable length mm	Thick-ness mm	Tooth pitch	Corresponds to Bosch type	Sales unit	Order no.
<b>23926 HSS</b> »classic« Metall/metal melabo	Sheet steel 1-3 mm, non-ferrous metals, especially for curved cuts, saw blade with plunge tip						
Milled, wavy	HSS	66	1	1.1-1.5 mm/ 23-17 TPI/ Progressive	T 218 A	5	623926000*
<b>23829 HSS</b> »classic« Metall/metal melabo	Steel sheets 1-3 mm, non-ferrous metals, sandwich materials						
Milled, wavy	HSS	106	1	1.2 mm	T 318 A	5	623629000*
						25	623623000*
<b>23838 HSS</b> »classic« Metall/metal melabo	Steel sheets 2.5-6 mm, non-ferrous metals						
Milled, wavy	HSS	51	1	2.0 mm	T 118 B	5	623638000*
						25	623618000*
<b>23925 HSS</b> »classic« Metall/metal melabo	Steel sheets 2.5-6 mm, non-ferrous metals						
Milled, wavy	HSS	66	1	1.9-2.3 mm/ 13-11 TPI/ Progressive	T 118 B	5	623925000*
<b>23887 HSS</b> »classic« Metall/metal melabo	Steel sheets 2.5-6 mm, non-ferrous metals						
Milled, wavy	HSS	106	1	2.0 mm	T 318 B	5	623697000*
<b>for metal, »professional« series</b> Unbreakable, with long tool life							
<b>23871 BIM</b> »professional« Metall/metal melabo	Steel sheets 1-3 mm, non-ferrous metals						
Milled, wavy	BiM	51	1	1.2 mm	T 118 AF	5	623971000*
<b>23950 BIM</b> »professional« Metall/metal melabo	Steel sheets 1-3 mm, non-ferrous metals						
Milled, wavy	BiM	66	1	1.1-1.5 mm/ 23-17 TPI/ Progressive	T 118 AF	5	623950000*
<b>23978 BIM</b> »professional« Metall/metal melabo	Steel sheets 1-3 mm, sandwich materials 2-65 mm, non-ferrous metals, Plexiglas						
Milled, wavy	BiM	106	1	1.1 mm	T 318 AF	5	623978000*
<b>23979 BIM</b> »professional« Metall/metal melabo	Steel sheets 2.5-6 mm, sandwich materials 2-65 mm, non-ferrous metals, Plexiglas						
Milled, wavy	BiM	106	1	1.8 mm	T 318 BF	5	623979000*
<b>23870 BIM</b> »professional« Metall/metal melabo	Sheet steel 1.5 - 4 mm, especially for curved cuts						
Milled, wavy	BiM	57	1.25	1.5 mm	T 118 EOF	5	623970000*
<b>23873 BIM</b> »professional« Metall/metal melabo	Steel sheets 2.5-6 mm, non-ferrous metals						
Milled, wavy	BiM	51	1	2.0 mm	T 118 BF	5	623973000*
<b>23829 BIM</b> »professional« Metall/metal melabo	Sheet steel 1-3 mm, non-ferrous metals, saw blade with plunge tip						
Milled, wavy	BiM	66	1	1.9-2.3 mm/ 13-11 TPI/ Progressive	T 118 BF	5	623929000*
<b>23884 BIM</b> »professional« Sandwich Material melabo	Steel sheets 2.5-6 mm, sandwich materials 2-120 mm, non-ferrous metals, Plexiglas						
Milled, offset	BiM	150	1.25	2.0 mm	T 718 BF	5	623604000*
<b>23972 BIM</b> »professional« Metall/metal melabo	Steel sheets 2-5 mm, non-ferrous metals						
Milled, wavy	BiM	50	1	1.5 mm	T 118 EF	5	623972000*

\*Self-service packaging







Version	Material	Useable length mm	Thick-ness mm	Tooth pitch	Corresponds to Bosch type	Sales unit	Order no.
<b>for metal, »pionier« series</b> Quick and clean in all material thicknesses							
							
Steel sheets 1.5-10 mm, non-ferrous metals to 30 mm							
Milled, offset	BiM	74	1	1.4 - 2.6 mm, Progressive	T 123 XF	5	623676000*
						25	623620000*
<b>for aluminium and non-ferrous metals, »expert« series</b> Especially for aluminium and non-ferrous metals							
							
Aluminium 3-15 mm, non-ferrous metals 4-20 mm, plastics, for quick cuts							
Milled, offset	HSS	74	1	3.0 mm	T 127 D	5	623639000*
						25	623622000*
							
Aluminium 3-15 mm, non-ferrous metals 4-20 mm, especially for curved cuts							
Milled, offset	HSS	74	1	3.0 mm	T 227 D	5	623648000*
							
Aluminium 3-15 mm, non-ferrous metals 4-20 mm, plastics, for quick cuts							
Milled, offset	BiM	75	1	3.0 mm	T 127 DF	5	623974000*
<b>for stainless steel, »expert« series</b> Especially for stainless steel, Inox							
							
Stainless steel sheets (Inox) 1-2 mm, non-ferrous metals							
Ground	HM	57	1	1.1 mm	T 118 AHM	3	623662000*
							
Stainless steel sheets (Inox) 2-4 mm, non-ferrous metals							
Ground	HM	57	1	1.4 mm	T 118 EHM	3	623663000*
<b>For plastics, »expert« series</b> For special applications, e.g. plastics							
							
Fibreglass reinforced plastics, Corian 4-60 mm							
Ground	HM	91	1.25	3.3 mm	T 301 CHM	3	623687000*
<b>for gypsum plaster/cement materials, »expert« series</b> For special applications, e.g. gypsum plaster, cement materials							
							
Gypsum plaster, cement fibre board 5-50 mm, fibreglass reinforced plastics 5-20 mm							
Ground	HM	74	1.25	4.3 mm	T 141 HM	1	623652000*
							
Gypsum plaster, cement fibre board 5-80 mm, fibreglass reinforced plastics 5-50 mm							
Ground	HM	106	1.25	4.3 mm	T 341 HM	1	623688000*
						3	623671000*
<b>for Plexiglas, »expert« series</b> For special applications, e.g. Plexiglas							
							
Plexiglas, polycarbonate 2-20 mm, non-ferrous metals 2-10 mm							
Clearance angle offset, tooth ground	HSS	74	1.25	2.0 mm	T 101 A	5	623640000*
<b>for soft materials, »expert« series</b> For special applications, e.g. soft materials, carton							
							
Polystyrene, cardboard, leather, rubber, carpet up to 50 mm							
Knife ground, straight	HCS	74	1.25		T 113 A	5	623641000*
							
Polystyrene, cardboard, leather, rubber, carpet up to 50 mm							
Blades ground, wavy	HCS	126	1		T 313 AW	3	623684000*

\*Self-service packaging

Version	Material	Useable length mm	Thick-ness mm	Tooth pitch	Corresponds to Bosch type	Sales unit	Order no.
<b>for ceramic materials, »expert« series</b> for special applications, e.g. ceramic materials							
							
Ceramic, glass, fibre glass reinforced plastics, cast iron							
Coarse	Carbide coated	76	0.8	-	T 130 Riff	1	623657000*
							
Ceramic, glass, fibre glass reinforced plastics, cast iron							
fine	Carbide coated	76	0.8	-	T 150 Riff	1	623658000*

Jigsaw blade assortments with single-lug shank







- Suitable for Metabo, AEG, Atlas Copco, Black & Decker, Bosch, DeWalt, Elu, Festool, Hitachi, Holz-Her, Kress, Mafell, Makita, Skil ...

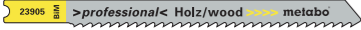

	Order no.
 <p><b>Jigsaw blade assortment 1</b></p> <ul style="list-style-type: none"> <li>■ For wood and metal</li> <li>■ HCS saw blades/HSS saw blade</li> </ul> <p>Consisting of 1 saw blade each 623634000, 623633000, 623637000 Suitable material: wood, metal Number of parts: 3</p>	623968000*
 <p><b>Jigsaw blade assortment 2</b></p> <ul style="list-style-type: none"> <li>■ For wood, metal and plastic</li> <li>■ HCS saw blades/HSS saw blade</li> </ul> <p>Consisting of 1 saw blade each 623633000, 623635000, 623632000, 623631000 und 623637000 Suitable material: wood, plastic, metal Number of parts: 5</p>	623645000*
 <p><b>Jigsaw blade assortment 3</b></p> <ul style="list-style-type: none"> <li>■ For wood, metal and plastic</li> <li>■ HCS saw blades/HSS saw blades</li> </ul> <p>Consisting of 2 saw blades each 623634000, 623633000, 623646000, 623637000, 623638000 Material suitability: Wood, metal, plastics Number of parts: 10</p>	623600000*
 <p><b>Jigsaw blade assortment 4</b></p> <ul style="list-style-type: none"> <li>■ For wood</li> <li>■ HCS saw blades</li> </ul> <p>Consisting of 10 saw blades 623633000 and 623635000 and 5 saw blade 623649000 Suitable material: wood Number of parts: 25</p>	623698000*

Jigsaw blades with universal shank

- Suitable for Black & Decker, Skil, Kress and others

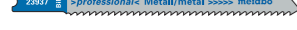
Version	Material	Useable length mm	Thick-ness mm	Tooth pitch	Corresponds to Bosch type	Sales unit	Order no.
<b>for wood, »classic« series</b> Good cutting results with good tool life							
							
Hard wood, soft wood, chipboards, wood-core plywood, fibre boards 5-50 mm, for clean cuts							
Milled, offset	HCS	74	1.25	3.0 mm	U 111 C	5	623945000*

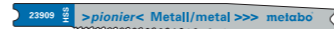









Version	Material	Useable length mm	Thick-ness mm	Tooth pitch	Corresponds to Bosch type	Sales unit	Order no.
<b>for wood, »professional« series</b> Cleaner/quicker cut							
							
Hard wood, soft wood, chipboards, wood-core plywood, fibre boards 5-50 mm							
ground, offset	HCS	82	1.25	4.0 mm	U 144 D	5	623944000*
							
Hard wood, soft wood, plywood, coated board 1.5-15 mm, especially for curved cuts							
Clearance angle offset, pointed teeth	HCS	52	1.25	1.3 mm	U 1 AO	5	623936000*
							
Hard wood, soft wood, chipboards, wood-core plywood, fibre boards 10-45 mm, for clean cuts							
Clearance angle offset, tooth ground	HCS	82	1.25	2.5 mm	U 101 B	5	623943000*
							
Hard wood, soft wood, chipboards, wood-core plywood, fibre boards 3-30 mm, for clean cuts							
Clearance angle offset, tooth ground	HCS	82	1.25	4.0 mm	U 101 D	5	623942000*
<b>for wood, »professional« series, BiM</b> Fast with long tool life							
							
Hard wood, soft wood, chipboards, wood-core plywood, fibre boards 3-30 mm, coated boards, for clean cuts							
Clearance angle offset, tooth ground	BiM	82	1.25	2.5 mm	U 101 BF	5	623905000*
<b>for wood »pionier« series</b> Quick and clean in all wood thicknesses							
							
Hard wood, soft wood, chipboards, wood-core plywood 2-65 mm, for quick cuts							
Clearance angle offset, tooth ground	HCS	90	1.5	2.0-3.0 mm, Progressive	U 234 X	5	623903000*
<b>for wood and metal, »pionier« series</b> For wood, metal, plastics							
							
Wood, wood with nails, metal, non-ferrous metals, plastics							
Milled, offset	BiM	107	1.25	2.4 - 5.0 mm, Progressive	U 345 XF	5	623906000*
<b>for metal, »classic« series</b> Good cutting results with good tool life							
							
Sheet steel, 0.5 - 1.5 mm,							
Milled, wavy	HSS	52	0.8	0.7 mm	U 118 G	5	623938000*
							
Steel sheets 1-3 mm							
Milled, wavy	HSS	52	0.8	1.2 mm	U 118 A	5	623941000*
							
Steel sheets, 2.5-6 mm,							
Milled, wavy	HSS	52	1	2.0 mm	U 118 B	5	623940000*
<b>for metal, »professional« series</b> Unbreakable, with long tool life							
							
Steel sheets 1-3 mm							
Milled, wavy	BiM	52	0.8	1.2 mm	U 118 AF	5	623907000*
							
Steel sheets, 2.5-6 mm,							
Milled, wavy	BiM	74	0.8	2.0 mm	U 118 BF	5	623937000*
<b>for metal, »pionier« series</b> Quick and clean in all material thicknesses							

Version	Material	Useable length mm	Thick-ness mm	Tooth pitch	Corresponds to Bosch type	Sales unit	Order no.
							
Steel sheets 1.5-10 mm, pipes, profiles up to 30 mm							
Milled, offset	BiM	74	1	1.2 - 2.6 mm, Progressive	U 123 XF	5	623909000*
<b>for aluminium and non-ferrous metals, »expert« series</b> Especially for aluminium and non-ferrous metals							
							
Aluminium, non-ferrous metals 3-15 mm, pipes, profiles up to 30 mm							
Milled, offset	HSS	74	1	3.0 mm	U 127 D	5	623939000*

Other Accessories for Jigsaws

	Order no.
 <p><b>Guard plate</b></p> <ul style="list-style-type: none"> <li>For fitting on the base plate of the jigsaw</li> <li>The plastic universal guard plate for protecting all work piece surfaces</li> <li>Guide rail adapter can be coupled on both sides, compatible with Metabo, Mafell and Bosch</li> <li>Rubberised immersion aid for plunge cuts</li> <li>Chip guard plates can be used</li> </ul> <p>suitable for machine: STE 140, STE 140 Plus, STEB 140, STEB 140 Plus, STA 18 LTX 140</p>	623595000*
 <p><b>Guard plate</b></p> <ul style="list-style-type: none"> <li>For fitting on the base plate of the jigsaw</li> <li>The plastic felt guard plate prevents extremely sensitive work piece surfaces from scratches, incl. 3 replacement felts</li> <li>Guide rail adapter can be coupled on both sides, compatible with Metabo, Mafell and Bosch</li> <li>Rubberised immersion aid for plunge cuts</li> <li>Chip guard plates can be used</li> </ul> <p>suitable for machine: STE 140, STE 140 Plus, STEB 140, STEB 140 Plus, STA 18 LTX 140</p>	623596000*
 <p><b>Guard plate</b></p> <ul style="list-style-type: none"> <li>For fitting on the base plate of the jigsaw</li> <li>The durable plastic laminated fabric guard plate (pertainax) for wood or wood-like work piece surfaces</li> <li>Guide rail adapter can be coupled on both sides, compatible with Metabo, Mafell and Bosch</li> <li>Rubberised immersion aid for plunge cuts</li> <li>Chip guard plates can be used</li> </ul> <p>suitable for machine: STE 140, STE 140 Plus, STEB 140, STEB 140 Plus, STA 18 LTX 140</p>	623597000*
 <p><b>Guard plate</b></p> <ul style="list-style-type: none"> <li>For fitting on the base plate of the jigsaw</li> <li>The guard plate protects sensitive work piece surfaces from scratches</li> </ul> <p>suitable for machine: STEB 70 Quick, STEB 80 Quick, STE 90 SCS, STE 100 SCS, STA 18 LTX, STE 100 Plus, STE 135, STE 135 Plus, STEB 135, STEB 135 Plus, STEB 65 Quick, STE 100 Quick, STA 18 LTX 100, STAB 18 LTX 100</p>	623664000*
 <p><b>Circle-cutting and parallel guide</b></p> <ul style="list-style-type: none"> <li>For cutting circles of Ø 100 to Ø 360 mm and for cutting parallel to an edge (maximum distance from the edge 210 mm).</li> </ul> <p>suitable for machine: STE 140, STE 140 Plus, STEB 140, STEB 140 Plus, STA 18 LTX 140, STEB 65 Quick, STEB 65 Quick, STE 100 Quick, STA 18 LTX 100, STAB 18 LTX 100</p>	623591000*
 <p><b>Circle-cutting and parallel guide</b></p> <ul style="list-style-type: none"> <li>For cutting circles of Ø 100 to Ø 360 mm and for cutting parallel to an edge (maximum distance from the edge 210 mm).</li> </ul> <p>suitable for machine: STE 100 Plus, STE 135, STE 135 Plus, STEB 135, STEB 135 Plus, STA 18 LTX, STEB 70 Quick, STEB 80 Quick, STE 90 SCS, STE 100 SCS</p>	631340000*

\*Self-service packaging

	Order no.
 <p><b>Guide rail 631213</b></p> <ul style="list-style-type: none"> <li>■ Guide rail made of sturdy, anodised aluminium extrusion</li> <li>■ Anti-slip backing provides safe and reliable support and protects the work piece surface against scratches</li> <li>■ Guide rule, adjustable to eliminate play</li> </ul> <p>suitable for: Metabo jigsaws, hand-held circular saws and router models OFE 738 and Of E 1229 Signal (when using the appropriate accessories; KS 55 FS, KSE 55 Vario Plus, KS 66 Plus, KSE 68 Plus can be used directly); also suitable for the CED 125 Plus dust extraction shroud in connection with an angle grinder Overall length: 1,500 mm</p>	631213000
 <p><b>Guiding Device</b></p> <ul style="list-style-type: none"> <li>■ For use of the jigsaws in connection with the guide rail 631213</li> </ul> <p>suitable for machine: STEB 70 Quick, STEB 80 Quick, STE 90 SCS, STE 100 SCS, STE 100 Plus, STE 135, STE 135 Plus, STEB 135, STEB 135 Plus, STA 18 LTX</p>	631249000
 <p><b>Connector</b></p> <ul style="list-style-type: none"> <li>■ For the trouble-free joining together of two precision guide rails 631213</li> </ul>	631211000*
 <p><b>2 Tensioning clamps FSZ</b></p> <ul style="list-style-type: none"> <li>■ For fixing the precision guide rail on the work piece or work table</li> </ul>	631031000*
 <p><b>Lubricating / Cooling stick</b></p> <ul style="list-style-type: none"> <li>■ Increase of durability with tools, for example, core drills, magnetic drills, BiM hole saws, router bits or saw blades</li> </ul>	623443000
 <p><b>3 Chip guard plates</b></p> <ul style="list-style-type: none"> <li>■ For splinter-free sawing with the jigsaw</li> </ul> <p>suitable for machine: STE 100 Plus, STE 135, STE 135 Plus, STEB 135, STEB 135 Plus</p>	623665000*
 <p><b>3 Chip guard plates</b></p> <ul style="list-style-type: none"> <li>■ For splinter-free sawing with the jigsaw</li> </ul> <p>suitable for machine: STEB 70 Quick, STEB 80 Quick, STE 90 SCS, STE 100 SCS, STA 18 LTX, ST 50 Pendix, STE 70, STE 80 Quick, STE 140, STE 140 Plus, STEB 140, STEB 140 Plus, STA 18 LTX 140, STEB 65 Quick, STE 100 Quick, STA 18 LTX 100, STAB 18 LTX 100</p>	631208000*
 <p><b>Extraction set</b></p> <ul style="list-style-type: none"> <li>■ Extraction set with corrugated end for safe connection to the Metabo all-purpose vacuum cleaner with suction hose Ø 27 mm and 35 mm.</li> </ul> <p>Suitable for machine: STA 18 LTX 140</p>	623669000*
 <p><b>Extraction set</b></p> <ul style="list-style-type: none"> <li>■ Extraction set with corrugated end for safe connection to the Metabo all-purpose vacuum cleaner with suction hose Ø 27 mm and 35 mm</li> </ul> <p>suitable for machine: STE 140, STE 140 Plus, STEB 140, STEB 140 Plus</p>	623670000*
 <p><b>Suction hose</b></p> <ul style="list-style-type: none"> <li>■ With bayonet fitting and rubber connector (internal Ø 30 mm, outside Ø 35 mm)</li> </ul> <p>Connector Ø: 58 mm Hose length: 3.5 m Suction hose Ø: 27 mm</p>	631938000
 <p><b>Suction hose</b></p> <ul style="list-style-type: none"> <li>■ Anti-static suction hose</li> <li>■ With bayonet fitting and rubber connector (internal Ø 30 mm, outside Ø 35 mm)</li> </ul> <p>Connector Ø: 58 mm / 35 mm Hose length: 3.5 m Suction hose Ø: 27 mm</p>	631939000

\*Self-service packaging

## Robust sabre saws: For powerful sawing.

Few tools offer as much versatility as a sabre saw. In the renovation and building trade it provides the ideal choice for rough cuts such as cutting pipes, wood and insulating boards, or the trimming of aerated blocks and much more. With the SSEP 1400 MVT and the smaller model SSE 1100, Metabo offers two particularly robust and powerful sabre saws.



**Optimal handling**  
thanks to sturdy die-cast aluminium gear housing

**Very demanding applications**  
thanks to powerful 1,400 Watt motor with constant stroke rate

**Metabo Quick** for tool-free saw blade change

**Maximum control**  
with speed control trigger with locking function and thumbwheel for stroke preselection

**Selectable 3-level pendulum stroke**  
for optimum sawing performance in any material

**Metabo VibraTech (MVT):**  
integrated weight balance to reduce vibrations

SSEP 1400 MVT



Sabre saws can, thanks to the universal range of sabre saw blades, be used in different materials, such as here in aerated concrete.



Using the **SSEP 1400 MVT** from Metabo, building and renovation trade professionals' progress quickly, even in the most demanding applications, thanks to the powerful 1,400 Watt.



The **SSE 1100** is suited for all standard applications, for example for shortening pipes, for cutting wood and insulation boards and much more.

10.8 V  
18 V



Technical data	Cordless Sabre Saw PowerMaxx ASE	Cordless Sabre Saw SSE 18 LTX Compact	Cordless Sabre Saw ASE 18 LTX
Type of battery pack	Li-Ion	Li-Ion / LiHD	Li-Ion / LiHD
Battery pack voltage	10.8 V	18 V	18 V
Strokes in idle	0 - 3,100 /min	0 - 3,100 /min	0 - 2,700 /min
Saw blade stroke	13 mm	13 mm	30 mm
Weight (including battery pack)	1.2 kg	1.9 kg	3.9 kg

Scope of delivery

Order no.	602264	602266	602269
Jigsaw blade for metal	■	■	
Sabre saw blade for wood and metal	■	■	
Hexagonal wrench			■
2 Li-Power battery packs (10.8 V/2.0 Ah)	■		
2 LiHD battery packs (18 V/4.0 Ah)		■	
2 LiHD battery packs (18 V/5.5 Ah)			■
Charger ASC 30-36 V »AIR COOLED«		■	■
Charger LC 40	■		
Plastic carry case	■	■	■

Equipment variants can be found in the Metabo price list and on the internet

Product advantages

- Light, extremely handy saw for one or two handed operation
- Especially suitable for working in difficult to reach places
- Extended range of application thanks to unique Quick retainer for sabre saw blades and jigsaw blades
- Depth guide can be adjusted without tools for ideal utilisation of the saw blade and diverse applications such as plunge cuts
- Integrated LED work light for optimum illumination of the cutting line
- Practical capacity display for checking the charge status
- Slim, lightweight machine with soft-grip handle for comfortable sawing in every working position
- Robust die-cast aluminium gear housing, coated for optimum handling
- Saw blade rotatable by 180° for working comfortably overhead
- Depth guide can be adjusted for ideal utilisation of the saw blade and diverse applications such as plunge cuts
- Battery packs with capacity display for checking the charge status
- Variospeed (V) Electronics for working with customised stroke rates for the materials used
- Metabo Quick for changing saw blades without tools
- Wide range of uses thanks to the adapted Metabo saw blade range

System components

Accessories → 406 | Battery packs → 72



Technical data	Sabre Saw SSE 1100	Sabre Saw SSE 1400 MVT
Rated input power	1,100 W	1,400 W
Output power	550 W	600 W
Strokes in idle	0 - 2,600 /min	0 - 2,800 /min
Saw blade stroke	28 mm	32 mm
Pendulum stroke levels	0	3
Weight (without mains cable)	3.9 kg	4.6 kg
Cable length	4 m	4 m

Scope of delivery

Order no.	606177	606178
Saw blade wood		■
Saw blade metal		■
Saw blade wood + metal	■	
Plastic carry case	■	■

Product advantages

- Slim machine with soft-grip handle for comfortable sawing in every working position
- Variospeed (V) Electronics for working with customised stroke rates for the materials used
- Continuous mode control trigger c/w locking function for continuous operation
- Quick sawing progress thanks to powerful motor
- Powerful 1,400 Watt motor with constant stroke rate for very demanding applications
- Selectable 3-level pendulum stroke for optimum sawing performance in any material
- Metabo VibraTech (MVT): integrated weight balance to reduce vibrations
- Vario-Tacho-Constamatic (VTC)-Full Wave Electronics for work with materials requiring customised stroke rates, which remain almost constant under load
- Maximum control with speed control trigger c/w locking function and thumbwheel for stroke preselection
- Integrated LED work light for optimum illumination of the cutting line
- Robust aluminium die-cast gear housing, coated for optimum handling
- Metabo Quick for changing saw blades without tools
- Saw blade rotatable by 180° for working comfortably overhead
- Depth guide can be adjusted without tools for ideal utilisation of the saw blade and diverse applications such as plunge cuts
- Gear protected against dust and water splashes
- Wide range of uses thanks to the adapted Metabo saw blade range

System components

Accessories → 406

01  
02  
03  
04  
05  
06  
07  
08  
09  
10  
11  
12  
13  
14  
15

Metal

Order no. (corresponds to Bosch type)		631129000 (S 918 AF)	631130000 (S 918 BF)	631454000 (S 922 EF)	631493000 (S 1122 EF)	631990000 (S 422 BF)	631491000 (S 922 BF)	631494000 (S 1122 BF)	628260000 (S 925 VF)	631991000 (S 1025 VF)	628261000 (S 1125 VF)	628263000 (S 1125 VF)	631909000 (S 1025 BF)	631992000 (S 920 CF)	631993000 (S 1120 CF)	628255000 (S 926 BEF)	628256000 (S 1126 BEF)	628257000 (S 926 CHF)	631989000 (T 1126 CHF)	628258000 (S 1136 BEF)	628269000 (S 1136 CHF)	631914000 (S 123 XF)	
Material to be processed/ or applications		»flexible« sabre saw blades < 1.0 mm			»professional« sabre saw blades >1.0 mm blade thickness								»premium«										
Sheet metal		< 3.0 mm																					
Pipes, profiles		< 100 mm																					
Demolition and reconstruction work		-																					

Wood

Order no. (corresponds to Bosch type)		628241000 (S 617 K)	628242000 (S 1617 K)	628244000 (S 1111 K)	631470000 (S 644 D)	631472000 (S 1344 D)	631488000 (S 1631 L)	631913000 (S 2345 X)
Material to be processed/ or applications		For curved cuts, fast, coarse	Extra long, fast, coarse	Fast, coarse	For plunge cuts	Extra long		Universally progressively toothed
Wood (dry), chipboard, plywood		< 100 mm						
Wood (damp), firewood, removal of branches		< 100 mm						
Plastics		< 100 mm						

Wood + Metal

Order no. (corresponds to Bosch type)		631125000 (S 1211 H)	631492000 (S 922 VF)	631495000 (S 1122 VF)	631407000 (S 1222 VF)	631932000 (S 1022 HF)	631984000 (S 611 VF)	631985000 (S 711 VF)	631986000 (S 1111 VF)	631987000 (S 1411 VF)	631925000 (S 610 DF)	631926000 (S 1110 DF)	631915000 (S 3456 XF)
Material to be processed/ or applications		»flexible« < 1.0 mm				»professional« >1.0 mm							
Wood, chipboards		Extra long	Short		Extra long	Especially for pallet repairs		For curved cuts		Extra long	Extra thick, robust, short	Extra thick, robust, long	Universally progressively toothed
Wood with nails/metal inserts		< 100 mm											
Sheet metal		< 3.0 mm											
Pipes/profiles		< 100 mm											
Plastics/window frames		< 100 mm											
Pallet repairs		-											
Demolition and reconstruction work		-											

Special Applications

Order no. (corresponds to Bosch type)		631817000 (S 518 EHM)	631818000 (S 1130 Riff)	631137000 (S 641 HM)	631146000 (S 1241 HM)	631819000 (S 2041 HM)	631144000 (S 713 AW)	631907000 (S 628 DF)	631916000 (S 1543 HM)	631917000 (S 1234 HM)	631918000 (S 2243 HM)
Material to be processed/ or applications				Short	Long	Extra long		Clean cuts			
Stainless steel sheet (Inox)		2-4 mm									
Plastics, glass-fibre reinforced plastics		-									
Cardboard, polystyrene, insulation materials		-									
Gypsum Plaster		-									
Cast-iron pipes		< Ø 6"									
Brickwork		< 100 mm									
Aerated concrete blocks, fibre-reinforced cement		< 100 mm									
Masonry, brickwork, porous concrete, sand-lime brick, cement board		< 150 mm									

**Legend**

Progressively toothed = Tooth pitch ascending suitable for both thin and thick materials

■ highly suitable  
□ Only suitable under certain circumstances

01  
02  
03  
04  
05  
06  
07  
08  
09  
10  
11  
12  
13  
14  
15

# Sabre Saw Blades

## Features of the Metabo sabre saw blades

### Colour

The colour indicates for which material the saw blade is best suited.

- Yellow** for wood
- Yellow with blue lettering** For wood/metal
- Blue** For metal
- Blue with red** For metal
- Black** For special applications

### Basic blade material

- HCS** Carbon steel, for cutting soft wood, hardboards, plastics
- HSS** High yielding high-speed steel, suitable for metal, aluminium work
- BiM** Bi-metal: particularly flexible mix of HCS and HSS. The saw blades have a much higher life expectancy than HCS and HSS and have proven their worth when there is risk of the shaft breaking
- HM** Carbide: these particularly high performing saw blades are suitable for stainless steels, fibreglass reinforced plastic, gypsum plaster or cement fibre boards. Saw blades with a carbide coating are suitable to cut ceramic tiles

### Quality classes

- »classic« series Good work results with very good tool life
- »flexible« series Unbreakable, flexible
- »professional« series Stable, precise working, for tough applications
- »professional premium« series Extremely long service life
- »pionier« series Fast through all materials
- »expert« series For special applications

### Version



**Teeth milled, offset for clearance gap**  
A relatively rough cut, fast progress in cutting on hard and soft wood, aluminium, non-ferrous metals and plastics



**Teeth milled, waved for clearance gap**  
A fine cut with straight tool guidance in hard and soft wood, aluminium, non-ferrous metals and plastics

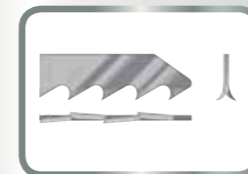

**Teeth ground, offset for clearance gap**  
Fast cutting in hard and soft woods



**Teeth ground, offset for clearance angle and clearance gap**  
Fine and clean cut in wood and plastics

### Shaft form

The sabre saw blades from Metabo are produced with a universal shank shape matching the sabre saws of standard brand names.



# Sabre Saw Blades with 1/2" Universal Shank

■ Suitable for Metabo, AEG, Black & Decker, Bosch, DeWalt, Flex, Hitachi, Milwaukee, Porter Cable, Skil ...

## for metal, »flexible« series

Break-proof, flexible, sabre saw blades < 1.0 mm thick





Version	Material finish	Overall length mm	Thickness mm	Tooth pitch	Corresponds to Bosch type	Sales unit	Order no.
Sheets 1-3 mm, profiles 5-100 mm							
Wavy, milled	BiM	150	0.9	1 mm/ 24 TPI	S 918 AF	2	631129000*
Sheets 2-8 mm, profiles 10-100 mm							
Wavy, milled	BiM	150	0.9	1.8 mm/ 14 TPI	S 918 BF	2	631130000*
Sheets 0.7-3 mm, profiles Ø 0.5-100 mm, profiles 0.5-100 mm							
Offset, milled	BiM	150	0.9	1.4 mm/ 18 TPI	S 922 EF	2	631080000*
						5	631454000*
						25	628251000*
Sheets 1.5-4 mm, profiles Ø 5-175 mm, profiles 5-175 mm for flush cuts							
Offset, milled	BiM	225	0.9	1.4 mm/ 18 TPI	S 1122 EF	2	631095000*
						5	631493000*
						25	628252000*
Sheets 1.5-6 mm, especially for curved cuts							
Offset, milled	BiM	100	0.9	1.8 mm/ 14 TPI	S 422 BF	5	631990000*
Sheets 3-8 mm, pipes, profiles Ø 10-100 mm							
Offset, milled	BiM	150	0.9	1.8 mm/ 14 TPI	S 922 BF	2	631093000*
						5	631491000*
						25	628253000*
						100	625491000
Sheets 3-8 mm, pipes, profiles Ø 10-175 mm, flush cuts							
Offset, milled	BiM	225	0.9	1.8 mm/ 14 TPI	S 1122 BF	2	631096000*
						5	631494000*
						25	628254000*
						100	625492000
Sheets 3-8 mm, profiles							
Offset, milled	BiM	100	0.9	2 mm/ 14 TPI	S 522 BF	5	628267000*
Sheets 0.7-3 mm, profiles							
Offset, milled	BiM	100	0.9	1.41 mm/ 18 TPI	S 522 EF	5	628268000*

## for metal, »professional« series

Stable, precise, for tough applications, sabre saw blades >1.0 mm thick

Version	Material finish	Overall length mm	Thickness mm	Tooth pitch	Corresponds to Bosch type	Sales unit	Order no.
Sheets 2-12 mm, pipes, profiles Ø 10-100 mm							
Offset, milled	BiM	150	1.25	1.8-2.6 mm/ 10-14 TPI	S 925 VF	5	628260000*

\*Self-service packaging

Version	Material finish	Overall length mm	Thickness mm	Tooth pitch	Corresponds to Bosch type	Sales unit	Order no.
	Sheets 2-12 mm, pipes, profiles Ø 10-150 mm						
Offset, milled	BiM	200	1.25	1.8-2.6 mm/ 10-14 TPI	S 1025 VF	5	631991000*
	Sheets 2-12 mm, pipes, profiles Ø 10-175 mm						
Offset, milled	BiM	225	1.25	1.8-2.6 mm/ 10-14 TPI	S 1125 VF	5	628261000*
						25	628262000*
	Sheets 2-12 mm, pipes, profiles Ø 10-250 mm						
Offset, milled	BiM	300	1.25	1.8-2.6 mm/ 10-14 TPI	S 1225 VF	5	628263000*
	Sheets 2-8 mm, pipes, profiles Ø 10-150 mm						
Offset, milled	BiM	200	1.25	1.8 mm/ 14 TPI	S 1025 BF	5	631909000*
	Sheets 4-10 mm, pipes, profiles Ø 20-100 mm, for pipe cutting equipment, for breaking and renovation work, glass						
Offset, milled	BiM	150	1.6	2.5+ 3.2 mm/ 8+10 TPI	S 920 CF	5	631992000*
	Sheets 4-10 mm, pipes, profiles Ø 20-175 mm, for pipe cutting equipment, for breaking and renovation work, glass						
Offset, milled	BiM	225	1.6	2.5+ 3.2 mm/ 8+10 TPI	S 1120 CF	5	631993000*
	Sheets 3-8 mm, pipes, profiles Ø 20-100 mm, for pipe cutting equipment, for breaking and renovation work for straight, precise and particularly clean cuts						
Offset, milled	BiM	150	1.1	1.4+ 1.8 mm/ 14+18 TPI	S 926 BEF	5	628255000*
	Sheets 3-8 mm, pipes, profiles Ø 20-175 mm, for pipe cutting equipment, for breaking and renovation work for straight, precise and particularly clean cuts						
Offset, milled	BiM	225	1.1	1.4+ 1.8 mm/ 14+18 TPI	S 1126 BEF	5	628256000*
	Sheets 4-10 mm, pipes, profiles Ø 20-100 mm, for pipe cutting equipment, for breaking and renovation work for straight, precise and quick cuts						
Offset, milled	BiM	150	1.1	2.5+ 3.2 mm/ 8+10 TPI	S 926 CHF	5	628257000*
	Sheets 4-10 mm, pipes, profiles Ø 20-175 mm, for pipe cutting equipment, for breaking and renovation work for straight, precise and quick cuts						
Offset, milled	BiM	225	1.1	2.5+ 3.2 mm/ 8+10 TPI	S 1126 CHF	5	631989000*

**for metal, »professional premium« series**

Unique, very aggressive and robust gearing, high cutting speeds and highest durability

Version	Material finish	Overall length mm	Thickness mm	Tooth pitch	Corresponds to Bosch type	Sales unit	Order no.
	Sheets 3-8 mm, pipes, profiles Ø 20-175 mm, for pipe cutting equipment, for straight, precise and particularly clean cuts with an extremely long service life						
Offset, milled	BiM	225	0.9	1.4+1.8 mm/ 14+18 TPI	S 1136 BEF	2	628258000*

Version	Material finish	Overall length mm	Thickness mm	Tooth pitch	Corresponds to Bosch type	Sales unit	Order no.
	Sheets 4-10 mm, pipes, profiles Ø 20-175 mm, for pipe cutting equipment, for straight, precise and quick cuts with an extremely long service life						
Offset, milled	BiM	225	1.1	2.5+3.2 mm / 8+10 TPI	S 1136 CHF	2	628269000*





**for metal, »pionier« series**

Universal and quick in both thick and thin material



Version	Material finish	Overall length mm	Thickness mm	Tooth pitch	Corresponds to Bosch type	Sales unit	Order no.
	Sheets 1-8 mm, profiles Ø 5-100 mm						
Offset, milled	BiM	150	0.9	Progressive	S 123 XF	2	631911000*
	Sheets 1-8 mm, profiles Ø 5-100 mm						
Ground, milled	BiM	150	0.9	Progressive	S 123 XF	5	631914000*

**for wood and metal, »flexible« series**

Unbreakable, flexible, sabre saw blades < 1.0 mm thick

Version	Material finish	Overall length mm	Thickness mm	Tooth pitch	Corresponds to Bosch type	Sales unit	Order no.
	Wood, wood with nails, non-ferrous metals, plastics						
Offset, milled	HCS	300	0.9	2.5 mm/ 10 TPI	S 1211 H	2	631125000*
	Wood, wood with nails, metal inserts Ø 5-100 mm, sheets, pipes, profiles 3-10 mm, plastics 3-100 mm						
Offset, milled	BiM	150	0.9	1.8-2.6 mm/ 10-14 TPI	S 922 VF	2	631094000*
						5	631492000*
						25	628246000*
	Wood, wood with nails, metal inserts Ø 5-175 mm, sheets, pipes, profiles 3-10 mm, plastics 3-175 mm						
Offset, milled	BiM	225	0.9	1.8-2.6 mm/ 10-14 TPI	S 1122 VF	2	631097000*
						5	631495000*
						25	628247000*
						100	625494000
	Wood, wood with nails, metal inserts Ø 5-250 mm, sheets, pipes, profiles 3-10 mm, plastics 3-250 mm						
Offset, milled	BiM	300	0.9	1.8-2.6 mm/ 10-14 TPI	S 1222 VF	2	631098000*
						5	631407000*
						25	628248000*
	Wood, wood with nails, metal inserts Ø 5-150 mm, pallets, sheets, pipes, profiles 3-12 mm, plastics 3-150 mm						
Offset, milled	BiM	200	0.9	2.5 mm/ 10 TPI	S 1022 HF	5	631932000*
						25	628249000*
						200	625497000

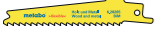
\*Self-service packaging

Version	Material finish	Overall length mm	Thickness mm	Tooth pitch	Corresponds to Bosch type	Sales unit	Order no.
 Wood, wood with nails, wood, plastics, plywood							
Offset, milled	BiM	100	0.9	4 mm/6 TPI	S 511 DF	5	628265000*
 wood, metal, plastics							
Offset, milled	BiM	100	0.9	1,41-1.81 mm/ 14-18 TPI	S 522BEF	5	628266000*

**for wood and metal, »professional« series**

Fast, stable, for tough applications, sabre saw blades >1.0 mm thick

Version	Material finish	Overall length mm	Thickness mm	Tooth pitch	Corresponds to Bosch type	Sales unit	Order no.
 Wood 10-100 mm, wood with nails, plastics, window frames, specially designed for plunge cuts							
Offset, milled	BiM	150	1.25	3.2-5.1 mm/ 5-8 TPI	S 611VF	5	631984000*
						25	628250000*
 Wood, wood with nails, plastics, plywood 10-100 mm, specially designed for curved cuts							
Offset, milled	BiM	150	1.25	3.2-5.1 mm/ 5-8 TPI	S 711 VF	5	631985000*
 Wood, wood with nails, plastics, plywood 10-175 mm							
Offset, milled	BiM	225	1.25	3.2-5.1 mm/ 5-8 TPI	S 1111 VF	5	631986000*
 Wood, wood with nails, plastics, plywood 10-250 mm							
Offset, milled	BiM	300	1.25	3.2-5.1 mm/ 5-8 TPI	S 1411 VF	5	631987000*
 Wood, wood with nails, metal inserts Ø 10-100 mm, plastics, for breaking and renovation work							
Offset, milled	BiM	150	1.6	4.3 mm/ 6 TPI	S 610 DF	5	631925000*
 Wood, wood with nails, metal inserts Ø 10-175 mm, plastics, for breaking and renovation work							
Offset, milled	BiM	225	1.6	4.3 mm/ 6 TPI	S 1110 DF	5	631926000*



**for wood and metal, »pionier« series**

Universal and quick in all materials

Version	Material finish	Overall length mm	Thickness mm	Tooth pitch	Corresponds to Bosch type	Sales unit	Order no.
 Wood, wood with nails, metal inserts Ø 5-150 mm, sheets, pipes, profiles 3-18 mm, plastics 5-150 mm							
Offset, milled	BiM	200	1.25	Progressive	S 3456 XF	2	631912000*
						5	631915000*





**for wood, »classic« series**

For tough applications on the construction site and in the garden

Version	Material finish	Overall length mm	Thickness mm	Tooth pitch	Corresponds to Bosch type	Sales unit	Order no.
 Wood (also when damp) 6-100 mm, removal of branches, for fast, rough cuts, specially designed for curved cuts							
Offset, milled	HCS	150	1.25	8.5 mm/ 3 TPI	S 617 K	2	628240000*
						5	628241000*
 Wood (also when damp) 10-250 mm, removal of branches, for fast, rough cuts							
Offset, milled	HCS	300	1.25	8.5 mm/ 3 TPI	S 1617 K	5	628242000*
 Wood (also when damp) 15-190 mm, firewood, for fast, rough cuts							
Offset, milled	HCS	225	1.25	8.5 mm/ 3 TPI	S 1111 K	2	628243000*
						5	628244000*

**for wood, »professional« series**

For professional applications on the construction site and in the garden

Version	Material finish	Overall length mm	Thickness mm	Tooth pitch	Corresponds to Bosch type	Sales unit	Order no.
 Wood 6-100 mm, chipboard 6-60 mm, plywood, plastics, specially designed for plunge cuts							
Side set, ground	HCS	150	1.25	4.0 mm/ 6 TPI	S 644 D	2	631120000*
						5	631470000*
 Wood 10-250 mm, chipboard 10-100 mm, plywood, plastics							
Side set, ground	HCS	300	1.25	4.0 mm/ 6 TPI	S 1344 D	2	631122000*
						5	631472000*
 Wood (also damp) 15-190 mm, firewood, removal of branches							
side set, ground, carbide-coated	HCS	240	1.5	5.0 mm/ 5 TPI	S 1531 L	2	631139000*
						5	631488000*
						25	628245000*
 Wood (also moist) 15-100 mm, firewood 15-90 mm							
side set, ground, carbide-coated	HCS	240	1.5	8.5 mm/ 3 TPI	S 1542 K	5	631490000*

**for wood »pionier« series**

Universal and quick in both thick and thin material

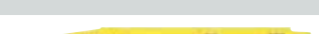









Version	Material finish	Overall length mm	Thickness mm	Tooth pitch	Corresponds to Bosch type	Sales unit	Order no.
 Wood (also damp) 6-100 mm, chipboard 6-60 mm, plywood, plastics, specially designed for plunge cuts							
Side set, ground	HCS	200	1.25	Progressive	S 2345 X	2	631910000*
						5	631913000*

\*Self-service packaging



for special applications, »expert« series

The optimum sabre saw blade for all special applications

Version	Material finish	Overall length mm	Thickness mm	Tooth pitch	Corresponds to Bosch type	Sales unit	Order no.
	Stainless steel sheets (Inox) 2-4 mm, stainless steel profiles 2-50 mm, plastic (glass fibre reinforced plastic)						
HM strip, ground	HM	115	1.25	1.4 mm/ 18 TPI	S 522 EHM	2	631817000*
	Cast steel pipe Ø max. 6", stone, plastic (glass fibre reinforced plastic)						
Carbide coated, grit 30	HM	225	1.25		S 1130 Riff	2	631818000*
	Cardboard, polystyrene, insulation materials						
Knife-blade ground	HCS	150	1		S 713 AW	2	631144000*
	Aerated concrete 6-100 mm, stone 6-100 mm, fibre cement, glass fibre reinforced plastic						
HM-tipped, side-set	HM	150	1.25	4.3 mm/ 6 TPI	S 641 HM	1	631137000*
	Porous concrete, brickwork 10-250 mm, fibre cement, glass fibre reinforced plastic						
HM-tipped, side-set	HM	300	1.5	8.5 mm/ 3 TPI	S 1241 HM	1	631146000*
	Porous concrete, brickwork 20-350 mm, fibre cement, glass fibre reinforced plastic						
HM-tipped, side-set	HM	400	1.5	12.7 mm/ 2 TPI	S 2041 HM	1	631819000*
	Gypsum plaster, for clean cuts						
Offset, milled	BiM	100	0.9	4.2 mm/ 6 TPI	S 528 DF	5	628264000*
	Gypsum plaster 8-100 mm, for clean cuts						
Offset, milled	BiM	150	1.25	4.3 mm/ 6 TPI	S 628 DF	5	631907000*
							
	HM	240	1.5	12.7 mm/ 2 TPI	S 1543 HM	1	631916000*
							
	HM	305	1.5	12.7 mm/ 2 TPI	S 1243 HM	1	631917000*
							
	HM	455	1.5	12.7 mm/ 2 TPI	S 2243 HM	1	631918000*

\*Self-service packaging

# 18 V



### Technical data

Type of battery pack	Li-Ion / LiHD
Battery pack voltage	18 V
Orbital frequency with no load	7,000 - 18,000 /min
Bit retainer	Compatible with OIS and Starlock
Oscillation angle left/right	1.6 °
Base plate, measurement from corner to corner	93 mm
Weight (including battery pack)	1.9 kg

### Scope of delivery

Order no.	613021
Plunge saw blade 32 mm HCS (wood)	■
Segment saw blade 85 mm BiM (wood + metal)	■
Scraping knife, rigid 52 mm HCS	■
Triangular hook and loop sanding plate 93 mm	■
5 Hook and loop sanding sheets 93 mm P 80	■
5 Hook and loop sanding sheets 93 mm P 120	■
Suction adapter	■
Multi-adapter	■
2 LiHD battery packs (18 V/4.0 Ah)	■
Charger ASC 30-36 V »AIR COOLED«	■
Plastic carry case	■

Equipment variants can be found in the Metabo price list and on the internet

### Product advantages

- Oscillating cordless multi-tool with high performance comparable to that of a mains powered version
- Indispensable for interior development such as cutting, sanding, scraping and grating of different materials
- Tool holder for maximum compatibility to OIS, Starlock and other accessories
- Metabo Quick tool change system for time-saving, convenient change of accessories
- Fast and powerful thanks to the combination of a large oscillation angle of 3.2° and VTC-Electronics to maintain constant speed even under load
- Extra bright double LED lights for good visibility of the working area
- Slim design and non-slip soft-grip surface for optimised handling
- Extraction possibility by means of connecting an all-purpose vacuum cleaner
- Battery packs with capacity display for checking the charge status

### System components

Accessories → 416 | Battery packs → 72



### Technical data

Orbital frequency with no load	11,000 - 18,500 /min
Rated input power	400 W
Bit retainer	Compatible with OIS and Starlock
Oscillation angle left/right	1.6 °
Base plate, measurement from corner to corner	93 mm
Weight (without mains cable)	1.4 kg

### Scope of delivery

Order no.	601406
Plunge saw blade 32 mm HCS (wood)	■
Segment saw blade 85 mm BiM (wood + metal)	■
Scraping knife, rigid 52 mm HCS	■
Plunge saw blade 32 mm BiM (metal)	■
Segment saw blade 85 mm carbide (tiles)	■
Triangular sanding plate 78 mm carbide (tiles)	■
Triangular hook and loop sanding plate 93 mm	■
5 Hook and loop sanding sheets 93 mm P 80	■
5 Hook and loop sanding sheets 93 mm P 120	■
Suction adapter	■
Multi-adapter	■
Tool box	■
MetaLoc case	■

Equipment variants can be found in the Metabo price list and on the internet

### Product advantages

- Indispensable for interior development such as cutting, sanding, scraping and grating of different materials
- Tool holder for maximum compatibility to OIS, Starlock and other accessories
- Metabo Quick tool change system for time-saving, convenient change of accessories
- Fast and powerful thanks to the combination of a large oscillation angle of 3.2° and VTC-Electronics to maintain constant speed even under load
- Extra bright double LED lights for good visibility of the working area
- Slim design and non-slip soft-grip surface for optimised handling
- Extraction possibility by means of connecting an all-purpose vacuum cleaner

Extraction systems → 453

Saw blades for wood

- Clean plunge cuts in wood
- Convex row of teeth for easy starting and clean cutting results
- Plunge saw blade with lasered depth scale for precise immersion depths



	Holder	Material	Length mm	Width mm	Tooth pitch	Sales unit	Order no.
Soft wood	Starlock	HCS	45	32	1.3 mm/20 TPI	1	626950000*
						5	626951000*
Coated boards, laminated flooring, for clean cuts	Starlock	HCS	45	32	1.8 mm/14 TPI	1	626956000*

Saw blades for wood and metal

- High-quality Bi-metal gearing for long service life and high cutting quality
- Plunge saw blade with lasered depth scale for precise immersion depths



	Holder	Material	Length mm	Width mm	Diameter mm	Tooth pitch	Sales unit	Order no.
Soft wood, hard wood, wood with nails, coated boards, plastic	Starlock	BiM	30	20	-	1.3 mm/20 TPI	1	626952000*
Soft wood, hard wood, wood with nails, coated boards, plastic	Starlock	BiM	45	32	-	1.3 mm/20 TPI	1	626953000*
							5	626954000*
Soft wood, hard wood, wood with nails, coated boards, plastic	Starlock	BiM	35	65	-	1.3 mm/20 TPI	1	626955000*
Soft wood, hard wood, wood with nails, coated boards, plastic, profiles	Starlock	BiM	-	-	85	1.3 mm/20 TPI	1	626960000*

Saw blades for metal

- High-quality gearing for long service life and high cutting quality
- Plunge saw blade with lasered depth scale for precise immersion depths



	Holder	Material	Length mm	Width mm	Tooth pitch	Sales unit	Order no.
Copper profiles, aluminium profiles, NF metals coated materials, nails	Starlock	BiM	45	32	1.3 mm/20 TPI	1	626957000*
						5	626958000*

	Holder	Material	Length mm	Width mm	Tooth pitch	Sales unit	Order no.
Metal, stainless steel, hardened screws and nails	Starlock	HM	35	32	1.3 mm/20 TPI	1	626959000*

Scraper

- Durable HCS blade for universal use



	Holder	Material	Length mm	Width mm	Sales unit	Order no.
Tile adhesive, carpets, carpet adhesive	Starlock		25	52	1	626961000*

Base plates

- High-quality carbide coating for high material removal and long service life



	Holder	Material	Diameter mm	Tooth pitch	Sales unit	Order no.
Remove tile grooves, putty, tile adhesive, carpet adhesive	Starlock	Carbide, coated	85	Riff 30	1	626962000*
Putty, tile adhesive, carpet adhesive, mortar, rough wood removal	Starlock	Carbide, coated	78	Riff 30	1	626963000*

Assortments for multi-tools

	Order no.
<p><b>Tiler's set</b></p> <ul style="list-style-type: none"> <li>■ Tiler's set for varied renovation and conversion applications, such as removal of mortar or tile adhesive, removal of grout in wall and floor tiles, cutting of smaller cut-outs in soft wall tiles</li> <li>■ Set comprising: 1 x carbide segment saw blade 85 mm (tiles), 1 x carbide triangular sanding pad 78 mm (tiles), 1 x scraper rigid 52 mm HCS, 1 x plunge saw blade 32 mm BiM (metal)</li> <li>■ OIS holder</li> </ul>	626419000*
<p><b>Interior finishing set</b></p> <ul style="list-style-type: none"> <li>■ Interior finishing set for varied floor and installation applications, such as cutting of laminate/parquet, shortening door frames at floor level, plunge cuts in coated boards, wood, cutting of apertures in furniture elements</li> <li>■ Set comprising: 1 x plunge saw blade 32 mm HCS (wood), 1 x segment saw blade 85 mm BiM (wood + metal), 1 x scraper rigid 52 mm HCS, 1 x plunge saw blade 32 mm BiM (metal)</li> <li>■ OIS holder</li> </ul>	626420000*

\*Self-service packaging

Hook and loop sanding sheets for wood and metal, »professional« series



- High-quality sanding paper with semi-open coarseness and high removal of material for a homogenous finish
- For veneers, solid wood, polyester, steel and stainless steel sheets, non-ferrous metals, light alloys
- For sanding veneered cabinet fronts and sides, sanding furniture covered with veneers with hot-melt type adhesive edges, decorative sanding of stainless steel sheets, sanding-based repair work, and deburring cut sheet metal

Dimensions mm	Grit	Sales unit	Order no.
93 x 93	P 40	5	624940000*
93 x 93	P 60	5	624941000*
93 x 93	P 80	5	624942000*
93 x 93	P 100	5	624943000*
93 x 93	P 120	5	624944000*
93 x 93	P 180	5	624945000*
93 x 93	P 240	5	624946000*
93 x 93	P 320	5	624947000*
93 x 93	P 40	25	624980000
93 x 93	P 60	25	624981000
93 x 93	P 80	25	624982000
93 x 93	P 100	25	624983000
93 x 93	P 120	25	624984000
93 x 93	P 180	25	624985000
93 x 93	P 240	25	624986000
93 x 93	P 320	25	624987000
Assortment (10 x P 60, 10 x P 80, 5 x P 120)		25	624988000

Hook and loop sanding sheets for paints and lacquers, »professional« series



- High-quality sanding paper with semi-open coarseness and high removal of material
- Suitable for working with paints and lacquers of all types and filler compounds
- For deburring, cleaning veneers, solid woods, plywood, and lacquers, deburring furniture veneer

Dimensions mm	Grit	Sales unit	Order no.
93 x 93	P 40	25	625681000
93 x 93	P 60	25	625682000
93 x 93	P 80	25	625683000
93 x 93	P 100	25	625684000
93 x 93	P 120	25	625685000
93 x 93	P 180	25	625686000
93 x 93	P 240	25	625687000
93 x 93	P 320	25	625688000

Hook and loop abrasive nylon web, corundum abrasive



- Used for structuring wood (applying a rustic appearance), for removing rust from metal and for sanding paints (tarnishing)

Grit	Order no.
P 100	624958000*
P 280	624959000*

Additional accessories for multi-tools



- Triangular sanding plate**
- Perforated hook and loop sanding pad
  - Quick, easy change of the sanding sheets
  - For multi-tool .Dimension from corner to corner: 93 mm
  - OIS compatible



















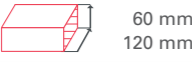
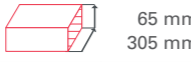
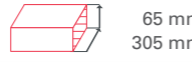
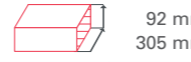
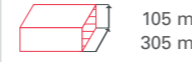

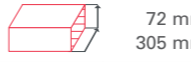
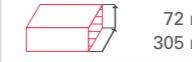
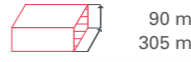
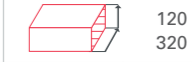

Order no.  
626421000\*

\*Self-service packaging

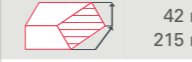

# Semi-stationary Woodworking

# Which mitre saw for which application?











Comparative technical values	 KS 216 M Lasercut / KS 18 LTX 216	 KGS 216 M / KGS 18 LTX 216	 KGSV 216 M	 KGS 254 M	 KGS 305 M	 KS 305 M	 KGSV 72 Xact	 KGSV 72 Xact SYM	 KGS 254 Plus	 KGS 315 Plus	 KGS 254 I Plus
Maximum cross section of the workpieces at 90°/90°	 60 mm 120 mm	 65 mm 305 mm	 65 mm 305 mm	 92 mm 305 mm	 105 mm 305 mm	 80/102 mm <sup>1)</sup> 200/150 mm <sup>1)</sup>	 72 mm 305 mm	 72 mm 305 mm	 90 mm 305 mm	 120 mm 320 mm	 90 mm 305 mm
Maximum cross section of the workpieces at 45°/45°	 45 mm 80 mm	 36 mm 205 mm	 36 mm 205 mm	 47 mm 205 mm	 67 mm 205 mm	 45 mm 130 mm	 42 mm 215 mm	 42 mm 215 mm	 54 mm 214 mm	 76 mm 223 mm	 54 mm 214 mm
Support surface L x W	725 x 155 mm	730 x 345 mm	730 x 345 mm	775 x 340 mm	775 x 340 mm	775 x 340 mm	830 x 365 mm	830 x 365 mm	1,000 x 365 mm	1,070 x 365 mm	1,000 x 365 mm
Saw blade/number of teeth*	Ø 216 mm/40	Ø 216 mm/40	Ø 216 mm/60	Ø 254 mm/48	Ø 305 mm/56	Ø 305 mm/56	Ø 216 mm/48	Ø 216 mm/60	Ø 254 mm/60	Ø 315 mm/84	Ø 254 mm/60
Adjustment parameters: ■ Turntable left/right (maximum) ■ Bevel left/right (maximum)	47°/47° 47°/0°	47°/47° 47°/0°	47°/47° 47°/0°	47°/47° 47°/0°	47°/47° 47°/0°	52°/52° 47°/2°	50°/50° 47°/47°	50°/50° 47°/47°	47°/60° 46°/46°	47°/60° 46°/46°	47°/60° 46°/22,5°
Rated input power (S6 20%)	1,350 W / 18 V	1,500 W / 18 V	1,700 W	1,800 W	2,000 W	2,000 W	1,800 W	1,800 W	2,000 W	2,200 W	1,800 W
Weight	9.4 kg / 9.6 kg	13.5 kg / 13.8 kg	13.5 kg	16.3 kg	19.6 kg	17 kg	16.1 kg	18.3 kg	24 kg	26 kg	32.5 kg

\* Number of teeth of the standard saw blade

<sup>1)</sup> with additional stop (d x w) 100 x 150 mm

Application	KS 216 M Lasercut / KS 18 LTX 216	KGS 216 M / KGS 18 LTX 216	KGSV 216 M	KGS 254 M	KGS 305 M	KS 305 M	KGSV 72 Xact	KGSV 72 Xact SYM	KGS 254 Plus	KGS 315 Plus	KGS 254 I Plus
Cutting work onsite	■■■	■■■	■■■	■■■	■■■	■■■	■■■	■■■	■■	■■	■
Preparation work in the workshop	■	■■	■■	■■	■■■	■■■	■■■	■■■	■■■	■■■	■■■
Clean sawing in enclosed areas	■■	■■	■■	■■	■■	■■	■■■	■■■	■■■	■■■	■■■
Cutting of aluminium profiles			■■				■■**	■■	■■**	■■**	
Quiet sawing											■■■
Trench cuts		■■■	■■■	■■■	■■■		■■■	■■■	■■■	■■■	■■■
Sawing skirtings	■■					■		■■■			

\*\* with saw blade »multi cut« (accessory)

Equipment	KS 216 M Lasercut / KS 18 LTX 216	KGS 216 M / KGS 18 LTX 216	KGSV 216 M	KGS 254 M	KGS 305 M	KS 305 M	KGSV 72 Xact	KGSV 72 Xact SYM	KGS 254 Plus	KGS 315 Plus	KGS 254 I Plus
Saw blade inclination	left	left	left	left	left	left	left/right	left/right	left/right	left/right	left/right
Dust extraction properties	standard	Effective	Effective	Effective	Effective	Effective	Effective	Effective	Effective	Optimum (2 point)	Optimum (2 point)
Sliding function and cutting depth limiter (e.g. for rebating)		●	●	●	●		●	●	●	●	●
Laser - mains powered											
Work light – mains powered	●	●	●	●	●	●	●	●	●	●	●
»Quick« saw blade change - no tools required									●	●	●
Soft start			●		●	●	●	●	●	●	●
Variable speed			●				●	●	●	●	
Induction motor											●

Application: ■ suitable ■■ very suitable ■■■ optimum Equipment: ● present

18 V



Technical data	Cordless Mitre Saw KS 18 LTX 216	Cordless Mitre Saw KGS 18 LTX 216 with sliding function
Type of battery pack	Li-Ion / LiHD	Li-Ion / LiHD
Battery pack voltage	18 V	18 V
Cutting capacity 90°/90°	120 x 60 mm	305 x 65 mm
Cutting capacity 45°/45°	80 x 45 mm	205 x 36 mm
Turntable setting left/right	47 °/47 °	47 °/47 °
Saw blade inclination left/right	47 °/2 °	47 °/2 °
Saw blade	Ø 216 x 30 mm	Ø 216 x 30 mm
No-load speed	4,200 /min	4,200 /min
Max. cutting speed	48 m/s	48 m/s
Weight (including battery pack)	9.9 kg	13.9 kg

Scope of delivery

Order no.	619000	619001
Carbide saw blade (40 teeth)	■	■
2 Table width extensions	■	■
Length guide	■	■
Material clamp	■	■
Tool for saw blade change	■	■
Chip collection bag	■	■
2 LiHD battery packs (18 V/5.5 Ah)	■	■
2 LiHD battery packs (18V/8.0 Ah)	■	■
Charger ASC 30-36 V »AIR COOLED«	■	■

Equipment variants can be found in the Metabo price list and on the internet

Product advantages

- Up to 720 cuts in laminate 195 x 8 mm per battery pack charge (8.0 Ah)
- Sliding function for wide work pieces
- Depth guide for easy creation of grooves
- Powerful cordless mitre saw perfect for assembly jobs with high volume of cuts
- Up to 340 cuts in soft wood 60 x 60 mm per battery pack charge (8.0 Ah)
- Compact light weight, suitable also for one-handed transport
- Easy transport thanks to ergonomically-designed handles and locking saw head
- Motor brake for quick stop of the saw blade in 3 seconds
- Robust die-cast aluminium design for the highest demands
- Effective internal chip and dust extraction via dust scoop and chip collection bag
- Fast and precise setting of common angles using stop points
- Cutting line laser and LED work light with energy-saving automatic shutoff
- Adjustable and extendable table width extensions, removable to put long panels, slabs etc. underneath
- Sliding high rear fence profiles for safe sawing
- Material clamp for secure fixing of the work piece from the top or front

System components

Accessories → 378, 441 | Battery packs → 72 | Extraction systems → 453



Technical data	Mitre Saw KS 216 M Lasercut	Mitre Saw KGS 216 M with sliding function	Mitre Saw KGSV 216 M
Dimensions	475 x 465 x 285 mm	760 x 475 x 340 mm	760 x 475 x 340 mm
Cutting capacity 90°/90°	120 x 60 mm	305 x 65 mm	305 x 65 mm
Cutting capacity 45°/45°	80 x 45 mm	205 x 36 mm	205 x 36 mm
Turntable setting left/right	47 °/47 °	47 °/47 °	47 °/47 °
Saw blade inclination left/right	47 °/2 °	47 °/2 °	47 °/2 °
Saw blade	Ø 216 x 30 mm	Ø 216 x 30 mm	Ø 216 x 30 mm
Rated input power (S1 100% / S6 20%)	1,100 W / 1,350 W	1,200 W / 1,500 W	1,350 W / 1,700 W
No-load speed	5,000 /min	5,000 /min	2,500 - 5,500 /min
Cutting speed	57 m/s	57 m/s	28 - 62 m/s
Weight	9.4 kg	13.5 kg	13.5 kg
Cable length	2 m	2 m	2 m

Scope of delivery

Order no.	619216 <sup>1)</sup>	619260 <sup>2)</sup>	619261
Carbide saw blade (40 teeth)	■	■	
Carbide saw blade (60 teeth)			■
2 Table width extensions	■	■	■
Length guide	■	■	■
Material clamp	■	■	■
Tool for saw blade change	■	■	■
Chip collection bag	■	■	■
Cable winder		■	■

<sup>1)</sup> also available in 120 V (North/Latin America)

<sup>2)</sup> also available in 110 V (UK)

Product advantages

- Sliding function for wide work pieces
- Speed control for extended range of application, e.g. for cutting of aluminium profiles and plastics
- With »multi cut« saw blade (flat/trapezoidal tooth) for high cutting quality and long service life e.g. in laminate and aluminium profiles
- Sliding function for wide work pieces.
- Compact light weight, suitable also for one-handed transport
- Robust die-cast aluminium design for the highest demands
- Easy transport thanks to ergonomically-designed handles and locking saw head
- Effective dust extraction via integrated dust scoop
- Fast and precise setting of common angles using stop points
- Laser for exact display of the cutting line (mains powered, no batteries required)
- Adjustable and extendable table width extensions, removable to put long panels, slabs etc. underneath
- Bright LED work light for illumination of the cutting line (mains powered, no batteries required)
- Sliding high rear fence profiles for safe sawing
- Material clamp for secure fixing of the work piece from the top or front

System components

Accessories → 378, 441 | Extraction systems → 453



Technical data	Mitre Saw KGS 254 M with sliding function	Mitre Saw KS 305 M	Mitre Saw KGS 305 M with sliding function
Dimensions	790 x 515 x 515 mm	600 x 600 x 600 mm	850 x 515 x 615 mm
Cutting capacity 90°/90°	305 x 92 mm	200 x 80 mm / 150 x 102 mm	305 x 105 mm
Cutting capacity 45°/45°	205 x 47 mm	130 x 45 mm	205 x 67 mm
Turntable setting left/right	47 °/47 °	52 °/52 °	47 °/47 °
Saw blade inclination left/right	47 °/2 °	47 °/2 °	47 °/2 °
Saw blade	Ø 254 x 30 mm	Ø 305 x 30 mm	Ø 305 x 30 mm
Rated input power (S1 100% / S6 20%)	1,450 W / 1,800 W	1,600 W / 2,000 W	1,600 W / 2,000 W
No-load speed	4,500 /min	3,700 /min	3,700 /min
Cutting speed	60 m/s	60 m/s	60 m/s
Weight	16.3 kg	17 kg	19.6 kg
Cable length	2 m	2 m	2 m

Scope of delivery

Order no.	602540	619003	619305 <sup>2)</sup>
Carbide saw blade (48 teeth)	■		
Carbide saw blade (56 teeth)		■	■
2 Table width extensions	■	■	■
Length guide	■	■	■
Supplementary fence		■	
Material clamp	■	■	■
Tool for saw blade change	■	■	■
Cable winder	■	■	■
Chip collection bag	■	■	■

<sup>2)</sup> also available in 110 V (UK)

Product advantages

- Sliding function for wide work pieces
- Highest precision from direct saw head mount
- Enormous cutting performance due to extremely powerful universal motor and large saw blade
- Sliding function for wide work pieces
- Compact light weight, suitable also for one-handed transport
- Robust die-cast aluminium design for the highest demands
- Easy transport thanks to ergonomically-designed handles and locking saw head
- Effective dust extraction via integrated dust scoop
- Fast and precise setting of common angles using stop points
- Laser for exact display of the cutting line (mains powered, no batteries required)
- Adjustable and extendable table width extensions, removable to put long panels, slabs etc. underneath
- Bright LED work light for illumination of the cutting line (mains powered, no batteries required)
- Sliding high rear fence profiles for safe sawing
- Material clamp for secure fixing of the work piece from the top or front

System components

Accessories → 378, 441

Extraction systems → 453

## Unique combination of compact panel saw and precise skirting saw.

The new KGSV 72 Xact SYM mitre saw is a mobile all-rounder for floorers: It is the world's only saw to combine the classic functions of a mitre saw with a symmetrically adjustable stop system. Thanks to this patent-pending combination, users can accurately cut panels and also skirtings. The user can transfer angles directly from the bevel thanks to the symmetrically adjustable stop system, without any calculating and measuring, thus sawing mitres in a particularly accurate and time-saving manner. Constructed with integrated traction bars rather rear facing, the saw is also extremely compact and easy to transport. With its fine-toothed saw blade and sliding function with bearings on both sides, it delivers precise cutting results in floor panels up to 305 mm, skirtings and aluminium profiles.



**Speed control** for extended range of application, e.g. for cutting of aluminium profiles and plastics



**Superb dust collection** via integrated dust scoop



**Time-saving and accurate sawing of mitres** without calculating and measuring thanks to simple angle transfers from bevel to stop system



Extremely compact thanks to integrated traction bars

KGSV 72 Xact SYM



**Compact sliding function:** No space required behind the saw thanks to incorporated traction bars.



**Simple transfer of angles:** Transfer corner angles with bevel



**Symmetrical bevel system:** Transfer angle from bevel to stop system

01

02

03

04

05

06

07

08

09

10

11

12

13

14

15



Technical data	Mitre Saw KGSV 72 Xact with sliding function	Mitre Saw KGSV 72 Xact SYM with sliding function
Dimensions	660 x 540 x 415 mm	660 x 540 x 415 mm
Cutting capacity 90°/90°	305 x 72 mm	305 x 72 mm
Cutting capacity 45°/45°	215 x 42 mm	215 x 42 mm
Turntable setting left/right	50 °/50 °	50 °/50 °
Saw blade inclination left/right	47 °/47 °	47 °/47 °
Saw blade	216 mm	216 mm
Rated input power (S1 100% / S6 20%)	1,500 W / 1,800 W	1,500 W / 1,800 W
No-load speed	2,200 - 6,300 /min	2,200 - 6,300 /min
Cutting speed	25 - 70 m/s	25 - 70 m/s
Weight	16.1 kg	18.3 kg
Cable length	3 m	3 m

Scope of delivery

Order no.	611216	612216
Carbide saw blade (40 teeth)	■	
Carbide saw blade (60 teeth)		■
2 Table width extensions	■	■
Angle bevel		■
Material clamp	■	■
Tool for saw blade change	■	■
Cable winder	■	■

Product advantages

- Unique, patented combination of panel saw with sliding function and precise skirting saw with symmetrically adjustable stop system
- Time-saving and accurate sawing of mitres without calculating and measuring thanks to simple angle transfer from bevel to stop system
- With saw blade »multi cut« (flat/trapezoidal tooth) for high cutting quality and long service life e.g. in laminate and aluminium profiles
- Compact traction function for wide workpieces up to 305 mm: no space required behind the saw
- Maximum flexibility when sawing thanks to rotating table and inclinable saw head on both sides
- Double line laser for precise display of the cutting line left and right of the saw blade
- Speed control for extended range of application, e.g. for cutting of aluminium profiles and plastics
- Compact light-weight with ergonomically designed carry handles, ideal for mobile use
- Effective dust extraction via integrated dust scoop
- Fast and precise setting of common angles using stop points
- Bright LED work light for illumination of the cutting line (mains powered, no batteries required)
- Sliding high rear fence profiles for safe sawing
- Depth guide for easy creation of grooves

System components

Accessories → 378, 441

Extraction systems → 453



Technical data	Mitre Saw KGS 254 Plus	Mitre Saw KGS 254 I Plus	Mitre Saw KGS 315 Plus
Dimensions	930 x 690 x 590 mm	930 x 690 x 590 mm	950 x 765 x 660 mm
Cutting capacity 90°/90°	305 x 90 mm	305 x 90 mm	320 x 120 mm
Cutting capacity 45°/45°	214 x 54 mm	214 x 54 mm	223 x 76 mm
Turntable setting left/right	47 °/60 °	47 °/60 °	47 °/60 °
Saw blade inclination left/right	46 °/46 °	46 °/22.5 °	46 °/46 °
Saw blade	Ø 254 x 30 mm	Ø 254 x 30 mm	Ø 315 x 30 mm
Rated input power (S6 20%)	2,000 W	1,800 W	2,200 W
No-load speed	3,900 - 5,150 /min	4,650 /min	3,100 - 4,100 /min
Cutting speed	44 - 68 m/s	62 m/s	51 - 68 m/s
Weight	24 kg	32.5 kg	26 kg
Cable length	2 m	2.2 m	2.1 m

Scope of delivery

Order no.	0102540300 <sup>2)</sup>	0102540200	0103150000 <sup>2)</sup>
Carbide saw blade (60 teeth)	■	■	
Carbide saw blade (84 teeth)			■
2 Table width extensions	■	■	■
Material clamp	■	■	■
Adapter 35/58 mm	■	■	■

<sup>2)</sup> also available in 110 V (UK)

Product advantages

- Speed control for extended range of application, e.g. for cutting of aluminium profiles and plastics
- Quiet induction motor with motor brake and overload protection - maintenance-free and robust
- Enormous cutting performance due to extremely powerful universal motor and large saw blade
- Speed control for extended range of application, e.g. for cutting of aluminium profiles and plastics
- Maximum flexibility when sawing thanks to rotating table and inclinable saw head on both sides
- Sliding function for wide work pieces.
- Easy transport thanks to ergonomically-designed handles and locking saw head
- Superb dust extraction capability thanks to a dual extraction port design aligned closely to the work piece.
- Metabo Quick for changing saw blades without tools
- Soft start for long service life of motor and drive
- Fast and precise setting of common angles using stop points
- Sliding high rear fence profiles for safe sawing
- Material clamp for secure fixing of the work piece from the top or front
- Integrated, pull-out table width extensions made from die-cast aluminium
- Depth guide for easy creation of grooves

System components

Accessories → 378, 441

Extraction systems → 453



Technical data	Crosscut and Table Saw KGT 305 M
Dimensions	658 x 600 x 460 mm
Table size	462 x 261 mm
Cutting height – table mode	0 - 50 mm
Cutting width - cross cutting mode 90/45°	150 mm/100 mm
Cutting depth - cross cutting mode 90/45°	102 mm/70 mm
Cutting capacity 90°/90°	150 x 102 mm
Cutting capacity 45°/45°	115 x 45 mm
Turntable setting left/right	52 °/52 °
Saw blade inclination left/right	47 °/2 °
Rated input power (S1/S6 20%)	1,600 W / 2,000 W
No-load speed	3,700 /min
Max. cutting speed	60 m/s
Saw blade	Ø 305 x 30 mm
Weight	22 kg
Cable length	2.8 m

Scope of delivery	Order no.	619004
Carbide saw blade (56 teeth)		■
2 Table width extensions		■
Parallel guide / Rip fence		■
Length guide		■
Material clamp		■
Chip collection bag		■
Tool for saw blade change		■
Push stick		■

**Product advantages**

- Cross-cut and mitre saw with additional table circular saw function for straight cuts
- Quick changeover from crosscut to table operation
- Compact light-weight saw, ideal for mobile use
- Easy transport by means of locking saw head
- Robust die-cast aluminium design for the highest demands
- Fast and precise setting of common angles using stop points
- Laser for exact display of the cutting line (mains powered, no batteries required)
- Adjustable and extendable table width extensions, removable to put long panels, slabs etc. underneath
- Bright LED work light for illumination of the cutting line (mains powered, no batteries required)
- Sliding high rear fence profiles for safe sawing
- Material clamp for secure fixing of the work piece from the top or front
- Restart protection: prevents unintentional start-up after power supply interruption
- Saw head can be inclined to the left, with additional angle range for undercuts
- Easy saw blade change by means of spindle lock: No dismantling of the pendulum guard required

**System components**

Accessories → 378, 441

Extraction systems → 453

## Pull saws: pulling instead of pushing.

Anyone who has had to saw long, bulky or hardwood workpieces appreciates a pull saw. According to the principle "pulling instead of pushing", the saw accommodates your work and delivers particularly clean cuts. As in the pulling principle the saw blade moves along the precision guide to the workpiece fixed at the fence, the user has better control over the cut, thus resulting in less chipping. At the same time this procedure is gentle on the saw blades which significantly increases the lifetime of the same. Flush-mounted light running slides made of die cast aluminium with 8 ball bearings for clean and particularly precise cross cut and mitre cuts.

**Precise workpiece support**  
Table top made from aluminium profiles

**High-quality universal fence**  
for angle settings from -90° to +90°.



**Absolutely flexible**  
Powerful universal motor and speed control with Metabo VC electronics

**333 mm pulling length**  
All normal laminated floors and panels can be cut in two completely by up to 45°.

**Sturdy and safe**  
Side parts made of solid sheet steel

**Always firm**  
Integrated, folding stand with level compensation for a firm base. The machine can also be operated when folded.

**Practical accessories**  
For example, table length extension or sliding table – easy to mount.



UK 333



**Quick conversion**  
The UK 333 can be converted to a table saw. The universal fence becomes a parallel guide / rip fence for cutting long workpieces.



**Always mobile**  
The stand can be easily folded in. The UK 333 is very light to transport and fits into any car.



**Versatile cuts**  
The universal fence can be rotated by 180° for mitre and double-mitre cuts. The saw blade can be inclined from -1.5 to 46.5°; ideal for undercutting.

01  
02  
03  
04  
05  
06  
07  
08  
09  
10  
11  
12  
13  
14  
15





Technical data	Pull Saw UK 290	Pull Saw UK 290 Set
Dimensions	674 x 478 x 420 mm	1,600 x 1,180 x 420 mm
Working height	878 mm/420 mm	878 mm/420 mm
Table size	674 x 478 mm	674 x 478 mm
Cutting height	0 - 60 mm	0 - 60 mm
Maximum cutting height 90/45°	60 mm/42 mm	60 mm/42 mm
Maximum material width at mitre fence 90/45°	290 mm/202 mm	700 mm/750 mm
Maximum cutting width at parallel guide/rip fence	150 mm	615 mm
No-load speed	4,500 /min	4,500 /min
Saw blade	Ø 220 x 30 mm	Ø 220 x 30 mm
Inclination range	-1.5 - 46.5 °	-1.5 - 46.5 °
Cutting speed	52 m/s	52 m/s
Chain length	290 mm	290 mm
Rated input power	1,800 W	1,800 W
Weight (including stand)	25 kg	52 kg
Cable length	2.25 m	2.25 m

Scope of delivery

Order no.	0102900000	0192901000
Carbide saw blade (36 teeth)	■	■
Foldable stand	■	■
Universal guide	■	■
Fence profile 700 mm	■	■
Push stick	■	■
Chip and dust extraction unit UK / Flexo		■
Table width extension		■
Parallel guide / Rip fence		■
Table length extension		■
Sliding table		■

Product advantages

- Expandable for all common applications by virtue of system accessories
- Complete set with system accessories for all standard applications
- Sliding table, table width and length extension for precise sawing of large work pieces
- Mobile table saw with sliding function for precise cross-cuts and straight cuts
- Soft start for long service life of motor and drive
- Universal guide can be used on all sides of the table for cross-cuts and straight cuts
- Compact and easy transport by virtue of integrated, foldable stand
- Large selection of quickly mountable attachments available for an expanded range of use
- Electronic overload protection for long service life

System components

Accessories → 378, 439 | Extraction systems → 453



Technical data	Pull Saw UK 333	Pull Saw UK 333 Set
Dimensions	760 x 585 x 420 mm	1,600 x 1,287 x 420 mm
Working height	900 mm/420 mm	900 mm/420 mm
Table size	750 x 585 mm	750 x 585 mm
Cutting height	0 - 70 mm	0 - 70 mm
Maximum cutting height 90/45°	70 mm/49 mm	70 mm/49 mm
Maximum material width at mitre fence 90/45°	330 mm/230 mm	700 mm/750 mm
Maximum cutting width at parallel guide/rip fence	210 mm	685 mm
No-load speed	1,800 - 4,500 /min	1,800 - 4,500 /min
Saw blade	Ø 220 x 30 mm	Ø 220 x 30 mm
Inclination range	-1.5 - 46.5 °	-1.5 - 46.5 °
Cutting speed	52 m/s	52 m/s
Chain length	333 mm	333 mm
Rated input power	2,200 W	2,200 W
Weight (including stand)	35.9 kg	63 kg
Cable length	2.25 m	2.25 m

Scope of delivery

Order no.	0103330000	0193330000
Carbide saw blade (36 teeth)	■	■
Foldable stand	■	■
Universal guide	■	■
Fence profile 700 mm	■	■
Push stick	■	■
Chip and dust extraction unit UK / Flexo		■
Table width extension		■
Parallel guide / Rip fence		■
Table length extension		■
Sliding table		■

Product advantages

- Expandable for all common applications by virtue of system accessories
- Complete set with system accessories for all standard applications
- Sliding table, table width and length extension for precise sawing of large work pieces
- Mobile table saw with sliding function for precise cross-cuts and straight cuts
- Vario-Constamatic (VC)-Full wave electronics for working at customised speeds to suit the application materials, and speeds that remain almost constant even under load
- Electronic overload protection for long service life
- Soft start for long service life of motor and drive
- Universal guide can be used on all sides of the table for cross-cuts and straight cuts
- Compact and easy transport by virtue of integrated, foldable stand
- Flush-mounted free running slides made of die cast aluminium and with 8 ball bearings for maximum precision

System components

Accessories → 378, 439 | Extraction systems → 453

# Light, compact table saws: The standard for mobility.

The table saws with integrated stand are extremely light and can be set up and dismantled in a matter of seconds. The heart of our patent-pending mobility concept is the integrated stand and wheel set which is housed within the frame. Thanks to this design, the TS models are very compact and can be stored easily occupying little space. With the robust hard rubber tyres you can comfortably pull the saw to the area of application. Whether in the workshop or on the construction site: The TS set a mobility standard for table saws. Now also as cordless version for 36 Volt or 2x 18 Volt.

Splitting wedge can be lowered without tools for hidden cuts and transport

Table width extension/  
parallel guide/rip fence  
with double guide and fine adjustment  
for precise working



Operational safety thanks to table length extension, safety switch, quick motor brake and restart protection



Optimised for transport: All attachments such as mitre fence, parallel guide/rip fence, and second saw blade can be safely stored in the housing.

Durable design of motor and gear thanks to electronic overload protection and soft start

Integrated stand made from stable die-cast aluminium: Unfolded in a matter of seconds, with secure positioning

TS 254

# 2x 18 V 36 V

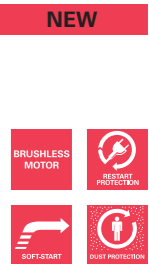
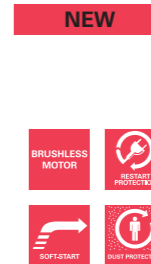

### Technical data

	Cordless Table Saw TS 36-18 LTX BL 254	Cordless Table Saw TS 36 LTX BL 254
Type of battery pack	Li-Ion / LiHD	Li-Ion / LiHD
Battery pack voltage	18 V	36 V
Max. support surface	970 x 995 mm	970 x 995 mm
Cutting height	0 - 87 mm	0 - 87 mm
Maximum cutting height 90/45°	87 mm/50 mm	87 mm/50 mm
Maximum cutting width at parallel guide/rip fence	630 mm	630 mm
Maximum material width at mitre fence	200 mm	200 mm
No-load speed	5,000 /min	5,000 /min
Max. cutting speed	66 m/s	66 m/s
Saw blade	Ø 254 x 30 mm	Ø 254 x 30 mm
Saw blade swivel range	-1.5 - 46.5 °	-1.5 - 46.5 °
Weight (including battery pack)	34.6 kg	34.5 kg

### Scope of delivery

Order no.	613025	613024
Carbide saw blade (40 teeth)	■	■
Stand	■	■
Rubber tyres	■	■
Parallel guide / Rip fence	■	■
Mitre fence	■	■
Table length extension	■	■
Table width extension	■	■
Dust cycles	■	■
Textile dust bag	■	■
2 LiHD battery packs (36 V/6.2 Ah)	■	■
4 LiHD battery packs (18 V/8.0 Ah)	■	■
»AIR COOLED« quick charger ASC Ultra	2	1
Fixation strap for MetaLoc	■	■
MetaLoc case	■	■

Equipment variants can be found in the Metabo price list and on the internet

### Product advantages

- 100% compatibility with the 18 Volt class: powerful 36 Volt operation with two 18 Volt battery packs from Metabo
- Extremely light cordless table saw with trolley function for maximum mobility
- Powerful Metabo brushless motor for powerful sawing like with a mains-powered tool
- Integrated extraction with dust cyclone for low-dust working without vacuum cleaner
- Quick change between sawing at ground-level or when standing up thanks to integrated, folding stand
- Precisely adjustable parallel guide / rip fence with double clamping and quick fastening
- Splitting wedge can be lowered without tools for hidden cuts and transport
- MetaLoc case and attachments can be fixed at the housing for compact transport and storage

### System components

Accessories → 378 | Battery packs → 72 | Extraction systems → 453



Trolley function for increased mobility and ready for use after transport in a matter of seconds



Large workpieces - no problem  
Generous 87 mm cutting height and 630 mm cutting width at the parallel guide/rip fence (TS 36 LTX BL 254, TS 36-18 LTX BL 254 and TS 254).



Light and compact  
The TS 216 can even be carried with one hand thanks to its light weight and compact design.



Technical data	Table Saw TS 216 Floor	Table Saw TS 216	Table Saw TS 254
Dimensions	670 x 650 x 355 mm	670 x 730 x 355 mm	740 x 750 x 355 mm
Max. support surface	780 x 930 mm	780 x 930 mm	970 x 995 mm
Cutting height	0 - 63 mm	0 - 63 mm	0 - 87 mm
Maximum cutting height 90/45°	63 mm/43 mm	63 mm/43 mm	87 mm/50 mm
Maximum cutting width at parallel guide/rip fence	425 mm	425 mm	630 mm
Maximum material width at mitre fence	165 mm	165 mm	200 mm
No-load speed	5,000 /min	5,000 /min	4,200 /min
Cutting speed	57 m/s	57 m/s	56 m/s
Saw blade	Ø 216 x 30 mm	Ø 216 x 30 mm	Ø 254 x 30 mm
Saw blade swivel range	-1.5 - 46.5 °	-1.5 - 46.5 °	-1.5 - 46.5 °
Rated input power	1,500 W (S1)	1,500 W (S1)	1,700 W/2,000 W (S1/S6 20%)
Weight	23.2 kg	28.5 kg	33.4 kg
Cable length	3 m	3 m	3.1 m

Scope of delivery	600676	600667	600668
Order no.	600676	600667	600668
Carbide saw blade (30 teeth)	■	■	
Carbide saw blade (40 teeth)			■
Stand		■	■
Hard rubber tyres		■	■
Parallel guide / Rip fence	■	■	■
Mitre fence	■	■	■
Table length extension	■	■	■
Table width extension (left)	■	■	■
Table width extension (right)	■	■	■
Saw blade case			■
Chip and dust extraction unit	■	■	
Push stick	■	■	■

- Product advantages**
- Light table saw, also suitable for one-handed transport
  - Light table saw with trolley function
  - Integrated stand made from stable die-cast aluminium (patented): unfolded in a matter of seconds with secure stand
  - Very compact with folded stand for comfortable transport and space-saving storage
  - Anti-twist tubular frame construction for highest demands on the building site and during installations
  - Cables and all attachments for transport can be stored on the casing
  - Powerful motor with electronic overload protection
  - Motor brake for quick stop of the saw blade in 3 seconds
  - Precise parallel guide/rip fence with double clamping and quick fastening
  - Precise saw blade inclination via gear guide
  - Splitting wedge can be lowered without tools for hidden cuts and transport
  - Precise, extendable table width extension for extra large support surface
  - Effective chip extraction for low-dust working

**System components**  
 Accessories → 378 | Extraction systems → 453

## Table saws: Powerful and robust.

Universal table saws for powerful sawing of squared timber, boards, panels and wood-like materials in the workshop and at construction sites. With our circular saws we offer you stable and reliable machines. Every detail is carefully planned, starting with the infinitely adjustable height of the saw blade to the magnetic guide for precise cuts.

**Professionally assembled**  
 Always ready for use in cutting squared timber, boards and large panels.



**Powerful 2.0 kW-Motor**  
 Reliable induction motor for universal application

**Stable stand**  
 Cross braces offer additional stability



**Standard push stick**  
 Always stored on the machine - for your safety.

**Wheel set with handles**  
 Easy moving of the machine by a single person.

**Height adjustment up to max. 85 mm**  
 The smooth crank handle enables the height adjustment of the saw blade of 0 – 85 mm

TKHS 315 C



**Always mobile**  
 Standard wheel set with two handles for mobile use.



**High capacity**  
 The well thought construction permits a max. cutting height of up to 85 mm and 60 mm at 45° angle of the saw blade.



**Versatile sawing**  
 The universal fence may be used as a parallel or mitre fence (from - 60° to +60°). Thanks to the magnetic guide precise cuts are possible.



Technical data	Table Saw TKHS 315 C - 2,0 WNB	Table Saw TKHS 315 C - 2,8 DNB	Table Saw TKHS 315 M - 3,1 WNB	Table Saw TKHS 315 M - 4,2 DNB
Dimensions	1,650 x 650 x 1,000 mm	1,650 x 650 x 1,000 mm	1,700 x 700 x 1,000 mm	1,700 x 700 x 1,000 mm
Max. support surface	800 x 550 mm	800 x 550 mm	800 x 600 mm	800 x 600 mm
Working height	850 mm	850 mm	850 mm	850 mm
Cutting height	0 - 85 mm	0 - 85 mm	0 - 85 mm	0 - 85 mm
Maximum cutting height 90/45°	85 mm/60 mm	85 mm/60 mm	85 mm/53 mm	85 mm/53 mm
Maximum cutting width at parallel guide/rip fence	290 mm	290 mm	340 mm	340 mm
Maximum material width at mitre fence	220 mm	220 mm	250 mm	250 mm
No-load speed	2,980 /min	2,990 /min	2,990 /min	2,990 /min
Cutting speed	50 m/s	50 m/s	50 m/s	50 m/s
Saw blade	Ø 315 x 30 mm	Ø 315 x 30 mm	Ø 315 x 30 mm	Ø 315 x 30 mm
Saw blade swivel range	0 - 45 °	0 - 45 °	0 - 45 °	0 - 45 °
Rated input power	2,000 W	2,800 W	3,100 W	4,200 W
Weight	62 kg	64 kg	75 kg	77 kg

Scope of delivery

Order no.	0103152000	0103152100	0103153100	0103153300
Carbide saw blade (24 teeth)	■	■	■	■
Wheel set incl. handles	■	■	■	■
Universal guide	■	■	■	■
Parallel guide / Rip fence			■	■
Mitre fence			■	■
Table length extension (550 x 800 mm)	■	■		
Table length extension (600 x 800 mm)			■	■
Chip and dust extraction unit	■	■	■	■
Push stick	■	■	■	■

Product advantages

- High torque three-phase motor
- High torque three-phase motor
- Universal table saw with basic equipment
- Universal guide with magnetic guide for precise straight cuts and mitre cuts
- Precise, powerful table saw in professional configuration – quick to adapt for every application
- Mitre fence with linear stop, can also be used as a sliding table
- Sturdy parallel guide/rip fence with quick fastening
- Freely height-adjustable saw blade
- Restart protection: prevents unintentional start-up after power supply interruption
- Ideal for sawing squared timber, boards, panels and wood-like materials in the workshop and on construction sites
- Quiet induction motor with motor brake and overload protection - maintenance-free and robust
- Comfortable setting of the saw blade inclination from the front
- Sturdy, powder-coated sheet steel design and galvanised table-top
- Foldable table length extension

System components

Accessories → 378, 440

Extraction systems → 453

## Site saws: For very demanding applications on the construction site.

If you do not want to leave anything to chance on the construction site, Metabo's site saws are the ideal choice. The robust machines are universal talents for demanding applications on the construction site. They cut squared timber, control panels, OSB panels and beams. The stable construction with folding saw table and guard meet the European Safety Standard EN 1870-1 and can live up to the highest demands in every day jobs on a construction site.

**Long saw table**  
Foldable saw table made of galvanised sheet steel.

**Safety equipment**  
The guard as well as the complete machine meets the requirements of the European Safety Standard EN 1870-1.



**Powerful 5.5 kW motor with overload protection** ensures sufficient power reserves for demanding jobs

**User friendly** thanks to patented single lever height adjustment of the saw blade

**Always firm**  
The sturdy frame is powder-coated, the lateral beams ensure ideal resistance to torsion.

**Safe operation** thanks to switch with integrated emergency-off switch and phase inverter in the plug

BKH 450 Plus



**Well protected**  
The guard automatically opens only at the height of the work piece and closes again automatically.



**Practical**  
Crane hook for easy transport on the construction site.



**Extremely stable**  
Very high torsional resistance due to lateral cross braces.



Technical data	Site Saw BKS 400 Plus - 3,1 WNB	Site Saw BKS 400 Plus - 4,2 DNB	Site Saw BKS 450 Plus - 5,5 DNB	Site Saw BKH 450 Plus - 5,5 DNB
Dimensions	1,830 x 750 x 1,020 mm	1,830 x 750 x 1,020 mm	1,830 x 750 x 1,020 mm	1,830 x 750 x 1,020 mm
Table size	1,030 x 660 mm	1,030 x 660 mm	1,030 x 660 mm	1,030 x 660 mm
Maximum cutting width with parallel guide/rip fence	300 mm	300 mm	300 mm	300 mm
Maximum cutting width with supplementary table	1,300 mm	1,300 mm	1,300 mm	1,300 mm
Maximum material width with mitre fence	260 mm	260 mm	260 mm	260 mm
Cutting height	127 mm	127 mm	141 mm	20 - 140 mm
Revolutions at rated load	2,800 /min	2,750 /min	2,735 /min	2,750 /min
Cutting speed	58 m/s	58 m/s	66 m/s	68 m/s
Saw blade	Ø 400 x 30 mm	Ø 400 x 30 mm	Ø 450 x 30 mm	Ø 450 x 30 mm
Rated input power	3,100 W (S6 40%)	4,200 W (S6 40%)	5,500 W (S6 40%)	5,500 W (S6 40 %)
Output power	2,350 W (S6 40%)	3,250 W (S6 40%)	3,200 W (S1 100%)	3,200 W (S1 100 %)
Weight	88 kg	88 kg	90 kg	102 kg

Scope of delivery

Order no.	0104003000	0104004000	0104605000	0104705000
Carbide saw blade (28 teeth)	■	■		
Carbide saw blade (32 teeth)			■	■
Parallel guide / Rip fence	■	■	■	■
Mitre fence with wedge type charge	■	■	■	■
Table length extension	■	■	■	■
Crane hook	■	■	■	■
Phase inverter		■	■	■
Push stick	■	■	■	■

Product advantages

- High torque three-phase motor
- Patented single-lever height adjustment for quick adjustment of the cutting height to the work piece
- Designed for continuous mode with S1 motor operating mode
- High torque three-phase motor
- Robust machine with large cutting height for universal use on the construction site
- Easy to use protective cover for safe working
- High user safety thanks to splash-proofed switch and motor
- Corrosion protection thanks to saw table made of galvanised sheet steel
- Robust parallel guide/rip fence with quick eccentric clamp
- Push stick ready to use on parallel guide/rip fence for increased safety
- Retractable mitre fence with wedge type charge
- More safety and long service life thanks to motor brake and overload protection
- Restart protection: prevents unintentional start-up after power supply interruption
- Table length extension for long work pieces, foldable

System components

Accessories → 378

Extraction systems → 453



Our circular saw blades can be found in chapter 8 from page 378





- power cut**
  - For fast coarse and semi-fine cuts with continuous feed for low performance requirements
  - Good cutting results for straight cuts in solid wood
- precision cut**
  - Very wide range of uses in woodwork
  - For very good, clean cut results for longitudinal or cross-cuts in softwood and hardwood
- multi cut**
  - Universal use for demanding materials
  - For the highest standards in cutting quality, e.g. for laminate, plastic, aluminium, copper and bronze materials

Attachments and Special Accessories

Accessories for pull saws / Flexo 500

	Order no.
 <p><b>Wheel set</b></p> <ul style="list-style-type: none"> <li>■ For easy transportation</li> </ul> <p>suitable for: UK 290, UK 333, Flexo 500</p>	0910064363
 <p><b>Sliding table UK / Flexo</b></p> <ul style="list-style-type: none"> <li>■ Large and wide work pieces can be easily guided through the saw blade</li> <li>■ Clean and precise cutting results</li> <li>■ Easy to mount and remove</li> <li>■ Safe working conditions</li> </ul> <p>suitable for: UK 290, UK 333, Flexo 500 Table size: 310 x 200 mm Overall length: 1,225 mm Support weight: 7.7 kg</p>	0910064347
 <p><b>Table length extension UK / Flexo</b></p> <ul style="list-style-type: none"> <li>■ Practical cutting lengths for longer work pieces</li> <li>■ Safe working conditions</li> </ul> <p>suitable for: UK 290, UK 333, Flexo 500 Length: 380 mm Width: 476 mm</p>	0910064312
 <p><b>Table width extension UK / Flexo</b></p> <ul style="list-style-type: none"> <li>■ Increases the support surface; ideal for large boards</li> <li>■ Enables cuts with parallel guide/rip fence of up to 610 mm</li> <li>■ Height adjustable</li> </ul> <p>suitable for: UK 333, UK 290, Flexo 500 Length: 674 mm Width: 501 mm</p>	0910064401
 <p><b>Parallel guide/rip fence UK / Flexo</b></p> <ul style="list-style-type: none"> <li>■ For long cuts or for cutting large boards</li> <li>■ Long attachment profile for guiding the work piece safely</li> </ul> <p>suitable for: UK 290, UK 333, Flexo 500</p>	0910063707
 <p><b>Chip and dust extraction unit UK / Flexo</b></p> <ul style="list-style-type: none"> <li>■ Extraction at two points: at chip box and at the top on the guard</li> <li>■ Clear view of the work piece</li> <li>■ Clean working environment</li> </ul> <p>Extraction nozzle Ø: 100 mm suitable for: UK 290, UK 333, Flexo 500</p>	0910064371

Machine stand		Order no.
 <p><b>Machine stand UMS</b></p> <ul style="list-style-type: none"> <li>For ideal working height and stability</li> <li>Can be folded up compactly</li> <li>Compensation in height with adjustable stand</li> <li>Ready mounted</li> </ul> <p>Height of work bench: 83 cm Weight: 12 kg Maximum weight load: 250 kg Support surface 57 x 60 cm suitable for: KS 216 M Lasercut, KGS 216 M, KGS 254 M, KGS 305 M, KGS 216 Plus, KGS 254 Plus / KGS 254 I Plus, KGS 315 Plus, KS 254 Plus, KS 305 Plus, KS 305 M, KGT 300, KGT 305 M, BAS 260 Swift, BAS 261 Precision, DH 330, KGSV 72 Xact / KGSV 72 Xact SYM</p>		631317000

Sliding table		Order no.
 <p><b>TKHS sliding table</b></p> <ul style="list-style-type: none"> <li>Enables exact cuts, even on larger workpieces</li> <li>Precise sliding table on 6 ball bearings</li> <li>Complete with fence guide, swivels 90-45°</li> <li>Fence pointer for precise repeated cuts</li> </ul> <p>suitable for: TKHS 315, TKHS 315 C, TKHS 315 M Maximum cutting width 90°/45°: 640 mm/930 mm Overall length: 1,270 mm Support weight: 24 kg</p>		0910058967

Workpiece clamps		Order no.
 <p><b>Workpiece clamp KGS / KGT</b></p> <ul style="list-style-type: none"> <li>For the secure clamping of smaller workpieces, plastic or aluminium profiles</li> </ul> <p>suitable for: KGS 255, KGS 303, KGS 305, KGT 300, KGT 501, KS 210 C, KS 210 Lasercut, KGT 501 from YOM 2003</p>		0910057553*

## Stands for mitre saws: Ideal for the construction site and the workshop.

All Metabo mitre saws, as well as all standard models of renowned manufacturers, can be mounted on the new light and robust KSU 401, and KSU 251 stands, quickly and without tools. Thanks to the trolley function, which Metabo designed for construction sites and staircases, the large handles and the ability to fold the legs with one only hand, has optimised the stands for transport. Even with the saw mounted, the stands can be folded with just a few hand movements and can be comfortably pulled to and from the workplace. They are extremely robust and stable and are suitable both for use on construction sites as well as in the workshop.

**Robust and light design**  
with max. weight load in central part of 250 kg

**Extendable workpiece supports**  
up to 400 cm with rollers and folding guide for precise cutting in series

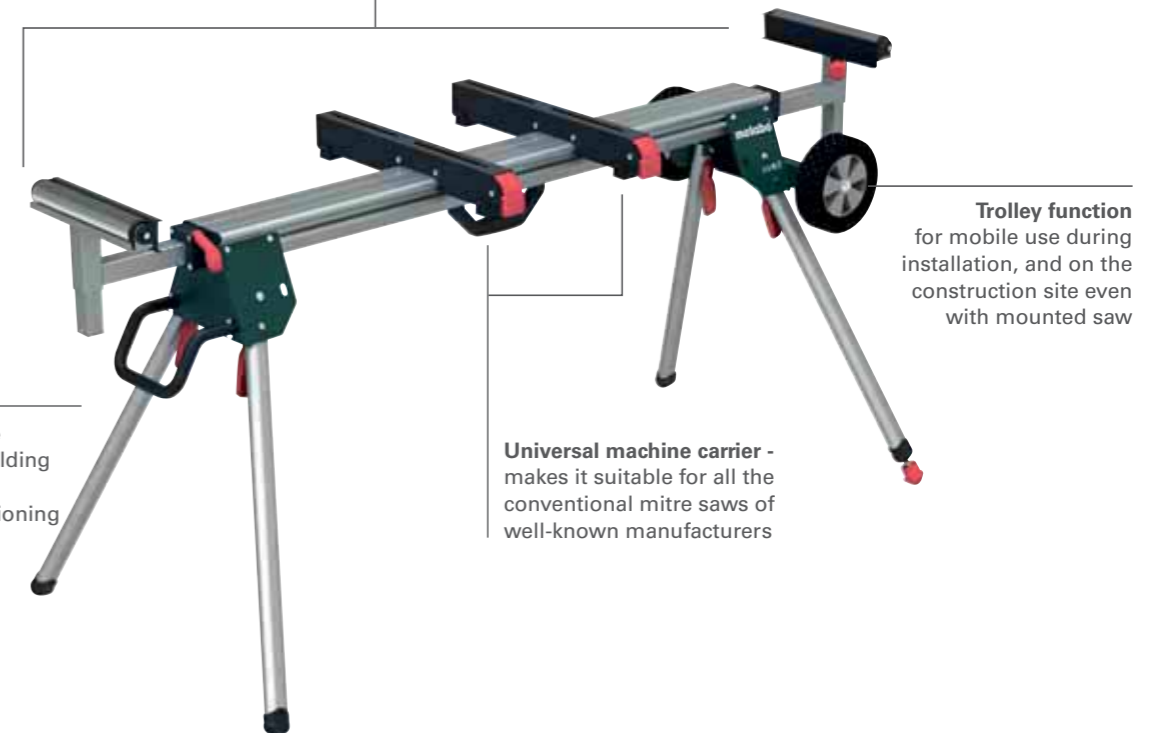

**Quickly ready to use**  
thanks to lockable folding legs and adjustment option for safe positioning

**Universal machine carrier** - makes it suitable for all the conventional mitre saws of well-known manufacturers

**Trolley function**  
for mobile use during installation, and on the construction site even with mounted saw

KSU 401



**KSU 251:**  
Compact design for easy transport



**Trolley function**  
for comfortable transport even with the saw mounted





**Folding function by actuating lever**  
for quick, single-handed folding and unfolding

\*Self-service packaging

01  
02  
03  
04  
05  
06  
07  
08  
09  
10  
11  
12  
13  
14  
15

Special accessories for mitre saws		Order no.
 <p><b>Stand for mitre saws KSU 100</b></p> <ul style="list-style-type: none"> <li>■ Light and robust stand for mitre saws</li> <li>■ Quickly ready to use thanks to lockable folding legs</li> <li>■ Extendable workpiece supports with rollers and folding guide for precise cutting in series (available as accessory)</li> <li>■ Including machine carrier (installation without tools) makes it suitable for all conventional mitre saws of well-known manufacturers</li> </ul> <p>Overall length: 100 cm Maximum weight load in central part: 250 kg Weight: 16 kg</p>	629004000	
 <p><b>KSU 251 Stand for mitre saws</b></p> <ul style="list-style-type: none"> <li>■ Light and robust stand for mitre saws with trolley function for mobile use also with mounted saw</li> <li>■ Quickly ready to use thanks to lockable folding legs and adjustment option for safe positioning</li> <li>■ Extendable workpiece supports with rollers and folding guide for precise cutting in series</li> <li>■ Including machine carrier (installation without tools) makes it suitable for all conventional mitre saws of well-known manufacturers</li> </ul> <p>Overall length: 127 cm – 250 cm Height of workpiece supports: 92 cm - 99 cm Maximum weight load in central part: 250 kg Weight: 23 kg</p>	629005000	
 <p><b>KSU 401 Stand for mitre saws</b></p> <ul style="list-style-type: none"> <li>■ Light and robust stand for mitre saws with trolley function for mobile use also with the saw mounted</li> <li>■ Quickly ready to use thanks to lockable folding legs and adjustment option for safe positioning</li> <li>■ Extendable workpiece supports with rollers and folding guide for precise cutting in series</li> <li>■ Including machine carrier (installation without tools) makes it suitable for all conventional mitre saws of well-known manufacturers</li> </ul> <p>Overall length: 168 cm - 400 cm Height of workpiece supports: 92 cm - 99 cm Maximum weight load in central part: 250 kg Weight: 25 kg</p>	629006000	
 <p><b>Machine stand UMS</b></p> <ul style="list-style-type: none"> <li>■ For ideal working height and stability</li> <li>■ Can be folded up compactly</li> <li>■ Compensation in height with adjustable stand</li> <li>■ Ready mounted</li> </ul> <p>Height of work bench: 83 cm Weight: 12 kg Maximum weight load: 250 kg Support surface 57 x 60 cm suitable for: KS 216 M Lasercut, KGS 216 M, KGS 254 M, KGS 305 M, KGS 216 Plus, KGS 254 Plus / KGS 254 I Plus, KGS 315 Plus, KS 254 Plus, KS 305 Plus, KS 305 M, KGT 300, KGT 305 M, BAS 260 Swift, BAS 261 Precision, DH 330, KGSV 72 Xact / KGSV 72 Xact SYM</p>	631317000	

 <p><b>Machine carrier KSU 100/251/401</b></p> <ul style="list-style-type: none"> <li>■ For the easy and safe installation of tall standard mitre saws of renowned manufacturers on the machine stands KSU 100, KSU 251 and KSU 401</li> <li>■ Contents: 2 pieces</li> </ul>	629008000	Order no.
<p><b>Workpiece support KSU 100</b></p> <ul style="list-style-type: none"> <li>■ 1 extendable workpiece support with rolls and foldable guide for precise cuts in series</li> <li>■ can be used left or right</li> </ul>	629009000	Order no.

Roller stands		Order no.
 <p><b>Roller stand RS 420</b></p> <ul style="list-style-type: none"> <li>■ For supporting long workpieces when sawing, moulding/routing, planing and drilling</li> <li>■ Sturdy, height-adjustable and foldable</li> </ul> <p>With smooth-rolling rollers with a high load capacity Width: 400 mm Base weight: 100 kg Height: 640 - 1,015 mm</p>	0910053353	Order no.

Spray for maintenance and care		Order no.
 <p><b>Spray for maintenance and care</b></p> <ul style="list-style-type: none"> <li>■ Ideal for maintenance and care of wood processing machines</li> <li>■ Contains silicone, prevents saw dust from sticking, e.g. to threaded rods or sliding bearings</li> <li>■ Increases the sliding quality of the workpieces on the machine table</li> <li>■ High cleaning capacity</li> </ul> <p>Contents: 400 ml</p>	0911018691*	Order no.

Lubricant		Order no.
 <p><b>Waxilit - lubricant</b> Weight: 70 g</p>	0911001071	Order no.
 <p><b>Waxilit - lubricant</b> Weight: 1,000 g</p>	4313062258	Order no.

\*Self-service packaging



Technical data	
<b>Band Saw BAS 261 Precision</b>	
Dimensions	530 x 470 x 840 mm
Support surface	328 x 335 mm
Working height without stand	375 mm
Sawing bench swivel range	0 - 45 °
Cutting height	103 mm
Passage width	245 mm
Cutting speed	735 m/min
Saw belt length	1,712 mm
Rated input power	400 W
Output power	270 W
Weight	32.5 kg

**Scope of delivery**

Order no.	619008
Universal band saw blade A6	■
Parallel guide / Rip fence	■
Mitre fence	■
Suction adapter (for Ø 44, 58, 100 mm)	■
Push stick	■

**Product advantages**

- High precision and stability for highest cutting quality
- Quiet belt path thanks to balanced flywheels with rubber coating
- Top and bottom HSS precision three-roller guide of the band saw blade for accurate cutting results, adjustable without tools
- Precise parallel guide/rip fence with double clamping and quick fastening
- Quiet induction motor, maintenance-free and robust.
- Restart protection: prevents unintentional start-up after power supply interruption
- Swivelling grey cast iron saw table for inclined cuts
- Door opening without tools for easy saw blade change
- Tool-less height adjustment of the saw blade guard
- LED work light for illumination of the cutting line
- External extraction possible for low-dust working
- Radii cutting with circle sawing attachment (accessory)

**System components**

Accessories → 447 | Extraction systems → 453



Technical data	
<b>Band Saw BAS 318 Precision WNB</b>	
Dimensions	665 x 980 x 1,600 mm
Support surface	560 x 400 mm
Working height with stand	1,000 mm
Sawing bench swivel range	0 - 45 °
Cutting height	170 mm
Passage width	307 mm
Cutting speed	410 / 880 m/min
Saw belt length	2,240 mm
Rated input power	900 W
Output power	660 W
Weight	79 kg

**Scope of delivery**

Order no.	619009	619010
Universal band saw blade A6	■	■
Stand	■	■
Parallel guide / Rip fence	■	■
Mitre fence	■	■
Suction adapter (for Ø 44, 58, 100 mm)	■	■
Dust collection container	■	■
Push stick	■	■

**Product advantages**

- High precision and stability for highest cutting quality
- Quiet belt path thanks to balanced flywheels with rubber coating
- Top and bottom HSS precision three-roller guide of the band saw blade for accurate cutting results, adjustable without tools
- Two cutting speeds for various applications and materials
- Precise parallel guide/rip fence with double clamping and quick fastening
- Quiet induction motor, maintenance-free and robust.
- Restart protection: prevents unintentional start-up after power supply interruption
- Easy inclination adjustment of the grey cast iron saw table for precise incline cuts thanks to toothed ring guide
- Quick-action clamping lever and door opening without tools for easy saw blade change
- Blade clamp indicator with scale for easy control of the blade tension
- Tool-less height adjustment of the saw blade guard
- LED work light for illumination of the cutting line
- External extraction possible for low-dust working
- Drawer for simple disposal of collected sawdust
- Extendable table width extension for processing large workpieces
- Radii cutting with circle sawing attachment (accessory)
- Regrinding surfaces and curved sawing cuts with belt sanding attachment (accessory)
- Stand with wheels for comfortable change of position

**System components**

Accessories → 447 | Extraction systems → 453

01

02

03

04

05

06

07

08

09

10

11

12

13

14

15





Technical data	Band Saw BAS 505 Precision WNB	Band Saw BAS 505 Precision DNB
Dimensions	834 x 639 x 1,860 mm	834 x 639 x 1,860 mm
Support surface	536 x 640 mm	536 x 640 mm
Working height without stand	925 mm	925 mm
Sawing bench swivel range	0 - 20 °	0 - 20 °
Cutting height	280 mm	280 mm
Passage width	440 mm	440 mm
Cutting speed	430 / 1,020 m/min	430 / 1,020 m/min
Saw belt length	3,380 mm	3,380 mm
Rated input power	1,500 W	1,900 W
Output power	1,100 W	1,500 W
Weight	133 kg	133 kg

Scope of delivery	605052	605053
Order no.		
Universal band saw blade A6	■	■
Parallel guide / Rip fence	■	■
Extraction nozzle (Ø 100 mm)	■	■

- Product advantages**
- High precision and stability for highest cutting quality
  - Two cutting speeds for various applications and materials
  - Top and bottom HSS precision three-roller guide of the band saw blade for best cutting results, adjustable without tools
  - Quiet induction motor, maintenance-free and robust.
  - Restart protection: prevents unintentional start-up after power supply interruption
  - Easy inclination adjustment of the grey cast iron saw table for precise incline cuts thanks to toothed ring guide
  - Door opening without tools for easy saw blade change
  - Viewing window for blade clamp indicator for fast control of the blade clamping from outside
  - Tool-less height adjustment of the saw blade guard
  - Attachments can be stored in the saw housing
  - External extraction possible for low-dust working
  - Radii cutting with circle sawing attachment (accessory)

**System components**  
 Accessories → 447 | Extraction systems → 453

## Band Saw Blades

### Band saw blades for wood and plastic



- A2 Helical tooth for small radii**  
Wood, plastic, fine sawing attachment required
- A4 Helical tooth for curved cuts**  
Wood, plastic
- A6 Peg tooth for curved cuts**  
Wood, plastic
- A6 Helical tooth for straight cuts**  
Wood, plastic
- A6 Helical tooth for straight cuts**  
Wood, plastic
- A18 Helical tooth for straight cuts**  
Firewood

### Band saw blades for metal and foam materials

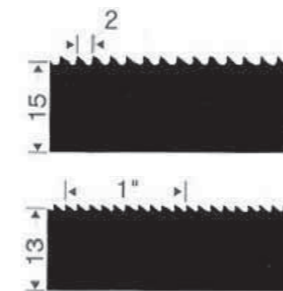

- A2 Rake tooth for universal cuts**  
Aluminium, copper, brass, foam materials
- 14TPI, 14/18 TPI, 18TPI Rake tooth for universal cuts**  
Aluminium, copper, brass, steel

### Designation of the band saw blades

Example:

**Top edge induction hardened**  
**2240 x 6 x 0.5/A – 4 (14 TPI)**

**Top edge induction hardened** = tooth tip induction hardened  
 Carbon steel with induction hardened tooth tips;  
 very economical thanks to high useful life

- 2240** = band length mm
- 6** = band width mm
- 0.5** = band thickness mm
- A – 4** = clearance of tooth tips mm
- 14 TPI = A2** = number of teeth per inch unit
- 1.3 TPI = A18** = number of teeth per inch unit

Band saw blades for wood and plastic



- Carbon steel with induction hardened teeth
- Very economical due to its long useable working life

Dimensions mm	Tooth pitch	Material suitability	Suitable for	Order no.
1,505 x 6 x 0.36	A4 helical tooth	Wood, plastics, aluminium, especially for curved cuts	BS 230 up to 2001	0909040817*
1,505 x 12 x 0.36	A6 peg tooth	Wood, plastics, aluminium	BS 230 up to 2001	0909040825*
1,712 x 6 x 0.36	A4 helical tooth	Wood, plastics, aluminium, especially for curved cuts	BAS 260 Swift	0909057175*
1,712 x 12 x 0.36	A6 peg tooth	Wood, plastics, aluminium	BAS 260 Swift	0909057183*
1,810 x 6 x 0.35	A4 helical tooth	for curved cuts (curves), wood, wood-like materials, plastics	BS 5370, BS 5378	627641000*
1,810 x 10 x 0.35	A6 peg tooth	for curved cuts with larger radius, wood, wood-like materials, plastics	BS 5370, BS 5378	627642000*
1,810 x 13 x 0.35	A6 peg tooth	for long, straight cuts, wood, wood-like materials, plastics	BS 5370, BS 5378	627643000*
2,225 x 3 x 0.65	A2 helical tooth	Wood, plastics, especially for curved cuts, for circular cuts with fine sawing equipment	BAS 380	0909060257*
2,225 x 6 x 0.36	A4 helical tooth	Wood, plastics, especially for curved cuts	BAS 380	0909060265*
2,225 x 9 x 0.36	A6 peg tooth	Wood, plastics	BAS 380	0909060273*
2,225 x 13 x 0.36	A6 peg tooth	Wood, plastics, for straight and clean cuts	BAS 380	0909060281*
2,230 x 3.5 x 0.65	A2 helical tooth	for curved cuts (curves), wood, wood-like materials, plastics	Bs 0633	630852000*
2,230 x 6 x 0.65	A4 helical tooth	for long, straight cuts, for curved cuts with larger radius, wood, wood-like materials, plastics	Bs 0633	630850000*
2,230 x 12.5 x 0.65	A6 peg tooth	for long, straight cuts, wood, wood-like materials, plastics	Bs 0633	630851000*
2,230 x 15 x 0.8	A6 peg tooth	for long, straight cuts, wood, wood-like materials, plastics	Bs 0633	630855000*
2,240 x 6 x 0.5	A4 helical tooth	Wood, plastics, especially for curved cuts	BAS 317 Precision	0909029252*
2,240 x 12 x 0.5	A6 peg tooth	Wood, plastics	BAS 317 Precision	0909029244*
2,240 x 15 x 0.5	A6 peg tooth	Wood, plastics, for straight and clean cuts	BAS 317 Precision	0909029260*
2,240 x 15 x 0.5	A2 rake tooth	Wood, plastics, aluminium	BAS 317 Precision	0909029279*
3,380 x 6 x 0.5	A4 helical tooth	Wood, plastics, especially for curved cuts	BAS 505 G, BAS 505 Precision	0909029180*
3,380 x 15 x 0.5	A6 peg tooth	Wood, plastics	BAS 505 G, BAS 505 Precision	0909029171*
3,380 x 25 x 0.5	A6 peg tooth	Wood, plastics, for straight and clean cuts	BAS 505 G, BAS 505 Precision	0909000416*
3,380 x 25 x 0.5	A18 peg tooth	Wood, firewood	BAS 505 G, BAS 505 Precision	0909000424*
3,380 x 15 x 0.5	A2 rake tooth	Wood, plastics	BAS 505 G, BAS 505 Precision	0909029210*

Band saw blades for metal



- Carbon steel with induction hardened teeth
- Very economical due to its long useable working life

Dimensions mm	Tooth pitch	Material suitability	Suitable for	Order no.
835 x 13 x 0.5	14 TPI	metal, profiles, plastics, foams	MBS 18 LTX 2.5	626427000
835 x 13 x 0.5	18 TPI	metal, profiles, plastics, foams	MBS 18 LTX 2.5	626428000
835 x 13 x 0.5	14/18 TPI	metal, profiles, plastics, foams	MBS 18 LTX 2.5	626429000
1,067 x 5 x 0.65	A2 rake tooth	NF metals, plastics, aluminium, wood	BS 150 E up to 1998	0909052939*
1,505 x 12 x 0.36	A2 rake tooth	NF metals, plastics, wood	BS 230 up to 2001	0909040841*
1,712 x 12 x 0.36	A2 rake tooth	NF metals, plastics, aluminium, wood	BAS 260 Swift	0909057191*
1,810 x 6 x 0.35	24 TPI	for straight and clean cuts, aluminium, aluminium profiles, NF metals	BS 5370, BS 5378	627644000*
2,230 x 3 x 0.65	18 TPI	profiles, sheet steel	Bs 0633	630853000*
2,230 x 10 x 0.65	4 TPI	aluminium, NF metals	Bs 0633	630854000*
2,230 x 13 x 0.65	14 TPI	Metal	Bs 0633	630858000*
3,380 x 13 x 0.65	14 TPI	NF metals coated materials, plastics	BAS 505 G	0909029228*

Machine stand



- Machine stand UMS**
- For ideal working height and stability
  - Can be folded up compactly
  - Compensation in height with adjustable stand
  - Ready mounted
- Height of work bench: 83 cm  
Weight: 12 kg  
Maximum weight load: 250 kg  
Support surface 57 x 60 cm  
suitable for: KS 216 M Lasercut, KGS 216 M, KGS 254 M, KGS 216 Plus, KGS 254 Plus / KGS 254 I Plus, KGS 315 Plus, KS 254 Plus, KS 305 Plus, KS 305 M, KGT 300, KGT 305 M, BAS 260 Swift, BAS 261 Precision, DH 330

Order no.  
631317000

Circle cutting attachments



- Circle cutting attachment**
- For circular cuts or tapered cuts (with inclined table)
  - Diameter from 120 to 280 mm
- Band saw blade 6 mm required for curve sawing  
suitable for: BAS 315 / 316, BAS 316 G, BAS 317 Precision, BAS 450, BAS 500, BAS 505 G, BAS 600, BAS 505 Precision, BAS 260 Swift

Order no.

0909031249\*



- Circle cutting attachment**
- Max. passage height:  
BAS 261 Precision: 30 mm  
BAS 318 Precision: 105 mm
- For circular cuts or tapered cuts (with inclined table)  
Band saw blade 6 mm required for curve sawing  
suitable for: BAS 261 Precision, BAS 318 Precision

631327000

Belt sanding attachment



- Belt sanding attachment**
- For regrinding surfaces and curved sawing cuts  
suitable for: BAS 318 Precision

Order no.

631333000

Cloth sanding belts



Grit	Dimensions mm	Sales unit	Suitable for	Order no.
P 80	20 x 2,205	3	BAS 380	0909060303*
P 150	20 x 2,205	3	BAS 380	0909060320*
P 80	20 x 2,240	3	BAS 315 / 316, BAS 316 G, BAS 317 Precision, BAS 318 Precision	0909030528*
P 120	20 x 2,240	3	BAS 315 / 316, BAS 316 G, BAS 317 Precision, BAS 318 Precision	0909030536*
P 80	25 x 3,380	3	BAS 450, BAS 500, BAS 505 G, BAS 600, BAS 505 Precision	0909030544*
P 120	25 x 3,380	3	BAS 450, BAS 500, BAS 505 G, BAS 600, BAS 505 Precision	0909030552*

Hook and loop sanding sheets



Grit	Diameter mm	Sales unit	Suitable for	Order no.
P 60	200	5	BAS 380	0909060338*
P 80	200	5	BAS 380	0909060346*
P 100	200	5	BAS 380	0909060354*

\*Self-service packaging



Technical data	Bench Thicknesser DH 330
Dimensions L x W x H	579 x 857 x 574 mm
Chip removal bench thicknesser	0 - 3 mm
Material thickness table	Cast aluminium / special steel aluminium
Thickness table L x W	840 x 330 mm
Passage height/width	152 mm/330 mm
Feed rate	7 m/min
Diameter of blade shaft	47 mm
Number of blades	2
Revolutions of blade shaft	9,800 /min
Rated input power	1,800 Watt
Weight	35 kg

Scope of delivery

Order no.	0200033000
2 integrated HSS reversible planer blades	■
Push stick	■
Extraction nozzles	■

Product advantages

- Ideal for mobile use due to low weight
- Stable gear for uniform work piece feed
- Convenient height adjustment with crank handle
- Easy setting of common passage heights using stop points
- Powerful universal motor for a strong drive and uniform planing result
- Restart protection: prevents unintentional start-up after power supply interruption
- Precise thickness adjustment for quick and exact planing
- Large feed and exit tables support the conveyance of long materials
- Planing locking mechanism prevents unintentional adjustment of the chip removal setting

System components

Accessories → 452 | Extraction systems → 453



Technical data	Planer Thicknesser HC 260 C - 2,2 WNB	Planer Thicknesser HC 260 C - 2,8 DNB
Dimensions	1,110 x 620 x 960 mm	1,110 x 620 x 960 mm
Dressing plates L x W	1,040 x 260 mm	1,040 x 260 mm
Chip removal, planing	0 - 3 mm	0 - 3 mm
Chip removal bench thicknesser	0 - 3 mm	0 - 3 mm
Material dressing plates	Cast aluminium	Cast aluminium
Material thickness table	Grey cast iron	Grey cast iron
Thickness table L x W	400 x 260 mm	400 x 260 mm
Passage height/width	160 mm/260 mm	160 mm/260 mm
Feed rate	5 m/min	5 m/min
Diameter of blade shaft	63 mm	63 mm
Number of blades	2	2
Revolutions of blade shaft	6,500 /min	6,500 /min
Rated input power	2,200 W	2,800 W
Output power	1,600 W	2,000 W
Weight	71 kg	71 kg

Scope of delivery

Order no.	0114026000	0114026100
integrated disposable reversible planer blades	■	■
short, swivelling jointing fence	■	■
Chip ejection hood	■	■
Push stick	■	■
Extraction nozzles	■	■
Transport wheels	■	■

Product advantages

- High torque three-phase motor
- Simple conversion from surface planer to bench thicknesser without tools
- Stable gear for uniform work piece feed
- Thickness table made of solid, non-abrasive grey cast iron
- Convenient height adjustment with crank handle
- Planer blades with double blade for longer service life
- Jointing fence, swivelling 90°-45°
- Powerful universal motor for a strong drive and uniform planing result
- Quiet induction motor, maintenance-free and robust.
- Restart protection: prevents unintentional start-up after power supply interruption

System components

Accessories → 452 | Extraction systems → 453

Disposable reversible planer blades

- For all soft woods

Dimensions mm	Reversible planer blades	Suitable for	Sales unit	Order no.
260 x 18.6 x 1	■	HC 260 C, HC 260 M, HC 260 K	2	0911030713*
260		ADH 260	2	630468000

HSS planer blades



- For all soft woods and hard woods
- Re grindable
- 18% tungsten = increased tool life

Dimensions mm	Reversible planer blades	Suitable for	Sales unit	Order no.
260		ADH 260	2	630467000
260		ADH 1626	2	630545000
260 x 20 x 2.5		Multi 260	2	0920054030*
260 x 20 x 3		HC 260 C, HC 260 M, HC 260 K	2	0911030721*
263 x 24.5 x 3		HC 260 E / ES up to construction year 1989	2	0911030748*
304 x 25 x 3		HC 300	2	0911060167*
310		ADH 310	2	631878000
310 x 20 x 2.5		Multi 310	2	0920054048*
310 x 20 x 3		HC 333 G	2	0911053179*
310 x 30 x 3		HC 314 up to construction year 1989 99	4	0911016362*
320 x 25 x 3		HC 320 up to construction year 1989 99	3	0911014220*
334 x 16 x 2	■	DH 330 up to construction year 1989 05	2	0911062119*
332 x 12 x 1.5	■	DH 330 as of year of construction 06, DH 316	2	0911063549*
410 x 25 x 3		HC 410 G	3	0911050390*

Carbide planer blade

- For all hard woods, especially exotic woods, laminated wood, hard paper, fabric reinforced laminates
- Panel materials and plastics
- Re grindable, long tool life

Dimensions mm	Reversible planer blades	Suitable for	Sales unit	Order no.
260 x 20 x 3		HC 260 C, HC 260 M, HC 260 K	2	0911030730*

Planer blade and retaining strip conversion set

Dimensions mm	Reversible planer blades	Suitable for	Sales unit	Order no.
260		HC 260 C, HC 260 M	2	0911030845



# Vacuuming and Extraction



\*Self-service packaging

# Which all-purpose vacuum cleaner for which application?



Dust can be a hazard to the health of the user. The low-dust extraction systems from Metabo are solutions that offer optimum protection to the user. Depending on the requirements and application we recommend a vacuum cleaner that corresponds to a specific dust class.

In addition, depending on the dust type (e.g. wood dust, mineral dust) the user can select between different technologies in terms of filter cleaning: From manual to fully-automatic filter cleaning there are extraction systems available for different dust classes.

## Dust classes

Since 2005 - EN 60335-2-69, annex AA (excerpt)		Hazards / suitable for	Disposal
Dust classes	Max. transmittance		
L	 1%	<b>Keeps back 99% of:</b> <ul style="list-style-type: none"> <li>Dusts with AGW values &gt; 1 mg/m<sup>3</sup></li> <li>Slightly hazardous dust</li> </ul>	-
M	 0,1%	<b>Keeps back 99.9% of:</b> <ul style="list-style-type: none"> <li>Dusts with AGW values ≥ 0.1 mg/m<sup>3</sup></li> <li>Dust of medium hazard e.g. wood dusts (beech / oak)</li> <li>Mineral dust class M</li> </ul>	Low-dust disposal
H	 0,005%	<b>Keeps back 99.995% of:</b> <ul style="list-style-type: none"> <li>Carcinogenic dusts</li> <li>Dust containing pathogens</li> </ul>	Dust-free disposal
Additional requirement asbestos		As H with asbestos certification in accordance with TRGS 519, for Germany	Dust-free disposal

## Filter cleaning technologies

Symbol	Designation	Abbreviation	Types of extraction units	Filter cleaning technology	Function
-	-	-	AS 20 L, ASA 32 L	No filter cleaning technology	-
	PressClean	PC	ASA 25 L PC, ASA 30 L PC Inox, AS 18 L PC	Manual filter cleaning	<ul style="list-style-type: none"> <li>Switch provides manual filter cleaning of the extraction unit whilst maintaining a strong suction during breaks in removal of debris</li> </ul>
	SelfClean	SC	ASR 25 L SC, ASR 50 L SC, ASR 50 M SC	Semi-automatic filter cleaning	<ul style="list-style-type: none"> <li>Electromagnetic, semi-automatic filter cleaning during breaks</li> </ul>
	AutoCleanPlus	ACP	ASR 35 L ACP, ASR 35 M ACP, ASR 35 H ACP	Fully-automated filter cleaning	<ul style="list-style-type: none"> <li>Electromagnetic, fully automatic and demand driven MPulse filter cleaning</li> <li>Working without interruptions, particularly suited for continuous use</li> <li>If the optimum suction performance falls below a certain level, the filters are vibrated immediately</li> </ul>

# 18 V



NEW



### Technical data

### Cordless Vacuum Cleaner AS 18 L PC

Type of battery pack	Li-Ion / LiHD
Battery pack voltage	18 V
Air output max.	2,100 l/min
Vacuum	120 hPa (mbar)
Filter surface	3,600 cm <sup>2</sup>
Container volume	7.5 l
Suction hose Ø	27 mm
Hose length	3 m
Weight (including battery pack)	7.4 kg

### Scope of delivery

Order no.	602021
Suction hose (Ø 27 mm / 3.0 m)	■
Fleece filter bag	■
Suction nozzle (120 mm wide)	■
Crevice nozzle	■
Carrying strap	■
2 Li-Power battery packs (18 V/5.2 Ah)	■
Charger ASC 30-36 V »AIR COOLED«	■

Equipment variants can be found in the Metabo price list and on the internet

### Product advantages

- Light, compact cordless vacuum cleaner for mobile use for extraction and vacuuming of dust and chips
- Dry vacuum cleaner with commercial registration, certified in accordance with EU standard for L class dust
- PressClean: manual filter cleaning using strong air flow by activating the switch on the extraction unit during breaks
- With integrated blow function for blowing out, drying and drawing off exhaust air
- Eco mode for longer runtime per battery pack charge, boost mode for maximum power
- Large corner switch for easy switching On/Off also by foot operation
- Practical storage for second battery pack, charger, nozzles and hose (3 m)
- Compact MetaLoc design for stacking with the MetaLoc cases
- Robust housing with rubber protectors at the footprint for gentle, non-slip placement
- Easy transport with ergonomically-designed handle or carry strap
- Capacity display of the battery pack directly on the control panel of the vacuum cleaner

### System components

Accessories → 462

Battery packs → 72

01  
02  
03  
04  
05  
06  
07  
08  
09  
10  
11  
12  
13  
14  
15



Technical data	All-Purpose Vacuum Cleaner AS 20 L	All-purpose Vacuum Cleaner ASA 32 L
Air output max.	3,600 l/min	3,600 l/min
Vacuum	200 hPa (mbar)	200 hPa (mbar)
Filter surface	3,600 cm <sup>2</sup>	3,600 cm <sup>2</sup>
Input power max.	1,200 W	1,200 W
Container volume	20 l	32 l
Suction hose Ø	35 mm	35 mm
Hose length	1.75 m	3.2 m
Weight	5 kg	7 kg
Cable length	5 m	5 m

Scope of delivery	602012	602013
Order no.		
Suction hose (Ø 35 mm, 1.75 m)	■	
Suction hose (Ø 35 mm / 3.2 m)		■
2 Suction tubes	■	■
Cellulose pleated filter	■	■
Crevice nozzle	■	■
Pipe holder		■
Floor nozzle (260 mm wide)	■	■
Suction nozzle (120 mm wide)		■

- Product advantages**
- Compact vacuum cleaner for liquids and dry solids with commercial registration
  - Ideal for mobile use due to low weight and compact construction
  - User safety: certified in accordance with EU standard for L class dust
  - Automatic shutoff when vacuuming liquids once the maximum fill level is reached
  - Cable winding mechanism
  - Practical accessory case and storage area
- For extraction from power tools and to clean construction sites, workshops etc.
  - Power socket for a power tool thus activating automatic start-up/shut-down of the vacuum cleaner

**System components**

Accessories → 462



Technical data	All-purpose Vacuum Cleaner ASA 25 L PC	All-purpose Vacuum Cleaner ASA 30 L PC Inox
Air output max.	3,600 l/min	3,600 l/min
Vacuum	210 hPa (mbar)	210 hPa (mbar)
Filter surface	3,000 cm <sup>2</sup>	3,000 cm <sup>2</sup>
Input power max.	1,250 W	1,250 W
Container volume	25 l	30 l
Suction hose Ø	32 mm	32 mm
Hose length	3.5 m	3.5 m
Weight	8.3 kg	9.6 kg
Cable length	7.5 m	7.5 m

Scope of delivery	602014	602015
Order no.		
Suction hose (Ø 32 mm / 3.5 m)	■	■
Handle adapter	■	■
2 Aluminium suction tubes	■	
2 Suction tubes (chrome-plated)		■
Pleated polyester filter	■	■
PE Filter bags	■	■
Fleece filter bag	■	■
Crevice nozzle	■	■
Floor nozzle (300 mm wide)	■	■
Suction nozzle (120 mm wide)	■	■
Brush nozzle	■	■
Cable/hose bracket	■	■

- Product advantages**
- Compact vacuum cleaner for liquids and dry solids with commercial registration
  - Ideal for mobile use due to low weight and compact construction
  - For extraction from power tools and to clean construction sites, workshops etc.
  - Power socket for a power tool activating automatic start-up/shut-down of the vacuum cleaner
  - PressClean: manual filter cleaning using strong air flow by activating the switch on the extraction unit during breaks
  - User safety: certified in accordance with EU standard for L class dust
  - Automatic shutoff when vacuuming liquids once the maximum fill level is reached
  - With integrated blow function for blowing out, drying and drawing off exhaust air
  - Cable and hose bracket for practical transport
  - Practical accessory case and storage area
- Container made of corrosion-proof, high-quality stainless steel

**System components**

Accessories → 462



Technical data	All-Purpose Vacuum Cleaner ASR 25 L SC	All-Purpose Vacuum Cleaner ASR 50 L SC	All-Purpose Vacuum Cleaner ASR 50 M SC
Air output max.	3,660 l/min	3,660 l/min	3,660 l/min
Vacuum	248 hPa (mbar)	248 hPa (mbar)	248 hPa (mbar)
Filter surface	8,600 cm <sup>2</sup>	8,600 cm <sup>2</sup>	8,600 cm <sup>2</sup>
Input power max.	1,400 W	1,400 W	1,400 W
Container volume	25 l	50 l	50 l
Suction hose Ø	35 mm	35 mm	35 mm
Hose length	3.2 m	3.2 m	4 m
Weight	11 kg	16 kg	16 kg
Cable length	8 m	8 m	8 m

Scope of delivery

Order no.	602024 <sup>2)</sup>	602034	602045
Suction hose (Ø 35 mm / 3.2 m)	■	■	
Antistatic suction hose (Ø 35 mm / 4 m)			■
Handle adapter	■	■	■
2 Plastic suction tubes	■	■	■
2 Polyester filter cassettes (M class)	■	■	■
PE Filter bags			■
Fleece filter bag	■	■	■
Crevice nozzle	■	■	■
Universal nozzle	■	■	■
Carrying handle		■	■

<sup>2)</sup> also available in 110 V (UK)

Product advantages

- Ideal for mobile use due to low weight and compact construction
- User safety: certified in accordance with EU standard for L class dust
- Two polyester filter cassettes with large filter area for constantly high suction capacity
- Compact vacuum cleaner for liquids and dry solids with commercial registration
- For extraction from power tools and to clean construction sites, workshops etc.
- Power socket for a power tool activating automatic start-up/shut-down of the vacuum cleaner
- SelfClean: semi-automatic filter cleaning during breaks for next use
- Automatic shutoff when vacuuming liquids once the maximum fill level is reached
- Automatic trailing mechanism for emptying the suction hose completely
- Basic antistatic equipment prevents static charge when using appropriate accessories
- Cable winding mechanism
- Practical accessory case and storage area
- Storage and transport system: coupling of MetaLoc and vacuum cleaner with the Metadepot (accessory)
- High user safety: certified in accordance with EU standard for M class dusts
- Warning signal on shortfall of the minimum volume flow to protect the user

System components

Accessories → 462



Technical data	All-Purpose Vacuum Cleaner ASR 35 L ACP	All-Purpose Vacuum Cleaner ASR 35 M ACP	All-Purpose Vacuum Cleaner ASR 35 H ACP
Air output max.	3,660 l/min	3,660 l/min	3,660 l/min
Vacuum	248 hPa (mbar)	248 hPa (mbar)	248 hPa (mbar)
Filter surface	8,600 cm <sup>2</sup>	8,600 cm <sup>2</sup>	8,600 cm <sup>2</sup>
Input power max.	1,400 W	1,400 W	1,400 W
Container volume	35 l	35 l	35 l
Suction hose Ø	35 mm	35 mm	35 mm
Hose length	3.5 m	4 m	4 m
Weight	16 kg	16 kg	16 kg
Cable length	8 m	8 m	8 m

Scope of delivery

Order no.	602057 <sup>1)</sup>	602058 <sup>2)</sup>	602059
Suction hose (Ø 35 mm / 3.2 m)	■		
Antistatic suction hose (Ø 35 mm / 4 m)		■	■
Connection bush Ø 41/48 mm		■	■
Handle adapter	■	■	■
2 Plastic suction tubes	■	■	■
2 Polyester filter cassettes (M class)	■	■	
2 HEPA polyester filter cassettes			■
PE Filter bags	■	■	■
Crevice nozzle	■	■	■
Floor nozzle (300 mm wide)		■	■
Floor nozzle (370 mm wide)	■		

<sup>1)</sup> also available in 120 V (North/Latin America)

<sup>2)</sup> also available in 110 V (UK)

Product advantages

- User safety: certified in accordance with EU standard for L class dust
- Suction power regulator for adapted suction performance
- High user safety: certified in accordance with EU standard for M class dusts
- Ideal vacuum cleaner for removal of mould and old insulation in roof and wall areas
- Maximum user safety: certified in accordance with EU standard for H class dusts
- Warning signal on shortfall of the minimum volume flow to protect the user
- Optimum suction power by preselection of the hose diameter
- Compact vacuum cleaner for liquids and dry solids with commercial registration
- Power socket for a power tool activating automatic start-up/shut-down of the vacuum cleaner
- AutoCleanPlus: saves both costs and time thanks to automatic MPulse filter cleaning during continuous use
- If the optimum suction performance falls below a certain level, the filters are vibrated immediately
- Automatic shutoff when vacuuming liquids once the maximum fill level is reached
- Automatic trailing mechanism for emptying the suction hose completely
- Basic antistatic equipment prevents static charge when using appropriate accessories

System components

Accessories → 462

Which connection option for which handheld power tool?

Metabo All-purpose Vacuum Cleaner							
	ASA 32 L ASA 25 L PC <sup>1)</sup> ASA 30 L PC Inox <sup>1)</sup> ASR 25 L SC		ASR 50 L SC ASR 50 M SC ASR 35 L, M, H ACP				
Suction hose diameter	Ø 27 mm		Ø 32 mm	Ø 35 mm			
Hose length	3.5 m	3.5 m	3.5 m	2.5 m	3.2 m	4.0 m	4.0 m
Order no.	631938000	631939000	631337000	631752000	631362000	631370000	630344000
	without adapter		with 624996000				
<b>Adapters and connectors</b>							
<b>Long-neck Sanders</b>							
LSV 5-225 Comfort, LSV 5-225	■						
<b>Cordless Circular Saw</b>							
KS 18 LTX 57	■						
<b>Circular Saws</b>							
KSE 55 Vario Plus, KS 55, KS 55 FS, KS 66, KS 66 Plus, KSE 68 Plus	■/□						
<b>Jigsaws/Cordless Jigsaw</b>							
STA 18 LTX 100, STAB 18 LTX 100, STE 140 Plus, STEB 140 Plus, STA 18 LTX 140, STEB 65 Quick, STE 100 Quick, STEB 70 Quick, STEB 80 Quick	■						
<b>Sanders</b>							
DSE 280 Intec, DSE 300 Intec				with adapter 624994000			
FMS 200 Intec, FSR 200 Intec, FSX 200 Intec	■			with adapter 626996000			
SRE 3185, SR 2185, SXE 3125, SXE 3150	■						
SXE 400	■						
SXE 425 TurboTec, SXE 450 TurboTec	■						
SXE 150-2.5 BL, SXE 150-5.0 BL	■						
SRE 4350 TurboTec, SRE 4351 TurboTec	■						
MT 18 LTX	■						
<b>Belt Sander</b>							
BAE 75	■						
<b>Cutting Systems</b>							
W 12-125 HD Set CED / W 12-125 HD Set CED Plus	■/□						
<b>Dust extraction shrouds for angle grinders</b>							
CED 125, CED 125 Plus	■/□						
Guard Ø 180 mm, Ø 230 mm	■/□						
<b>Sanding/extraction guards for angle grinders</b>							
GED 125	■/□						
<b>Routers and planers</b>							
HO 18 LTX 20-82, HO 26-82, Ho 0882, LF 724 S, OFE 738, OFE 1229 Signal	■/□						
<b>Wall Chasers</b>							
MFE 30, MFE 65, MFE 40	■						
<b>Renovation grinders and renovation milling machines</b>							
RS 14-125/17-125, WE 15-125 HD Set GED, RF 14-115, RSEV 19-125 RT, RFEV 19-125 RT	■/□						

■ Connection possible without adapter  
□ Connection possible via an optional coupling bush - large Ø 41/48 mm (order no. 630796000)

Extraction possibility when drilling

- For all drills, combination and multi hammers as well as drills and impact drills
- Vacuum cleaner adapter for extracting the drill dust directly from the drilled hole
- Auto-suction on almost all surfaces

	for drill Ø	for suction hose Ø	Order no.
DDE 14	4-14 mm	27 mm 32 mm 35 mm	630829000
DDE 72	up to 32 mm with brush rim up to 32-72 mm without brush rim	32 mm with click adapter* 35 mm with threaded adapter* *included in the scope of delivery	631343000

Which connection option for which wood processing tool?

Metabo All-purpose Vacuum Cleaner							Chip and Dust Extraction Units						
	ASA 32 L ASA 25 L PC <sup>1)</sup> ASA 30 L PC Inox <sup>1)</sup> ASR 25 L SC		ASR 50 L SC ASR 50 M SC ASR 35 L, M, H ACP					SPA 1200 SPA 1702 W SPA 2002 W SPA 2002 D					
Diameter	Ø 27 mm		Ø 32 mm	Ø 35 mm			Ø 58 mm	Ø 100 mm					
Length	3.5 m	3.5 m	3.5 m	2.5 m	3.2 m	4.0 m	3 m	2.5 m <sup>2)</sup>	5 m	10 m			
Order no.	631938000	631939000	631337000	631752000	631362000	631370000	630312000		7854112915	7854115035			
	without adapter		with suction adapter 0910059955			with transition piece 630316000	with suction adapter 0910031260	without adapter	with suction adapter Multi 0910058010	with suction adapter 0910031260	without adapter	with suction adapter Multi 0910058010	with universal adapter 0913031288
<b>Adapters and connectors</b>													
<b>Mitre Saws</b>													
KS 18 LTX 216 KGS 18 LTX 216 KS 216 M Lasercut KGS 216 M KGSV 216 M KGS 254 M KGS 305 M KS 305 M	■/□						□	□					
KS 254 Plus KS 305 Plus	■/□		■/□					■	■				
KGSV 72 Xact KGSV 72 Xact SYM	■/□						□	□					
KGS 216 Plus KGS 254 Plus KGS 254 I Plus KGS 315 Plus			■						■	■			
KGT 300	□						■	■					
KGT 305 M	■/□						□	□					
<b>Pull Saws</b>													
UK 290 UK 333 with two-point extraction 0910064371			■						■	■			
<b>Table Saws</b>													
TS 36-18 LTX BL 254 TS 36 LTX BL 254	■/□									□	□		
TS 216 TS 254	■/□									■	■		
TKHS 315 C TKHS 315 M						■			■	■			
<b>Planer Thicknessers</b>													
HC 260 C DH 330									■	■			
<b>Band Saws</b>													
BAS 261 Precision BAS 260 Swift BAS 318 Precision BAS 317 Precision BAS 505 Precision	□		■						■	■			









■ Connection possible without adapter  
□ Connection possibility via optionally available coupling bush large Ø 41/48 mm (order no. 630796000)



<sup>1)</sup> only compatible with hose 631337000

<sup>2)</sup> only available in the scope of delivery, available as spare part











Suction Hoses



	Order no.
 <p><b>Suction hose</b></p> <ul style="list-style-type: none"> <li>With bayonet fitting and rubber connector (internal Ø 30 mm, outside Ø 35 mm)</li> <li>Flexible and easy extension: extraction hose can be connected to a second one without additional connector</li> <li>Connector Ø: 58 mm</li> </ul> <p>Hose length: 3.5 m Suction hose Ø: 27 mm</p>	631938000
 <p><b>Suction hose</b></p> <ul style="list-style-type: none"> <li>Antistatic suction hose</li> <li>With bayonet fitting and rubber connector (internal Ø 30 mm, outside Ø 35 mm)</li> <li>Flexible and easy extension: extraction hose can be connected to a second one without additional connector</li> </ul> <p>Connector Ø: 58 mm / 35 mm Hose length: 3.5 m Suction hose Ø: 27 mm</p>	631939000
 <p><b>Suction hose</b></p> <ul style="list-style-type: none"> <li>With coupling bush with shunt air opening</li> <li>Standard equipment for ASA 25 L PC and ASA 30 L PC Inox</li> </ul> <p>Hose length: 3.5 m Suction hose Ø: 32 mm</p>	631337000
 <p><b>Suction hose</b></p> <ul style="list-style-type: none"> <li>With swivel joint and bayonet connector</li> <li>Standard equipment for AS 20 L</li> </ul> <p>Connector Ø: 58 mm Hose Length: 1.75 m Suction hose Ø: 35 mm</p>	631751000
 <p><b>Suction hose</b></p> <ul style="list-style-type: none"> <li>With swivel joint</li> <li>For bayonet fitting</li> </ul> <p>Connector Ø: 58 mm / 35 mm Hose Length: 2.5 m Suction hose Ø: 35 mm</p>	631752000
 <p><b>Suction hose</b></p> <ul style="list-style-type: none"> <li>With swivel joint</li> <li>Flexible and easy extension: extraction hose can be connected to a second one without additional connector</li> <li>Standard equipment for ASA 32 L, ASR 50 L SC, ASR 25 L SC</li> </ul> <p>Connector Ø: 58 mm Hose length: 3.5 m Suction hose Ø: 35 mm</p>	631362000
 <p><b>Suction hose</b></p> <ul style="list-style-type: none"> <li>When using a second suction hose, the dust extraction device can be placed at a distance of up to 8 m from the work area</li> <li>With bayonet fitting for connection to the extraction nozzle of wall chasers MFE 30, MFX 65 and MFE 65</li> </ul> <p>Connector Ø: 35/35 mm Hose Length: 4 m Suction hose Ø: 35 mm</p>	630344000
 <p><b>Suction hose</b></p> <ul style="list-style-type: none"> <li>Antistatic suction hose</li> <li>For bayonet fitting</li> <li>With swivel joint</li> <li>Flexible and easy extension: extraction hose can be connected to a second one without additional connector</li> <li>Standard equipment for ASA 50 M SC</li> </ul> <p>Connector Ø: 58 mm Hose Length: 4 m Suction hose Ø: 35 mm</p>	631370000

	Order no.
 <p><b>Suction hose</b></p> <ul style="list-style-type: none"> <li>When using a second suction hose, the dust extraction device can be placed at a distance of up to 6 m from the work area</li> </ul> <p>Connector Ø: 58 mm Hose length: 3 m Suction hose Ø: 58 mm</p>	630312000
 <p><b>Suction hose</b></p> <ul style="list-style-type: none"> <li>Standard equipment of the AS 18 L PC</li> </ul> <p>Hose length: 3 m Suction hose Ø: 27 mm</p>	630171000

Adapters











	Order no.
 <p><b>Handle adapter</b></p> <ul style="list-style-type: none"> <li>As handle, for attaching between the suction hoses and the suction pipes</li> <li>Standard equipment for ASR 2025, ASR 2050 and SHR 2050 M</li> </ul>	630317000
 <p><b>Reducing sleeve Ø 58/35 mm</b></p>	631364000
 <p><b>Adapter Ø 30/35 mm</b></p> <ul style="list-style-type: none"> <li>For connecting the suction hose with connector Ø 35 mm to an extraction nozzle Ø 30 mm</li> </ul>	624996000
 <p><b>Adapter Ø 35/58 mm</b></p> <ul style="list-style-type: none"> <li>For connecting the suction hoses with connection Ø 35 mm to an extraction nozzle Ø 58 mm. Adapter is part of the dust extraction set 630828000.</li> </ul>	630316000*
 <p><b>Connection bush Ø 41/48 mm</b></p> <ul style="list-style-type: none"> <li>Particularly suited for coarse dirt, as well as devices with high generation of dust. Conducts electricity, length: 90 mm, inside/outside Ø: 41/48 mm</li> </ul>	630796000*
 <p><b>Coupling bush Ø 28/35 mm</b></p> <ul style="list-style-type: none"> <li>Universal connection bush for most hand-held power tools. Standard connection bush of the Metabo suction hoses.</li> <li>Conducts electricity; with non-slip internal corrugation; inside/outside Ø: 28/ 35 mm</li> </ul>	630798000
 <p><b>Bayonet connector</b></p> <ul style="list-style-type: none"> <li>For bayonet fitting of suction hoses with Ø 35 mm connector (without bayonet fitting connector) in electrical tools with Ø 35 mm extraction nozzle</li> </ul>	630898000*
 <p><b>Connecting sleeve Ø 58 mm</b></p> <ul style="list-style-type: none"> <li>For joining two suction hoses with connector Ø 58 mm</li> </ul>	631365000
 <p><b>Y-piece</b></p> <p>With Ø 58 mm connector and two Ø 58 mm openings for use in the Metabo all-purpose vacuum cleaners and the special purpose vacuum cleaner</p>	630897000*

Suction Tubes







	Diameter mm	Length m	Type	Sales unit	Order no.
	35	0.4	Plastic	2	630314000
	58	0.4	Plastic	2	630867000
	35	0.4	Chromium-plated	2	631363000

\*Self-service packaging

Nozzles



	Order no.
 <p><b>Suction nozzle</b>                      ■ Standard equipment for ASA 1202 and AS 18 L PC                      Width: 120 mm</p>	630320000*
 <p><b>Universal nozzle</b>                      ■ Reversible                      Width: 300 mm</p>	630322000
 <p><b>Floor nozzle</b>                      ■ Also suitable for vacuuming liquids                      ■ With brush head and rubber head                      Width: 370 mm</p>	630329000
 <p><b>Floor nozzle</b>                      ■ Metal version                      Width: 450 mm</p>	631940000
 <p><b>Floor nozzle</b>                      Width: 360 mm</p>	630868000
 <p><b>Set of floor nozzles</b>                      ■ Set made up of: Nozzle body, floor insert and insert for wet vacuuming                      Width: 370 mm</p>	630321000
 <p><b>Multi-purpose nozzle</b>                      ■ With 3 inserts for vacuuming carpets, flat surfaces and for vacuuming liquids                      Width: 270 mm</p>	630328000
 <p><b>Universal brush</b>                      ■ Suitable for all surfaces; Easy application thanks to handle                      Width: 40 mm                      Length: 120 mm</p>	630244000
 <p><b>Upholstery brush</b>                      ■ With swivel joint                      Width: 40 mm                      Length: 60 mm</p>	630245000*
 <p><b>Crevice nozzle</b>                      ■ Standard equipment for AS 1200, ASA 1202, ASR 2025, ASR 2050, SHR 2050 M and AS 18 L PC                      Length: 200 mm</p>	630323000*
 <p><b>Rubber nozzle</b>                      ■ tapering from 28 to 38 mm                      Length: 200 mm</p>	630324000*

Which filter bags/filter cassettes fit which extraction unit?

Filter bags/filter cassettes				Order no.	AS 18 L PC	AS 20 L AS 1200 ASA 1201	ASA 32 L ASA 1202	ASA 25 L PC ASA 30 L PC Inox	ASR 25 L SC ASR 2025 ASA 2025	ASR 50 L SC ASR 2050 SHR 2050 M	ASR 50 M SC	ASR 35 L M ACP	ASR 35 H ACP	
Paper filter bag		5 pcs. 20 l	631754000		■									01
		5 pcs. 25 l	631935000					■						02
		5 pcs. 32 l	631757000			■								03
		5 pcs. 50 l	631936000						■	■				04
PE disposal bag		5 pcs. 35/50 l	630325000								■	■	■	05
		5 pcs. 25/30 l	630298000					■						06
Fleece filter bag		5 pcs. 25/35 l	630343000					■				■		07
		5 pcs. 45/50 l	630359000						■	■				08
		5 pcs. 25/30 l	630296000					■						09
Pleated filter		5 pcs. 7.5 l	630173000	■										10
		1 pcs. Polyester	631753000		■	■								11
		1 pcs. Polyester	630299000					■						12
Filter cassettes		1 pcs. Polyester HEPA	630175000	■										13
		1 pcs. Polyester	630172000	■										14
Filter cassettes		2 pcs. Cellulose	631933000					■	■	■	■			15
		2 pcs. Polyester	631934000					■	■	■	■			
		2 pcs. Polyester nano-coated	631894000					■	■	■	■			
		2 pcs. Polyester H/ HEPA	630326000											■













\*Self-service packaging

Filter Bags

PE disposal bags	
	<ul style="list-style-type: none"> <li>20 times the volume of paper filter bags</li> <li>No clogging with fine dust (especially quartz and plaster dust)</li> <li>Meet the requirements for M and H class vacuums</li> <li>Clean, simple and fast removal and disposal</li> <li>Well suited for applications where large amounts of fine dust are generated (e.g. removal of plaster from surfaces, grinding and removal of screed etc.)</li> <li>Ideal when using machines for processing concrete and masonry, such as: renovation milling machines, renovation grinder, long-neck sanders, wall chasers etc.</li> </ul>
	<b>Order no.</b>
<b>PE disposal bag - 25/30 l</b> suitable for: ASA 25 L PC, ASA 30 L PC Inox Sales unit: 5	<b>630298000*</b>
<b>PE disposal bag - 35/50 l</b> suitable for: ASR 35 L AutoClean, ASR 35 M AutoClean, ASR 50 M SC Sales unit: 5	<b>630325000*</b>
Fleece filter bags	
	<ul style="list-style-type: none"> <li>Fleece filter bags are better and easy to open out than paper ones</li> <li>Improved mechanical stability</li> <li>Well suited for applications where small amounts of fine dust are generated (e.g. grinding and removal of paint and lacquer coatings or short drilling jobs with small diameters)</li> <li>Ideal for use with wood processing machines, such as routers, planer thicknessers, small random orbital sanders and orbital sanders etc.</li> </ul>
	<b>Order no.</b>
<b>Fleece filter bag - 7.5 l</b> suitable for: AS 18 L PC Sales unit: 5	<b>630173000*</b>
<b>Fleece filter bag - 25/30 l</b> suitable for: ASA 25 L PC, ASA 30 L PC Inox Sales unit: 5	<b>630296000*</b>
<b>Fleece filter bags – 25/35 l</b> Suitable for all all-purpose and special suction units with a maximum container volume of 25/35 l suitable for: ASR 35 L AutoClean, ASR 35 M AutoClean, ASR 25 L SC Sales unit: 5	<b>630343000*</b>
<b>Fleece filter bags – 45/50 l</b> suitable for: ASR 50 L SC, ASR 50 M SC Sales unit: 5	<b>630359000*</b>
Paper filter bags	
	<ul style="list-style-type: none"> <li>Double-layer</li> </ul>
	<b>Order no.</b>
<b>Paper filter bag, 20 litres</b> suitable for: AS 1200, ASA 1201, AS 20 L Sales unit: 5	<b>631754000*</b>
<b>Paper filter bag, 50 litres</b> suitable for: ASA 9050, ASR 1250, SHO 1150 Sales unit: 5	<b>631349000*</b>
<b>Paper filter bag, 25 litres</b> suitable for: ASA 2025, ASR 2025, ASR 25 L SC Sales unit: 5	<b>631935000*</b>
<b>Paper filter bag, 50 litres</b> suitable for: ASR 2050, SHR 2050 M, ASR 50 L SC, ASR 50 M SC Sales unit: 5	<b>631936000*</b>
<b>Paper filter bag, 32 litres</b> suitable for: ASA 1202, ASA 32 L Sales unit: 5	<b>631757000*</b>
<b>Paper filter bag, 27 litres</b> suitable for: ASA 9011 Sales unit: 5	<b>631348000*</b>

\*Self-service packaging

Additional Accessories for All-purpose Vacuum Cleaners

		Order no.
	<b>Paper pre-filter</b> <ul style="list-style-type: none"> <li>Prevents the pleated filter from becoming clogged with dirt and dust</li> <li>suitable for: ASA 9050, ASR 1250</li> <li>Sales unit: 5</li> </ul>	631345000*
	<b>Polyester pre-filter</b> <ul style="list-style-type: none"> <li>Prevents the pleated filter from becoming clogged with dirt and dust</li> <li>suitable for: AS 1200, ASA 1201, ASA 1202, AS 20 L, ASA 32 L</li> <li>Sales unit: 1</li> </ul>	631967000*
	<b>Pleated filter</b> <ul style="list-style-type: none"> <li>Corresponds to dust class L</li> <li>suitable for: AS 18 L PC</li> <li>Sales unit: 1</li> </ul>	630172000*
	<b>Pleated filter</b> <ul style="list-style-type: none"> <li>Corresponds to dust class HEPA 13</li> <li>suitable for: AS 18 L PC</li> <li>Sales unit: 1</li> </ul>	630175000*
	<b>Pleated filter</b> <ul style="list-style-type: none"> <li>Corresponds to dust class M</li> <li>suitable for: ASA 25 L PC, ASA 30 L PC Inox</li> <li>Sales unit: 1</li> </ul>	630299000*
	<b>Pleated filter</b> <ul style="list-style-type: none"> <li>Corresponds to dust class M</li> <li>suitable for: AS 20 L, AS 1200, ASA 1201, ASA 32 L, ASA 1202</li> <li>Sales unit: 1</li> </ul>	631753000*
	<b>Paper filter cassettes</b> <ul style="list-style-type: none"> <li>Corresponds to dust class M</li> <li>suitable for: ASA 2025, ASR 2025, ASR 2050, SHR 2050 M, ASR 35 L AutoClean, ASR 35 M AutoClean</li> <li>Sales unit: 2</li> </ul>	631933000*
	<b>2 Polyester filter cassettes</b> <ul style="list-style-type: none"> <li>Corresponds to dust class: M</li> <li>Also suitable for absorbing graphite/toner and vacuuming liquids</li> <li>suitable for: ASA 2025, ASR 2025, ASR 2050, SHR 2050 M, ASR 35 L AutoClean, ASR 35 M AutoClean</li> <li>Sales unit: 2</li> </ul>	631934000*
	<b>2 HEPA filter cassettes</b> <ul style="list-style-type: none"> <li>Corresponds to dust class H (HEPA 14)</li> <li>HEPA = high efficiency particulate air filter</li> <li>Keeps back 99.995% of fine dusts larger than 0,3 µm</li> <li>suitable for: ASR 2025, ASR 2050, SHR 2050 M, ASR 35 L AutoClean, ASR 35 M AutoClean</li> <li>Sales unit: 2</li> </ul>	630326000*
	<b>2 Filter cassettes, polyester, nano-coated</b> <ul style="list-style-type: none"> <li>Suitable for fibrous fine dusts; e.g. when cutting and grinding Fermacell boards, gypsum plaster and MDF boards</li> <li>Larger pleat distance for better, easier cleaning of the filter</li> <li>Smooth filter material (surface nano-coated); therefore significantly higher volume flow for a longer time</li> <li>Corresponds to dust class M</li> <li>suitable for: ASR 25 L SC, ASR 50 M SC, ASR 50 L SC, ASR 35 L AutoClean, ASR 35 L AutoClean Plus, ASR 35 M AutoClean, ASR 35 M AutoClean Plus</li> <li>Sales unit: 2</li> </ul>	631894000*
	<b>Carrying handle</b> <ul style="list-style-type: none"> <li>Very light and easily mobile as a result</li> <li>Including spring cotter</li> <li>suitable for: ASR 35 L AutoClean, ASR 35 M AutoClean</li> <li>Sales unit: 1</li> </ul>	630311000
	<b>Metadepot</b> <ul style="list-style-type: none"> <li>For practical storage of pipes, cables and accessories.</li> <li>Provides the combination of Metabo all-purpose vacuum cleaners with the MetaLoc system</li> <li>suitable for: ASR 2025, ASR 2050, SHR 2050 M, ASR 25 L SC, ASR 50 L SC, ASR 50 M SC</li> <li>Sales unit: 1</li> </ul>	631937000
	<b>Trolley AS 18 L PC / MetaLoc</b> <ul style="list-style-type: none"> <li>For extra mobility for the AS 18 L PC and the MetaLocs</li> <li>For highest safety, MetaLoc and AS 18 L PC can be fixed with closures</li> <li>2 lockable castors ensure excellent mobility.</li> <li>suitable for: AS 18 L PC and MetaLoc</li> <li>Sales unit: 1</li> </ul>	630174000

NEW



Technical data	Chip and Dust Extraction Unit SPA 1200	Chip and Dust Extraction Unit SPA 1702 W
Dimensions	830 x 450 x 1,600 mm	882 x 562 x 1,671 mm
Maximum vacuum	1,600 Pa	1,730 Pa
Maximum volume flow	900 m³/h	1,010 m³/h
Filter surface	1 m²	1.1 m²
Hose connection Ø	100 mm	100 mm
Chip bag capacity	65 l	90 l
Rated input power	0.55 kW	0.75 kW
Weight	22 kg	24 kg
Cable length	3 m	-

Scope of delivery		
Order no.	601205	0130170100
Suction hose 100 x 2500 mm	■	■
Filter bag made of needle felt	■	■
Chip collection bag	■	■

- Product advantages**
- Integrated grounding as protection from electrostatic charge
  - Raw air extraction device for (semi) stationary wood processing machines (observe country-specific regulations!)
  - Significantly reduces dust content
  - Filter material of dust class L
  - Quick change of the application location by means of wheeled unit and simple connection
  - Stable stand with supported chip bag
  - Comprehensive range of accessories: automatic switch-on devices, filter cartridges, hoses and adapters

**System components**

Accessories → 470



Technical data	Chip and Dust Extraction Unit SPA 2002 W	Chip and Dust Extraction Unit SPA 2002 D
Dimensions	1,178 x 650 x 1,973 mm	1,178 x 650 x 1,973 mm
Maximum vacuum	2,124 Pa	2,124 Pa
Maximum volume flow	790 m³/h	790 m³/h
Filter surface	4.1 m²	4.1 m²
Hose connection Ø	100 mm	100 mm
Chip bag capacity	135 l	135 l
Rated input power	1.1 kW	1.5 kW
Weight	114 kg	116 kg



Scope of delivery		
Order no.	0130200100	0130200110
Suction hose 100 x 2500 mm	■	■

- Product advantages**
- High torque three-phase motor
  - Raw air extraction device, meets the purity and safety requirements of the regulation GS-HO-07
  - User safety thanks to permanent compliance with only 0.1 mg/m³ residual dust content (dust class M)
  - Released for commercial use
  - For connection to stationary and semi-stationary woodworking machines
  - Optimum volume flow and vacuum for maximum performance
  - Cyclone technology goes easy on the filter for extended maintenance intervals
  - Manometer for monitoring the minimum air volume flow
  - Easy and effective filter cleaning, even during operation
  - Stable stand with supported chip bag
  - Wheeled collection container for easy transport of the chips
  - Release lever for quick changing of dust sack
  - Window for checking fill level of bin
  - Comprehensive range of accessories: automatic switch-on devices, filter cartridges, hoses and adapters

**System components**

Accessories → 470

01  
02  
03  
04  
05  
06  
07  
08  
09  
10  
11  
12  
13  
14  
15

Auto switch-on devices		Order no.
<ul style="list-style-type: none"> <li>Automatic power on/off of the chip and dust extraction unit after the wood processing machine has been switched on or off</li> <li>Time-delayed: in this way, even residual dust is extracted</li> </ul>		
	<b>Auto switch-on device ALV 1</b> 2 Alternating current sockets ( 230 V ) 200 VA - 2300 VA IP 44 340 g Mains Voltage 220-240 V Mains frequency: 50 - 60 Hz Dimensions: 158 x 116 x 60 mm suitable for: SPA 1000, SPA 1100, SPA 1701 W, SPA 2001 W, SPA 1101, SPA 1702 W, SPA 2002 W, SPA 1200	0913014626
	<b>Auto switch-on device ALV 10</b> 2 Alternating current sockets ( 230 V ) 2 Three-phase sockets ( 400 V ) Mains connection with phase inverter Mains voltage: 220-240 V / 380-400 V 4 Screwing options M5 x 7.2 mm IP 44 Mains voltage: 230/400 V Mains frequency: 50 - 60 Hz Fuse protection: T 16 A Dimensions: 235 x 106 x 155 mm suitable for: SPA 1000, SPA 1700 D, SPA 2000 D, SPA 1100, SPA 1701 W, SPA 2001 W, SPA 2001 D, SPA 1101, SPA 1702 W, SPA 2002 W, SPA 2002 D, SPA 1200	0913014634





Filter cartridges		Order no.
	<ul style="list-style-type: none"> <li>Filters the finest dust particles</li> </ul>	
<b>Filter cartridge</b> Filter area 5.2 m <sup>2</sup> Ø 327 x 857 mm Corresponds to dust class M suitable for: SPA 1000, SPA 1100, SPA 1101		0913005058
<b>Filter cartridge</b> Filter area 5.2 m <sup>2</sup> Ø 327 x 857 mm Corresponds to dust class M suitable for: SPA 1700 D, SPA 1701 W, SPA 1702 W, SPA 1200		0920016529
<b>Filter cartridge</b> Assortment pack of pocket filters with mounted filter plate (as spare) Corresponds to dust class M suitable for: SPA 2001 W, SPA 2001 D, SPA 2002 W, SPA 2002 D		0913059441





Chip collection bags		Order no.
		
<b>Chip collection bag</b> 480 x 806 mm, 120 µ , transparent suitable for: SPA 1000, SPA 1100, SPA 1101 Sales unit: 1		0913007123
<b>Chip collection bag</b> 613 x 1180 mm, 120 µ , transparent suitable for: SPA 1700 D, SPA 1701 W, SPA 1702 W, SPA 1200 Sales unit: 1		0913017617
<b>Chip collection bag</b> 785 x 1290 mm, 150 µ , transparent suitable for: SPA 2000 D Sales unit: 1		0913013581

		Order no.
<b>Chip collection bag</b> 854 x 1320 mm, 200 µ , transparent suitable for: SPA 2001 W, SPA 2001 D, SPA 2002 D, SPA 2002 W Sales unit: 1		0913059433
<b>Dust bags</b> Chip bags as replacement for the EOB 9228 suitable for: AG 2416 Sales unit: 10		630896000
<b>Dust bags</b> particularly tear-resistant and robust suitable for: AG 2417 Sales unit: 5		631756000

Suction hoses, Ø 100 mm		
		
Length m	Diameter mm	Order no.
5	100	7854112915
10	100	7854115035
2.5	100	630895000

Hose connection sets, Ø 100 mm		Order no.
	<ul style="list-style-type: none"> <li>For the length extension of the standard hose of the chip and dust extraction units</li> <li>Including adapter and transition ring</li> </ul>	
<b>Hose connection set</b> Length: 2.5 m suitable for: SPA 1000, SPA 1100, SPA 1101, SPA 1700 D, SPA 1701 W, SPA 1702 W, SPA 1200		0913010779
<b>Hose connection set</b> Length: 2 m Low flammability with inserted earth cable suitable for: SPA 2000 D, SPA 2001 W, SPA 2001 D, SPA 2002 D, SPA 2002 W		0913013565

Suction adapters		Order no.
	<b>Suction adapter KGS</b> For connecting the crosscut and mitre saws to the Metabo all-purpose vacuum cleaner suitable for: KGS 255, KGS 301, KGS 303, KGS 305, KGT 300	0910059955*
	<b>Suction adapter Multi</b> For the connection of crosscut and mitre saws and mobile table saws For KGS 303 only with chip and dust extraction unit order no. 0910057561 suitable for: SPA 1000, SPA 1100, SPA 1101, SPA 1700 D, SPA 1701 W, SPA 1702 W, SPA 2000 D, SPA 2001 D, SPA 2001 W, SPA 2002 D, SPA 2002 W, SPA 1200	0910058010*
	<b>Suction adapter</b> For the connection of wet/dry vacuum cleaners to the wood processing machines suitable for: SPA 1000, SPA 1100, SPA 1101, SPA 1700 D, SPA 1701 W, SPA 1702 W, SPA 2000 D, SPA 2001 D, SPA 2001 W, SPA 2002 D, SPA 2002 W, SPA 1200	0910031260*
	<b>Universal adapter</b> As a coupling for transition ring or extraction nozzle DH 330 As a hose connection for the cleaning nozzle suitable for: SPA 1000, SPA 1100, SPA 1101, SPA 1700 D, SPA 1701 W, SPA 1702 W, SPA 2000 D, SPA 2001 D, SPA 2001 W, SPA 2002 D, SPA 2002 W, SPA 1200	0913031288

Diversions		
		Order no.
 <p>Ø 99 mm</p>	<p><b>Diversion</b> For connecting 2 hoses to the chip and dust extraction unit suitable for: SPA 1000, SPA 1100, SPA 1101, SPA 1700 D, SPA 1701 W, SPA 1702 W, SPA 2000 D, SPA 2001 D, SPA 2001 W, SPA 2002 D, SPA 2002 W, SPA 1200</p>	0913031296
Nozzles		
		Order no.
 <p>Ø 99 mm</p>	<p><b>Cleaning nozzle</b> For cleaning floors and machines suitable for: SPA 1000, SPA 1100, SPA 1101, SPA 1700 D, SPA 1701 W, SPA 1702 W, SPA 2000 D, SPA 2001 D, SPA 2001 W, SPA 2002 D, SPA 2002 W, SPA 1200</p>	0913031270
Transition rings		
		Order no.
 <p>Ø 99 mm Ø 100 mm</p>	<p><b>Transition ring</b> As a coupling for the universal adapter and for the diversion Supplied as standard with all chip and dust extraction units suitable for: SPA 1000, SPA 1100, SPA 1101, SPA 1700 D, SPA 1701 W, SPA 1702 W, SPA 2000 D, SPA 2001 D, SPA 2001 W, SPA 2002 D, SPA 2002 W, SPA 1200</p>	0913031300*
 <p>Ø 58 mm Ø 100 mm</p>	<p><b>Reducing sleeve</b> Required for connecting the dust extractor to the Magnum TK 1066 and TKU 225 machines</p>	630841000*

\*Self-service packaging



## Other Power Tools



Technical data	Hot Air Gun H 16-500	Hot Air Gun HE 20-600	Hot Air Gun HE 23-650 Control
Air volume	240 / 450 l/min	150 / 300 / 500 l/min	150 - 250 / 150 - 500 / 500 l/min
Number of air volume levels	2	3	infinitely variable
Air temperature	300 / 500 °C	50 / 50 - 600 °C	50 / 50 - 650 °C
Number of air temperature levels	2	infinitely variable	infinitely variable
Rated input power	1,600 W	2,000 W	2,300 W
Weight (without mains cable)	0.6 kg	0.7 kg	0.9 kg
Cable length	2.2 m	2.2 m	4 m









Order no.	601650 <sup>1)</sup>	602060 <sup>1)</sup>	602365 <sup>1)</sup>
-----------	----------------------	----------------------	----------------------

<sup>1)</sup> also available in 120 V (North/Latin America)

**Product advantages**

- Quick and easy temperature setting via thumbwheel control
- Particularly suited for temperature-sensitive materials thanks to precise control of air volume and temperature
- Efficient working with four preset, adjustable programmes
- Wide range of uses: removal of varnish, shaping, crimping, welding and much more
- High-quality ceramic heating, powerful motor and optimum device cooling for long service life
- Ergonomic design including handle with non-slip soft-grip surface provides comfortable handling
- Safe stationary application due to large non-slip stand surface

**Nozzles**

	Order no.
 <p><b>Wide jet nozzle, 50 mm</b>                      ■ For drying and for removing paint                      suitable for H 16-500, HE 20-600, HE 23-650 Control, H 1600, HE 2000, HE 2300 Control</p>	630001000*
 <p><b>Wide jet nozzle, 75 mm</b>                      ■ Stripping old paint from larger surfaces                      suitable for H 16-500, HE 20-600, HE 23-650 Control, H 1600, HE 2000, HE 2300 Control</p>	630002000*
 <p><b>Deflector nozzle, 75 mm</b>                      ■ For removing old paint on window frames, for waxing and de-waxing skis                      suitable for H 16-500, HE 20-600, HE 23-650 Control, H 1600, HE 2000, HE 2300 Control</p>	630003000*
 <p><b>Wrap around nozzle</b>                      ■ For warming plastic tubes etc. prior to bending and shaping; shrinking on shrink-fit plastic sleeves, (e.g. on cable ends)                      suitable for H 16-500, HE 20-600, HE 23-650 Control, H 1600, HE 2000, HE 2300 Control</p>	630004000*
 <p><b>Reducing nozzle, 20 mm</b>                      ■ For spot-heating e.g. soldering and welding                      suitable for H 16-500, HE 20-600, HE 23-650 Control, H 1600, HE 2000, HE 2300 Control</p>	6300022000*
 <p><b>Reducing nozzle 9 mm</b>                      ■ For attaching the slit nozzle 630006000 and the welding nozzle 630007000. Also suitable for spot-heating, (e.g. soldering and welding)                      ■ For hot air guns with electronics only                      suitable for HE 20-600, HE 23-650 Control, HE 2000, HE 2300 Control</p>	630005000*
 <p><b>Slit nozzle</b>                      ■ For overlap-welding of PVC tarpaulins and sheeting                      ■ The reducing nozzle 630005000 is required to fit the nozzle                      ■ For hot air guns with electronics only                      suitable for HE 20-600, HE 23-650 Control, HE 2000, HE 2300 Control</p>	630006000*
 <p><b>Welding nozzle</b>                      ■ For working with plastic welding wire (up to diameter 5 mm!)                      ■ The reducing nozzle 630005000 is required to fit the welding nozzle.                      ■ For hot air guns with electronics only                      suitable for HE 20-600, HE 23-650 Control, HE 2000, HE 2300 Control</p>	630007000*

\*Self-service packaging

**System components**

Accessories → 475



Technical data	Staplers Ta E 2019	Stapler Ta E 3030	Stapler Ta M 3034
Maximum pulse string	20 /min	20 /min	20 /min
Length staples (4 mm wide)	12 - 18 mm	18 - 30 mm	18 - 30 mm
Length staples (10 mm wide)	8 - 18 mm	-	-
Length flat wire staples, (10 mm wide)	8 - 14 mm	-	-
Length nails	19 mm	16 - 30 mm	16 - 30 mm
Weight (without mains cable)	1.4 kg	1.8 kg	1.8 kg
Cable length	2.6 m	2.6 m	4 m

Scope of delivery

Order no.	602019	603030	603034
Universal magazine for all commercial staples and nails	■		
Magazine for 4 mm wide (up to 30 mm long) staples and 16-30 mm long nails		■	■
3 front plates	■		
Rubber protective shoe		■	■

Product advantages

- Also suitable for handling flat wire staples
- Reshaping feature for incompletely driven in fasteners
- Reshaping feature for incompletely driven in fasteners
- Rubber protective shoe to prevent pressure marks
- Complete driving in of fasteners by virtue of electronically controlled multiple impact device
- Rubber protective shoe to prevent pressure marks
- For processing staples, nails, shaped wood claws and groove clutches
- Impact power control for setting the impact depth
- Tappet with nut for specific placing of stapler
- Protection against unintentional trigger use

System components

Accessories → 477

Staples type 4, 4 mm wide



■ Narrow crown staples to fix panels and wood profiles

Width mm	Length mm	Stainless	Suitable for	Sales unit	Order no.
4	12		Ta E 2019	2,000	630901000*
4	15		Ta E 2019	2,000	630902000*
4	18		Ta E 2019, Ta E 3030, Ta M 3034	2,000	630903000*
4	18	■	Ta E 2019, Ta E 3030, Ta M 3034	2,000	630909000*
4	23		Ta E 3030, Ta M 3034	2,000	630904000*
4	26		Ta E 3030, Ta M 3034	2,000	630905000*
4	26	■	Ta E 3030, Ta M 3034	2,000	630910000*
4	30		Ta E 3030, Ta M 3034	2,000	630906000*

Staples type 53, 10 mm wide



■ Fine wire staples to fix material and fabric

Width mm	Length mm	Suitable for	Sales unit	Order no.
10	8	Ta E 2019	1,000	630570000*
10	10	Ta E 2019	1,000	630571000*
10	12	Ta E 2019	1,000	630572000*
10	14	Ta E 2019	1,000	630573000*
10	18	Ta E 2019	1,000	630574000*

Flat wire staples type 53 F, 10 mm wide



■ Flat wire staples to fix films

Width mm	Length mm	Suitable for	Sales unit	Order no.
10	8	Ta E 2019	2,000	630576000*
10	10	Ta E 2019	2,000	630577000*
10	14	Ta E 2019	2,000	630578000*

Nails



■ Nails to fix skirtings and other wood fixtures

Length mm	Suitable for	Sales unit	Order no.
16	Ta E 3030, Ta M 3034	1,000	630592000*
19	Ta E 2019, Ta E 3030, Ta M 3034	1,000	630593000*
25	Ta E 3030, Ta M 3034	1,000	630907000*
30	Ta E 3030, Ta M 3034	1,000	630908000*

Rubber protective shoe



Rubber protective shoe  
As replacement for the staplers Ta E 3030, Ta M 3034

Order no.

631053000

\*Self-service packaging





Technical data	Glue Gun KE 3000
Glue stick Ø	11 mm
Maximum adhesive output	18 g/min
Warm up time	approx. 6 min
Processing temperature	about 200 °C
Weight (without mains cable)	0.25 kg
Cable length	1.9 m

Scope of delivery	
Order no.	618121
Hot-melt type glue stick (200 mm long, transparent)	■

- Product advantages**
- Universal application for hot gluing of wood, plastic, cardboard, glass ceramic, stone, textile, cork, leather, metal etc.
  - Also suitable for sealing and joining and for repairs with hot-melt type adhesive
  - Exact dosage by means of mechanical glue supply
  - Optimum processing of the glue by means of PTC heating elements for constant temperature
  - Strap and support surface on housing for safe stop after use
  - Clean working without dripping by means of anti-drip nozzle

**Hot-melt type glue sticks, light yellow**

- 
- For gluing wood, cardboard, leather, etc. (firm glue joints after just brief pressing time)
  - Setting time measured for a 3 mm thick bead of glue on wood at 20 °C

Colour	Open time of adhesive Seconds	Weight kg	Order no.
Light yellow	approx. 25	0.5	630887000*
Light yellow	approx. 25	20	630891000

**Hot-melt type glue sticks, transparent**

- 
- Also suitable for gluing plastics (e.g. polystyrene, polyester and polyamide), fabrics, etc. (strong, elastic glue joints)

Colour	Open time of adhesive Seconds	Weight kg	Order no.
transparent	approx. 35	0.5	630886000*
transparent	approx. 35	20	630889000

**Additional nozzles**

 <ul style="list-style-type: none"> <li>■ Consisting of threaded bush and 2 nozzles (crevice nozzle and round nozzle) for screwing into the threaded bush</li> </ul>	Order no. 630885000*
--------------------------------------------------------------------------------------------------------------------------------------------------------------------------------------------------------------------------------------------------------	-------------------------



\*Self-service packaging



# Measuring Technology

# Laser Distance Meters

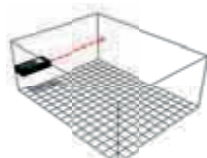
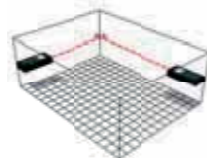
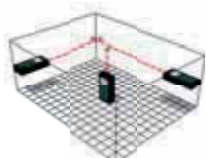
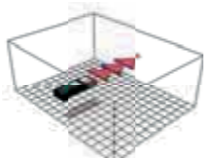
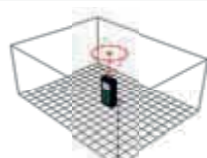
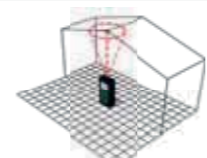
Take measurements accurate to the millimetre at the touch of a button: With the handy laser distance meters from Metabo you can take quick, precise measurements on your construction site and thus save time and money. There are different functions available for different applications. Apart from length, width and height of rooms you can also calculate sections, volumes or areas by combining the measurement data. In no time at all you will be able to determine your material requirements and create customised offers in a fast and simple manner.

Function	Applications	Function	Applications
<b>Length</b>  Determine the distance with one measurement	<ul style="list-style-type: none"> <li>Room length</li> </ul>	<b>Area</b>  Determine the area with 2 measurements	<ul style="list-style-type: none"> <li>Area calculation e.g. for paint requirements</li> <li>Drawing up of a floor plan</li> </ul>
<b>Volume</b>  Determine the volume with 3 measurements	<ul style="list-style-type: none"> <li>Layout of heating systems / air conditioning systems</li> </ul>	<b>Continuous measurement (tracking)</b>  Continuous measurements e.g. to monitor positions	<ul style="list-style-type: none"> <li>Marking of welding points</li> <li>Setting up furniture / positioning</li> </ul>
<b>Minimum tracking</b>  Continuous measurement to determine the shortest distance between 2 points	<ul style="list-style-type: none"> <li>Installation of doors / windows</li> </ul>	<b>Maximum tracking</b>  Continuous measurement to determine the longest distance between 2 points (e.g. maximum diagonal measurement)	<ul style="list-style-type: none"> <li>Verify the squareness and perpendicular characteristics of the room (space diagonal)</li> </ul>
<b>Pythagoras 1</b>  Determination of a distance (height) with 2 auxiliary measurements	<ul style="list-style-type: none"> <li>Windows</li> <li>Walls</li> </ul>	<b>Pythagoras 2</b>  Determine a distance (height/width) with 3 auxiliary measurements	<ul style="list-style-type: none"> <li>Windows</li> <li>Walls</li> <li>Houses (setting up scaffolding)</li> </ul>

### Which laser distance meter for which application?

Function	Length	Area	Volume	Continuous measurement
LD 30	■	■	■	■
LD 60	■	■	■	■

Function	Minimum tracking	Maximum tracking	Pythagoras 1	Pythagoras 2
LD 30	■	■	■	■
LD 60	■	■	■	■



### Technical data

	Laser Distance Meter LD 30	Laser Distance Meter LD 60
Laser class	2	2
Wavelength	635 nm	635 nm
Light output	< 1 mW	< 1 mW
Measurement range	0.2 - 30 m	0.05 - 60 m
Measuring accuracy	± 3 mm	± 1.5 mm
Number of measurements per battery charge	5,000	5,000
Protection type IP	IP 54	IP 40
Weight (with batteries)	0.1 kg	0.11 kg
Laser functions	Length, area, volume, continuous measurement (tracking)	Length, area, volume, continuous measurement (tracking), Pythagoras 1, Pythagoras 2, minimum tracking, maximum tracking

### Scope of delivery

Order no.	606162	606163
Belt pouch	■	■
2 Batteries AAA 1.5 V (LR03)	■	■

### Product advantages

- LC display with large digits for good legibility
- Illuminated LC display for good readability, even in poor light conditions
- Signal tone after measurement to avoid errors
- Flexible application range by switching the measurement reference (front / rear)
- Quick measurements and simple operation
- Certified according to ISO 16331-1: guaranteed measurement quality for accuracy and range
- Handy, robust device with impact-proof housing and soft grip material
- Energy-saving thanks to automatic shutdown

01  
02  
03  
04  
05  
06  
07  
08  
09  
10  
11  
12  
13  
14  
15

# Point and Line Lasers

The first step for a perfect interior development is precise measurements. With the point and line lasers from Metabo you can ensure accuracy on the construction site. The compact devices facilitate workflows, save time and costs, and increase productivity. The robust measuring instruments project horizontal and vertical lines or plumb-lines on walls, ceilings, and floors. At the touch of a button you can create for example the contours of a drywall with an almost complete 360° vertical line or facilitate the laying of tiles with up to 15 metre long right-angled laser lines on the subsurface. Our point and line lasers are the ideal robust and splash-proof aid for precise planning on construction sites.

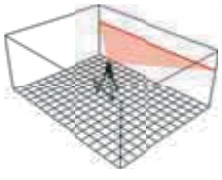
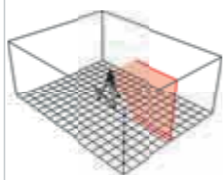
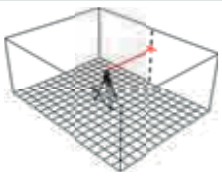
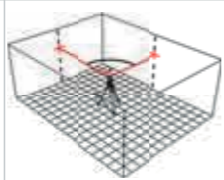
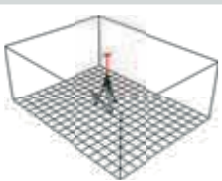
Function	Applications	Function	Applications
<b>Horizontal line</b>  <p>Laser projects a horizontal line onto the wall</p>	<b>Horizontal levelling:</b> <ul style="list-style-type: none"> <li>■ Create tiled sections</li> <li>■ Suspend ceilings</li> <li>■ Levelling window heights</li> <li>■ Installing kitchens</li> </ul>	<b>Vertical line</b>  <p>Laser projects a vertical line onto the wall, floor and ceiling</p>	<b>Vertical levelling:</b> <ul style="list-style-type: none"> <li>■ Installation of intermediate / partition walls</li> <li>■ Cable installation</li> <li>■ Wallpapering</li> </ul>
<b>Point function</b>  <p>Laser beam becomes visible as a point on a targeted area</p>	<ul style="list-style-type: none"> <li>■ Position intermediate / partition walls</li> <li>■ Setup of carports</li> <li>■ Layout work</li> </ul>	<b>Right angle (90°)</b>  <p>Laser beams are transmitted at a 90° angle</p>	<ul style="list-style-type: none"> <li>■ Create and transfer tiled sections</li> <li>■ Verification of perpendicular aspects of the room</li> <li>■ Layout creation</li> </ul>
<b>Plumb-line function</b>  <p>Laser projects a defined point from the floor to the ceiling</p>	<ul style="list-style-type: none"> <li>■ Lighting designs</li> <li>■ Install staircases</li> </ul>		



Which point and line laser for which application?

Function	Line horizontal	Vertical line	Point function	Right angle (90°)	Plumb-line function
PL 5-30			■	■	■
BLL 2-15				■	
KLL 2-20	■	■			■
MLL 3-20	■	■		■	■



**Technical data**

	Point Laser PL 5-30	Floor Line Laser BLL 2-15
Laser class	2	2
Wavelength	635 nm	635 nm
Light output	< 1 mW	< 1 mW
Laser visibility in indoor areas	30 m	15 m
Levelling accuracy	± 0.3 mm/m	-
Self-levelling range	± 4.5 °	-
Straightness of lines	-	± 0.3 mm/m
Accuracy 90° angle	± 0.2 mm/m	± 0.3 mm/m
Operating time per battery charge	20 h	20 h
Protection type IP	IP 54	IP 54
Weight (with batteries)	0.53 kg	0.34 kg
Laser functions	Point function, right angle (90°), plumb-line function	Right angle (90°)
Number of lines	-	2
Number of points	5	-
Tripod thread	1/4"	-

**Scope of delivery**

Order no.	606164	606165
Target plate	■	■
Belt pouch	■	■
Wall bracket	■	■
3 Batteries AA 1.5 V (LR6)	■	■

**Product advantages**

- Handy, robust device with impact-proof housing and soft grip material
- Self-levelling thanks to pendulum technology
- Protection and transport function: Laser in U-frame can be pivoted by 360° to protect the laser optics and pendulum
- Extendible foot for appropriate height adjustment of the laser
- Variable use of the laser: on the floor, mounted on a tripod, fastened to metal with magnet or fixed with metal lugs
- Rare earth magnet with V-groove for stable placement on metallic objects
- LED display advises low energy level in advance
- Problem solver for precise flooring jobs and layouts of any size
- Flexible work on tiles or level surfaces with dual purpose base with positioning claws
- Ideal shape for use in corners of rooms and to verify perpendicular surfaces
- No interruption due to unevenness thanks to the raised laser optics
- Precise, time-efficient working along the laser line for maximum productivity
- Vial aligned with the 90° angle for verification of the horizontal position of the laser

**System components**

Accessories → 485

01  
02  
03  
04  
05  
06  
07  
08  
09  
10  
11  
12  
13  
14  
15



Technical data	Cross Line Laser KLL 2-20	Multi-line Laser MLL 3-20
Laser class	2	2
Wavelength	635 nm	635 nm
Light output	< 1 mW	< 1 mW
Laser visibility in indoor areas	20 m	20 m
Levelling accuracy	± 0.3 mm/m	± 0.3 mm/m
Self-levelling range	± 4.5 °	± 4 °
Straightness of lines	± 0.2 mm/m	± 0.2 mm/m
Accuracy 90° angle	-	± 0.3 mm/m
Operating time per battery charge	20 h	10 h
Protection type IP	IP 54	IP 54
Weight (with batteries)	0.54 kg	0.98 kg
Laser functions	Horizontal line function, vertical line function, plumb-line function	Horizontal line function, vertical line function, right angle (90°), plumb-line function
Number of lines	2	3
Number of points	2	1
Tripod thread	1/4"	5/8"

Scope of delivery

Order no.	606166	606167
Target plate	■	■
Belt pouch	■	■
Wall bracket	■	■
Laser goggles	■	■
3 Batteries AA 1.5 V (LR6)	■	■
4 Batteries AA 1.5 V (LR6)	■	■
MetaLoc case	■	■

Product advantages

- Positioned directly against the wall, the laser generates an almost 360° vertical line
- Extendible foot for appropriate height adjustment of the laser
- 360° horizontal line for marking, alignment and levelling across the entire room
- Manual fine adjustment of the 90° angle of the vertical lines while maintaining the plumb point
- Stable aluminium upper housing to protect the horizontal laser optics
- Extendible foot for height adjustment, folding for direct placement against U profiles
- Handy, robust device with impact-proof housing and soft grip material
- Self-levelling thanks to pendulum technology
- Protection and transport function: Laser in U-frame can be pivoted by 360° to protect the laser optics and pendulum
- Variable use of the laser: on the floor, mounted on a tripod, fastened to metal with magnet or fixed with metal lugs
- Rare earth magnet with V-groove for stable placement on metallic objects
- Energy-saving power controls for each individual laser line
- LED display advises low energy level in advance

System components

Accessories → 485



Construction tripod

- Multi-purpose aluminium construction tripod
- Ideal for working on the cutting check line
- Telescopic legs with quick locking and anti-splay stop
- Geared column with metric gauge for fine adjustment of height
- Removable tripod head for convenient setup
- Good stability thanks to non-slip rubber feet
- Adapter for connecting different devices
- Easy to transport thanks to carry strap and bag

Working height: 74 cm – 192 cm  
 Working height including extension piece: up to 265 cm  
 Connecting thread: 1/4" + 5/8"  
 Weight: 5 kg

Order no.

628791000

01

02

03



Telescopic support

- Variable positioning up to 290 cm
- Clamped at the touch of a button thanks to quick feed
- Rubberised boards permit use on slanted ceilings
- Ideal for laser measurement devices or site lights

Load capacity up to 60 kg  
 Connecting thread: 1/4" + 5/8"  
 Transport height: 145 cm  
 Weight: 2.5 kg

Order no.

628790000

04

05

06



Compound slides

- Precise, very accurate adjustment of laser devices in 4 directions
- Range: 5 cm to the left/right, 10 cm forwards/backwards
- Can be fixed directly on the tripod

Connecting thread: 1/4" + 5/8"  
 Weight: 0.66 kg

Order no.

628792000

08

09

10

11

12

13

14

15

## M+ System: Machine and accessories perfectly synchronised for maximum performance.

Even during the development phase at Metabo, machines and accessories are optimally adjusted and tested to complement one another. Your added benefit: Maximum performance thanks to Metabo + System effect.



**Compressors**  
**Compressed Air Tools**  
**Compressed Air Preparation**  
**Compressed Air Distribution**

# Which compressor for which tool?

		Type																			
		Basic 250-24 W OF	Basic 250-24 W	Basic 250-50 W OF	Basic 250-50 W	Basic 280-50 W OF	Power 180-W OF	Power 250-10 W OF	Power 280-20 W OF	Power 400-20 W OF	Mega 400-50 W / D	Mega 350-50 W	Mega 350-100 W	Mega 350-100 D	Mega 350-150 D	Mega 550-90 D	Mega 700-90 D	Mega 520-200 D	Mega 580-200 D	Mega 650-270 D	
<b>Compressed air tools requiring cleaned, oiled compressed air</b>	DSSW 360 Set 1/2"			□	□	□				□	■	■	■	■	■	■	■	■	■	■	■
	DSSW 500-1/2"			□	□	□				□	■	■	■	■	■	■	■	■	■	■	■
	DSSW 930-1/2"			□	□	□				□	■	■	■	■	■	■	■	■	■	■	■
	DSSW 1690-3/4"															□	■	■	■	■	■
	DSSW 2440-1"															□	■	■	■	■	■
<b>Air Impact Wrench</b>	DSSW 360 Set 1/2"			□	□	□				□	■	■	■	■	■	■	■	■	■	■	■
	DSSW 500-1/2"			□	□	□				□	■	■	■	■	■	■	■	■	■	■	■
	DSSW 930-1/2"			□	□	□				□	■	■	■	■	■	■	■	■	■	■	■
<b>Air Ratchet Wrench</b>	DRS 68 Set 1/2"			□	□	□					■	□	□	□	□	■	■	■	■	■	■
	DRS 35-1/4"			□	□	□					■	□	□	□	□	■	■	■	■	■	■
	DRS 95-1/2"			□	□	□					■	□	□	□	□	■	■	■	■	■	■
<b>Air Screwdriver</b>	DS 14										□	□	□	□	■	■	■	■	■	■	
<b>Air Drill</b>	DB 10										□	□	□	□	■	■	■	■	■	■	
<b>Air Chipping Hammer</b>	DMH 30 Set									□	□	□	□	□	■	■	■	■	■	■	
	DMH 290 Set									□	□	□	□	□	■	■	■	■	■	■	
<b>Large Diameter Air Saw</b>	DKS 10 Set										□	□	□	□	■	■	■	■	■	■	
<b>Air Die Grinder</b>	DG 25 Set										□	□	□	□	■	■	■	■	■	■	
	DG 700														□	■	□	■	■	■	
	DG 700 L														□	■	□	■	■	■	
	DG 700-90														□	■	□	■	■	■	
<b>Air Angle Grinder</b>	DW 125														□	■	□	■	■	■	
	DW 10-125 Quick														□	■	□	■	■	■	
<b>Air Band File</b>	DBF 457														□	■	□	■	■	■	
<b>Air Disc Sander</b>	DSX 150														□	■	□	■	■	■	
<b>Air Staple Gun / Nailer</b>	DKNG 40/50	■	■	■	■	■	■	■	■	■	■	■	■	■	■	■	■	■	■	■	■
<b>Air Staple Gun</b>	DKG 80/16	■	■	■	■	■	■	■	■	■	■	■	■	■	■	■	■	■	■	■	■
	DKG 90/40	■	■	■	■	■	■	■	■	■	■	■	■	■	■	■	■	■	■	■	■
	DKG 114/65	□	□	□	■	□		□	■	■	■	■	■	■	■	■	■	■	■	■	■
<b>Air Pin Nailer</b>	DPN 25	■	■	■	■	■	■	■	■	■	■	■	■	■	■	■	■	■	■	■	■
<b>Air Brad Nailers</b>	DSN 50	■	■	■	■	■	■	■	■	■	■	■	■	■	■	■	■	■	■	■	■
<b>Air Grease Gun</b>	DFP 400	■	■	■	■	■	■	■	■	■	■	■	■	■	■	■	■	■	■	■	■

		Type																				
		Basic 250-24 W OF	Basic 250-24 W	Basic 250-50 W OF	Basic 250-50 W	Basic 280-50 W OF	Power 180-W OF	Power 250-10 W OF	Power 280-20 W OF	Power 400-20 W OF	Mega 400-50 W	Mega 400-50 D	Mega 350-50 W	Mega 350-100 W	Mega 350-100 D	Mega 350-150 D	Mega 550-90 D	Mega 700-90 D	Mega 520-200 D	Mega 580-200 D	Mega 650-270 D	
<b>Air tools requiring cleaned, oil-free, compressed air</b>	FSP 100	□	□	□	□	■		□	■	■	■	■	■	■	■	■	■	■	■	■	■	■
	FSP 600	□	□	□	□	■			■	■	■	■	■	■	■	■	■	■	■	■	■	■
	FSP 1000 S	□	□	□	□	■			■	■	■	■	■	■	■	■	■	■	■	■	■	■
	FSP 600 HVLP			□		■			■	■	■	■	■	■	■	■	■	■	■	■	■	■
	FSP 600 LVLP	□	□	□	□	■		□	■	■	■	■	■	■	■	■	■	■	■	■	■	■
	<b>Paint Spray Gun</b>	FSP 100	□	□	□	□	■		□	■	■	■	■	■	■	■	■	■	■	■	■	■
<b>Sand Blasting Gun</b>	SSP 1000																□	■	□	■	■	
	<b>Spray Gun</b>	SPP 1000	□	□	□	□	■			■	■	■	■	■	■	■	■	■	■	■	■	
<b>Combi Spray Gun</b>	UBS 1000					□			■	■	■	■	■	■	■	■	■	■	■	■	■	
<b>Air Cartridge Gun</b>	DKP 310	■	■	■	■	■	■	■	■	■	■	■	■	■	■	■	■	■	■	■	■	
<b>Tyre Inflation &amp; Pressure Gauge</b>	RF 60	■	■	■	■	■	■	■	■	■	■	■	■	■	■	■	■	■	■	■	■	
	RF 60 G	■	■	■	■	■	■	■	■	■	■	■	■	■	■	■	■	■	■	■	■	
	RF 80 G	■	■	■	■	■	■	■	■	■	■	■	■	■	■	■	■	■	■	■	■	
	RF 80 D	■	■	■	■	■	■	■	■	■	■	■	■	■	■	■	■	■	■	■	■	
<b>Blow Gun</b>	BP 10	■	■	■	■	■	■	■	■	■	■	■	■	■	■	■	■	■	■	■	■	
	BP 210	■	■	■	■	■	■	■	■	■	■	■	■	■	■	■	■	■	■	■	■	
	BP 200	■	■	■	■	■	■	■	■	■	■	■	■	■	■	■	■	■	■	■	■	
	BP 500	■	■	■	■	■	■	■	■	■	■	■	■	■	■	■	■	■	■	■	■	
<b>Blow Gun Aluminium</b>	BPA 15	■	■	■	■	■	■	■	■	■	■	■	■	■	■	■	■	■	■	■	■	
	BPA 15 S	■	■	■	■	■	■	■	■	■	■	■	■	■	■	■	■	■	■	■	■	
<b>Air Tool Set</b>	LPZ 4 Set	□	□	□	□	■			■	■	■	■	■	■	■	■	■	■	■	■	■	
	LPZ 7 Set	□	□	□	□	■			■	■	■	■	■	■	■	■	■	■	■	■	■	

■ = good suitability/ for continuous use of one tool per compressor  
 □ = limited suitability/for short use

01

02

03

04

05

06

07

08

09

10

11

12

13

14

15

# Robust, Powerful, Reliable: Metabo's Compressor Classes

We are well experienced with different compressor applications, and offer the appropriate model to suit every application. This way you can select the compressor that best suits your personal requirements! Our range spans from the light and compact basic models, through to the handy and mobile power class, and on to the extremely powerful mega compressors for more demanding applications. Your application is the decisive factor.

**Belt Drive**  
for low speeds and particularly quiet operation

**High-quality Condor pressure switch** with pressure regulator and start-up relief valve.



**Long transport handle** with integrated cable winder

**Filter pressure reducer with manometer and oil-mist lubricator** for adjustable, application-based operating pressure, and ideal air quality

**Easy access** to the condensation outlet

**Robust wheels and castors** for optimum transport and safe positioning thanks to locking brake

Mega 700-90 D



**Light and Compact: The Basic Class**  
Compact and light starter models for simple, industrial applications



**For demanding construction site use: The Power class**  
Compact and mobile piston compressors for flexible use both for interior development and on construction sites thanks to large wheels and trolley function



**Powerful and comfortable: The Mega class**  
Particularly powerful, V-belt-driven compressors for professional use in the workshop



**Technical data**

	<b>Compressor Basic 250-24 W OF</b>	<b>Compressor Basic 250-24 W</b>
Suction rate	220 l/min	200 l/min
Filling capacity	120 l/min	110 l/min
Effective delivery volume (at 80% max. pressure)	100 l/min	95 l/min
Maximum pressure	8 bar	8 bar
Rated input power	1.5 kW / 2 HP	1.5 kW / 2 HP
Maximum speed	2,850 /min	2,850 /min
Tank capacity	24 l	24 l
Sound pressure level (LpA)	82 dB(A)	81 dB(A)
Sound power level (LwA)	97 dB(A)	97 dB(A)
Dimensions	620 x 340 x 580 mm	620 x 340 x 580 mm
Weight	24 kg	27 kg
Cable length	1.5 m	1.5 m

**Scope of delivery**

Order no.	601532	601533
Universal quick-action coupling	■	■
Pull handle with rubber-grip	■	■

**Product advantages**

- Oil-free piston condenser: simple transportation and reduced service requirements
- Oil-lubricated Piston Condenser
- Powerful, robust compressor for simple, commercial use
- For single phase alternating current
- Operating pressure can be regulated according to application by means of a pressure reducer and manometer
- Convenient pressure switch for good cold starting, complete with relief valve
- Overload protection: protects the motor from overheating
- Rubberised, stable wheels for mobile use
- Additional manometer for displaying the tank pressure
- Rubber-coated handle for comfortable handling
- 10 years tank warranty against rust

**System components**

Accessories → 525

01

02

03

04

05

06

07

08

09

10

11

12

13

14

15



Technical data	Compressor Basic 250-50 W OF	Compressor Basic 250-50 W	Compressor Basic 280-50 W OF
Suction rate	220 l/min	200 l/min	280 l/min
Filling capacity	120 l/min	110 l/min	140 l/min
Effective delivery volume (at 80% max. pressure)	100 l/min	95 l/min	130 l/min
Maximum pressure	8 bar	8 bar	8 bar
Rated input power	1.5 kW / 2 HP	1.5 kW / 2 HP	1,7 kW / 2.5 HP
Maximum speed	2,850 /min	2,850 /min	2,850 /min
Tank capacity	50 l	50 l	50 l
Sound pressure level (LpA)	82 dB(A)	81 dB(A)	85 dB(A)
Sound power level (LwA)	97 dB(A)	97 dB(A)	97 dB(A)
Dimensions	780 x 400 x 625 mm	780 x 400 x 625 mm	770 x 386 x 662 mm
Weight	29 kg	32 kg	30 kg
Cable length	1.5 m	1.5 m	1.5 m

Scope of delivery

Order no.	601535	601534	601529
Universal quick-action coupling	■	■	■
Pull handle with rubber-grip	■	■	■

Product advantages

- Oil-free piston condenser: simple transportation and reduced service requirements
- No testing required before initial operation
- Oil-lubricated Piston Condenser
- Oil-free piston condenser: simple transportation and reduced service requirements
- No testing required before initial operation
- Powerful, robust compressor for simple, commercial use
- For single phase alternating current
- Operating pressure can be regulated according to application by means of a pressure reducer and manometer
- Convenient pressure switch for good cold starting, complete with relief valve
- Overload protection: protects the motor from overheating
- Rubberised, stable wheels for mobile use
- Additional manometer for displaying the tank pressure
- Rubber-coated handle for comfortable handling
- 10 years tank warranty against rust

System components

Accessories → 525



Technical data	Compressor Power 180-5 W OF	Compressor Power 250-10 W OF
Suction rate	160 l/min	220 l/min
Filling capacity	90 l/min	120 l/min
Effective delivery volume (at 80% max. pressure)	75 l/min	100 l/min
Maximum pressure	8 bar	10 bar
Rated input power	1,1, kW / 1.5 HP	1.5 kW / 2 HP
Maximum speed	2,850 /min	2,850 /min
Tank capacity	5 l	10 l
Sound pressure level (LpA)	82 dB(A)	84 dB(A)
Sound power level (LwA)	96 dB(A)	97 dB(A)
Dimensions	370 x 395 x 286 mm	470 x 480 x 348 mm
Weight	16 kg	24 kg
Cable length	4 m	4 m

Scope of delivery

Order no.	601531	601544
Universal quick-action coupling	■	
2 Universal quick-action couplings		■

Product advantages

- Crane eyelet for safe and easy transport on the construction site
- Compact and mobile piston compressor for flexible use both for interior development and on construction sites
- Portable assembly compressor – ideal for tackers and nails as well as for splitting pipes
- For single phase alternating current
- Oil-free piston condenser: simple transportation and reduced service requirements
- Instrument panel with easy to read manometer for tank- and operating pressure
- Operating pressure can be regulated according to application by means of a pressure reducer and manometer
- Fittings and control elements protected in tubular frames and clearly visible
- Cable winding mechanism
- Convenient pressure switch for good cold starting, complete with relief valve
- Overload protection: protects the motor from overheating
- Rubberised feet for optimum stability

System components

Accessories → 525

01  
02  
03  
04  
05  
06  
07  
08  
09  
10  
11  
12  
13  
14  
15





Technical data	Compressor Power 280-20 W OF	Compressor Power 400-20 W OF
Suction rate	280 l/min	330 l/min
Filling capacity	150 l/min	200 l/min
Effective delivery volume (at 80% max. pressure)	140 l/min	185 l/min
Maximum pressure	10 bar	10 bar
Rated input power	1.7 kW / 2.5 HP	2.2 kW / 3 HP
Maximum speed	2,850 /min	1,400 /min
Tank capacity	20 l	20 l
Sound pressure level (LpA)	83 dB(A)	78 dB(A)
Sound power level (LwA)	97 dB(A)	95 dB(A)
Dimensions	580 x 600 x 500 mm	580 x 600 x 500 mm
Weight	40 kg	47 kg
Cable length	4 m	4 m

Scope of delivery

Order no.	601545	601546
2 Universal quick-action couplings	■	■

Product advantages

- Particularly low-level noise and vibrations
- Designed for continuous mode with S1 motor operating mode
- Compact and mobile piston compressor for flexible use both for interior development and on construction sites
- For single phase alternating current
- Oil-free piston condenser: simple transportation and reduced service requirements
- Operating pressure can be regulated according to application by means of a pressure reducer and manometer
- Fittings and control elements protected in tubular frames and clearly visible
- Rubberised, stable wheels and pull handle for mobile use
- Cable winding mechanism
- Convenient pressure switch for good cold starting, complete with relief valve
- Overload protection: protects the motor from overheating
- Rubberised feet for optimum stability
- Attachment and transport option for Metaloc and other common storage case systems
- Crane eyelet for safe and easy transport on the construction site

System components

Accessories → 525



Technical data	Compressor Mega 400-50 W	Compressor Mega 400-50 D
Suction rate	400 l/min	400 l/min
Filling capacity	300 l/min	300 l/min
Effective delivery volume (at 80% max. pressure)	260 l/min	260 l/min
Maximum pressure	10 bar	10 bar
Rated input power	2.2 kW / 3 HP	2.2 kW / 3 HP
Maximum speed	1,050 /min	1,050 /min
Tank capacity	50 l	50 l
Sound pressure level (LpA)	86 dB(A)	86 dB(A)
Sound power level (LwA)	93 dB(A)	93 dB(A)
Dimensions	1,050 x 410 x 817 mm	1,050 x 410 x 817 mm
Weight	73 kg	73 kg
Cable length	1.5 m	1.5 m

Scope of delivery

Order no.	601536	601537
3 Universal couplings	■	■

Product advantages

- For single phase alternating current
- For three-phase current
- More powerful and robust V-belt compressor for demanding use
- Belt drive for low speeds and a particularly quiet operation
- Oil-lubricated Piston Condenser
- Operating pressure can be regulated according to application and air quality improved thanks to the filter pressure reducer with manometer and oil-mist lubricator
- Convenient pressure switch for good cold starting, complete with relief valve
- Additional manometer for displaying the tank pressure
- Overload protection: protects the motor from overheating
- Instrument panel with easy to read manometer for tank- and operating pressure
- Large, rubberised wheels for comfortable transport
- Steering castors with locking brake for high manoeuvrability
- Cable winding mechanism
- Ergonomic and long pull handle with integrated cable winder
- 10 years tank warranty against rust

System components

Accessories → 525

01  
02  
03  
04  
05  
06  
07  
08  
09  
10  
11  
12  
13  
14  
15



Technical data	Compressor Mega 350-50 W	Compressor Mega 350-100 W	Compressor Mega 350-100 D	Compressor Mega 350-150 D
Suction rate	320 l/min	320 l/min	320 l/min	320 l/min
Filling capacity	250 l/min	250 l/min	250 l/min	250 l/min
Effective delivery volume (at 80% max. pressure)	220 l/min	220 l/min	220 l/min	220 l/min
Maximum pressure	10 bar	10 bar	10 bar	10 bar
Rated input power	2.2 kW / 3 HP	2.2 kW / 3 HP	2.2 kW / 3 HP	2.2 kW / 3 HP
Maximum speed	1,350 /min	1,350 /min	1,350 /min	1,350 /min
Tank capacity	50 l	90 l	90 l	150 l
Sound pressure level (LpA)	86 dB(A)	86 dB(A)	86 dB(A)	86 dB(A)
Sound power level (LwA)	93 dB(A)	93 dB(A)	93 dB(A)	93 dB(A)
Dimensions	880 x 490 x 780 mm	1,000 x 410 x 900 mm	1,000 x 410 x 900 mm	1,380 x 420 x 950 mm
Weight	52 kg	69 kg	69 kg	85 kg
Cable length	1.5 m	1.5 m	1.5 m	1.5 m

Scope of delivery

Order no.	601589	601538	601539	601587
2 Universal couplings	■			
3 Universal couplings		■	■	■

Product advantages

- For single phase alternating current
  - Operating pressure can be regulated according to application by means of a pressure reducer and manometer
  - Rubberised feet for optimum stability
  - More powerful and robust V-belt compressor for demanding use
  - Belt drive for low speeds and a particularly quiet operation
  - Oil-lubricated Piston Condenser
  - Convenient pressure switch for good cold starting, complete with relief valve
  - Additional manometer for displaying the tank pressure
  - Overload protection: protects the motor from overheating
  - Rubberised, stable wheels and pull handle for mobile use
  - 10 years tank warranty against rust
- For single phase alternating current
  - Operating pressure can be regulated according to application by means of a filter pressure reducer with manometer
  - For three-phase alternating current
  - Operating pressure can be regulated according to application by means of a filter pressure reducer with manometer
  - For three-phase current
  - Operating pressure can be regulated according to application by means of a filter pressure reducer with manometer

System components

Accessories → 525



Technical data	Compressor Mega 550-90 D	Compressor Mega 700-90 D
Suction rate	510 l/min	650 l/min
Filling capacity	395 l/min	520 l/min
Effective delivery volume (at 80% max. pressure)	360 l/min	450 l/min
Maximum pressure	11 bar	11 bar
Rated input power	3 kW / 4 HP	4 kW / 5.5 HP
Maximum speed	1,400 /min	1,400 /min
Tank capacity	90 l	90 l
Sound pressure level (LpA)	87 dB(A)	88 dB(A)
Sound power level (LwA)	96 dB(A)	97 dB(A)
Dimensions	1,126 x 490 x 917 mm	1,188 x 520 x 1,110 mm
Weight	103 kg	119 kg
Cable length	1.5 m	1.5 m

Scope of delivery

Order no.	601540	601542
3 Universal couplings	■	■

Product advantages

- Re-cooler for less condensation water formation
- More powerful and robust V-belt compressor for demanding use
- Belt drive for low speeds and a particularly quiet operation
- Two-stage compression for particularly high performance and long service life
- For three-phase current
- Operating pressure can be regulated according to application and air quality improved thanks to the filter pressure reducer with manometer and oil-mist lubricator
- Convenient pressure switch for good cold starting, complete with relief valve
- Additional manometer for displaying the tank pressure
- Overload protection: protects the motor from overheating
- Oil-lubricated 2-cylinder piston condenser for high air supply volume
- Instrument panel with easy to read manometer for tank- and operating pressure
- Large, rubberised wheels for comfortable transport
- Steering castors with locking brake for high manoeuvrability
- Cable winding mechanism
- Ergonomic and long pull handle with integrated cable winder
- 10 years tank warranty against rust

System components

Accessories → 525

01  
02  
03  
04  
05  
06  
07  
08  
09  
10  
11  
12  
13  
14  
15



Technical data	Compressor Mega 520-200 D	Compressor Mega 580-200 D	Compressor Mega 650-270 D
Suction rate	490 l/min	510 l/min	650 l/min
Filling capacity	370 l/min	395 l/min	520 l/min
Effective delivery volume (at 80% max. pressure)	320 l/min	360 l/min	450 l/min
Maximum pressure	10 bar	11 bar	11 bar
Rated input power	3 kW / 4 HP	3 kW / 4 HP	4 kW / 5.5 HP
Maximum speed	1,300 /min	1,400 /min	1,400 /min
Tank capacity	200 l	200 l	270 l
Sound pressure level (LpA)	89 dB(A)	87 dB(A)	88 dB(A)
Sound power level (LwA)	96 dB(A)	96 dB(A)	97 dB(A)
Dimensions	1,500 x 450 x 960 mm	1,430 x 550 x 1,010 mm	1,530 x 600 x 1,160 mm
Weight	131 kg	136 kg	170 kg
Cable length	1.5 m	1.5 m	1.5 m

Scope of delivery

Order no.	601541	601588	601543
3 Universal couplings	■	■	■

Product advantages

- More powerful and robust V-belt compressor for demanding use
  - Belt drive for low speeds and a particularly quiet operation
  - For three-phase current
  - Operating pressure can be regulated according to application by means of a filter pressure reducer with manometer
  - Convenient pressure switch for good cold starting, complete with relief valve
  - Additional manometer for displaying the tank pressure
  - Overload protection: protects the motor from overheating
  - Oil-lubricated 2-cylinder piston condenser for high air supply volume
  - Rubberised, stable wheels and pull handle for mobile use
  - 10 years tank warranty against rust
- Two-stage compression for particularly high performance and long service life
- Two-stage compression for particularly high performance and long service life
  - Re-cooler for less condensation water formation

System components

Accessories → 525



Technical data	Air Impact Wrench DSSW 360 Set 1/2"
Operating pressure	6.2 bar
Air requirement	6 l/s
Square holder	1/2"
Loosening torque	360 Nm
Weight	2 kg

Scope of delivery

Order no.	604118
EURO Plug-in nipple 1/4"	■
ARO/Orion Plug-in nipple 1/4"	■
ISO Plug-in nipple 1/4"	■
Hose nozzle 10 mm and screw clamp according to ISO 11148	■
10 Socket wrenches (10, 11, 13, 14, 17, 19, 21, 22, 24, 27 mm)	■
Plastic carry case	■
Oil bottles	■
Extension	■

Product advantages

- Durable hammer impact mechanism
- For tightening car wheel bolts, for assembly work and repairs
- Robust impact wrench for changing tyres, repair and assembly work
- For different applications: 360 Nm loosening torque
- Ergonomically shaped, rubber-coated handle for comfortable and low-fatigue operation
- Exhaust guide with handle
- Change of direction of rotation clockwise/anticlockwise via control button
- Tightening torque adjustable to three levels

System components

Accessories → 502

01  
02  
03  
04  
05  
06  
07  
08  
09  
10  
11  
12  
13  
14  
15



NEW



Technical data	Air Impact Wrench DSSW 500-1/2" C	Air Impact Wrench DSSW 930-1/2"
Operating pressure	6.2 bar	6.2 bar
Air requirement	7 l/s	9 l/s
Square holder	1/2"	1/2"
Loosening torque	500 Nm	930 Nm
Weight	1.2 kg	1.8 kg

Scope of delivery	601590	601549
Order no.	601590	601549
EURO Plug-in nipple 1/4"	■	■
ARO/Orion Plug-in nipple 1/4"	■	■
ISO Plug-in nipple 1/4"	■	■
Hose nozzle 10 mm and screw clamp according to ISO 11148	■	■
Oil bottles	■	■

- Product advantages**
- Torque can be set at 4 levels for different tightening applications
  - Torque can be set at 3 levels for different tightening applications
  - For tightening car wheel bolts, for assembly work and repairs. Universal use
  - Practical and lightweight for easy operation even in difficult to reach places
  - Ergonomic composite housing: insulated non-slip and low vibration for comfortable work
  - Ergonomic forward/reverse switching with convenient one-hand operation
  - User-friendly exhaust guide through the handle avoids dust turbulence in the working area
  - Durable twin hammer

**System components**

Accessories → 502



Technical data	Air Impact Wrench DSSW 1690-3/4"	Air Impact Wrench DSSW 2440-1"
Operating pressure	6.2 bar	6.2 bar
Air requirement	10.5 l/s	13 l/s
Square holder	3/4"	1"
Loosening torque	1,690 Nm	2,440 Nm
Weight	3.5 kg	7.3 kg







Scope of delivery	601550	601551
Order no.	601550	601551
EURO Plug-in nipple 1/2"		■
ARO/Orion Plug-in nipple 1/2"		■
ISO Plug-in nipple 1/2"		■
EURO Plug-in nipple 3/8"	■	
ARO/Orion Plug-in nipple 3/8"	■	
ISO Plug-in nipple 3/8"	■	
Hose nozzle 10 mm and screw clamp according to ISO 11148	■	■
Oil bottles	■	■

- Product advantages**
- For tightening/loosening wheel bolts on cars and commercial vehicles, for assembly work and repairs. Universal use
  - Practical and lightweight for easy operation even in difficult to reach places
  - Ergonomic composite housing: insulated non-slip and low vibration for comfortable work
  - Ergonomic forward/reverse switching with convenient one-hand operation
  - User-friendly exhaust guide through the handle avoids dust turbulence in the working area
  - Torque can be set at three levels for different tightening applications
  - Durable twin hammer
  - Large front handle for an ergonomic working position
  - Extended drive stem for tightening / loosening jobs on deep centre rims
  - Robust and powerful impact wrench for heavy-duty jobs e.g. truck service

**System components**

Accessories → 502

01  
02  
03  
04  
05  
06  
07  
08  
09  
10  
11  
12  
13  
14  
15

Accessories for impact wrenches, ratchet wrenches		Order no.
	<b>Socket wrench set 1/2" (10 pieces)</b> Consisting of 10 socket wrenches (10, 11, 12, 13, 15, 17, 19, 21, 22, 24 mm)	628831000
	<b>Socket wrench set 1/2" (3 pieces)</b> Consisting of 3 socket wrenches (17, 19, 21 mm) For alloy wheel caps, long version	628833000
	<b>Socket wrench extension 1/2" impact-proof</b> Overall length 150 mm	628832000
	<b>Socket wrench set 3/4" (8 pieces)</b> Consisting of 8 socket wrenches (21, 22, 24, 26, 27, 28, 30, 32 mm)	628834000
	<b>Socket wrench set 1" (8 pieces)</b> Consisting of 8 socket wrenches (24, 27, 30, 32, 33, 34, 36, 38 mm) Deep version	628835000
	<b>Wall bracket</b> Retention force 15 kg Suitable for air tools, for 3/8", 1/2" and 3/4" air impact wrenches and accessories	628848000



**Technical data**

**Air Ratchet Wrench  
DRS 68 set 1/2"**

Operating pressure	6.2 bar
Air requirement	220 l/min
Square holder	1/2"
Speed (RPM)	175 /min
Loosening torque	68 Nm
Weight	1.2 kg

**Scope of delivery**

Order no.	604119
EURO Plug-in nipple 1/4"	■
ARO/Orion Plug-in nipple 1/4"	■
ISO Plug-in nipple 1/4"	■
7 Socket wrenches (9, 10, 11, 13, 14, 17, 19 mm)	■
Plastic carry case	■
Oil bottles	■
Extension 75 mm	■
Flexible joint	■

**Product advantages**

- Ergonomic fwd/rev switch
- Easy adjustment of direction of rotation at ratchet head
- Compact design
- For all work with screws/bolts: e.g. repairs on cars, steel construction etc.
- Ergonomic, partially rubber-coated housing: cold-insulating, non-slip and low vibration for comfortable work
- Integrated speed control
- Rotatable exhaust guide at the side of the housing.

**System components**

Accessories → 502

01

02

03

04

05

06

07

08

09

10

11

12

13

14

15



Technical data	Air Ratchet Wrench DRS 35-1/4"	Air Ratchet Wrench DRS 95-1/2"
Operating pressure	6.2 bar	6.2 bar
Air requirement	390 l/min	450 l/min
Square holder	1/4"	1/2"
Speed (RPM)	270 /min	160 /min
Loosening torque	35 Nm	95 Nm
Weight	0.53 kg	1.2 kg

Scope of delivery		
Order no.	601552	601553
EURO Plug-in nipple 1/4"	■	■
ARO/Orion Plug-in nipple 1/4"	■	■
ISO Plug-in nipple 1/4"	■	■
Oil bottles	■	■

- Product advantages**
- Practical and lightweight for easy operation even in difficult to reach places
  - Ergonomic composite housing: insulated non-slip and low vibration for comfortable work
  - User-friendly exhaust guide through the handle avoids dust turbulence in the working area
  - User-friendly, rotating exhaust guide: no dust turbulence in the working area
  - Ideally suited for all car applications
  - Universal application for all tightening & loosening tasks
  - Ergonomic fwd/rev switch
  - Rubberised handle for ergonomic and fatigue-free operation
  - High-performance planetary gear train for a long service life and optimum transmission of force

**System components**

Accessories → 502



Technical data	Air Screwdriver DS 14
Operating pressure	6.2 bar
Air requirement	340 l/min
Speed (RPM)	1,800 /min
Loosening torque	5 - 14 Nm
Weight	1.2 kg

Scope of delivery	
Order no.	604117
EURO Plug-in nipple 1/4"	■
ARO/Orion Plug-in nipple 1/4"	■
ISO Plug-in nipple 1/4"	■
Oil bottles	■

- Product advantages**
- Handy screwdriver for assembly work
  - Ergonomically shaped, rubber-coated handle for comfortable and low-fatigue operation
  - Ergonomic fwd/rev switch
  - Gun shape
  - Adjustable torque from 5 to 14 Nm
  - Bit holder for comfortable single-handed tool change
  - Exhaust guide with handle

**System components**

Accessories → 310

Technical data	Air Drill DB 10
Operating pressure	6.2 bar
Air requirement	360 l/min
Speed (RPM)	1,800 /min
Chuck capacity	3 - 10 mm
Weight	1.2 kg

Scope of delivery	
Order no.	604120
EURO Plug-in nipple 1/4"	■
ARO/Orion Plug-in nipple 1/4"	■
ISO Plug-in nipple 1/4"	■
Oil bottles	■

- Product advantages**
- Ergonomically shaped, rubber-coated handle for comfortable and low-fatigue operation
  - Quick work progress thanks to high torque of 1,800 / min
  - Ergonomic fwd/rev switch
  - Exhaust guide with handle

**System components**

Accessories → 252



Technical data	Air Chipping Hammer DMH 30 Set	Air Chipping Hammer DMH 290 Set
Operating pressure	6.2 bar	6.2 bar
Air requirement	280 l/min	330 l/min
Bit retainer	Hexagon shaft 10 mm	Hexagon shaft 10 mm
Impact rate	3,000 /min	2,900 /min
Weight	2 kg	1.7 kg

Scope of delivery		
Order no.	604115	601561
EURO Plug-in nipple 1/4"	■	■
ARO/Orion Plug-in nipple 1/4"	■	■
ISO Plug-in nipple 1/4"	■	■
Hose nozzle 10 mm and screw clamp according to ISO 11148	■	■
4 Chisels	■	■
3 Chisels	■	■
Quick clamp spring	■	■
Quick-change chuck	■	■
Plastic carry case	■	■
Oil bottles	■	■

- Product advantages**
- For processing of sheet metal and stone
  - For work in the car body area
  - Kickback damping for reduction of vibrations
  - Long piston stop with higher power transmission, effective operation and rapid work progress
  - Quick-action chuck: for quick and tool-free change of chisels
- Light, handy chipping hammer
  - Suitable for construction work on masonry, bricks, aerated concrete
  - Ideal for removing plaster and tiles and light mortising work
  - User-friendly exhaust guide through the handle avoids dust turbulence in the working area
  - Rubberised handle for ergonomic and fatigue-free operation

**System components**

Accessories → 524



Technical data	Large Diameter Air Saw DKS 10 Set
Operating pressure	6.2 bar
Air requirement	420 l/min
Cutting thickness aluminium	4 mm
Cutting thickness steel	3 mm
Stroke length	10 mm
Strokes at rated load	9,000 /min
Weight	0.65 kg

Scope of delivery	
Order no.	601560
EURO Plug-in nipple 1/4"	■
ARO/Orion Plug-in nipple 1/4"	■
ISO Plug-in nipple 1/4"	■
5 Saw blades each (18 teeth, 24 teeth, 32 teeth)	■
Hexagonal wrench	■
Plastic carry case	■
Hose nozzle 10 mm and screw clamp according to ISO 11148	■
Oil bottles	■

- Product advantages**
- Suitable for cutting metal sheets, plastics, aluminium, wood and fibre glass
  - Low vibrations for convenient continuous mode
  - Magnesium housing: particularly light and robust
  - Rubberised handle for ergonomic and fatigue-free operation
  - User-friendly exhaust guide through the handle avoids dust turbulence in the working area
  - Sound-proofed air outlet for reduced noise operation
  - Precise saw blade guide for high cutting output and clean cutting edges
  - Adjustable hoop guard: exact setting of cutting depth
  - Safety lever prevents unintentional start of the machine

**System components**

Accessories → 524



Technical data	Air Die Grinder DG 25 Set
Operating pressure	6.2 bar
Air requirement	300 l/min
Speed (RPM)	25,000 /min
Collet chuck bore	6 mm
Weight	0.43 kg

Scope of delivery	
Order no.	604116
EURO Plug-in nipple 1/4"	■
ARO/Orion Plug-in nipple 1/4"	■
ISO Plug-in nipple 1/4"	■
2 collets (3 mm, 6 mm)	■
5 mounted points each (3 mm, 6 mm)	■
2 open-jawed spanners (13 mm, 16 mm)	■
Plastic carry case	■

- Product advantages**
- For sanding/grinding, deburring, moulding/routing and engraving
  - Integrated speed control
  - Ergonomic, partially rubber-coated housing: cold-insulating, non-slip and low vibration for comfortable work
  - Safety lever for protection against accidental start up
  - Rotatable exhaust guide at the side of the housing.

**System components**

Accessories → 203



Technical data	Air Die Grinder DG 700	Air Die Grinder DG 700 L	Air Die Grinder DG 700-90
Operating pressure	6.2 bar	6.2 bar	6.2 bar
Air requirement	600 l/min	600 l/min	600 l/min
Speed (RPM)	22,000 /min	22,000 /min	12,000 /min
Collet chuck bore	6 mm	6 mm	6 mm
Weight	0.83 kg	1.3 kg	1.2 kg

Scope of delivery

Order no.	601554	601555	601592
EURO Plug-in nipple 1/4"	■	■	■
ARO/Orion Plug-in nipple 1/4"	■	■	■
ISO Plug-in nipple 1/4"	■	■	■
Collet 6 mm (industry standard)	■	■	■
Oil bottles	■	■	■

Product advantages

- Long spindle for improved access to difficult to reach places
- Angled version for working in hard to reach spaces
- Particularly powerful and robust for demanding use
- For sanding/grinding, deburring, moulding/routing and engraving
- For grinding flat and curved surfaces in a variety of different materials
- Practical and lightweight for easy operation even in difficult to reach places
- Ergonomic, insulated and lightweight housing made from impact-proof plastic
- User-friendly exhaust guide through the handle avoids dust turbulence in the working area
- Sound-proofed air outlet for reduced noise operation
- Compact dimensions for convenient one-hand operation

System components

Accessories → 203, 524



Technical data	Air Angle Grinder DW 125	Air Angle Grinder DW 10-125 Quick
Grinding wheel Ø	125 mm	125 mm
Operating pressure	6.2 bar	6.2 bar
Air requirement	500 l/min	500 l/min
No-load speed	10,000 /min	10,000 /min
Spindle threads	M 14	M 14
Weight	1.8 kg	2 kg

Scope of delivery

Order no.	601556	601591
EURO Plug-in nipple 1/4"	■	
ARO/Orion Plug-in nipple 1/4"	■	
ISO Plug-in nipple 1/4"	■	
EURO Plug-in nipple 3/8"		■
ARO/Orion Plug-in nipple 3/8"		■
ISO Plug-in nipple 3/8"		■
Hexagonal wrench	■	■
Side handle	■	
Flat-pin spanners	■	
Anti-vibration handle		■
Guard for disc	■	■
Open-jawed spanner	■	
Oil bottles	■	■

Product advantages

- Particularly powerful and robust for demanding use
- Metabo VibraTech (MVT) side handle for vibration damping to protect the user's health
- Metabo Quick for tool-free disc change by means of a quick-locking nut
- Tool-free adjustable guard; rotatable and fixable in 8 positions
- For grinding flat and curved surfaces in a variety of different materials
- Ergonomic, insulated and lightweight housing made from impact-proof plastic
- User-friendly exhaust guide through the handle avoids dust turbulence in the working area
- Sound-proofed air outlet for reduced noise operation
- Safety lever prevents unintentional start of the machine
- For use with roughing and cutting discs Ø 125 mm
- Numerous grinding wheels and cutting discs are available in the Metabo range

System components

Accessories → 130





Technical data	Air Band File DBF 457
Operating pressure	6.2 bar
Air requirement	400 l/min
Grinding belt width	13 mm
Grinding belt length	457 mm
Belt speed in idle	20 m/s
Useful length of sanding belt arm	90 mm
Weight	1.5 kg

**Scope of delivery**

Order no.	601559
EURO Plug-in nipple 1/4"	■
ARO/Orion Plug-in nipple 1/4"	■
ISO Plug-in nipple 1/4"	■
Sanding belt (13 x 457 mm; P120)	■
Fleece band (13 x 457 mm; medium)	■
Hexagonal wrench	■
Oil bottles	■

**Product advantages**

- Powerful, compact band file for grinding, satin-finish and deburring in difficult to reach places
- Tool-less sanding belt change and automatic belt tensioning
- Grinding attachment can be swivelled through 360° for perfect adaptation to any working position
- User-friendly exhaust guide through the handle avoids dust turbulence in the working area
- Safety lever prevents unintentional start of the machine
- Suitable for sanding belts 13 x 457 mm.

**System components**

Accessories → 181



Technical data	Air Disc Sander DSX 150
Sanding pad Ø	150 mm
Operating pressure	6.2 bar
Air requirement	550 l/min
Working stroke	5 mm
Speed (RPM)	12,000 /min
Weight	1 kg

**Scope of delivery**

Order no.	601558
EURO Plug-in nipple 1/4"	■
ARO/Orion Plug-in nipple 1/4"	■
ISO Plug-in nipple 1/4"	■
Open-jawed spanner	■
Hexagonal wrench	■
Oil bottles	■

**Product advantages**

- Ergonomic, insulated and lightweight housing made from impact-proof plastic
- Compact dimensions for convenient one-hand operation
- For grinding flat and curved surfaces in a variety of different materials
- Infinitely variable speed control for working with different materials
- Sound-proofed air outlet for reduced noise operation
- Suitable for wet and dry sanding/grinding
- Separate exhaust: connection option Ø 25 mm to external dust extraction
- 6-hole backing pad Ø 150 mm with hook and loop for use of currently available sandpapers

**System components**

Accessories → 346, 524



Technical data	Air Staple Gun and Nailer DKNG 40/50
Nail type	SKN
Nail length	15 - 50 mm
Staple type	90 + ES
Staple length	15 - 40 mm
Operating pressure	5 - 7 bar
Air requirement per impact	0.66 l
Weight	1.1 kg

**Scope of delivery**

Order no.	601562
EURO Plug-in nipple 1/4"	■
ARO/Orion Plug-in nipple 1/4"	■
ISO Plug-in nipple 1/4"	■
Oil bottles	■
Safety goggles	■
Plastic carry case	■

**Product advantages**

- For processing staples and nails
- For interior development, e.g. for fixing wall and ceiling panels or for attaching strips
- For fixing tongue and groove boards, chipboards etc
- Practical and lightweight for easy operation even in difficult to reach places
- Switching between staples and clinch head nails without conversion
- Safety mechanism prevents unintentional trigger action for the protection of the user
- Tool-free opening of the front cover for simple and rapid elimination of faults
- Ergonomic composite housing: insulated non-slip and low vibration for comfortable work
- Rubberised handle for ergonomic and fatigue-free operation
- User-friendly, rotating exhaust guide: no dust turbulence in the working area

**System components**

Accessories → 514



Technical data	Air Staple Gun DKG 80/16	Air Staple Gun DKG 90/40	Air Staple Gun DKG 114/65
Staple type	80	90 + ES	114
Staple length	4 - 16 mm	13 - 40 mm	32 - 65 mm
Operating pressure	5 - 7 bar	5 - 7 bar	5 - 8 bar
Air requirement per impact	0.34 l	0.66 l	1.5 l
Weight	0.78 kg	0.93 kg	2.5 kg

**Scope of delivery**

Order no.	601564	601566	601567
EURO Plug-in nipple 1/4"	■	■	■
ARO/Orion Plug-in nipple 1/4"	■	■	■
ISO Plug-in nipple 1/4"	■	■	■
Oil bottles	■	■	■
Safety goggles	■	■	■
Plastic carry case	■	■	■

**Product advantages**

- For fixing liners, materials, insulation material
- Practical and lightweight for easy operation even in difficult to reach places
- Ergonomic composite housing: insulated non-slip and low vibration for comfortable work
- For fixing tongue and groove boards, chipboards etc
- Practical and lightweight for easy operation even in difficult to reach places
- Protective rubber glove prevents damage to delicate surfaces
- Ergonomic composite housing: insulated non-slip and low vibration for comfortable work
- Tool-free opening of the front cover for simple and rapid elimination of faults
- For interior development, e.g. for fixing wall and ceiling panels or for attaching strips
- Thumbwheel depth control for accurate working results
- Safety mechanism prevents unintentional trigger action for the protection of the user
- Tool-free changeover between individual and series fixing
- User-friendly, rotating exhaust guide: no dust turbulence in the working area
- For processing staples
- Rubberised handle for ergonomic and fatigue-free operation

**System components**

Accessories → 514



Technical data	Air Pin Nailer DPN 25
Nail type	PN
Nail length	15 - 25 mm
Operating pressure	4.5 - 7 bar
Air requirement per impact	0.34 l
Weight	1 kg

**Scope of delivery**

Order no.	601563
EURO Plug-in nipple 1/4"	■
ARO/Orion Plug-in nipple 1/4"	■
ISO Plug-in nipple 1/4"	■
Oil bottles	■
Safety goggles	■
Plastic carry case	■

**Product advantages**

- For processing nails
- For fixing skirtings, glass and ornamental mouldings
- Practical and lightweight for easy operation even in difficult to reach places
- Protective rubber glove prevents damage to delicate surfaces
- Ergonomic composite housing: insulated non-slip and low vibration for comfortable work
- Rubberised handle for ergonomic and fatigue-free operation

**System components**

Accessories → 514



Technical data	Air Brad Nailer DSN 50
Nail type	SKN
Nail length	15 - 50 mm
Operating pressure	5 - 8 bar
Air requirement per impact	0.66 l
Weight	0.92 kg

**Scope of delivery**

Order no.	601568
EURO Plug-in nipple 1/4"	■
ARO/Orion Plug-in nipple 1/4"	■
ISO Plug-in nipple 1/4"	■
Oil bottles	■
Safety goggles	■
Plastic carry case	■

**Product advantages**

- For processing nails
- For interior development, e.g. for fixing wall and ceiling panels or for attaching strips
- Practical and lightweight for easy operation even in difficult to reach places
- Thumbwheel depth control for accurate working results
- Safety mechanism prevents unintentional trigger action for the protection of the user
- Tool-free opening of the front cover for simple and rapid elimination of faults
- Ergonomic composite housing: insulated non-slip and low vibration for comfortable work
- Rubberised handle for ergonomic and fatigue-free operation
- User-friendly, rotating exhaust guide: no dust turbulence in the working area

Staples



**Type 90, back width 5.8 mm/wire thickness 1.05 x 1.27 mm**  
 ■ Treated with resin  
 ■ Galvanized

Staple type	Width mm	Overall length mm	Sales unit	Suitable for	Order no.
Type 90	5.8	15	2,000	Kombi 32, Kombi 40/50, KG 90/25, KG 90/40	0901053790
Type 90	5.8	20	2,000	Kombi 32, Kombi 40/50, KG 90/25, KG 90/40	0901053804
Type 90	5.8	25	2,000	Kombi 32, Kombi 40/50, KG 90/25, KG 90/40	0901053812
Type 90	5.8	30	2,000	Kombi 32, Kombi 40/50, KG 90/40	0901053820
Type 90	5.8	35	2,000	Kombi 40/50, KG 90/40	0901053839
Type 90	5.8	40	2,000	Kombi 40/50, KG 90/40	0901053847



**Type 80, back width 12.8 mm/wire thickness 0.65 x 0.95 mm**  
 ■ Treated with resin  
 ■ Galvanized

Staple type	Width mm	Overall length mm	Sales unit	Suitable for	Order no.
Type 80	12.8	6	3,000	KG 80/16, DKG 80/16	0901053855
Type 80	12.8	8	3,000	KG 80/16, DKG 80/16	0901053863
Type 80	12.8	10	3,000	KG 80/16, DKG 80/16	0901053871
Type 80	12.8	12	3,000	KG 80/16, DKG 80/16	0901053880
Type 80	12.8	14	3,000	KG 80/16, DKG 80/16	0901053898
Type 80	12.8	16	3,000	KG 80/16, DKG 80/16	0901053901



**Type 114, back width 10.8 mm/wire thickness 1.60 x 1.40 mm**  
 ■ Treated with resin  
 ■ Galvanized according to DIN 18182

Staple type	Width mm	Overall length mm	Sales unit	Suitable for	Order no.
Type 114	10.8	35	10,000	DKG 114/65	628870000
Type 114	10.8	40	10,000	DKG 114/65	628871000
Type 114	10.8	45	10,000	DKG 114/65	628872000
Type 114	10.8	50	10,000	DKG 114/65	628873000
Type 114	10.8	65	10,000	DKG 114/65	628874000

Brad nails



■ Galvanized  
 ■ Wire thickness 0.9 x 1.2 mm

Nail type	Overall length mm	Sales unit	Suitable for	Order no.
Type SKN	16	1,000	Kombi 32, Kombi 40/50, SKN 50, DSN 50, DKNG 90/40	0901053715
Type SKN	20	1,000	Kombi 32, Kombi 40/50, SKN 50, DSN 50, DKNG 90/40	0901053723
Type SKN	25	1,000	Kombi 32, Kombi 40/50, SKN 50, DSN 50, DKNG 90/40	0901053731
Type SKN	30	1,000	Kombi 32, Kombi 40/50, SKN 50, DSN 50, DKNG 90/40	0901053740
Type SKN	35	1,000	Kombi 40/50, SKN 50, DSN 50, DKNG 90/40	0901053758
Type SKN	40	1,000	Kombi 40/50, SKN 50, DSN 50, DKNG 90/40	0901053766
Type SKN	45	1,000	Kombi 40/50, SKN 50, DSN 50, DKNG 90/40	0901053774
Type SKN	50	1,000	Kombi 40/50, SKN 50, DSN 50, DKNG 90/40	0901053782

Pin nails



■ Galvanized  
 ■ Wire thickness 0.64 x 0.64 mm

Nail type	Overall length mm	Sales unit	Suitable for	Order no.
Type PN	15	10,000	DPN 25	628860000
Type PN	18	10,000	DPN 25	628861000
Type PN	22	10,000	DPN 25	628862000
Type PN	25	10,000	DPN 25	628863000



Paint Spray Gun FSP 100



Paint Spray Gun FSP 600



Paint Spray Gun FSP 1000 S

Technical data

	Paint Spray Gun FSP 100	Paint Spray Gun FSP 600	Paint Spray Gun FSP 1000 S
Operating pressure	3.5 bar	4.5 bar	4.5 bar
Air requirement	50 - 100 l/min	240 l/min	240 l/min
Weight	0.2 kg	0.6 kg	0.7 kg

Scope of delivery

Order no.	601574	601575	601576
EURO Plug-in nipple 1/4"	■	■	■
ARO/Orion Plug-in nipple 1/4"	■	■	■
ISO Plug-in nipple 1/4"	■	■	■
Plastic flow bowl, 0.1 l	■		
Plastic flow bowl, 0.6 l		■	
Metal suction cap 1 l			■
Nozzle Ø 1.5 mm		■	■
Round spray nozzle Ø 1 mm	■		

Product advantages

- Compact, very handy paint spray gun for small areas, ideal for correction work
- Infinitely adjustable for circular and wide spray
- Air and paint volume regulation: accurate, even, and high application of paint for excellent results
- Infinitely adjustable for circular and wide spray
- Air and paint volume regulation: accurate, even, and high application of paint for excellent results

System components

Accessories → 517

01  
02  
03  
04  
05  
06  
07  
08  
09  
10  
11  
12  
13  
14  
15



Technical data	Paint Spray Gun FSP 600 HVLP	Paint Spray Gun FSP 600 LVLP
Operating pressure	2 bar	1.6 bar
Air requirement	170 l/min	136 l/min
Weight	0.7 kg	0.7 kg

Scope of delivery	601577	601578
Order no.	601577	601578
EURO Plug-in nipple 1/4"	■	■
ARO/Orion Plug-in nipple 1/4"	■	■
ISO Plug-in nipple 1/4"	■	■
Plastic flow bowl, 0.6 l	■	■
Filter	■	■
Nozzle Ø 1.3 mm	■	■
Cleaning brush	■	■
Assembly key	■	■

- Product advantages**
- HVLP (High Volume, Low Pressure): min. operating pressure 0.7 bar at the nozzle kit, transfer rate approximately 70%. Low overspray, maximum transfer efficiency with low air consumption
  - LVLP (Low Volume Low Pressure): min. operating pressure 0.7 bar at the nozzle kit, transfer rate approximately 73%. Low overspray, maximum transfer efficiency with very low air consumption
  - Infinitely adjustable for circular and wide spray
  - Easy to clean, for the highest precision and service life
  - Nozzle kit made from stainless steel, suitable for use with water-soluble materials and materials containing solvents

Accessories for paint spray guns



- Nozzle kits for paint spray guns**
- Consisting of spray head, paint nozzle, colour needle and gasket.
  - Nozzle kits for paint spray gun 600 HVLP/ LVLP without additional gasket.

Diameter mm	Suitable for	Order no.
1.2	FB 150, SB 200, FSP 600, FSP 1000 S	0901026858*
1.5	FB 150, SB 200, FSP 600, FSP 1000 S	0901026866*
2	FB 150, SB 200, FSP 600, FSP 1000 S	0901026882*
2.5	FB 150, SB 200, FSP 600, FSP 1000 S	0901026904*
1.3	FSP 600 HVLP	628807000*
1.5	FSP 600 HVLP	628808000*
1.8	FSP 600 HVLP	628809000*
2	FSP 600 HVLP	628810000*
1.3	FSP 600 LVLP	628811000*
1.5	FSP 600 LVLP	628812000*
1.8	FSP 600 LVLP	628813000*
2	FSP 600 LVLP	628814000*

Order no.
628815000*

**Spare plastic gravity feed cup**  
suitable for: FSP 600 HVLP, FSP 600 LVLP



Order no.
628806000*

**10 spare filters FSP 600 HVLP / FSP 600 LVLP**  
■ Plastic paint sieve for flow bowl 6.28215 of the paint spray guns FSP 600 HVLP/ LVLP  
suitable for: FSP 600 HVLP, FSP 600 LVLP

Recommended nozzle diameter for individual application	FSP 100	FSP 600	FSP 1000 S	FSP 600 HVLP	FSP 600 LVLP
Primer	-	1.5/2.0/2.5	1.5/2.0/2.5	1.5/1.8/2.0	1.5/1.8/2.0
Spatula	-	2.0/2.5	2.0/2.5	2.0	2.0
Filler	-	1.5	1.5	1.3/1.5/1.8	1.3/1.5/1.8
Single stage paint	1.0	1.2/1.5	1.2/1.5	1.3/1.5	1.3/1.5
Metallic lacquer	-	1.2/1.5	1.2/1.5	1.3/1.5	1.3/1.5
Clear coat	-	1.2/1.5	1.2/1.5	1.3/1.5	1.3/1.5
Water-based paint	-	-	-	1.3/1.5/1.8/2.0	1.3/1.5/1.8/2.0



Technical data	
<b>Sand Blasting Gun SSP 1000</b>	
Operating pressure	7 bar
Air requirement	300 l/min
Weight	0.55 kg

Scope of delivery	
Order no.	601569
EURO Plug-in nipple 1/4"	■
ARO/Orion Plug-in nipple 1/4"	■
ISO Plug-in nipple 1/4"	■
Metal suction cap and hardened spray nozzle	■

- Product advantages**
- Sand blasting gun for the removal of rust and paint residue in corners, in joints and on smaller surface areas
  - For use on all current steel, meaning universal use, ideal for small areas
  - Jet nozzle made from hardened steel for a long service life



Technical data	
<b>Spray Gun SPP 1000</b>	
Operating pressure	6 bar
Air requirement	200 l/min
Weight	0.62 kg

Scope of delivery	
Order no.	601570
EURO Plug-in nipple 1/4"	■
ARO/Orion Plug-in nipple 1/4"	■
ISO Plug-in nipple 1/4"	■
Metal suction cap 1 l	■

- Product advantages**
- Spray gun for a wide range of applications: spraying cold cleaners, detergents and spray oils
  - Suction cup with large aperture, easy to fill and clean

**System components**

Accessories → 524



Technical data	
<b>Combo-Spray Gun UBS 1000</b>	
Operating pressure	6 bar
Air requirement	180 l/min
Weight	0.4 kg

Scope of delivery	
Order no.	601571
EURO Plug-in nipple 1/4"	■
ARO/Orion Plug-in nipple 1/4"	■
ISO Plug-in nipple 1/4"	■

- Product advantages**
- Spray gun for cavity sealing and underfloor protection, compatible with usual screw cartridges (1l)



Technical data	
<b>Air Cartridge Gun DKP 310</b>	
Operating pressure	6 bar
Air requirement	65 l/min
Weight	0.46 kg

Scope of delivery	
Order no.	601573
EURO Plug-in nipple 1/4"	■
ARO/Orion Plug-in nipple 1/4"	■
ISO Plug-in nipple 1/4"	■

- Product advantages**
- Automatic: continuous material flow as long as trigger guard is activated; uniform flow at required rate
  - No material dripping for clean and effective operation
  - Uses ordinary cartridges (310 ml)



Technical data	
<b>Air Grease Gun DFP 400</b>	
Operating pressure	2 - 10 bar
Air requirement per stroke	0.4 l
Weight	1.55 kg

Scope of delivery	
Order no.	601572
EURO Plug-in nipple 1/4"	■
ARO/Orion Plug-in nipple 1/4"	■
ISO Plug-in nipple 1/4"	■
Rigid grease tube (17 cm)	■
Flexible grease hose 46 cm (18")	■

- Product advantages**
- Automatic: continuous material flow as long as trigger guard is activated; uniform flow at required rate
  - No material dripping for clean and effective operation
  - With a rigid and flexible connection including grease nipple, for best reachability and simple handling
  - For filling from external grease containers or for use with ordinary cartridges (400g)

01  
02  
03  
04  
05  
06  
07  
08  
09  
10  
11  
12  
13  
14  
15



Technical data	Tyre Inflation & Pressure Gauge RF 60	Tyre Inflation & Pressure Gauge RF 60 G
Operating pressure	0.5 - 12 bar	0.5 - 10 bar
Hose length	35 cm	35 cm
Weight	0.45 kg	0.45 kg

Scope of delivery	602233	602234
Order no.	602233	602234
EURO Plug-in nipple 1/4"	■	■
ARO/Orion Plug-in nipple 1/4"	■	■
ISO Plug-in nipple 1/4"	■	■
Tyre inflation plug in nipple, and hollow needle ball adaptor	■	

- Product advantages**
- Officially calibrated (including calibration fee) for use in commercial companies
  - For testing and inflating tyres
  - With torque plug
  - Manometer with rubber shroud to protect against damage



Technical data	Tyre Inflation & Pressure Gauge RF 80 G	Tyre Inflation & Pressure Gauge RF 80 D
Operating pressure	0.5 - 10 bar	0.5 - 12 bar
Hose length	100 cm	100 cm
Weight	0.55 kg	0.55 kg









Scope of delivery	602235	602236
Order no.	602235	602236
EURO Plug-in nipple 1/4"	■	■
ARO/Orion Plug-in nipple 1/4"	■	■
ISO Plug-in nipple 1/4"	■	■

- Product advantages**
- Officially calibrated (including calibration fee) for use in commercial companies
  - Digital, illuminated manometer for highest accuracy
  - Switchable display units: PSI, BAR, Kpa, kg/cm<sup>2</sup>
  - For testing and inflating tyres
  - Ergonomic composite housing: insulated non-slip and low vibration for comfortable work
  - Easy operation with precision gauge, overpressure safe
  - Handle with non-slip soft-grip surface
  - With torque plug
  - Large Ø 80 mm manometer for good readability
  - Manometer with rubber shroud to protect against damage

**System components**

Accessories → 521

Accessories for tyre inflators complete with pressure gauges

	Order no.
 Adapter for bicycle valve To inflate bicycle tyres with a tyre-inflator	0901026262*
 Adapter for hollow needle ball inflation To inflate balls with a tyre-inflator	0901031550*
 Valve set, 3-piece Consisting of bicycle valve adapter, ball adapter and adapter for air mattress	0901055769*
 Lever connector with clip Suitable for hose inside diameter 6 mm	7710672339
 Connecting hose (as spare); male thread: 1/4"	0901026661*
 Connecting hose with lever connector (as spare)	1001672319
 Manometer Ø 80 mm (1-10 bar) With protecting cap; calibrated; for RF 480	7823672327
 Manometer tyre-inflator (as spare); e.g. for RF 100	0901026815*

\*Self-service packaging

01  
02  
03  
04  
05  
06  
07  
08  
09  
10  
11  
12  
13  
14  
15



Technical data	Blow Gun BP 10	Blow Gun BP 210
Operating pressure	2 - 6 bar	2 - 6 bar
Air requirement	100 - 200 l/min	100 - 200 l/min
Weight	0.1 kg	0.14 kg

Scope of delivery	601579000	601579180	601579010	601580000	601580180	601580010
EURO Plug-in nipple 1/4"	■			■		
ARO/Orion Plug-in nipple 1/4"		■			■	
ISO Plug-in nipple 1/4"			■			■
Extension 210 mm				■	■	■

**Product advantages** ■ Light, robust housing made from cast aluminium



Technical data	Blow Gun BP 200	Blow Gun BP 500
Operating pressure	3 - 8 bar	3 - 8 bar
Air requirement	130 - 350 l/min	130 - 350 l/min
Weight	0.14 kg	0.16 kg

Scope of delivery	601581000	601581180	601581010	601582000	601582180	601582010
EURO Plug-in nipple 1/4"	■			■		
ARO/Orion Plug-in nipple 1/4"		■			■	
ISO Plug-in nipple 1/4"			■			■
Rubber-coated nozzle tip	■	■	■			
Extension 500 mm				■	■	■

**Product advantages** ■ Ergonomic, insulated and lightweight housing made from impact-proof plastic  
 ■ Air volume can be regulated for application-specific operation  
 ■ Practical and lightweight for easy operation even in difficult to reach places



Technical data	Blow Gun Alu BPA 15	Blow Gun Alu BPA 15 S
Operating pressure	2 - 6 bar	4 - 6 bar
Air requirement	295 l/min	335 l/min
Weight	0.26 kg	0.28 kg

Scope of delivery	601583000	601583180	601584000	601584180
EURO Plug-in nipple 1/4"	■		■	
ARO/Orion Plug-in nipple 1/4"		■		■
Safety and noise damping nozzle			■	■
Short nozzle	■	■		

**Product advantages** ■ Safety nozzle for safe operation

■ Light, robust housing made from cast aluminium  
 ■ Air volume can be regulated for application-specific operation











Technical data	Compressed Air Tool Set LPZ 4 Set	Compressed Air Tool Set LPZ 7 Set
Operating pressure	3 - 8 bar	3 - 8 bar
Air requirement	130 - 350 l/min	130 - 350 l/min
Weight	0.14 kg	0.16 kg

Scope of delivery	601585000	601585180	601585010	601586000	601586180	601586010
EURO Plug-in nipple 1/4"	■			■		
ARO/Orion Plug-in nipple 1/4"		■			■	
ISO Plug-in nipple 1/4"			■			■

**Product advantages** ■ Set consists of blow gun, tyre inflating measuring device, paint spray gun with gravity flow cup and PA spiral hose  
 ■ Set consists of blow gun, tyre inflating measuring device incl. adapter and ball needle, paint spray gun with gravity flow cup and PA spiral hose

Accessories for chipping hammers		
		Order no.
	<b>Stone chisel</b> Overall length: 173 mm; hexagonal shank bit SW 10	0901026521*
	<b>Stone chisel</b> 20 mm wide; overall length: 175 mm; hexagonal shank bit SW 10	0901026530*
	<b>Stone chisel</b> 50 mm wide; overall length: 180 mm; hexagonal shank bit SW 10	0901026548*
	<b>Stone chisel</b> 40 mm wide; overall length: 250 mm Hexagonal shank bit SW 10	0901026572*
	<b>Spring for chipping hammer MHS 315</b> 8 coils Suitable for MHS 315, DW 315	0901013047*
	<b>Spring for chipping hammer MHS 450</b> 10 coils Suitable for MHS 450, MHS 5050	0901026327*
	<b>Needle scaler attachment</b> Suitable for DMH 30 Set, DMH 290 Set, as well as all compressed air chipping hammers, universal	628822000

Accessories for large diameter saws		
		Order no.
	<b>Saw blades 14 teeth (10 pieces)</b>	0901063087*
	<b>Saw blades 24 teeth (10 pieces)</b>	0901063095*
	<b>Saw blades 32 teeth (10 pieces)</b>	0901063109*

Accessories for die grinders		
		Order no.
	<b>Collet 8 mm for DG 700 / DG 700 L</b>	628823000

Accessories for random orbital sander		
		Order no.
	<b>Spare sanding pad for ES 7700 / DSX 150</b>	1319706247

Accessories for sand blasting guns		
		Order no.
	<b>Sand blasting abrasive</b> ■ Grit 0.2 - 0.5 mm ■ Canister content 8 kg ■ Aluminium silicate glass melt	0901064423
	<b>Spare pipe for sandblasting gun</b>	0901026408

General accessories for compressed air tools		
		Order no.
	<b>Special oil 0.5 litres for compressed air tools</b> mineral	0901008540

Accessories for Compressors

Oils		
		Order no.
	<b>Compressor oil, 1 litre, for piston condenser</b> mineral	0901004170

Compressed Air Preparation

Maintenance units		
	<ul style="list-style-type: none"> <li>■ Consisting of filter controller FR and lubricator L</li> <li>■ Wall mounting: Line installation and control panel installation possible</li> </ul>	
Connecting thread	Maximum inlet pressure bar	Order no.
1/4"	12	0901063869
1/2"	14	0901063850

Filter controller		
	<ul style="list-style-type: none"> <li>■ Wall mounting: Line installation and control panel installation possible</li> </ul>	
Connecting thread	Maximum inlet pressure bar	Order no.
1/4"	12	0901063877
1/2"	14	0901063885

Controller		
	<ul style="list-style-type: none"> <li>■ Wall mounting: Line installation and control panel installation possible</li> </ul>	
Connecting thread	Maximum inlet pressure bar	Order no.
1/4"	12	0901063834
1/2"	14	0901063826

\*Self-service packaging



Filters



■ Wall mounting: Line installation and control panel installation possible

Connecting thread	Maximum inlet pressure bar	Order no.
1/4"	12	0901063818
1/2"	14	0901063800

Lubricators



■ Wall mounting: Line installation and control panel installation possible

Connecting thread	Maximum inlet pressure bar	Order no.
1/4"	12	0901063796
1/2"	14	0901063788

Line lubricator



Connecting thread	Order no.
1/4"	0901054584*

Oils



Special oil 0.5 litres for compressed air tools mineral

Order no.
0901008540



Pipe System

Compressed air lines



Outer Ø mm	Internal Ø mm	Length m	Material	Version	Order no.
15	12	25	Plastic	flexible (rolls)	7851194171
22	18	25	Plastic	flexible (rolls)	7851194180

Distributors

	Order no.
 <b>Wall disc</b> Plastic	7876194001
 <b>Diffuser can</b> Brass thread Without locking screw	0901059691
 <b>Locking screw 1/2"</b> Galvanized	6109079322

Connections



■ with male thread

Diameter mm	Connecting thread	Material	Order no.
22	3/4"	Plastic	7876193943
15	1/2"	Plastic	7876193951

Plug connectors

Diameter mm	Material	Order no.
<b>T-plug connectors</b>		
15	Plastic	7876194010
22	Plastic	7876194028
<b>Angle plug connectors</b>		
15	Plastic	7876194060
22	Plastic	7876194079
<b>Straight plug connectors</b>		
15	Plastic	7876194125
22	Plastic	7876194133

Pipe sockets



Diameter mm	Connecting thread	Material	Order no.
15	1/2"	Plastic	7876193978
22	1/2"	Plastic	7876193986
22	3/4"	Plastic	7876193994

Air cocks



Diameter mm	Connecting thread	Order no.
15	1/2"	0901059489
22	3/4"	0901059500

Safety rings



Diameter mm	Material	Order no.
22	Plastic	7876194117

Tubular joints



Diameter mm	Material	Order no.
15	Plastic	7876693610
22	Plastic	7876693628

Pipe cutter



Pipe cutter  
Maximum diameter: 28 mm

Order no.  
9109691680

Compressed Air Hoses

Compressed air hoses with fabric insert



- For all normal applications

Length m	Internal Ø mm	Outer Ø mm	Maximum pressure bar	Profile	Version	Order no.
5	6	11	20	Euro	With quick-action coupling and nipple	0901054908
5	6	11	20	ISO	With quick-action coupling and nipple	628779000
10	6	11	20	Euro	With quick-action coupling and nipple	0901054916
10	9	14	20	Euro	With quick-action coupling and nipple	0901054924
10	9	14	20	ISO	With quick-action coupling and nipple	628781000
50	9	14	20	-	rolls	0901054932
50	12.5	18	12	-	rolls	0901056161

Super Air compressed air hoses



- Very flexible hose, even at low temperatures
- Resistant against compressed air containing oil

Length m	Internal Ø mm	Outer Ø mm	Maximum pressure bar	Profile	Version	Order no.
10	6.3	11	20	Euro	With quick-action coupling and nipple	0901056048
10	6.3	11	20	ARO	With quick-action coupling and nipple	0901058903
10	10	15.5	20	Euro	With quick-action coupling and nipple	0901056056
10	10	15.5	20	ARO	With quick-action coupling and nipple	0901057290
10	10	15.5	20	ISO	With quick-action coupling and nipple	628783000
50	10	15.5	20	-	rolls	0901057303

Spiral hoses, Rilsan







Length m	Internal Ø mm	Outer Ø mm	Maximum pressure bar	Profile	Version	Order no.
5	6	8	8	Euro	With quick-action coupling and nipple	0901054940
5	6	8	8	ARO	With quick-action coupling and nipple	0901056218
5	6	8	8	ISO	With quick-action coupling and nipple	628768000
7.5	6	8	8	Euro	With quick-action coupling and nipple	0901054959
7.5	6	8	8	ARO	With quick-action coupling and nipple	0901056226
7.5	6	8	8	ISO	With quick-action coupling and nipple	628769000
10	8	10	8	Euro	With quick-action coupling and nipple	0901054967

Spiral hose, polyurethane







- Highly elastic special hose for professional applications
- No permanent reduction of volume due to kinks
- Non-abrasive

Length m	Internal Ø mm	Outer Ø mm	Maximum pressure bar	Profile	Version	Order no.
6	8	12	8	Euro	With quick-action coupling and nipple	0901062145

Hose reels		Order no.
	<b>Hose recoiler SA 100</b> <ul style="list-style-type: none"> <li>With 20 m compressed air hose with fabric insert</li> <li>Quick connection coupling 1/4" Euro and plug-in nipple 1/4"</li> </ul> Length: 20 m Internal Ø: 9 mm External Ø: 15 mm Max. pressure: 15 bar Weight: 4 kg	0901054975
	<b>Hose reel ST 200</b> <ul style="list-style-type: none"> <li>With 30 m highly flexible PU hose</li> <li>Quick connection coupling 1/4" Universal and plug-in nipple 1/4" (Euro, ARO and ISO)</li> <li>360° rotating</li> </ul> Length: 30 m Internal Ø: 8.5 mm External Ø: 12.5 mm Max. pressure: 12 bar Weight: 8 kg	0901054568
	<b>Hose recoiler SA 250</b> <ul style="list-style-type: none"> <li>With 8 m highly flexible PU hose</li> <li>Quick connection coupling 1/4" Universal and plug-in nipple 1/4" (Euro, ARO and ISO)</li> <li>Automatic function: lock and recoil simply by pulling the hose.</li> <li>With wall and ceiling mounting brackets</li> <li>Plastic sleeve</li> </ul> Length: 8 m Internal Ø: 8 mm External Ø: 12 mm Max. pressure: 15 bar Weight: 2.9 kg	628820000
<b>NEW</b> 	<b>Hose recoiler SA 312</b> <ul style="list-style-type: none"> <li>With 12 m highly flexible PU hose</li> <li>Quick connection coupling 1/4" Universal and plug-in nipple 1/4" (Euro, ARO and ISO)</li> <li>Automatic function: lock and recoil simply by pulling the hose.</li> <li>With wall and ceiling mounting brackets</li> <li>Metal housing</li> <li>Length of connecting hose 1 m</li> </ul> Length: 12 m Internal Ø: 8 mm External Ø: 12 mm Max. pressure: 12 bar Weight: 8 kg	628824000

Brass Parts

Compressed air distributors						
	Version	Connecting size	Profile	Packaging	Sales unit	Order no.
	Female thread	3/8"	Euro	Self-service packaging	1	0901026645*
	Female thread	3/8"	Euro	Self-service packaging	1	0901026653*
	Female thread	3/8"	-	Self-service packaging	1	628759000*
	Female thread	3/8"	-	Self-service packaging	1	628760000*

Quick connection couplings Euro



**Quick connection couplings Euro with male thread**  
 ■ Brass coupling for plug-in nipple with Euro profile

Version	Connecting size	Packaging	Sales unit	Order no.
Male thread	1/4"	Self-service packaging	1	0901031517*
Male thread	3/8"	Self-service packaging	1	0901025894*
Male thread	1/2"	Self-service packaging	1	0901025908*
Male thread	1/4"	Loose	1	7802009083
Male thread	3/8"	Loose	1	7802009091
Male thread	1/2"	Loose	1	7802009105



**Quick connection couplings Euro with female thread**  
 ■ Brass coupling for plug-in nipple with Euro profile

Version	Connecting size	Packaging	Sales unit	Order no.
Female thread	1/4"	Self-service packaging	1	0901025916*
Female thread	3/8"	Self-service packaging	1	0901025924*
Female thread	1/2"	Self-service packaging	1	0901025932*
Female thread	1/4"	Loose	1	7801009055
Female thread	3/8"	Loose	1	7801009063
Female thread	1/2"	Loose	1	7801009071

\*Self-service packaging



**Quick connection couplings Euro with nozzle**  
 ■ Brass coupling for plug-in nipple with Euro profile

Version	Connecting size	Packaging	Sales unit	Order no.
with spout	6 mm	Self-service packaging	1	0901025940*
with spout	9 mm	Self-service packaging	1	0901026351*
with spout	13 mm	Self-service packaging	1	0901026360*
with spout	6 mm	Loose	1	7800009035
with spout	9 mm	Loose	1	7800009043
with spout	13 mm	Loose	1	7800009558

**Quick connection couplings UNI**



**Quick connection couplings UNI with male thread**  
 ■ Universal coupling for plug-in nipple with Euro, ARO or ISO profile

Version	Connecting size	Packaging	Sales unit	Order no.
Male thread	1/4"	Self-service packaging	1	628700000*
Male thread	3/8"	Self-service packaging	1	628701000*
Male thread	1/2"	Self-service packaging	1	628702000*



**Quick connection couplings UNI with female thread**  
 ■ Universal coupling for plug-in nipple with Euro, ARO or ISO profile

Version	Connecting size	Packaging	Sales unit	Order no.
Female thread	1/4"	Self-service packaging	1	628703000*
Female thread	3/8"	Self-service packaging	1	628704000*
Female thread	1/2"	Self-service packaging	1	628705000*



**Quick connection couplings UNI with nozzle**  
 ■ Universal coupling for plug-in nipple with Euro, ARO or ISO profile

Version	Connecting size	Packaging	Sales unit	Order no.
with spout	6 mm	Self-service packaging	1	628706000*
with spout	9 mm	Self-service packaging	1	628707000*
with spout	13 mm	Self-service packaging	1	628708000*

**Plug-in nipples Euro**



**Plug-in nipples Euro with male thread**  
 ■ For use with Euro and UNI couplings

Version	Connecting size	Packaging	Sales unit	Order no.
Male thread	1/4"	Self-service packaging	1	0901025983*
Male thread	3/8"	Self-service packaging	1	0901025991*
Male thread	1/2"	Self-service packaging	1	628736000*
Male thread	1/4"	Loose	1	7803009117
Male thread	3/8"	Loose	1	7803009133
Male thread	1/2"	Loose	1	628738000



**Plug-in nipples Euro with female thread**  
 ■ For use with Euro and UNI couplings

Version	Connecting size	Packaging	Sales unit	Order no.
Female thread	1/4"	Self-service packaging	1	0901026017*
Female thread	3/8"	Self-service packaging	1	0901026025*
Female thread	1/2"	Self-service packaging	1	628737000*
Female thread	1/4"	Loose	1	7803009125
Female thread	3/8"	Loose	1	7803009141
Female thread	1/2"	Loose	1	628739000



**Plug-in nipples Euro with nozzle**  
 ■ For use with Euro and UNI couplings

Version	Connecting size	Packaging	Sales unit	Order no.
with spout	6 mm	Self-service packaging	1	0901025959*
with spout	6 mm	Self-service packaging	1	0901025967*
with spout	13 mm	Self-service packaging	1	0901025975*
with spout	6 mm	Loose	1	7804065606
with spout	9 mm	Loose	1	7804009161
with spout	13 mm	Loose	1	7804010372

**Plug-in nipples ARO**



**Plug-in nipples ARO with male thread**  
 ■ For use with ARO and UNI couplings

Version	Connecting size	Packaging	Sales unit	Order no.
Male thread	1/4"	Self-service packaging	1	628730000*
Male thread	3/8"	Self-service packaging	1	628731000*
Male thread	1/2"	Self-service packaging	1	628734000*



**Plug-in nipples ARO with female thread**  
 ■ For use with ARO and UNI couplings

Version	Connecting size	Packaging	Sales unit	Order no.
Female thread	1/4"	Self-service packaging	1	628732000*
Female thread	3/8"	Self-service packaging	1	628733000*
Female thread	1/2"	Self-service packaging	1	628735000*



**Plug-in nipples ARO with nozzle**  
 ■ For use with ARO and UNI couplings

Version	Connecting size	Packaging	Sales unit	Order no.
with spout	6 mm	Self-service packaging	1	628720000*
with spout	9 mm	Self-service packaging	1	628721000*
with spout	13 mm	Self-service packaging	1	628722000*

\*Self-service packaging

Plug-in nipples ISO



Plug-in nipples ISO with male thread  
■ For use with ISO and UNI couplings

Version	Connecting size	Packaging	Sales unit	Order no.
Male thread	1/4"	Self-service packaging	1	628747000*
Male thread	3/8"	Self-service packaging	1	628748000*
Male thread	1/2"	Self-service packaging	1	628749000*



Plug-in nipples ISO with female thread  
■ For use with ISO and UNI couplings

Version	Connecting size	Packaging	Sales unit	Order no.
Female thread	1/4"	Self-service packaging	1	628754000*
Female thread	3/8"	Self-service packaging	1	628755000*
Female thread	1/2"	Self-service packaging	1	628756000*



Plug-in nipples ISO with nozzle  
■ For use with ISO and UNI couplings

Version	Connecting size	Packaging	Sales unit	Order no.
with spout	6 mm	Self-service packaging	1	628740000*
with spout	9 mm	Self-service packaging	1	628741000*
with spout	13 mm	Self-service packaging	1	628746000*

Double nipples

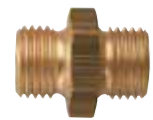

Version	Connecting size	Packaging	Sales unit	Order no.
Male thread x male thread	1/4" x 1/4"	Self-service packaging	1	0901026130*
Male thread x male thread	3/8" x 3/8"	Self-service packaging	1	0901026149*
Male thread x male thread	1/2" x 1/2"	Self-service packaging	1	0901026157*
Male thread x male thread	1/4" x 1/4"	Loose	1	7806009185
Male thread x male thread	3/8" x 3/8"	Loose	1	7806034996
Male thread x male thread	1/2" x 1/2"	Loose	1	7806009207

Reducing double nipples



Version	Connecting size	Packaging	Sales unit	Order no.
Male thread x male thread	1/4" x 3/8"	Self-service packaging	1	0901026173*
Male thread x male thread	1/4" x 1/2"	Self-service packaging	1	0901026190*
Male thread x male thread	3/8" x 1/2"	Self-service packaging	1	0901026203*
Male thread x male thread	1/8" x 1/4"	Loose	1	7808009247

Reducers



Version	Connecting size	Packaging	Sales unit	Order no.
Female thread x male thread	1/4" x 3/8"	Self-service packaging	1	0901026220*
Female thread x male thread	1/4" x 1/2"	Self-service packaging	1	0901026238*
Female thread x male thread	3/8" x 1/2"	Self-service packaging	1	0901026246*
Female thread x male thread	1/2" x 3/4"	Self-service packaging	1	0901026254*
Female thread x male thread	1/8" x 1/4"	Loose	1	7809009275
Female thread x male thread	1/4" x 3/8"	Loose	1	7809009283
Female thread x male thread	1/4" x 1/2"	Loose	1	7809035764
Female thread x male thread	3/8" x 1/2"	Loose	1	7809009291

Hose nozzles



Hose nozzles with male thread  
■ Brass hose nozzle

Version	Connecting size	Packaging	Sales unit	Order no.
Male thread x sleeve	1/4" x 6 mm	Self-service packaging	1	0901026041*
Male thread x sleeve	1/4" x 9 mm	Self-service packaging	1	0901026068*
Male thread x sleeve	3/8" x 6 mm	Self-service packaging	1	0901026050*
Male thread x sleeve	3/8" x 9 mm	Self-service packaging	1	0901026076*
Male thread x sleeve	1/4" x 6 mm	Loose	1	7805009343
Male thread x sleeve	3/8" x 6 mm	Loose	1	7805009351
Male thread x sleeve	1/4" x 9 mm	Loose	1	7805009440
Male thread x sleeve	3/8" x 9 mm	Loose	1	7805009483
Male thread x sleeve	1/4" x 13 mm	Loose	1	7805033767
Male thread x sleeve	1/2" x 13 mm	Loose	1	7805009300
Male thread x sleeve	3/8" x 13 mm	Loose	1	7805009319



Hose nozzles with female thread  
■ Brass hose nozzle

Version	Connecting size	Packaging	Sales unit	Order no.
Female thread x sleeve	1/4" x 6 mm	Self-service packaging	1	0901026084*
Female thread x sleeve	1/4" x 9 mm	Self-service packaging	1	0901026092*
Female thread x sleeve	3/8" x 6 mm	Self-service packaging	1	0901026289*
Female thread x sleeve	3/8" x 9 mm	Self-service packaging	1	0901026106*
Female thread x sleeve	3/8" x 6 mm	Loose	1	7805009459
Female thread x sleeve	1/4" x 6 mm	Loose	1	7805009416
Female thread x sleeve	1/4" x 9 mm	Loose	1	7805009432
Female thread x sleeve	3/8" x 9 mm	Loose	1	7805009475

\*Self-service packaging



01  
02  
03  
04  
05  
06  
07  
08  
09  
10  
11  
12  
13  
14  
15

Hose connection sleeve



Version	Connecting size	Packaging	Sales unit	Order no.
Sleeve x sleeve	6 mm x 6 mm	Self-service packaging	1	0901026378*
Sleeve x sleeve	9 mm x 9 mm	Self-service packaging	1	0901026386*
Sleeve x sleeve	6 mm x 6 mm	Loose	1	7807009367
Sleeve x sleeve	9 mm x 9 mm	Loose	1	7807009375

Clamps

	From Ø mm	To Ø mm	Packaging	Sales unit	Order no.
<b>Screw clamps</b>					
					
	9.5	11.5	Self-service packaging	5	0901026777*
	12	20	Self-service packaging	5	0901026807*
<b>Screw clamps</b>					
					
	11	13	Self-service packaging	5	0901054983*
	13	15	Self-service packaging	5	0901054991*

Fabric sealing tape



- Fabric sealing tape**
- Seals without hemp or sealing paste
  - For metal and plastic threaded joints
- Length on roll: 12 m

Order no.  
0901026319\*



# Water and Pump Technology

### Drainage: Which pump for which application?

	Clear water							Dirty water								
	Clear Water Submersible Pumps							Combi-nation Pumps	Construction and Dirty Water Pumps				Dirty Water Submersible Pumps			
	TP 6600	TPF 6600 SN	TPF 7000 S	TP 7500 SI	TP 8000 S	TP 12000 SI	TP 13000 S	TPS 14000 S Combi	TPS 16000 S Combi	DP 18-5 SA	DP 28-10 S Inox	SP 24-46 SG	SP 28-50 S Inox	PS 7500 S	PS 15000 S	PS 18000 SN
Pumping empty, circulation of clear water from containers, pools, ponds etc.	■	■	■	■	■	■	■	■	■	■	■	■	■	■	■	■
Pumping empty, circulation of dirty water								■	■	■	■	■	■	■	■	■
Low-intake suction		■	■	■		■		■	■							
Minimal residual water level after pumping empty (mm)	7	2	2	2	7	2	4	3	3	22	28	41	48	34	39	48
Shaft drainage (depending on the size of the shaft)								■	■	■	■	■	■	■	■	■
Drainage of clear water from cellars / ponds	■	■	■	■	■	■	■	■	■							
Drainage of very dirty water from cellars / ponds										■	■					
Pumping-dry construction pits and flooded areas										■	■	■	■			
High water protection								■	■	■	■	■	■			
Fire and water restoration								■	■	■	■	■	■			
Agricultural use										■	■	■	■			
Industrial use												■	■			

### Irrigation: Which pump for which application?

	Irrigation						Domestic Water Supply																
	Garden Pumps			Sub-mer-sible Pressure Pump	Deep Well Pumps	Domestic Waterworks						Automatic Domestic Water Systems											
	P 2000 G	P 3300 G	P 4000 G	P 4500 Inox	P 6000 Inox	P 9000G	TDP 7501 S	TBP 4000 M	TBP 5000 M	HWW 3300/25 G	HWW 3500/25 Inox	HWWI 3500/25 Inox	HWW 4000/25 G	HWW 4500/25 Inox	HWW 4500/25 Inox Plus	HWWI 4500/25 Inox	HWW 6000/25 Inox	HWW 6000/50 Inox	HWW 9000/100 G	HWA 3500 Inox	HWA I 4500 Inox	HWA 6000 Inox	
Groundwater pumping	■	■	■	■	■	■		■	■	■	■	■	■	■	■	■	■	■	■	■	■	■	■
Garden irrigation	■	■	■	■	■	■	■	■	■	■	■	■	■	■	■	■	■	■	■	■	■	■	■
Garden irrigation: Number of possible attachments (e.g. sprinkler, showers)	2	2	2	3	4	6	3	3	3	2	2	2	3	3	3	3	4	4	4	6	2	3	4
Pumping, pumping empty, circulation of clear water	■	■	■	■	■	■	■	■	■	■	■	■	■	■	■	■	■	■	■	■	■	■	■
Automatic Domestic Water Supply										■	■	■	■	■	■	■	■	■	■	■	■	■	■
Pumping of water from wells, deeper springs							■	■	■														
Pumping of water from greater depths e.g. bore holes / shafts min. Ø 100 mm								■	■														
Pressure increase										■	■	■	■	■	■	■	■	■	■	■	■	■	■
Automatic water supply in the agricultural area																					■	■	■

**Delivery height**

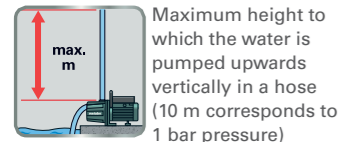

**Delivery output / delivery rate**

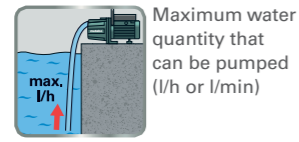

**Suction height**

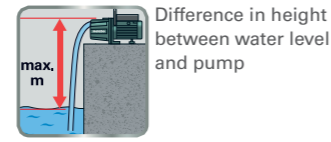

**Free passage**

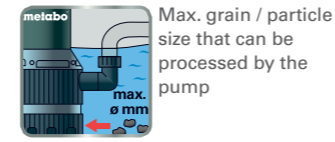

### Calculation of the required delivery output and the required pressure.

Calculation example for required pressure		Calculation
<b>A</b>	Delivery height	14 m : 10 = 1.4
	Suction height + pressure head (10 m = 1 bar)	+
<b>B</b>	Length suction hose	7 m x 0,005 = 0,035
	(Calculation friction loss with a hose Ø 1"= 0.005)	+
<b>C</b>	Length pressure hose	20 m x 0,015 = 0.3
	(Calculation friction loss with a hose Ø 3/4"= 0.015)	+
	Required minimum pressure in general	2 bar
		=
<b>1</b>	Required minimum pressure in total:	3.7 bar

Calculation example required amount of water		Calculation
<b>D</b>	Delivery rate (water consumption of all connected consumers, e.g. sprinkler, toilet)	700 l/h
		+
	Water requirements house (Estimate 1 house with 5 persons)	2,000 l/h
		=
<b>2</b>	Required amount of water in total:	2,700 l/h

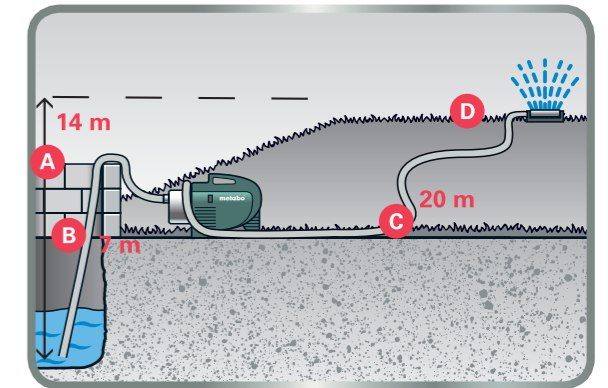

### Pump characteristics

#### Clear Water Submersible Pumps

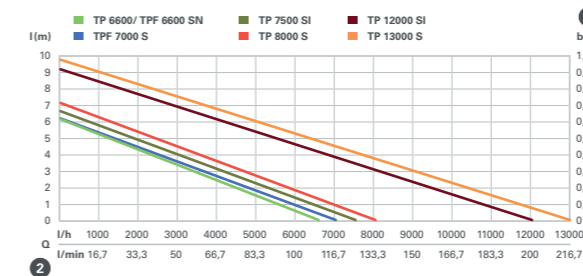

#### Combi Submersible Pumps



#### Construction and Dirty Water Pumps

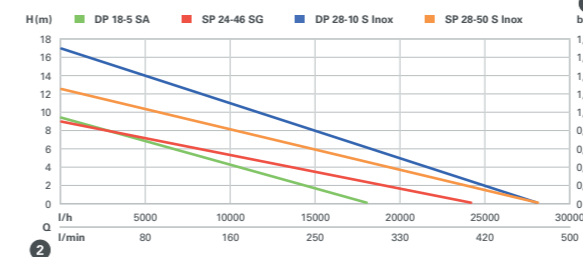

#### Dirty Water Submersible Pumps

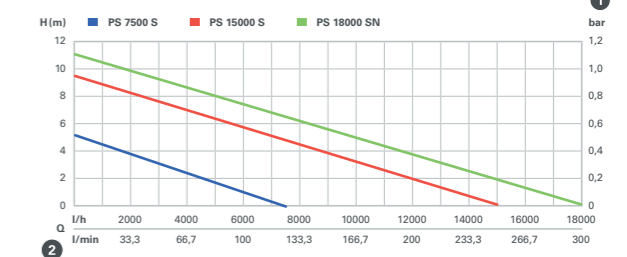

#### Garden Pumps

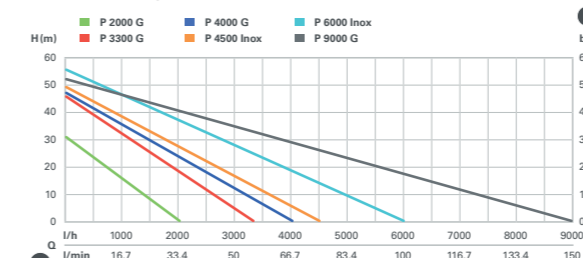

#### Deep Well Pumps / Submersible Pressure Pumps

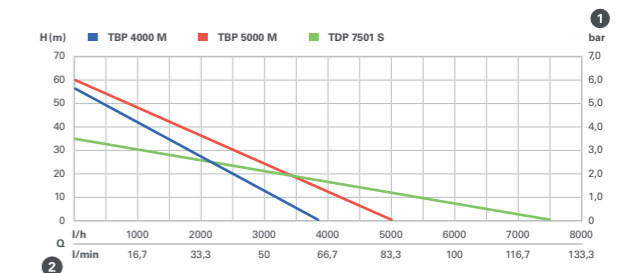

#### Domestic Waterworks

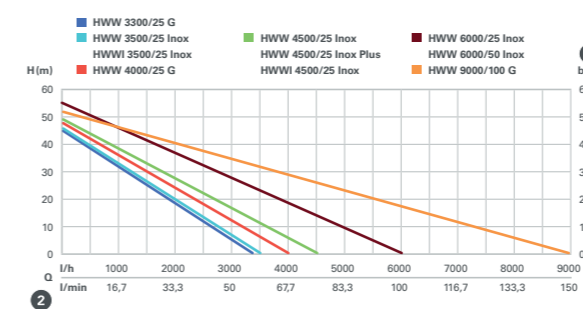

#### Automatic Domestic Water Systems

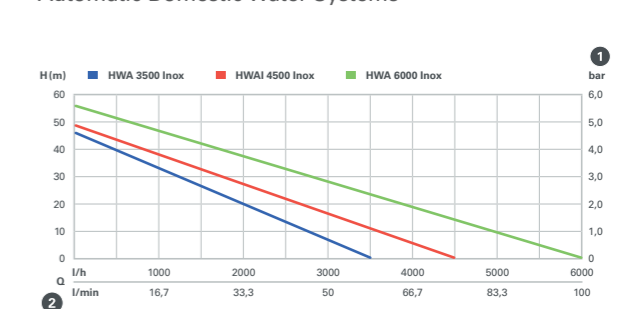



Technical data	Clear Water Submersible Pump TP 6600	Clear Water Submersible Pump TP 8000 S	Clear Water Submersible Pump TP 13000 S
Rated input power	250 W	350 W	550 W
Maximum delivery rate	6,600 l/h	8,000 l/h	13,000 l/h
Maximum delivery height	6 m	7 m	9.5 m
Maximum pressure	0.6 bar	0.7 bar	0.95 bar
Maximum immersion depth	5 m	5 m	5 m
Discharge port	1 1/4" female thread	1 1/4" female thread	1 1/4" female thread
Pump housing	Plastic	Plastic	Plastic
Number of impellers	1	1	1
Weight	4.3 kg	4.3 kg	5 kg
Cable length	10 m	10 m	10 m

**Scope of delivery**

Order no.	0250660000	0250800000	0251300000
Angle connection piece with multi-adapter	■	■	■
Float switch		■	■

**Product advantages**

- Adjustable float switch for automatic mode
- Adjustable float switch for automatic mode
- For pumping empty, pumping dry and circulating clear water from containers, tanks, tanks or flooded cellars
- For garden irrigation from water reservoirs
- Overload protection: protects the motor from overheating
- Robust housing made of impact-proof plastic
- Ergonomic handle for comfortable transport



Technical data	Flat-suction Clear Water Submersible Pump TPF 6600 SN	Flat-suction Clear Water Submersible Pump TPF 7000 S
Rated input power	450 W	450 W
Maximum delivery rate	6,600 l/h	7,000 l/h
Maximum delivery height	6 m	6 m
Maximum pressure	0.6 bar	0.6 bar
Maximum immersion depth	5 m	5 m
Discharge port	1 1/4" female thread	1 1/4" female thread
Pump housing	Stainless steel	Plastic
Number of impellers	1	1
Weight	4.6 kg	4.6 kg
Cable length	10 m	10 m

**Scope of delivery**

Order no.	0250660006	0250800002
Angle connection piece with multi-adapter	■	■
Float switch	■	■

**Product advantages**

- Durable housing made of non-corrosive stainless steel
- Robust housing made of impact-proof plastic
- For pumping empty, pumping dry and circulating clear water from containers, tanks, tanks or flooded cellars
- For garden irrigation from water reservoirs
- Overload protection: protects the motor from overheating
- Low-intake level up to a residual water level of 2-3 mm
- Adjustable float switch for automatic mode
- Ergonomic handle for comfortable transport

**System components**

Accessories → 559

**System components**

Accessories → 559

01  
02  
03  
04  
05  
06  
07  
08  
09  
10  
11  
12  
13  
14  
15





Technical data	Flat-suction Clear Water Submersible Pump TP 7500 SI	Flat-suction Clear Water Submersible Pump TP 12000 SI
Rated input power	300 W	600 W
Maximum delivery rate	7,500 l/h	11,700 l/h
Maximum delivery height	6.5 m	9 m
Maximum pressure	0.65 bar	0.9 bar
Maximum immersion depth	5 m	7 m
Discharge port	1 1/4" Male Thread	1 1/4" Male Thread
Pump housing	Plastic	Plastic
Number of impellers	1	1
Weight	4.2 kg	5.1 kg
Cable length	10 m	10 m

Scope of delivery		
Order no.	0250750013	0251200009
Multi-adapter	■	■

- Product advantages**
- For pumping empty, pumping dry and circulating clear water from containers, tanks, tanks or flooded cellars
  - For garden irrigation from water reservoirs
  - Overload protection: protects the motor from overheating
  - Low-intake level up to a residual water level of 2-3 mm
  - Integrated float switch for automatic mode
  - Integrated check valve and automatic bleed
  - Problem-free use in narrower shafts up to 25 x 25 cm
  - Universal port

**System components**

Accessories → 559



Technical data	Submersible Pressure Pump TDP 7501 S
Rated input power	1,000 W
Maximum delivery rate	7,500 l/h
Maximum delivery height	34 m
Maximum pressure	3.4 bar
Maximum immersion depth	7 m
Discharge port	1" female thread
Pump housing	Plastic
Number of impellers	3
Weight	9.1 kg
Cable length	10 m

Scope of delivery	
Order no.	0250750100
Multi-adapter	■
Float switch	■

- Product advantages**
- For garden irrigation from water reservoirs
  - For directly operating irrigation systems as well as for watering and garden irrigation using bore water, wells or cisterns
  - For garden irrigation with 1 to 3 sprinklers
  - 3-level pump gearing provides optimum pressure build-up
  - Overload protection: protects the motor from overheating
  - Adjustable float switch for automatic mode
  - Integrated non-return valve reliably prevents the water pipe from running dry
  - Robust housing made of impact-proof plastic
  - Ergonomic handle for comfortable transport

**System components**

Accessories → 559



Technical data	Combi Submersible Pump TPS 14000 S Combi	Combi Submersible Pump TPS 16000 S Combi
Rated input power	770 W	970 W
Maximum delivery rate	14,000 l/h	16,000 l/h
Maximum delivery height	8.5 m	9.5 m
Maximum pressure	0.85 bar	0.95 bar
Maximum immersion depth	7 m	7 m
Discharge port	1 1/2" female thread	1 1/2" female thread
Pump housing	Plastic	Plastic
Maximum particle size up to	20 mm	30 mm
Number of impellers	1	1
Weight	7.7 kg	7.8 kg
Cable length	10 m	10 m

Scope of delivery

Order no.	0251400000	0251600000
Angle connection piece with multi-adapter	■	■
Float switch	■	■

Product advantages

- As dirty water submersible pump suitable for coarse fluids with a particle size of up to 20 mm
- As dirty water submersible pump suitable for coarse fluids with a particle size of up to 30 mm
- Multi-functional use as submersible pump for fresh water or dirty water
- For pumping empty, pumping dry and circulating fresh water and dirty water from containers, tanks or flooded cellars
- For garden irrigation from water reservoirs
- Low-intake up to 1 mm in clear water mode
- Simple and comfortable adjustment of the pump base for the required function
- Double seal system for protection of the pump if the water is particularly dense or contains large particles
- Overload protection: protects the motor from overheating
- Adjustable float switch for automatic mode
- Easy switching over from automatic mode with float switch to manual mode for low-intake suction
- Housing made of impact-proof plastic
- Ergonomic handle for comfortable transport

System components

Accessories → 559



Technical data	Dirty Water Submersible Pump PS 7500 S	Dirty Water Submersible Pump PS 15000 S	Dirty Water Submersible Pump PS 18000 SN
Rated input power	450 W	850 W	1,100 W
Maximum delivery rate	7,500 l/h	15,000 l/h	19,000 l/h
Maximum delivery height	5 m	9.5 m	11 m
Maximum pressure	0.5 bar	0.95 bar	1.1 bar
Maximum immersion depth	5 m	5 m	7 m
Discharge port	1 1/4" female thread	1 1/4" female thread	1 1/2" female thread
Pump housing	Plastic	Plastic	Stainless steel
Maximum particle size up to	30 mm	30 mm	35 mm
Number of impellers	1	1	1
Weight	4.8 kg	6.5 kg	7.9 kg
Cable length	10 m	10 m	10 m

Scope of delivery

Order no.	0250750000	0251500000	0251800000
Angle connection piece with multi-adapter	■	■	■
Float switch	■	■	■

Product advantages

- Robust housing made of impact-proof plastic
- Robust housing made of impact-proof plastic
- Durable housing made of non-corrosive stainless steel
- For pumping empty, pumping dry and circulating fresh water or dirty water from containers, tanks or flooded cellars
- For garden irrigation from water reservoirs
- Double seal system for protection of the pump if the water is particularly dense or contains large particles
- Overload protection: protects the motor from overheating
- Adjustable float switch for automatic mode
- Ergonomic handle for comfortable transport

System components

Accessories → 559

01  
02  
03  
04  
05  
06  
07  
08  
09  
10  
11  
12  
13  
14  
15



Technical data	Drainage Pump DP 18-5 SA	Drainage Pump DP 28-10 S Inox
Rated input power	900 W	1,850 W
Maximum delivery rate	18,000 l/h	28,000 l/h
Maximum delivery height	9.4 m	17 m
Maximum pressure	0.94 bar	1.7 bar
Maximum immersion depth	7 m	7 m
Discharge port	1 1/2" female thread	1 1/2" female thread
Pump housing	Aluminium	Stainless steel
Maximum particle size up to	5 mm	10 mm
Number of impellers	1	1
Weight	10 kg	18.5 kg
Cable length	10 m	10 m

Scope of delivery

Order no.	604111	604112
Float switch	■	■

Product advantages

- Mechanical seal for protection of the pump if the water is particularly dense or contains large particles
- Ideal motor cooling by means of the conveyed medium even when the water level is low
- Double mechanical seal with oil chamber for ideal protection of the pump if the water is very dirty
- Durable pump housing made of non-corrosive, high-quality stainless steel
- For effective pumping of large quantities of dirty water, rain water, ground water and water on construction sites
- Self-cleaning Vortex-impeller to minimise blockages
- Designed for continuous mode with S1 motor operating mode
- Overload protection: protects the motor from overheating
- Float switch for automatic mode
- Suitable for mobile and stationary use thanks to ergonomic handles and stability

System components

Accessories → 559



Technical data	Dirty Water Pump SP 24-46 SG	Dirty Water Pump SP 28-50 S Inox
Rated input power	900 W	1,470 W
Maximum delivery rate	24,000 l/h	28,000 l/h
Maximum delivery height	9 m	12 m
Maximum pressure	0.9 bar	1.2 bar
Maximum immersion depth	7 m	7 m
Discharge port	2" female thread	2" female thread
Pump housing	Grey cast iron	Stainless steel
Maximum particle size up to	46 mm	50 mm
Number of impellers	1	1
Weight	17.9 kg	19.3 kg
Cable length	10 m	10 m

Scope of delivery

Order no.	604113	604114
Float switch	■	■

Product advantages

- Mechanical seal for protection of the pump if the water is particularly dense or contains large particles
- For very coarse dirty water with solid bodies of up to Ø 50 mm
- Double mechanical seal with oil chamber for ideal protection of the pump if the water is very dirty
- Durable pump housing made of non-corrosive, high-quality stainless steel
- For drainage and pumping dry of construction pits, cellars and shafts. Also for pumping sewage and waste water in industrial and domestic environments.
- Self-cleaning Vortex-impeller to minimise blockages
- Designed for continuous mode with S1 motor operating mode
- Overload protection: protects the motor from overheating
- Float switch for automatic mode
- Suitable for mobile and stationary use thanks to ergonomic handles and stability

System components

Accessories → 559

01  
02  
03  
04  
05  
06  
07  
08  
09  
10  
11  
12  
13  
14  
15



Technical data	Garden Pump P 2000 G	Garden Pump P 3300 G	Garden Pump P 4000 G
Rated input power	450 W	900 W	1,100 W
Maximum delivery rate	2,000 l/h	3,300 l/h	4,000 l/h
Maximum delivery height	30 m	45 m	46 m
Maximum pressure	3 bar	4.5 bar	4.6 bar
Maximum suction height	8 m	8 m	8 m
Suction port	1" female thread	1" female thread	1" female thread
Discharge port	1" female thread	1" female thread	1" female thread
Pump housing	Grey cast iron	Grey cast iron	Grey cast iron
Drive shaft	Stainless steel	Stainless steel	Stainless steel
Number of impellers	1	1	1
Weight	7.6 kg	11.1 kg	12.2 kg
Cable length	1.5 m	1.5 m	1.5 m

#### Scope of delivery

Order no.	600962	600963	600964
Fabric sealing tape	■	■	■

#### Product advantages

- For garden irrigation with 1 or 2 sprinklers
- For garden irrigation with 1 or 2 sprinklers
- For garden irrigation with 1 to 3 sprinklers
- For garden irrigation and groundwater pumping as well as pumping, pumping empty, circulation of clear water
- Maintenance-free capacitor motor
- Overload protection: protects the motor from overheating
- High-quality slip seal system for long service life
- Separate water filling opening for simple operation of the pump
- Water drain plug (removable without tools) for protection in case of frost
- Rubberised feet for low-noise and low-vibration operation
- Ergonomic handle for comfortable transport

#### System components

Accessories → 561



Technical data	Garden Pump P 4500 Inox	Garden Pump P 6000 Inox
Rated input power	1,300 W	1,300 W
Maximum delivery rate	4,500 l/h	6,000 l/h
Maximum delivery height	48 m	55 m
Maximum pressure	4.8 bar	5.5 bar
Maximum suction height	8 m	8 m
Suction port	1" female thread	1" female thread
Discharge port	1" female thread	1" female thread
Pump housing	Stainless steel	Stainless steel
Drive shaft	Stainless steel	Stainless steel
Number of impellers	1	5
Weight	10.6 kg	12.7 kg
Cable length	1.5 m	1.5 m

#### Scope of delivery

Order no.	600965	600966
Fabric sealing tape	■	■

#### Product advantages

- For garden irrigation with 1 to 3 sprinklers
- Metabo pump protection: automatic dry-run protection with LED display to protect the pump and high user safety
- Multi-level pump running gear for high performance and low-noise operation
- For garden irrigation with 1 to 4 sprinklers
- For garden irrigation and groundwater pumping as well as pumping, pumping empty, circulation of clear water
- Maintenance-free capacitor motor
- Overload protection: protects the motor from overheating
- High-quality slip seal system for long service life
- Durable stainless steel pump housing
- Separate water filling opening for simple operation of the pump
- Water drain plug (removable without tools) for protection in case of frost
- Rubberised feet for low-noise and low-vibration operation
- Ergonomic handle for comfortable transport

#### System components

Accessories → 561



Technical data	Garden Pump P 9000 G
Rated input power	1,900 W
Maximum delivery rate	9,000 l/h
Maximum delivery height	51 m
Maximum pressure	5.1 bar
Maximum suction height	9 m
Suction port	1 1/4" female thread
Discharge port	1" female thread
Pump housing	Grey cast iron
Drive shaft	Stainless steel
Number of impellers	1
Weight	25.1 kg
Cable length	1.5 m

Scope of delivery	
Order no.	600967
Fabric sealing tape	■

- Product advantages**
- For garden irrigation and groundwater pumping as well as pumping, pumping empty, circulation of clear water
  - Maintenance-free capacitor motor
  - Overload protection: protects the motor from overheating
  - High-quality slip seal system for long service life
  - For garden irrigation with 1 to 6 sprinklers

**System components**

Accessories → 561

## Domestic Waterworks: Well Supplied.

With our domestic waterworks, you can supply water for flushing WCs, washing machines or other domestic appliances with free rain or well water - thus saving money. These powerful units will deliver a water supply at a pressure of up to 5.5 bar from their robust tank. The Metabo pump protection with dry-run protection offers maximum safety for man and machine. The initial operation of our complete systems is particularly easy: Filter and check valve are integrated in the compact design.



**Metabo pump protection**  
Automatic dry-run protection with LED display to protect the pump and for high user safety



**Overload protection**  
protects the motor from overheating

**Maintenance-free capacitor motor**

**High-quality mechanical seal system**  
for long service life

**Integrated filter**

**Integrated check valve**  
prevents running the pump dry when it is switched off, and for a short restart time during a new start

**Water drain plug (removable without tools)**  
for protection in case of frost

HWWI 4500/25 Inox



**Domestic Waterworks**  
For automatic water supply, for garden irrigation and groundwater pumping as well as pumping, pumping empty, circulation of clear water



**Automatic activation**  
Pressure switch for automatic activation of the domestic water system



**Integrated accessory**  
Filter and check valve protect the pump from dirt and ensure seamless operation.

01  
02  
03  
04  
05  
06  
07  
08  
09  
10  
11  
12  
13  
14  
15



Technical data	Domestic Waterworks HWW 3300/25 G	Domestic Waterworks HWW 3500/25 Inox
Rated input power	900 W	900 W
Maximum delivery rate	3,300 l/h	3,500 l/h
Maximum delivery height	45 m	45 m
Maximum pressure	4.5 bar	4.5 bar
Maximum suction height	8 m	8 m
Switch-on pressure approx.	1.4 bar	1.4 bar
Switch-off pressure approx.	3.2 bar	3.2 bar
Suction port	1" female thread	1" female thread
Discharge port	1" female thread	1" female thread
Tank capacity, approximately	24 l	24 l
Pump housing	Grey cast iron	Stainless steel
Drive shaft	Stainless steel	Stainless steel
Tank	Steel	Steel
Number of impellers	1	1
Weight	16.2 kg	14.6 kg
Cable length	1.5 m	1.5 m

**Scope of delivery**

Order no.	600968	600969
Check valve	■	■
Fabric sealing tape	■	■

**Product advantages**

- Durable stainless steel pump housing
- For automatic water supply, for garden irrigation and groundwater pumping as well as pumping, pumping empty, circulation of clear water
- Pressure vessel for energy-saving and low-noise provision of water
- Pressure switch for automatic activation of the domestic water system in case of increased water demand
- Maintenance-free capacitor motor
- Overload protection: protects the motor from overheating
- High-quality slip seal system for long service life
- Separate water filling opening for simple operation of the pump
- Water drain plug (removable without tools) for protection in case of frost
- For garden irrigation with 1 or 2 sprinklers
- For single phase alternating current

**System components**

Accessories → 561



Technical data	Domestic Waterworks HWW 4000/25 G	Domestic Waterworks HWW 4500/25 Inox	Domestic Waterworks HWW 4500/25 Inox Plus
Rated input power	1,100 W	1,300 W	1,300 W
Maximum delivery rate	4,000 l/h	4,500 l/h	4,500 l/h
Maximum delivery height	46 m	48 m	48 m
Maximum pressure	4.6 bar	4.8 bar	4.8 bar
Maximum suction height	8 m	8 m	8 m
Switch-on pressure approx.	1.4 bar	1.8 bar	1.8 bar
Switch-off pressure approx.	3.2 bar	3.6 bar	3.6 bar
Suction port	1" female thread	1" female thread	1" female thread
Discharge port	1" female thread	1" female thread	1" female thread
Tank capacity, approximately	24 l	24 l	24 l
Pump housing	Grey cast iron	Stainless steel	Stainless steel
Drive shaft	Stainless steel	Stainless steel	Stainless steel
Tank	Steel	Steel	Stainless steel
Number of impellers	1	1	1
Weight	17.2 kg	17.1 kg	16.2 kg
Cable length	1.5 m	1.5 m	1.5 m

**Scope of delivery**

Order no.	600971	600972	600973
Check valve	■	■	■
Fabric sealing tape	■	■	■

**Product advantages**

- Durable stainless steel pump housing
- Durable stainless steel pump housing and stainless steel tank
- For automatic water supply, for garden irrigation and groundwater pumping as well as pumping, pumping empty, circulation of clear water
- Pressure vessel for energy-saving and low-noise provision of water
- Pressure switch for automatic activation of the domestic water system in case of increased water demand
- Maintenance-free capacitor motor
- Overload protection: protects the motor from overheating
- High-quality slip seal system for long service life
- Separate water filling opening for simple operation of the pump
- Water drain plug (removable without tools) for protection in case of frost
- For garden irrigation with 1 to 3 sprinklers
- For single phase alternating current

**System components**

Accessories → 561

01  
02  
03  
04  
05  
06  
07  
08  
09  
10  
11  
12  
13  
14  
15



Technical data	Domestic Waterworks HWWI 3500/25 Inox	Domestic Waterworks HWWI 4500/25 Inox
Rated input power	1,100 W	1,300 W
Maximum delivery rate	3,500 l/h	4,500 l/h
Maximum delivery height	45 m	48 m
Maximum pressure	4.5 bar	4.8 bar
Maximum suction height	8 m	8 m
Switch-on pressure approx.	1.6 bar	1.6 bar
Switch-off pressure approx.	4.5 bar	4.8 bar
Suction port	1" female thread	1" female thread
Discharge port	1" female thread	1" female thread
Tank capacity, approximately	24 l	24 l
Pump housing	Stainless steel	Stainless steel
Drive shaft	Stainless steel	Stainless steel
Tank	Steel	Steel
Number of impellers	1	1
Weight	17.5 kg	17.8 kg
Cable length	1.5 m	1.5 m

**Scope of delivery**

Order no.	600970	600974
Fabric sealing tape	■	■
Filter key	■	■

**Product advantages**

- For garden irrigation with 1 or 2 sprinklers
- For garden irrigation with 1 to 3 sprinklers
- Complete system in compact design with integrated filter and check valve integrated as standard for easy installation
- For automatic water supply, for garden irrigation and groundwater pumping as well as pumping, pumping empty, circulation of clear water
- Pressure vessel for energy-saving and low-noise provision of water
- Electronic pressure switch for automatic activation of the domestic water system in case of increased water demand
- Metabo pump protection: automatic dry-run protection with LED display to protect the pump and high user safety
- Integrated, washable filter protects the pump from contamination
- Integrated check valve prevents dry running of the pump when it is switched off, enabling a short restart process
- Maintenance-free capacitor motor
- Overload protection: protects the motor from overheating
- High-quality slip seal system for long service life
- Durable stainless steel pump housing
- Separate water filling opening for simple operation of the pump
- Water drain plug (removable without tools) for protection in case of frost
- For single phase alternating current

**System components**

Accessories → 561



Technical data	Domestic Waterworks HWW 6000/25 Inox	Domestic Waterworks HWW 6000/50 Inox
Rated input power	1,300 W	1,300 W
Maximum delivery rate	6,000 l/h	6,000 l/h
Maximum delivery height	55 m	55 m
Maximum pressure	5.5 bar	5.5 bar
Maximum suction height	8 m	8 m
Switch-on pressure approx.	1.6 bar	1.6 bar
Switch-off pressure approx.	5.5 bar	5.5 bar
Suction port	1" female thread	1" female thread
Discharge port	1" female thread	1" female thread
Tank capacity, approximately	24 l	50 l
Pump housing	Stainless steel	Stainless steel
Drive shaft	Stainless steel	Stainless steel
Tank	Steel	Steel
Number of impellers	5	5
Weight	18.9 kg	22.1 kg
Cable length	1.5 m	1.5 m

**Scope of delivery**

Order no.	600975	600976
Check valve	■	■
Fabric sealing tape	■	■

**Product advantages**

- For automatic water supply, for garden irrigation and groundwater pumping as well as pumping, pumping empty, circulation of clear water
- Pressure vessel for energy-saving and low-noise provision of water
- Electronic pressure switch for automatic activation of the domestic water system in case of increased water demand
- Metabo pump protection: automatic dry-run protection with LED display to protect the pump and high user safety
- Multi-level pump running gear for high performance and low-noise operation
- Maintenance-free capacitor motor
- Overload protection: protects the motor from overheating
- High-quality slip seal system for long service life
- Durable stainless steel pump housing
- Separate water filling opening for simple operation of the pump
- Water drain plug (removable without tools) for protection in case of frost
- For garden irrigation with 1 to 4 sprinklers
- For single phase alternating current

**System components**

Accessories → 561

01  
02  
03  
04  
05  
06  
07  
08  
09  
10  
11  
12  
13  
14  
15



Technical data	Domestic Waterworks HWW 9000/100 G
Rated input power	1,900 W
Maximum delivery rate	9,000 l/h
Maximum delivery height	51 m
Maximum pressure	5.1 bar
Maximum suction height	9 m
Switch-on pressure approx.	1.5 bar
Switch-off pressure approx.	3.9 bar
Suction port	1 1/4" female thread
Discharge port	1" female thread
Tank capacity, approximately	100 l
Pump housing	Grey cast iron
Drive shaft	Stainless steel
Tank	Steel
Number of impellers	1
Weight	39.9 kg
Cable length	1.5 m

Scope of delivery	
Order no.	600977
Check valve	■
Fabric sealing tape	■

- Product advantages**
- For automatic water supply, for garden irrigation and groundwater pumping as well as pumping, pumping empty, circulation of clear water
  - Pressure vessel for energy-saving and low-noise provision of water
  - Pressure switch for automatic activation of the domestic water system in case of increased water demand
  - Maintenance-free capacitor motor
  - Overload protection: protects the motor from overheating
  - High-quality slip seal system for long service life
  - For garden irrigation with 1 to 6 sprinklers
  - For single phase alternating current

**System components**

Accessories → 561



Technical data	Automatic Domestic Water System HWA 3500 Inox	Automatic Domestic Water System HWA 4500 Inox	Automatic Domestic Water System HWA 6000 Inox
Rated input power	1,100 W	1,300 W	1,300 W
Maximum delivery rate	3,500 l/h	4,500 l/h	6,000 l/h
Maximum suction height	8 m	8 m	8 m
Maximum delivery height	45 m	48 m	55 m
Maximum pressure	4.5 bar	4.8 bar	5.5 bar
Switch-on pressure approx.	1.6 bar	1.6 bar	1.6 bar
Switch-off pressure approx.	4.5 bar	4.8 bar	5.5 bar
Suction port	1" female thread	1" female thread	1" female thread
Discharge port	1" female thread	1" female thread	1" female thread
Pump housing	Stainless steel	Stainless steel	Stainless steel
Drive shaft	Stainless steel	Stainless steel	Stainless steel
Number of impellers	1	1	5
Weight	10.6 kg	11.5 kg	13 kg
Cable length	1.5 m	1.5 m	1.5 m

Scope of delivery			
Order no.	600978	600979	600980
Check valve	■		■
Fabric sealing tape	■	■	■
Filter key		■	

- Product advantages**
- For garden irrigation with 1 or 2 sprinklers
  - Complete system in compact design with integrated filter and check valve integrated as standard for easy installation
  - Multi-level pump running gear for high performance and low-noise operation
  - Integrated, washable filter protects the pump from contamination
  - Integrated check valve prevents dry running of the pump when it is switched off, enabling a short restart process
  - For garden irrigation with 1 to 3 sprinklers
  - For garden irrigation with 1 to 4 sprinklers
- 
- For automatic water supply, for garden irrigation and groundwater pumping as well as pumping, pumping empty, circulation of clear water
  - Intelligent electronics for automatic appropriate and energy-saving modes
  - Metabo pump protection: automatic dry-run protection with LED display to protect the pump and high user safety
  - Maintenance-free capacitor motor
  - Overload protection: protects the motor from overheating
  - High-quality slip seal system for long service life
  - Durable stainless steel pump housing
  - Separate water filling opening for comfortable operation of the pump
  - Water drain plug (removable without tools) for protection in case of frost

**System components**

Accessories → 561





Technical data	Deep Well Pump TBP 4000 M	Deep Well Pump TBP 5000 M
Rated input power	750 W	1,000 W
Maximum delivery rate	3,800 l/h	5,000 l/h
Maximum delivery height	55 m	60 m
Maximum pressure	5.5 bar	6 bar
Maximum immersion depth	20 m	20 m
Discharge port	1" female thread	1" female thread
Pump housing	Stainless steel/plastic	Stainless steel
Pump diameter	98 mm	98 mm
Number of impellers	7	8
Weight	12 kg	12.2 kg
Cable length	22 m	22 m

Scope of delivery	0250400055	0250500050
Order no.	0250400055	0250500050

Product advantages	0250400055	0250500050
	<ul style="list-style-type: none"> <li>7-level pump running gear for particularly high pump capacity</li> <li>Pump housing made of stainless steel and impact-resistant plastic</li> </ul>	<ul style="list-style-type: none"> <li>8-level pump running gear for particularly high pump capacity</li> <li>Pump housing made of stainless steel</li> </ul>
	<ul style="list-style-type: none"> <li>Especially suitable for great depths, as in bore wells and shafts</li> <li>For garden irrigation and groundwater pumping, as well as pumping, pumping empty, pumping dry and circulation of clear water</li> <li>Overload protection: protects the motor from overheating</li> <li>Integrated check valve prevents dry running of the pump when it is switched off, enabling a short restart process</li> <li>Robust pump head with brass thread insert and fixing eyelets for the drain rope</li> <li>Suitable for bore wells of 100 mm Ø (4")</li> <li>22 m Connection cable for more immersion depth</li> </ul>	

System components

Accessories → 561

Multi-adapters

- For connecting submersible pumps or domestic waterworks to discharge, suction or garden hoses

	Order no.
<p><b>Multi-adapter, 1"</b> 1" Male x 1" nozzle x 3/4" Female x 3/4" nozzle</p>	0903018410*
<p><b>Multi-adapter, 1 1/4"</b> 1 1/4" Female x 1 1/2" nozzle x 1" Male x 1" nozzle Double nipple, 1 1/4" Male Thread</p>	0903061677*
<p><b>Multi-adapter, 1 1/2"</b> 1 1/2" Male x 2" nozzle x 1 1/4" Male x 1 1/2" nozzle</p>	0903061685*

Angle Connections with Multi-adapter

- For connecting submersible pumps to quick-action couplings or discharge, suction or garden hoses

	Order no.
<p><b>Angle connection with multi-adapter 1 1/4"</b> Angle connection: 1 1/4" male thread / 1 1/4" male thread Multi-adapter: 1 1/4" female thread, 1 1/4" nozzle, 1 1/4" male thread, 1" nozzle</p>	0903064846*
<p><b>Angle connection with multi-adapter 1 1/2"</b> Angle connection: 1 1/2" Male thread / 1 1/2" Male thread Multi-adapter: 1 1/2" female thread, 1 1/2" nozzle, 1 1/4" nozzle, 1" male thread</p>	0903064854*

Angle Connections





- For connecting submersible pumps to quick-action couplings or discharge, suction or garden hoses

	Order no.
<p><b>Angle connection, 1"</b> 1" IG x 1" IG / 1 1/4" AG</p>	0903019379*
<p><b>Angle connection 1 1/4"</b> 1 1/4" AG x 1 1/4" AG / 1" IG</p>	0903053143*
<p><b>Angle connection 1 1/2" stainless steel</b> 1 1/2" IG / 1 1/2" AG</p>	0903064838*
<p><b>Angle connection, 2" stainless steel</b> 2" IG / 2" AG</p>	628802000*



\*Self-service packaging

### Storz Coupling

- For the connection of dirty water submersible pumps to discharge hoses with C-Storz coupling

	Order no.
 <p><b>Storz coupling, 1 1/2"</b> C = 2" x 1 1/2" AG</p>	0903061375*
 <p><b>Storz coupling 1 1/2" with extension pipe 100 mm</b> Consisting of: Storz coupling, C=2" x 1 1/2" female thread Pipe nipple, 1 1/2" Male Thread x 1 1/2" Male Thread - 100 mm Suitable for: DP 28-10 S Inox</p>	628801000
 <p><b>Storz coupling 1 1/2" with extension pipe 300 mm</b> Consisting of: Storz coupling, C=2" x 1 1/2" female thread Pipe nipple, 1 1/2" Male Thread x 1 1/2" Male Thread - 300 mm Suitable for PS 17000 SN, PS 18000 SN</p>	0903019352
 <p><b>Storz coupling 2"</b> C = 2" x 2" AG</p>	628800000*

### Discharge Sets with Fittings

	Order no.
 <p><b>Discharge set 7 m</b>  <ul style="list-style-type: none"> <li>For the connection of all submersible pumps 1".1 1/4" and 1 1/2" with multi-adapter</li> <li>1" Discharge hose, black, with incorporated rigid PVC coil, buckling-proof and non-abrasive</li> <li>Also suitable for suction devices (e.g. air, dust, woodchips)</li> </ul> </p> <p>Consisting of: 1" Spiral hose Screwed hose connection 1 1/4" x 25 mm in brass Industrial stainless steel threaded hose clamp 20 - 32 mm</p> <p>Internal Ø: 25 mm Wall thickness: 2.5 mm Length: 7 m Operating pressure: 1.5 bar Bursting pressure: 5 bar Temperature resistance: -5 - 60 °C</p>	628821000
 <p><b>Discharge set: 15 m</b>  <ul style="list-style-type: none"> <li>For connecting all submersible pumps with Storz couplings C=2"</li> <li>2" Construction/industrial hose, high strength polyester thread, round woven, rubber-lined interior, corrosion-free, ozone-, decomposition- and mould-resistant</li> <li>Light alloy Storz couplings fixed in on both sides</li> <li>Couplings fixed in with special steel wire</li> </ul> </p> <p>Consisting of: 2" Industrial hose Storz couplings C=2" Cam distance: 66 mm</p> <p>Internal Ø: 52 mm Wall thickness: 2.4 mm Length: 15 m Operating pressure: 10 bar Burst pressure: 30 bar Temperature resistance: 0° to 60°</p>	0903061294

### Suction Hose Sets

- Suitable for drawing from wells, cisterns, ponds or streams
- 1" suction hose, transparent, with incorporated rigid PVC coil, buckling-proof and non-abrasive
- Strainer with shackle to attach a floating ball



#### Standard suction hose sets with brass fittings

- For connection to the suction side of all garden pumps and domestic water / automatic domestic waterworks with 1" female thread/male thread

	Order no.
 <p><b>Standard suction hose set, 4 m</b> Consisting of: 1" Suction hose Hose clamps, steel galvanised Brass connector, 1" female thread Brass double nipple, 1" male thread Brass hose nozzle/O-ring, 1" male thread Brass check valve, 1" female thread with strainer, special steel Internal Ø: 25 mm Wall thickness: 3.2 mm Bending radius: 100 mm Operating pressure / burst pressure: 6 bar / 18 bar Temperature resistance: 0° to 60° Water column (vacuum): 7 m</p>	0903061227
 <p><b>Standard suction hose set, 7 m</b> Consisting of: 1" Suction hose Hose clamps, steel galvanised Brass connector, 1" female thread Brass double nipple, 1" male thread Brass hose nozzle/O-ring, 1" male thread Brass check valve, 1" female thread with strainer, special steel Internal Ø: 25 mm Wall thickness: 3.2 mm Bending radius: 100 mm Operating pressure / burst pressure: 6 bar / 18 bar Temperature resistance: 0° to 60° Water column (vacuum): 7 m</p>	0903061235

#### Professional suction hose sets with brass fittings, heavy-duty version

- For connection to the suction side of all garden pumps and domestic water / automatic domestic water systems with 1" female thread



	Order no.
 <p><b>Professional suction hose set, 4 m</b> Consisting of: Suction pressure hose 1" Chuck jaw clamps, steel double galvanised Brass suction high pressure coupling, 1" nozzle Brass quick-action coupling, 1" male thread Brass hose nozzle/O-ring, 1" male thread Brass check valve, 1" female thread with strainer, special steel Internal Ø: 25 mm Wall thickness: 3.4 mm Bending radius: 112 mm Operating pressure / bursting pressure: 8 bar / 24 bar Temperature resistance: 0° to 65° Water column (vacuum): 9 m</p>	0903061200
 <p><b>Professional suction hose set, 7 m</b> Consisting of: Suction pressure hose 1" Chuck jaw clamps, steel double galvanised Brass suction high pressure coupling, 1" nozzle Brass quick-action coupling, 1" male thread Brass hose nozzle/O-ring, 1" male thread Brass check valve, 1" female thread with strainer, special steel Internal Ø: 25 mm Wall thickness: 3.4 mm Bending radius: 112 mm Operating pressure / bursting pressure: 8 bar / 24 bar Temperature resistance: 0° to 65° Water column (vacuum): 9 m</p>	0903061219

\*Self-service packaging



01  
02  
03  
04  
05  
06  
07  
08  
09  
10  
11  
12  
13  
14  
15

### Floating Intake

- Suitable for drawing from cisterns, ponds or streams
- Prevents the suction of dirt particles
- Water intake in the cleanest area, just below the water surface



	Order no.
 <p><b>Floating ball</b> For connection to standard and professional suction hose sets Floating ball PE / 2 eyelets, Ø 150 mm Special steel ring, VA</p>	0903061367
 <p><b>Floating intake</b> For connection to 1" spiral suction hoses Consisting of: Floating ball PE / 2 eyelets, Ø 150 mm Special steel ring, VA Hose clamp, steel galvanised Brass hose nozzle/O-ring, 1" male thread Brass check valve, 1" with strainer, special steel</p>	0903061359

### Pump Assembly Set

Pump assembly set MSS suction connector	
<ul style="list-style-type: none"> <li>■ All in one package with illustrated assembly instructions</li> <li>■ Filter to protect the pump and sprinkling systems from damage caused by sand and dirt particles, 28 bar burst pressure</li> <li>■ Return valve: prevents the water flowing back into wells or cisterns</li> <li>■ Ball valve (closed): prevents the water flowing back into wells or into the suction area during maintenance jobs, e.g. filter cleaning or pump disassembly</li> <li>■ Quick-action coupling as connection option for suction hose sets</li> <li>■ Seal strip: seals without hemp or sealing paste</li> </ul>	
 <p><b>Pump assembly set MSS 310 – HWA/ P</b>  <ul style="list-style-type: none"> <li>■ For mounting to the suction connector of all garden pumps and domestic water / automatic domestic water systems with 1" female thread</li> <li>■ Garden pumps and domestic water works automatic domestic water systems require a short filter due to their lower construction height</li> </ul> </p> <p>Manufactured length approx. 310 mm</p> <p>Consisting of:                      Filter for garden pumps, short, 1" brass female thread                      Washable filter insert, 80 my                      Brass double nipple, 1" Male Thread x 1" Male Thread                      Brass check valve, 1" female thread x 1" female thread                      Nickel-plated brass ball valve, 1" female thread x 1" female thread                      Brass quick-action coupling, 1" male thread                      Fabric sealing tape, 12 m roll                      Filter key for loosening the filter dome</p>	0903061260
 <p><b>Pump assembly set MSS 380 – HWW</b>  <ul style="list-style-type: none"> <li>■ For mounting to the suction connector of all domestic water works with 1" female thread</li> </ul> </p> <p>Manufactured length approx. 380 mm</p> <p>Consisting of:                      Filter for domestic waterworks, long, 1" brass female thread                      Washable filter insert, 80 my                      Brass double nipple, 1" Male Thread x 1" Male Thread                      Brass check valve, 1" female thread x 1" female thread                      Nickel-plated brass ball valve, 1" female thread x 1" female thread                      Brass quick-action coupling, 1" male thread                      Zinc-plated pipe nipple, 1" Male Thread x 1" Male Thread x 100 mm                      Fabric sealing tape, 12 m roll                      Filter key for loosening the filter dome</p>	0903061278

### Pump assembly set MSD discharge port

- All in one package with illustrated assembly instructions
- Ball drain cock with nozzle: connection option for a 3/4" garden hose
- Tap connector: alternative connection option of a system quick-action coupling
- Seal strip: seals without hemp or sealing paste

	Order no.	
 <p><b>Pump assembly set MSD 200 – HWW/P</b>  <ul style="list-style-type: none"> <li>■ For mounting on the discharge port of all garden pumps and domestic water works with 1" female thread</li> <li>■ With protective cap for the easy filling of the pump body with water (e.g. watering can)</li> </ul> </p> <p>Manufactured length approx. 200 mm</p> <p>Consisting of:                      Zinc-plated pipe nipple, 1" Male Thread x 1" Male Thread x 100 mm                      Zinc-plated T-piece, 1" female thread x 3/4" female thread x 1" female thread                      Brass, nickel-plated ball drain cock, 3/4" female thread x 1" male thread x 3/4" nozzle                      Cock connector, 1" female thread                      Brass quick-action coupling, 1" male thread                      Quick-action coupling, brass protective cap                      Fabric sealing tape, 12 m roll</p>	0903061251	01
 <p><b>Pump assembly set MSD 1000 – HWA</b>  <ul style="list-style-type: none"> <li>■ For mounting to the discharge port of all domestic waterworks with 1" Male Thread</li> <li>■ Wall mounting prevents leverage force from the water tap to the automatic domestic system</li> </ul> </p> <p>Pressure hose for flexible connection, 8 bar operating pressure, 24 bar burst pressure                      Manufactured length approx. 1,000 mm</p> <p>Consisting of:                      Pressure hose 1 m x 3/4"                      Steel galvanised chuck jaw clamps, 23-25 mm                      Brass angle hose connector 1" female thread x 3/4" nozzle                      Hose nozzle with brass O-ring 3/4" Male Thread x 3/4" nozzle                      Brass wall disc 3/4" female thread x 3/4" female thread                      Brass, nickel-plated ball drain cock, 3/4" female thread x 1" male thread x 3/4" nozzle                      Cock connector, 1" female thread                      Fabric sealing tape, 12 m roll</p>	0903061243	02 03 04 05 06 07 08

### Check valves

- For connecting to the suction pipe of all garden pumps and domestic waterworks /automatic domestic water systems
- Ensures smooth operation and short restart times in case of repeated starts
- Prevents the pump from running dry when switched off

	Order no.	
 <p><b>Brass check valve 1"</b> Connecting thread: 1" male thread x 1" female thread</p>	628803000*	12
 <p><b>Brass check valve, 1 1/4"</b> Connecting thread: 1 1/4" male thread / x 1 1/4" female thread</p>	628805000*	13

\*Self-service packaging

### Filters for Garden Pumps and Domestic Waterworks/Automatic Domestic Water Systems



- For connecting to the suction pipe of all garden pumps and domestic waterworks /automatic domestic water systems
- Garden pumps and domestic water works automatic domestic water systems require a short filter due to their lower construction height
- The filter protects the pump and sprinkling systems from damage by sand and dirt particles
- Housing and lid made from impact-resistant polypropylene
- Connections with brass female thread
- Temperature resistant from 0 to 60°C

	Order no.
 <p><b>Filter 1" short</b>                      Height: 190 mm                      Diameter: 120 mm                      Water throughput: 6,200 l/hour                      Burst pressure: 28 bar                      Operating pressure: 8 bar</p>	0903016450
 <p><b>Filter 1" short, with washable filter insert</b>                      ■ Delivery includes washable filter insert with nylon fabric 80 my, protects against ultra-fine sand and solid matter                       Height: 190 mm                      Diameter: 120 mm                      Water throughput: 6,200 l/hour                      Burst pressure: 28 bar                      Operating pressure: 8 bar</p>	0903050314
 <p><b>Filter 1 1/4" short, with washable filter insert</b>                      ■ Delivery includes washable filter insert with nylon fabric 80 my, protects against ultra-fine sand and solid matter                       Height: 190 mm                      Diameter: 120 mm                      Water throughput: 6,200 l/hour                      Burst pressure: 28 bar                      Operating pressure: 8 bar</p>	628816000
 <p><b>Filter 1" long</b>                      Height: 310 mm                      Diameter: 120 mm                      Water throughput: 6,400 l/hour                      Burst pressure: 28 bar                      Operating pressure: 8 bar</p>	0903009250
 <p><b>Filter 1" long, with washable filter insert</b>                      ■ Delivery includes washable filter insert with nylon fabric 80 my, protects against ultra-fine sand and solid matter                       Height: 310 mm                      Diameter: 120 mm                      Water throughput: 6,400 l/hour                      Burst pressure: 28 bar                      Operating pressure: 8 bar</p>	0903050306
 <p><b>Filter 1 1/4" long, with washable filter insert</b>                      ■ Delivery includes washable filter insert with nylon fabric 80 my, protects against ultra-fine sand and solid matter                       Height: 310 mm                      Diameter: 120 mm                      Water throughput: 6,400 l/hour                      Burst pressure: 28 bar                      Operating pressure: 8 bar</p>	628817000
 <p><b>Filter 1 1/2" long</b>                      Height: 310 mm                      Diameter: 120 mm                      Water throughput: 13,800 l/hour                      Burst pressure: 28 bar                      Operating pressure: 8 bar</p>	0903014253

### Filter Inserts





#### One-way filter insert

- Insert with twisted thread, 20 my
- Protects pump and sprinkling systems against damage by very fine sand and solid matter



	Connecting thread	Version	Order no.
	1"	Short	0903028432*
	1"	Long	0903028351*

#### Washable filter insert

- Washable insert with nylon fabric, 80 my
- Protects pump and sprinkling systems against damage by sand and solid matter



	Connecting thread	Version	Order no.
	1"	Short	0903028440*
	1 1/4"	Short	628818000*
	1"	Long	0903028360*
	1 1/4" + 1 1/2"	Long	0903028416*
	1"	Long	628804000*

### Filter Accessories

	Order no.
 <p><b>Filter key</b>                      ■ For the loosening of the filter dome                      Internal Ø, 120 mm</p>	0903058005*
 <p><b>Filter sealing set</b>                      Suitable for 1" and 1 1/2" filters                      Consisting of:                      1x Filter dome O-ring, Ø 88 x 3.5 mm                      1x Filter insert flat seal, Ø 52 x 40 x 4 mm                      2x Filter insert flat seal, Ø 52 x 27 x 4 mm</p>	0903061316*

\*Self-service packaging

Dry-run Protection



	Order no.
 <p><b>Hydromat HM 3 – electronic pressure switch with dry-run protection</b></p> <ul style="list-style-type: none"> <li>■ Automatic control: switch on the pump for water discharge and switch off upon reaching the maximum pressure</li> <li>■ Dry-run protection: automatic deactivation of the motor when nothing is left to pump (leaky suction pipe, the water supply dries out)</li> <li>■ LED display to check the operating condition</li> <li>■ Membrane and spring to eliminate the impact of pressure surges</li> <li>■ Safety valve to prevent water leaking if the diaphragm is damaged</li> <li>■ Quick and easy assembly</li> <li>■ Ideal for converting a garden pump into an automatic domestic water system</li> <li>■ Also suitable for deep well pumps and submersible pressure pumps</li> </ul> <p>Switch-on pressure approx. 1.5 bar Voltage: 115 V/ 230 V Frequency: 50 / 60 Hz Protection type: IP 65 Maximum amperage: 16(8) A-1.5 kW Maximum operating pressure 10 bar Maximum operating temperature 0° to 60° C Connection: Discharge port, 1" male thread Device connection, 1" male thread Brass adapter 1" female thread x 1" male thread</p>	628799000
 <p><b>Dry-run Protection Stop Switch</b></p> <ul style="list-style-type: none"> <li>■ Dry-run protection for domestic waterworks, automatic domestic water systems, garden pumps, submersible pumps and submersible pressure pumps</li> <li>■ Float switch with 10 metre cable length</li> <li>■ When drawing from cisterns, ponds or streams, the float switch switches the pumps on and off automatically depending on the water level</li> <li>■ Plug/socket combination</li> </ul>	0903028521

Armoured Hose

	Order no.
 <p><b>Armoured hose</b></p> <ul style="list-style-type: none"> <li>■ For connection to the suction/discharge side of all domestic waterworks / automatic domestic water systems with 1" male thread/female thread on permanently mounted pipes</li> <li>■ Absorbs running noises and guarantees high safety by means of double deep injection on the connection fittings</li> <li>■ Special steel jacket 1", interior latex core</li> <li>■ Rust-free fittings</li> </ul> <p>Consisting of: Armoured hose, 1" male thread x 1" female thread Gasket Ø 30 x 23 x 3 mm</p> <p>Internal Ø: 25 mm Wall thickness: 4 mm Length 500 mm Operating pressure: 6 bar Bursting pressure: 18 bar Temperature resistance: 0° to 65°</p>	0903061340*

Garden Sprinklers

- Multi-functional for cleaning and irrigation
- Sturdy metal version with disc handle and locking device
- Brass connection - compatible with all commercial plug-in systems
- Infinitely adjustable water volume via a separate rotating knob
- Water jet can be adjusted from a hard full jet to fine atomised spray
- Soft plastic ring on sprinkler head for protection against damage
- Hand valve with locking device

	Order no.
 <p><b>Shower spray SB 2</b></p> <ul style="list-style-type: none"> <li>■ Water jet infinitely adjustable from full hard jet to fine spray</li> </ul>	0903063122*
 <p><b>Garden sprinkler GB 7</b></p> <ul style="list-style-type: none"> <li>■ 7 Water jet shapes from full spray to fine atomised spray</li> </ul>	0903060778*
 <p><b>Stream lance GS 10</b></p> <ul style="list-style-type: none"> <li>■ 10 Water jet formats ranging from full spray to fine atomised spray</li> <li>■ Long reach, e.g. saves you having to step over beds</li> <li>■ Ideal for watering hanging flower arrangements</li> </ul> <p>Length: 920 mm</p>	0903063130*

Garden Sprinklers

	Order no.
 <p><b>Surface sprinkler FR 9</b></p> <ul style="list-style-type: none"> <li>■ Sturdy metal version for mobile and stationary use</li> <li>■ Removable dirt filter to protect the sprinkler from damage by sand and dirt particles</li> <li>■ Brass coupling plug, compatible with all commercial plug-in systems</li> <li>■ Multi-functional for watering surfaces or small front gardens</li> <li>■ 9 Sprinkler areas, from circle to rectangle to atomised spray</li> <li>■ Desired sprinkler area adjustable by turning the sprinkler disc</li> </ul> <p>Sprinkler surfaces: Circle Ø = maximum 10 m / 80 m<sup>2</sup> Semi-circle r = maximum 8 m / 100 m<sup>2</sup> Square maximum 8 x 8 m / 64 m<sup>2</sup> Rectangle maximum 16 x 2 m / 32 m<sup>2</sup></p> <p>Connection: Brass cap nut, 3/4" female thread Brass coupling plug 3/4" male thread</p>	0903063149

Fabric sealing tape

	Order no.
 <p><b>Fabric sealing tape</b></p> <ul style="list-style-type: none"> <li>■ Seals without hemp or sealing paste</li> <li>■ For metal and plastic threaded joints</li> </ul> <p>Length on roll: 12 m Width: 12 mm Thickness: 0.1 mm</p>	0901026319*

\*Self-service packaging

\*Self-service packaging

01  
02  
03  
04  
05  
06  
07  
08  
09  
10  
11  
12  
13  
14  
15

# M+ System: Machine and accessories perfectly synchronised for maximum performance.

Even during the development phase at Metabo, machines and accessories are optimally adjusted and tested to complement one another. Your added benefit: Maximum performance thanks to Metabo + System effect.

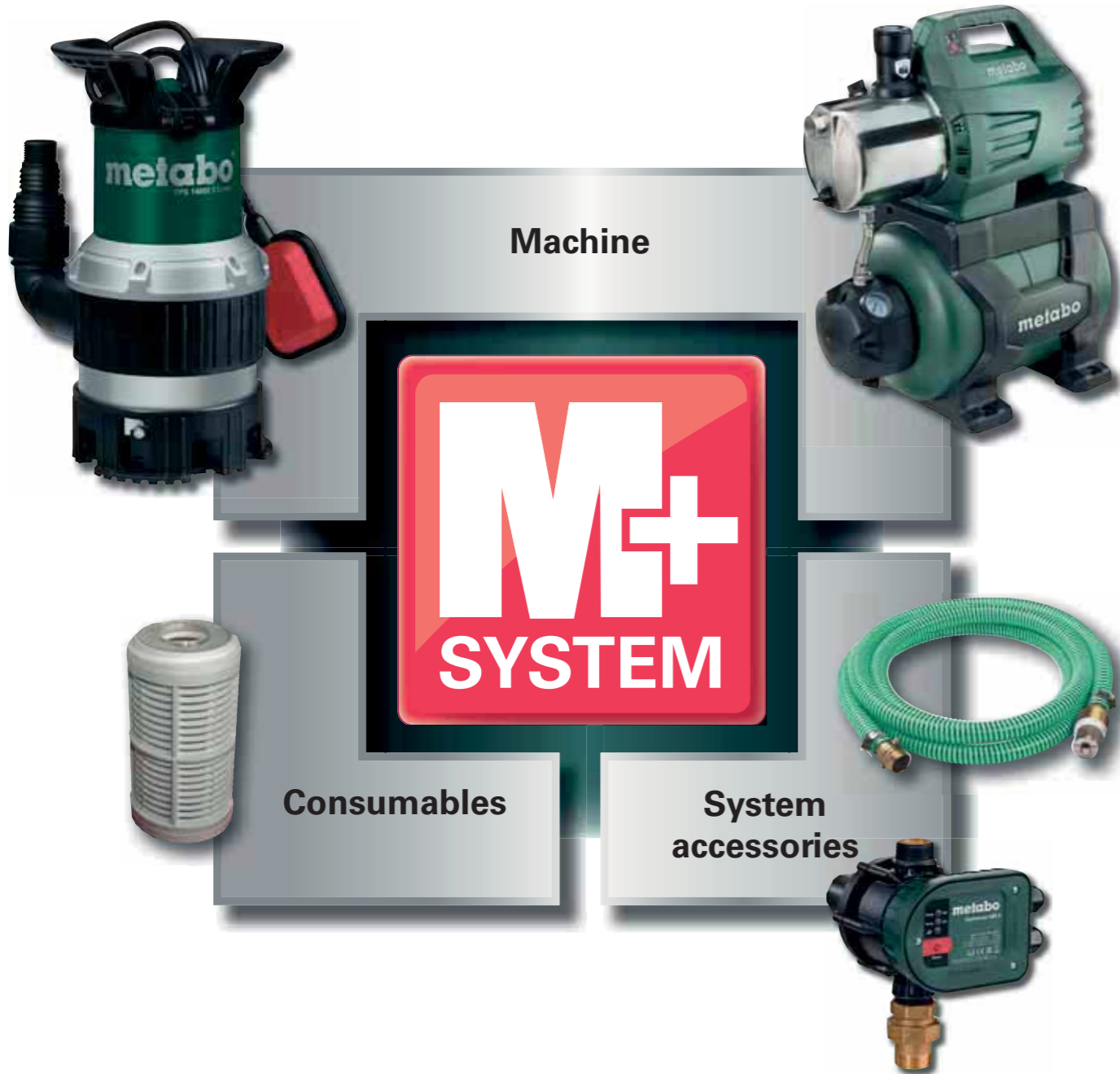

# Hedge Trimmers

# Hedge Trimmers: Light, quiet and powerful.

Metabo hedge trimmers have been setting standards in the market for decades. With patented handle systems, robust motors, high-quality blades and excellent ergonomics. They are always the right choice for the professional user. Whether mains-powered or as a cordless machine with intelligent battery pack technology: Metabo hedge trimmers are amongst the lightest machines on the market and offer maximum safety thanks to their quick stop function, safety clutch and trigger guard.



**Cable replacement cover (87 and 88 series)**  
Maintenance friendly!  
The mains cable can be easily replaced by an electrical technician, saving you time and money.

**Carbon brush replacement cover (88 series only)**  
Maintenance friendly!  
Carbon brushes can be easily replaced by an electrical technician, saving you time and money.

**Trigger guard**  
The extra large guard protects the user from debris and from kickback, for example, when snagging walls, tree trunks or rocks.

**Cable strain protection**  
Effectively prevents the power cord from disconnecting from the adapter of an extension cable.

**Optimum airflow (87 and 88 series)**  
The motor airflow exhausts downwards, thus preventing users from having air blown towards their eyes.

**Double reduction gearing**  
for especially high cutting performance

**Quick stop in 0.05 seconds**  
This kicks in when one of the two hand switches are not depressed, thus preventing you from accidentally touching the running blade.

**Metabo S-automatic safety clutch**  
Protects blades and gears when debris or large braches stop the blades

HS 8865



**Special blade geometry**  
Blades with improved geometry generate less wear and thus deliver 200% longer service life.



**More reach**  
Patented Metabo handle system with additional switch for up to 50% more reach.



**AHS 36 V / AHS 36-65 V**  
The lightest machines amongst professional hedge trimmers in the 36 V class.

18 V  
36 V



Technical data	Cordless Hedge Trimmer AHS 18-55 V	Cordless Hedge Trimmer AHS 36 V	Cordless Hedge Trimmer AHS 36-65 V
Type of battery pack	Li-Ion / LiHD	Li-Ion	Li-Ion
Battery pack voltage	18 V	36 V	36 V
Runtime per battery pack charge	70 min	85 min	85 min
Cutting thickness	18 mm	18 mm	18 mm
Cutting strength	53 cm	53 cm	63 cm
No of strokes (no load)	2,700 /min	2,700 /min	2,700 /min
Weight (including battery pack)	3.8 kg	3.9 kg	4.1 kg

Scope of delivery	600463	602177	602203
Order no.	600463	602177	602203
Li-Power battery pack (36 V/2.5 Ah)		■	
2 Li-Power battery packs (36 V/2.5 Ah)			■
2 LiHD battery packs (18 V/4.0 Ah)	■		
»AIR COOLED« quick charger ASC Ultra			■
Charger ASC 30-36 V »AIR COOLED«	■	■	
Storage slipcase	■	■	■

Equipment variants can be found in the Metabo price list and on the internet

**Product advantages**

- The lightest machines amongst professional hedge trimmers in the 36 V class
- Blades with special geometry generate less wear and thus deliver 200% longer service life
- Clean cut thanks to diamond-ground blade teeth on both sides at a 30° angle
- Lower safety blade for high safety at work
- Top cutting performance generated by double reduction gearing
- Pleasant to work with thanks to low-vibration running, perfect ergonomics and soft-grip handle
- Safety features include electronic blade quick stop (in 0.3 seconds)
- Trigger guard with twig feed protects user and gearing from kickbacks
- Battery packs with capacity display for checking the charge status

**System components**

Accessories → 575 | Battery packs → 72

01  
02  
03  
04  
05  
06  
07  
08  
09  
10  
11  
12  
13  
14  
15



Technical data	Hedge Trimmer HS 45	Hedge Trimmer HS 55	Hedge Trimmer HS 65
Cutting thickness	18 mm	18 mm	18 mm
Cutting strength	45 cm	55 cm	65 cm
Blade clearance	28 mm	28 mm	28 mm
No of strokes (no load)	3,100 /min	3,100 /min	3,100 /min
Rated input power	450 W	450 W	450 W
Weight (without mains cable)	3.4 kg	3.6 kg	3.8 kg
Cable length	0.3 m	0.3 m	0.3 m

**Scope of delivery**

Order no.	620016	620017	620018
Trigger guard	■	■	■
Container	■	■	■

**Product advantages**

- Patented mechanical blade quick stop (in 0.05 seconds) for improved safety
- Clean cut thanks to diamond-ground blade teeth on both sides at a 30° angle
- Lower safety blade for high safety at work
- Metabo S-automatic safety clutch: Protects blades and gears when debris or large branches stop the blades
- Cable strain relief prevents the unintentional disconnection of the plug-in connection
- Trigger guard with twig feed protects user and gearing from kickbacks

**System components**

Accessories → 575



Technical data	Hedge Trimmer HS 8745	Hedge Trimmer HS 8755	Hedge Trimmer HS 8765
Cutting thickness	20 mm	20 mm	20 mm
Cutting strength	45 cm	55 cm	65 cm
Blade clearance	34 mm	34 mm	34 mm
No of strokes (no load)	3,100 /min	3,100 /min	3,100 /min
Rated input power	560 W	560 W	560 W
Weight (without mains cable)	3.8 kg	3.9 kg	4 kg
Cable length	0.3 m	0.3 m	0.3 m

**Scope of delivery**

Order no.	608745	608755	608765
Trigger guard	■	■	■
Container	■	■	■

**Product advantages**

- Patented Metabo handle system with additional switch for up to 50% more reach and range
- Low weight avoids fatigue when working
- Patented mechanical blade quick stop (in 0.05 seconds) for improved safety
- Blades with special geometry generate less wear and thus deliver 200% longer service life
- Clean cut thanks to diamond-ground blade teeth on both sides at a 30° angle
- Lower safety blade for high safety at work
- Metabo S-automatic safety clutch: Protects blades and gears when debris or large branches stop the blades
- Fatigue-proof operation due to ergonomic full grip bow-type handle design and optimum centre of gravity position
- Very quiet running due to shear blades running in opposite direction
- User-friendly guidance of machine exhaust in all working situations
- Easy servicing thanks to cable replacement cover
- Cable strain relief prevents the unintentional disconnection of the plug-in connection
- Trigger guard with twig feed protects user and gearing from kickbacks

**System components**

Accessories → 575





Technical data	Hedge Trimmer HS 8855	Hedge Trimmer HS 8865	Hedge Trimmer HS 8875
Cutting thickness	26 mm	26 mm	26 mm
Cutting strength	55 cm	65 cm	75 cm
Blade clearance	34 mm	34 mm	34 mm
No of strokes (no load)	2,900 /min	2,900 /min	2,900 /min
Rated input power	660 W	660 W	660 W
Weight (without mains cable)	4.1 kg	4.2 kg	4.4 kg
Cable length	0.3 m	0.3 m	0.3 m

Scope of delivery

Order no.	608855	608865	608875
Trigger guard	■	■	■
Container	■	■	■

Product advantages

- Double reduction gearing for particularly high cutting performance
- Patented Metabo handle system with additional switch for up to 50% more reach and range
- Low weight avoids fatigue when working
- Patented mechanical blade quick stop (in 0.05 seconds) for improved safety
- Blades with special geometry generate less wear and thus deliver 200% longer service life
- Clean cut thanks to diamond-ground blade teeth on both sides at a 30° angle
- Lower safety blade for high safety at work
- Metabo S-automatic safety clutch: Protects blades and gears when debris or large branches stop the blades
- Fatigue-proof operation due to ergonomic full grip bow-type handle design and optimum centre of gravity position
- Very quiet running due to shear blades running in opposite direction
- User-friendly guidance of machine exhaust in all working situations
- Particularly easy to service thanks to carbon brush and cable replacement cover
- Cable strain relief prevents the unintentional disconnection of the plug-in connection
- Trigger guard with twig feed protects user and gearing from kickbacks

Accessories for Hedge Trimmers

Hedge trimmer maintenance oil

- Based on natural oil, biodegradable

		Order no.
	<b>Hedge trimmer maintenance oil spray</b> Pump-spray-can, with 0.3 litre capacity Sales unit: 1 Packing unit: 6	630475000
	<b>Hedge trimmer maintenance oil 1 ltr</b> Sales unit: 1 Packing unit: 6	630474000

Accessories for Chain Saws

Saw chains

		Order no.
	<b>Saw chain</b> For Kt 1441; division: 3/8" ; drive links: 57	631670000*
	<b>Saw chain</b> For Kt 1440; division: 3/8" ; drive links: 59	631435000*

## MetaLoc

- Extremely robust, unbreakable boxes with a wide carrying handle
- Accomodating order system inside the box...
  - the right accessories are always at hand for the right tool
  - special inserts for storing accessories and small parts
- .... and from box to box
  - boxes can be stacked and linked
  - clear storage system in the workshop, in the car, anywhere
- Numerous possible uses, e.g. with individually configurable foam inserts (accessories)
- The MetaLoc stays in shape – even at extreme temperatures (-40° to +90°C)
- No protruding parts, and thus no danger of getting snagged, e.g. on construction sites

## MetaLoc



**MetaLoc II**  
Dimensions: 396 x 296 x 157.5 mm

	Order no.
<b>MetaLoc II</b> MetaLoc II, empty, without inserts	626431000
<b>MetaLoc II</b> Suitable for SRE 4350/ 4351 TurboTec	626442000
<b>MetaLoc II</b> Suitable for all cordless drills / screwdrivers and cordless hammer drills	626446000
	626449000



**MetaLoc II**  
with perforated foam insert



**MetaLoc III**  
Dimensions: 396 x 296 x 210 mm

	Order no.
<b>MetaLoc III</b> empty MetaLoc III, without inserts	626432000
<b>MetaLoc III</b> Suitable for SXE 425/ 450 TurboTec	626436000



**MetaLoc IV**  
Dimensions: 396 x 296 x 315 mm

	Order no.
<b>MetaLoc IV</b> empty MetaLoc IV, without inserts	626433000
<b>MetaLoc IV</b> Suitable for KS 55 FS, KSE 55 Vario, KS 66 Plus, KS 68 Plus	626438000

## Accessories for the MetaLocs

**Metadepot**

- For practical storage of pipes, cables and accessories.
- Provides the combination of Metabo all-purpose vacuum cleaners with the MetaLoc system
- Numerous possible uses, e.g. with individually configurable foam inserts (accessories)
- The MetaLoc stays in shape – even at extreme temperatures (-40° to +90°C)

suitable for: ASR 2025, ASR 2050, SHR 2050 M, ASR 25 L SC , ASR 50 L SC, ASR 50 M SC  
Sales unit: 1

**Trolley AS 18 L PC / MetaLoc**

- For greatest safety and flexibility, MetaLoc and cordless vacuum cleaners AS 18 L PC can be locked in situ.
- Two lockable castors ensure excellent mobility

suitable for: AS 18 L PC and MetaLoc  
Sales unit: 1

## Plastic Carry Cases

## Plastic carry cases MC 10 / MC 20



- A plastic carry case made from particularly strong material and robust metal fasteners that guarantee a long service life of the case.
- Optimised handle position for carrying of two carry cases with the same hand.
- Optional extension of the case by the accessory boxes "PlusBox R" and "PlusBox L" (accessories). Up to 2 Plus Boxes can be attached to the sides of the carry case.

	Order no.
<b>Plastic carry case MC 20 neutral</b> Plastic carry case with perforated foam insert for individual customisation. Suitable for Metabo drills and impact drills, cordless drill/screwdriver, cordless hammer drill, rotary hammers, combination hammers, multi hammers (2-3 kg class), all Metabo angle grinders (mains or cordless) up to disks - 125 mm Ø, paint remover, jigsaws, screwdrivers, etc Dimensions: 495 x 320 x 132 mm	623854000
<b>Plastic carry case MC 20 WS</b> Plastic carry case suitable for all Metabo angle grinders up to disc Ø 125 mm. Dimensions: 495 x 320 x 132 mm	623857000
<b>Plastic carry case MC 10 battery pack BS / battery pack SB</b> Plastic carry case suitable for all cordless drill/screwdrivers, cordless hammer drills and cordless impact drivers Dimensions: 495 x 320 x 112 mm	623855000
<b>Plastic carry case MC 10 BH/SB</b> Plastic carry case suitable for all rotary hammers, combination hammers (except KHE 3250 and KHE 3251), multi hammers (2-3 kg class) and all impact drills Dimensions: 495 x 320 x 112 mm	623856000
<b>Plastic carry case MC 10 STE</b> Plastic carry case suitable for all Metabo jigsaws with aluminium die-cast gear housing Dimensions: 495 x 320 x 112 mm	623858000

Accessory boxes for carry case MC 10 / MC 20



- Plastic accessory box for individual storage of diverse accessories.
- Optional extension of tool machine case MC 10 and MC 20
- Up to 2 Plus Boxes can be attached to the sides of the carry case.
- Equipped with three partitions and wall mounting as standard



	Order no.
<b>PlusBox L</b> Especially for fixing on the left side of the case Dimensions: 116 x 320 x 112 mm	623851000
<b>PlusBox R</b> Especially for fixing on the right side of the case Dimensions: 116 x 320 x 112 mm	623852000



More Plastic Carry Cases



	Order no.
 <b>Plastic carry case</b> Plastic carry case suitable for all Metabo angle grinders with disc Ø 180 mm and 230 mm Dimensions: 175 x 730 x 315 mm	625451000

Sheet Steel Carry Cases





	Order no.
 <b>Metal carry case</b> For all angle grinders with grinding wheel Ø of 180 mm and 230 mm Dimensions: 170 x 675 x 275 mm	623874000
 <b>Metal carry case</b> For planer Ho 0882 Dimensions: 195 x 395 x 285 mm	631382000

Tool Bags

- Comfortable side pads and padded shoulder strap
- Three reflective Metabo logos for optimum visibility on the construction site
- Stable, integrated base plate with strips to protect the bag contents
- Material: water-repellent and tear-proof 600D polyester

	Order no.
 <b>Tool bag (small)</b> <ul style="list-style-type: none"> <li>■ Robust and compact tool bag</li> <li>■ 3 bag compartments on the inside with hook and loop straps for 2 battery packs and 1 charger</li> <li>■ Spacious bag with zipper on the outside and 2 other small bags at the top.</li> <li>■ with hook and loop for quick access</li> <li>■ Dimensions (l x w x h): 460 x 260 x 280 mm</li> </ul>	657006000
 <b>Tool bag (large)</b> <ul style="list-style-type: none"> <li>■ Large, practical tool bag</li> <li>■ 5 bag compartments on the inside with hook and loop straps for 3 battery packs, 1 charger and for accessories</li> <li>■ 2 spacious bags with zipper on the outside and 3 other small bags for quick access</li> <li>■ Dimensions (l x w x h): 670 x 290 x 325 mm</li> </ul>	657007000

## Safety goggles

		Sales unit / sales display	Order no.
	<b>Protective goggles</b> <ul style="list-style-type: none"> <li>Perfect all-round protection, large field of vision thanks to specially shaped lens</li> <li>Excellent ventilation thanks to optimally designed side arms</li> <li>Special coating (outside scratch-proof, inside anti-fog)</li> <li>Lens colourless, UV 2 - 1.2</li> </ul>	1 piece / 5 pieces 	623751000*
	<b>Protective goggles</b> <ul style="list-style-type: none"> <li>Perfect all-round protection, large field of vision thanks to specially shaped lens</li> <li>Excellent ventilation thanks to optimally designed side arms</li> <li>Special coating (outside scratch-proof, inside anti-fog)</li> <li>Grey lens, UV 5 - 2.5</li> </ul>	1 piece / 5 pieces 	623752000

## Working gloves M1



	<ul style="list-style-type: none"> <li>Tailored protective glove</li> <li>Finish made from easy-grip, soft Amara leather on the palm, high degree of flexibility and grip</li> <li>Protection from mechanical stress</li> <li>Abrasion-proof, breathable</li> <li>Does not contain any substances known to cause allergies</li> <li>DIN EN 388 (2121)</li> </ul>		
			Order no.
Working gloves M1, size 9			623757000*
Working gloves M1, size 10			623758000*

## Working gloves M2

	<ul style="list-style-type: none"> <li>Ideally shaped 5-finger knitted glove made from PA/Spandex, palm coated in black Nitrile/PU</li> <li>Breathable</li> <li>Excellent safe grip</li> <li>Does not contain any substances known to cause allergies</li> <li>DIN EN 388 (3131)</li> </ul>		
			Order no.
Working gloves M2, size 9			623759000*
Working gloves M2, size 10			623760000*



## Bit box, 9 pieces

- Bits made from chrome vanadium steel (S2 quality); bits with colour coding: for quick and easy finding of the right bit; high-quality, robust box
- Magnetic bit holder

	comprising	Sales unit / sales display	Order no.
	S2-Bits, L = 25 mm (8 pieces): <ul style="list-style-type: none"> <li>PH1, PH2</li> <li>PZ1, PZ2</li> <li>SL5.5</li> <li>H4</li> <li>T20, T25</li> </ul> 1 x magnetic bit holder	1 piece / 21 pieces 	630419000



## Bit box, 15 pieces

- Bits made from chrome vanadium steel (S2 quality); bits with colour coding: for quick and easy finding of the right bit; high-quality, robust box
- Magnetic quick change adapter

	comprising:	Sales unit / sales display	Order no.
	S 2-bits L= 25 mm (14 pieces): <ul style="list-style-type: none"> <li>PH1, PH2</li> <li>PZ1, PZ2</li> <li>SL4, SL6</li> <li>H3, H4, H5</li> <li>T10, T15, T20, T25, T30</li> </ul> 1 x magnetic quick-change bit holder	1 piece / 24 pieces 	626703000



## Bit box and ratchet set, 26 pieces

- Bits made from chrome vanadium steel (S2 quality); bits with colour coding: for quick and easy finding of the right bit; high-quality, robust box
- High-quality ratchet; socket wrench made from chrome vanadium steel

	comprising:	Sales unit / sales display	Order no.
	S 2-bits L= 25 mm (18 pieces): <ul style="list-style-type: none"> <li>PH1, PH2, PH3</li> <li>PZ1, PZ2, PZ3</li> <li>SL4, SL5.5, SL6.5</li> <li>H3, H4, H5, H6</li> <li>T10, T15, T20, T25, T30</li> </ul> Socket wrenches (6 pieces) 1/4", 6 mm, 7 mm, 8 mm, 10 mm, 13 mm; 1 x extension 1 x ratchet	1 piece / 12 pieces 	626701000



Bit box, 29 pieces

- Bits made from chrome vanadium steel (S2 quality); bits with colour coding: for quick and easy finding of the right bit; magnetic quick-change adapter; high-quality, robust box with extendable Euro hole punch

comprising:		Sales unit / sales display	Order no.
	S 2-bits L= 25 mm (21 pieces): ⊕ PH1x1, PH2x2, PH3x1 ⊕ PZ1x1, PZ2x2, PZ3x1 ⊖ SL3x1, SL5x1 ⊖ H3x1, H4x1, H5x1, H6x1 ⊕ T10x1, T15x1, T20x2, T25x1, T30x1, T40x1	L = 50 mm (6 pieces): ⊕ PH2x1 ⊕ PZ2x1 ⊕ T20x1, T25x1 ⊖ SL4x1 ⊖ H4x1  1 x adapter 1 x magnetic quick-change bit holder	1 piece / 12 pieces    626710000



Bit box, 29 pieces + mini flashlight

- Bits made from chrome vanadium steel (S2 quality); bits with colour coding: for quick and easy finding of the right bit; magnetic quick-change adapter; high-quality, robust box with extendable Euro hole punch; including mini flashlight: CREE-LED, 100 lumen, luminous range 100 m, duration of illumination 180 min

comprising:		Sales unit / sales display	Order no.
	S 2-bits L= 25 mm (21 pieces): ⊕ PH1x1, PH2x2, PH3x1 ⊕ PZ1x1, PZ2x2, PZ3x1 ⊖ SL3x1, SL5x1 ⊖ H3x1, H4x1, H5x1, H6x1 ⊕ T10x1, T15x1, T20x2, T25x1, T30x1, T40x1	L = 50 mm (6 pieces): ⊕ PH2x1 ⊕ PZ2x1 ⊕ T20x1, T25x1 ⊖ SL4x1 ⊖ H4x1  1 x adapter 1 x magnetic quick-change bit holder 1 x Mini flash light	1 piece / 12 pieces    626721000



Bit box, 32 pieces

- Bits made from chrome vanadium steel (S2 quality); bits with colour coding: for quick and easy finding of the right bit; high-quality, robust box
- Magnetic quick change adapter
- With adapter for sockets (socket wrench inserts)

comprising:		Sales unit / sales display	Order no.
	S 2-bits L= 25 mm (30 pieces): ⊕ PH1, PH2x2, PH3 ⊕ PZ1, PZ2x2, PZ3 ⊖ SL3, SL4, SL5, SL6 ⊖ H3, H4, H5, H6 ⊕ T10, T15, T20, T25, T27, T30, T40 ⊕ T10, T15, T20, T25, T27, T30, T40	1 x adapter 1 x magnetic quick-change bit holder 65 mm	1 piece / 12 pieces    626700000



Bit box, 32 pieces, Torx

- Bits made from chrome vanadium steel (S2 quality); bits with colour coding: for quick finding of the right bit; high-quality, robust box
- Magnetic quick change adapter

comprising:		Sales unit / sales display	Order no.
	S 2 bits, L = 25 mm ⊕ T10 x 3; T15 x 3; T20 x 6 ⊕ T25 x 6; T27 x 3; T30 x 6; T40 x 4	1 x magnetic bit holder 65 mm    1 piece / 12 pieces	626709000



Bit box, 56 pieces

- Bits made from chrome vanadium steel (S2 quality); bits with colour coding: for quick and easy finding of the right bit; high-quality, robust box
- Magnetic quick change adapter

comprising:		Sales unit / sales display	Order no.
	S2-Bits, L = 25 mm (48 pieces): ⊕ PH1 x 3, PH2x3, PH3x3 ⊕ PZ1x3, PZ2x3, PZ3x3 ⊖ SL4x2, SL5x2, SL6x2 ⊖ H3, H4, H5 ⊕ T10x2, T15x2, T20x2, T25x2, ⊕ T27x2, T30x2, T40x2 ⊕ T10, T15, T20, T25, T27, T30, T40	L = 75 mm (7 pieces): ⊕ PH2, PH3 ⊕ PZ1, PZ2 ⊖ SL6 ⊕ T20, T25  1 x magnetic quick-change bit holder	1 piece / 12 pieces    626702000



Bit box, 71 pieces

- Bits made from chrome vanadium steel (S2 quality); bits with colour coding: for quick and easy finding of the right bit; high-quality, robust box
- Magnetic quick change and bit holder



comprising:		Sales unit / sales display	Order no.
	S2-Bits, L = 25 mm (60 pieces): ⊕ PH1 x 3, PH2x6, PH3x3 ⊕ PZ1x3, PZ2x6, PZ3x3 ⊖ SL4x3, SL6x3 ⊖ H4x3, H5x3, H6x3 ⊕ T10x3, T15x3, T20x3, T25x3, T27x3, T30x3, T40x3	L = 75 mm (9 pieces): ⊕ PH1, PH2, PH3 ⊕ PZ1, PZ2 ⊖ SL4, SL6 ⊕ T20, T25  1 x magnetic quick-change bit holder 1 x magnetic bit holder	1 piece / 6 pieces    626704000

Bit box PZ2, 25 pieces



- Bits made from chrome vanadium steel (S2 quality); bits with colour coding: high-quality, robust box, with Euro hole punch

comprising:	Sales unit / sales display	Order no.
 <p>S2 bits, L = 25 mm (25 pieces):                      ⚙ PZ2</p>	 <p>1 piece / 12 pieces</p>	626711000

Bit box T20, 25 pieces

comprising:	Sales unit / sales display	Order no.
 <p>S2 bits, L = 25 mm (25 pieces):                      ⚙ T20</p>	 <p>1 piece / 12 pieces</p>	626712000

Bit box T25, 25 pieces

comprising:	Sales unit / sales display	Order no.
 <p>S2 bits, L = 25 mm (25 pieces):                      ⚙ T25</p>	 <p>1 piece / 12 pieces</p>	626713000



Bit roll-up case, 7 pieces

- Bits made from chrome vanadium steel (S2 quality); bits with colour coding: for quick and easy finding of the right bit

comprising:	Sales unit / sales display	Order no.
 <p>S2 bits, L = 89 mm (6 pieces):                      ⚙ PH2                      ⚙ PZ1, PZ2                      ⚙ SL5.5                      ⚙ T20, T25</p> <p>1 x Screwdriver handle</p>	 <p>1 piece / 12 pieces</p>	626723000



Bit roll-up case, 30 pieces

- Bits made of chrome vanadium steel (S2 quality); bits with colour coding: for faster and simpler detection of the suitable bit

comprising:	Sales unit / sales display	Order no.
 <p>S2 bits, L = 25 mm (16 pieces):                      ⚙ PH1, PH2x2, PH3                      ⚙ PZ1, PZ2x2, PZ3                      ⚙ SL3, SL5.5                      ⚙ T15, T20 x 2, T25 x 2, T30</p> <p>L = 50 mm (7 pieces):                      ⚙ PH2                      ⚙ PZ1, PZ2                      ⚙ SL3                      ⚙ T20, T25                      ⚙ H4</p>	 <p>1 piece / 12 pieces</p>	626726000



Drill Bit roll-up case, 35 pieces

- Bits made from chrome vanadium steel (S2 quality); bits with colour coding: for quick and easy finding of the right bit; HSS-G metal drill bit, ground version, cylindrical, DIN 338, type N, 135° crosswise grinding. Wood spiral drill bit made of high-grade chrome vanadium steel, hardened, with centering point, for use in hard and soft wood, plywood, chipboards etc.

comprising:	Sales unit / sales display	Order no.
 <p>HSS-G metal drill bits (6 pieces)                      Ø 3 mm, Ø 4 mm, Ø 5 mm, Ø 6 mm, Ø 8 mm, Ø 10 mm</p> <p>Wood drill bits (6 pieces):                      Ø 3 mm, Ø 4 mm, Ø 5 mm, Ø 6 mm, Ø 8 mm, Ø 10 mm</p>	 <p>1 piece / 12 pieces</p>	626725000



Accessory set in carry case, 55 pieces

- High-quality, robust box

comprising:	Sales unit / sales display	Order no.
 <p>HSS-TIN metal drill bits (14 pieces):                      Ø 1.5 mm x 2; Ø 2 mm x 2; Ø 2.5 mm;                      Ø 3 mm x 2; Ø 3.5 mm; Ø 4 mm; Ø 4.5 mm;                      Ø 5 mm; Ø 5.5 mm; Ø 6 mm; Ø 6.5 mm</p> <p>Carbide masonry drill bit (7 pieces):                      Ø 4 mm; Ø 5 mm; Ø 6 mm x 2; Ø 7 mm;                      Ø 8 mm; Ø 10 mm</p> <p>CV wood drill bit (5 pieces):                      Ø 4 mm, Ø 5 mm, Ø 6 mm, Ø 8 mm,                      Ø 10 mm</p> <p>Flat wood drill bit (2 pieces):                      Ø 16 mm; Ø 22 mm</p>	 <p>1 piece / 6 pieces</p>	626707000



Accessory set in carry case, 86 pieces

- High-quality, robust box

comprising:	Sales unit / sales display	Order no.
 <p>HSS-TiN metal drill bit (14 pieces):                      Ø 1.5 mm x 2, Ø 2 mm x 2, Ø 2.5 mm, Ø 3 mm x 2, Ø 3.5 mm, Ø 4 mm, Ø 4.5 mm, Ø 5 mm, Ø 5.5 mm, Ø 6 mm, Ø 6.5 mm</p> <p>Carbide masonry drill bit (7 pieces):                      Ø 4 mm, Ø 5 mm, Ø 6 mm x 2, Ø 7 mm, Ø 8 mm, Ø 10 mm</p> <p>CV wood drill bit (5 pieces):                      Ø 4 mm, Ø 5 mm, Ø 6 mm, Ø 8 mm, Ø 10 mm</p> <p>Flat wood drill bit (4 pieces):                      Ø 12 mm, Ø 16 mm, Ø 19 mm, Ø 25 mm</p> <p>S2-Bits, L = 25 mm (32 pieces):                      PH0, PH1 x 2, PH2 x 2, PH3 x 2                      PZ0, PZ1 x 2, PZ2 x 2, PZ3 x 2                      SL3, SL4 x 2, SL6 x 2, SL7                      H3, H4, H5 x 2, H6                      T10, T15 x 2, T20 x 2, T25, T30</p> <p>L = 50 mm (8 Stück):                      PH1, PH2, PH3                      PZ1, PZ2, PZ3                      T15, T20</p> <p>Depth guide sleeve (4 pieces)                      3 mm, 5 mm, 8 mm, 10 mm</p> <p>Socket wrenches (8 pieces)                      5 mm, 6 mm, 7 mm, 8 mm, 9 mm, 10 mm, 11 mm, 12 mm</p> <p>1 x countersink (wood)                      1 x magnetic bit holder                      1 x Ø ruler                      1 x Allen key</p>	 1 piece / 6 pieces	626708000



Wood drill bit storage case, 8 pieces

- In high-quality, robust plastic cassette with extendable Euro hole punch
- Wood spiral drill bit made of high-grade chrome vanadium steel, hardened, with centering point. For use in hard and soft wood, plywood, chipboards, etc.



comprising:	Sales unit / sales display	Order no.
 <p>Ø 3 mm, Ø 4 mm, Ø 5 mm, Ø 5.5 mm, Ø 6 mm, Ø 7 mm, Ø 8 mm, Ø 10 mm</p>	 1 piece / 10 pieces	626705000

Masonry drill bit storage case, 8 pieces



- In high-quality, robust plastic cassette with extendable Euro hook tab.
- Carbide masonry drill bit for drills and impact drills, milled version, suitable for drilling bricks, masonry, etc.

comprising:	Sales unit / sales display	Order no.
 <p>Ø 3 mm, Ø 4 mm, Ø 5 mm, Ø 5.5 mm, Ø 6 mm, Ø 7 mm, Ø 8 mm, Ø 10 mm</p>	 1 piece / 10 pieces	626706000

Drill bit assortment roll-up case, 13 pieces

comprising:	Sales unit / sales display	Order no.
 <p>Metal drill bit HSS-G (5 pieces):                      1 x Ø 4 x 62 mm, 2 x Ø 5 x 75 mm, 1 x Ø 6 x 92 mm, 1 x Ø 8 x 117 mm</p> <p>Wood drill bit (4 pieces):                      1 x Ø 4 x 74 mm, 1 x Ø 5 x 85 mm, 1 x Ø 6 x 92 mm, 1 x Ø 8 x 117 mm</p> <p>Masonry drill bit (4 pieces):                      1 x Ø 4 x 75 mm, 1 x Ø 5 x 85 mm, 1 x Ø 6 x 100 mm, 1 x Ø 8 x 120 mm</p>	 1 piece / 9 pieces	626728000

Drill bit assortment roll-up case, 20 pieces

comprising:	Sales unit / sales display	Order no.
 <p>Metal drill bit HSS-G (8 pieces):                      2 x Ø 3 x 62 mm, 2 x Ø 4 x 62 mm, 1 x Ø 5 x 75 mm, 1 x Ø 6 x 92 mm, 1 x Ø 8 x 117 mm, 1 x Ø 10 x 135 mm</p> <p>Wood drill bits (6 pieces):                      1 x Ø 3 x 62 mm, 1 x Ø 4 x 74 mm, 1 x Ø 5 x 85 mm, 1 x Ø 6 x 92 mm, 1 x Ø 8 x 117 mm, 1 x Ø 10 x 133 mm</p> <p>Masonry drill bit (6 pieces):                      1 x Ø 3 x 60 mm, 1 x Ø 4 x 75 mm, 1 x Ø 5 x 85 mm, 1 x Ø 6 x 100 mm, 1 x Ø 8 x 120 mm, 1 x Ø 10 x 120 mm</p>	 1 piece / 9 pieces	626729000

SDS-plus storage case, 4 pieces

- 4 pieces, in plastic storage case
- SDS-plus drill bit with high-quality carbide drill tip
- Dynamic, chisel-shaped bit head
- Large-volume S-spiral geometry ensures quick drill dust removal
- Good drilling output with good tool life
- For use in concrete, masonry, natural stone



	Diameter mm	Length mm	Sales unit / sales display	Order no.
	Ø 5, 6, 8, 10	160	1 piece / 10 pieces	625580000

SDS-plus classic drill bit/chiselling bit set, 10 pieces

- SDS-plus drill bit with high-quality carbide drill tip
- Dynamic, chisel-shaped bit head
- Large-volume S-spiral geometry ensures quick drill dust removal
- Good drilling output with good tool life
- For use in concrete, masonry, natural stone

Diameter mm	Length mm	Sales unit / sales display	Order no.
Ø 5, 5.5, 6, 7, 8	160	1 piece / 10 pieces	630824000
Ø 10, 12, 14	210		

Pointed chisel, L = 250 mm  
Flat chisel, Ø 20 x 250 mm





**NEW**

SDS-plus chisel set , 2 pieces

- Comprising: 1 pointed chisel L = 200 mm, 1 x flat chisel 20 x 200 mm
- For general chiselling and demolition work of masonry, concrete and loose stones.



Sales unit / sales display	Order no.
1 piece / 6 pieces	630486000

SDS-max chisel set, 2 pieces

- Comprising: 1 pointed chisel L = 360 mm, 1 x flat chisel 25 x 360 mm
- For general chiselling and demolition work of masonry, concrete and loose stones.

Sales unit / sales display	Order no.
1 piece / 6 pieces	623309000

HSS-R drill bit storage case

- Metal drill bits, HSS-R, roll-milled version, cylindrical, type N, 118° cone-shaped, shell polished surface, in metal case
- suitable for drilling holes in steel, NF metals, cast steel, alloyed and non-alloyed; up to 900 N/mm<sup>2</sup> tensile strength



Diameter x bore mm	Version	Sales unit / sales display	Order no.
1-10 x 0.5	19 pieces	1 piece / 6 pieces	627151000
1-13 x 0.5	25 pieces	1 piece / 4 pieces	627152000



HSS-G drill bit storage case

- HSS-G Metal drill bits, ground version, cylindrical, DIN 338, type N, 135° crosswise grinding, blank surface, in metal case
- Suitable for drilling holes in steel and cast steel, alloyed and unalloyed, grey cast iron, malleable cast iron, ductile cast iron, sintered iron, nickel silver, graphite, non-ferrous metals, plastic; Up to 900 N/mm<sup>2</sup> tensile strength.

Diameter x bore mm	Version	Sales unit / sales display	Order no.
1-10 x 0.5	19 pieces	1 piece / 6 pieces	627153000
1-13 x 0.5	25 pieces	1 piece / 4 pieces	627154000

HSS-TiN drill bit storage case

- Metal drill bits, HSS-TiN, titanium nitrate alloy version, ground, cylindrical, type N, 135° crosswise grinding, gold-coloured surface, in metal case. HSS-TiN drill bit not suitable for processing aluminium!
- Ø 1-10 x 0.5 mm; Suitable for drilling holes in steel and cast steel, alloyed and unalloyed, grey cast iron, non-ferrous metals, plastic; up to 900 N/mm<sup>2</sup> tensile strength.

Diameter x bore mm	Version	Sales unit / sales display	Order no.
1-10 x 0.5	19 pieces	1 piece / 6 pieces	627156000



HSS-CO drill bit storage case

- Metal drill bits, HSS-CO, cobalt alloy version, ground, cylindrical, type N, 135° crosswise grinding, bronze surface, 19 pieces, in metal case
- Ø 1 - 10 x 0.5 mm; Suitable for drilling holes in steel, VA-steel, cast steel, non-ferrous metals, plastics, special alloys; up to 1100 N/mm<sup>2</sup> tensile strength

Diameter x bore mm	Version	Sales unit / sales display	Order no.
1-10 x 0.5	19 pieces	1 piece / 6 pieces	627157000





**Geared chuck with SDS-plus adapter**

- Geared chuck: 1.5 - 13 mm; 1/2" - 20 UNF; SDS-plus adapter with 1/2" - 20 UNF male thread, chuck key
- For use on rotary hammers with SDS plus holder; for clamping of straight shank drills, tools with straight shaft



NEW

Sales unit / sales display  
1 piece / 6 pieces  
Order no.  
626724000



**Cutting discs Inox, TF 41, in tin**

- Universal disc for processing steels/stainless steels
- Low in iron, sulphur and chlorine (Fe + S + Cl ≤ 0.1 %)
- Good cutting performance with good tool life.
- Low material consumption, power-saving, low machine load.



Quality class	Diameter x thickness x bore	Version	Maximum speed	Sales unit / packing unit	Order no.
A 60 R	115 x 1 x 22.23 mm	straight	13,200 /min	1 / 10 pieces	616358000
A 60 R	125 x 1 x 22.23 mm	straight	13,200 /min	1 / 10 pieces	616359000
A 60 R	125 x 1 x 16 mm	straight	13,200 /min	1 / 10 pieces	616364000



**Diamond cutting discs "Universal", segmented**

- For general construction/building site materials such as concrete, exposed aggregate concrete, hard sandstone, clay tiles.
- Sintered diamond segments
- Segment height: 7.0 mm
- Maximum working speed: 80 m/s



Diameter x bore	Segment width	Maximum speed	Sales unit / sales display	Order no.
115 x 22.23 mm	7 mm	13,300 /min	1 piece / 10 pieces	624306000
125 x 22.23 mm	7 mm	12,200 /min	1 piece / 10 pieces	624307000
150 x 22.23 mm	7 mm	10,200 /min	1 piece / 10 pieces	624308000
180 x 22.23 mm	7 mm	8,500 /min	1 piece / 10 pieces	624309000
230 x 22.23 mm	7 mm	6,600 /min	1 piece / 10 pieces	624310000



**Jigsaw blade assortment, 10-piece, for wood+metal+plastic**

- Suitable for Metabo, AEG, Atlas Copco, Black & Decker, Bosch, DeWalt, Elu, Festo, Hitachi, Holz-Her, Kress, Makita, Skil etc.
- For wood, metal and plastics
- Consisting of 623646000, 623634000, 623631000 x 2, 623633000 x 2, 623632000, 623639000, 623638000, 623637000
- Corresponds to: T119BO, T101B, T119B x 2, T144D x 2, T111C, T127D, T118B, T118A



Material suitability  
wood, metal, plastics  
Sales unit / sales display  
1 piece / 10 pieces  
Order no.  
623599000



**Router assortment, 6 pieces**



comprising:  
Straight bit (2 pieces):  
Ø 8 mm; Ø 12 mm;  
Rounding-over bit with ball bearing (1 piece):  
Ø 21.8 mm, R 6.3 mm  
Core box bit (1 piece):  
Ø 12.7 mm, R 6.3 mm;  
Multi-radius ogee bit with ball bearing (1 piece):  
Ø 25 mm, R 4.5 mm  
V straight bit (1 piece):  
Ø 12.7 mm 14°  
Sales unit / sales display  
1 piece / 6 pieces  
Order no.  
631040000

**Router assortment, 15 pieces**



comprising:  
Straight bit (4 pieces):  
Ø 6 mm; Ø 10 mm; Ø 12 mm; Ø 16 mm  
Core box bit (3 pieces):  
Ø 12.7 mm, R 6.3 mm; Ø 9.5 mm, R 4.8 mm;  
Ø 21.8 mm, R 6.3 mm  
Chamfer/bevelling tool (1 piece):  
Ø 31.5 mm, 45°  
V straight bit (1 piece):  
Ø 12.7 mm, 90°  
Rounding-over bits (2 pieces):  
Ø 28.1 mm, R 9.5 mm;  
Ø 21.8 mm, R 6.3 mm  
Bevelling tool (1 piece):  
Ø 12.7 mm  
Dovetailing bit (1 piece):  
Ø 12.7 mm, 14°  
Multi-radius ogee bit (1 piece):  
Ø 25 mm, R 4.5 mm  
Rebating bit (1 piece):  
Ø 22.2 mm  
Sales unit / sales display  
1 piece / 6 pieces  
Order no.  
631039000

# Accessory modules: Well thought out in detail.

The high quality of the Metabo accessory program, plus an optimal presentation warrant a successful and lucrative accessory business.



- Attractive sales modules for high-turnover product areas, e.g. drills, hole saws, jigsaw blades
- Lockable sales cabinets for drills
- Clear product information with colour system on the head bands
- Behind the hinged head band, clear article designation with EAN Code, Order No., dimensions and price range. Thus quick identification of product and reordering without problem.

- Flexible hook system and safe fit of the products
- Presentation option on any wall, in the Metabo accessory presentation system or counter display
- Always within the visual focus of the customer
- Self service vendor system

## Drill Bit Modules, module size 49 x 60 x 36 cm

**Metal drill bit, HSS-G**  
Standard components 144 pieces  
Order no. 690073000

Ø x GL mm	Units	Order no.
1.0 x 34	5	627950000
1.5 x 40	5	627951000
2.0 x 49	5	627952000
2.5 x 57	5	627953000
3.0 x 61	10	627954000
3.2 x 65	5	627955000
3.5 x 70	5	627957000
4.0 x 75	10	627958000
4.2 x 75	5	627960000
4.5 x 80	5	627961000
4.8 x 86	5	627962000
5.0 x 86	10	627963000
5.5 x 93	5	627966000
6.0 x 93	10	627967000
6.5 x 101	5	627968000
6.8 x 109	3	627969000
7.0 x 109	5	627970000
7.5 x 109	3	627971000
8.0 x 117	10	627973000
8.5 x 117	5	627975000
9.0 x 125	3	627976000
9.5 x 125	3	627977000
10.0 x 133	5	627978000
10.5 x 133	2	627980000
11.0 x 142	2	627981000
11.5 x 142	2	627982000
12.0 x 151	2	627983000
12.5 x 151	2	627984000
13.0 x 151	2	627985000

**Metal drill bits, HSS-Co**  
Standard components 168 pieces  
Order no. 690074000

Ø x GL mm	Units	Order no.
1.0 x 34	10	627430000
1.5 x 40	5	627431000
2.0 x 49	10	627432000
2.5 x 57	5	627433000
3.0 x 61	10	627435000
3.2 x 65	10	627436000
3.3 x 65	10	627437000
3.5 x 70	5	627438000
4.0 x 75	10	627439000
4.2 x 75	5	627441000
4.5 x 80	5	627442000
4.8 x 86	5	627443000
5.0 x 86	10	627444000
5.5 x 93	5	627447000
6.0 x 93	10	627448000
6.5 x 101	5	627449000
7.0 x 109	5	627451000
7.5 x 109	3	627452000
8.0 x 117	10	627454000
8.5 x 117	5	627456000
9.0 x 125	3	627457000
9.5 x 125	3	627458000
10.0 x 133	5	627459000
10.2 x 133	2	627460000
10.5 x 133	2	627461000
11.0 x 142	2	627462000
11.5 x 142	2	627463000
12.0 x 151	2	627464000
12.5 x 151	2	627465000
13.0 x 151	2	627466000



**Concrete drill bit »pro«**  
Standard components 93 pieces  
Order no. 690083000

Ø x GL mm	Units	Order no.
4.0 x 75	5	627224000
5.0 x 85	10	627225000
5.5 x 85	3	627226000
6.0 x 100	10	627227000
6.5 x 100	3	627228000
7.0 x 100	5	627229000
8.0 x 120	10	627230000
9.0 x 120	3	627389000
10.0 x 120	10	627391000
11.0 x 150	2	627392000
12.0 x 150	3	627393000
13.0 x 150	2	627394000
14.0 x 150	2	627395000
15.0 x 150	2	627396000
16.0 x 150	2	627399000
18.0 x 160	2	627409000
20.0 x 160	2	627410000
5.0 x 150	3	627421000
6.0 x 150	3	627423000
8.0 x 200	3	627426000
10.0 x 200	3	627427000
12.0 x 200	3	627428000
14.0 x 200	2	627429000

**Concrete drill bit »classic«**  
Standard components 93 pieces  
Order no. 690084000

Ø x GL mm	Units	Order no.
4.0 x 75	5	627625000
5.0 x 85	10	627626000
5.5 x 85	3	627627000
6.0 x 100	10	627646000
6.5 x 100	3	627650000
7.0 x 100	5	627651000
8.0 x 120	10	627652000
9.0 x 120	3	627653000
10.0 x 120	10	627654000
11.0 x 150	2	627655000
12.0 x 150	3	627656000
13.0 x 150	2	627657000
14.0 x 150	2	627658000
15.0 x 150	2	627659000
16.0 x 150	2	627661000
18.0 x 160	2	627662000
20.0 x 160	2	627664000
5.0 x 150	3	627665000
6.0 x 150	3	627675000
8.0 x 200	3	627679000
10.0 x 200	3	627697000
12.0 x 200	3	627698000
14.0 x 200	2	627699000

**SDS-Plus drill bit, pro 4**  
Standard components 120 pieces  
Order no. 690086000

Ø x GL mm	Units	Order no.
5.0 x 110	5	631820000
5.0 x 160	5	631821000
6.0 x 110	10	631824000
6.0 x 160	10	631825000
6.0 x 210	5	631826000
8.0 x 110	5	631832000
8.0 x 160	10	631833000
8.0 x 210	5	631834000
8.0 x 260	3	631835000
10.0 x 110	10	631837000
10.0 x 160	10	631838000
10.0 x 210	5	631839000
10.0 x 260	2	631840000
10.0 x 310	2	631841000
12.0 x 160	5	631844000
12.0 x 210	5	631845000
12.0 x 260	2	631846000
14.0 x 160	5	631849000
14.0 x 210	3	631850000
14.0 x 260	2	631851000
14.0 x 310	2	631852000
16.0 x 160	5	631854000
16.0 x 210	2	631855000
16.0 x 310	2	631856000

**SDS Plus drill bit, pro 4 "PREMIUM"**  
Standard components 160 pieces  
Order no. 690424000

Ø x GL mm	Units	Order no.
5.0 x 110	5	626200000
5.0 x 160	5	626201000
5.5 x 110	3	626202000
5.5 x 160	3	626203000
6.0 x 110	8	626204000
6.0 x 160	8	626205000
6.0 x 210	8	626206000
6.0 x 260	8	626207000
6.0 x 310	3	626208000
6.5 x 160	3	626209000
6.5 x 210	3	626210000
6.5 x 260	3	626211000
7.0 x 110	3	626213000
7.0 x 160	3	626214000
8.0 x 110	8	626215000
8.0 x 160	8	626216000
8.0 x 210	8	626217000
8.0 x 260	8	626218000
10.0 x 110	8	626219000
10.0 x 160	8	626220000
10.0 x 210	8	626221000
10.0 x 260	8	626222000
10.0 x 310	5	626223000
12.0 x 160	5	626225000
12.0 x 210	5	626226000
12.0 x 260	3	626227000
12.0 x 310	3	626228000
14.0 x 160	3	626230000
14.0 x 210	3	626231000
14.0 x 310	3	626232000

Drill Bit Modules, module size 49 x 60 x 36 cm

**Universal Wood Drill Bits**  
Standard components 126 pieces  
Order no. 690076000

Ø x GL mm	Units	Order no.
4.0 x 85	5	627680000
5.0 x 85	5	627681000
6.0 x 100	10	627683000
6.0 x 150	10	627684000
8.0 x 120	5	627688000
8.0 x 250	5	627689000
10.0 x 120	3	627691000
10.0 x 250	3	627692000
12.0 x 150	3	627693000
12.0 x 250	3	627694000
3.0 x 61	5	627986000
4.0 x 75	5	627987000
5.0 x 86	5	627988000
6.0 x 93	10	627989000
7.0 x 109	3	627990000
8.0 x 117	10	627991000
9.0 x 120	2	627992000
10.0 x 133	10	627993000
11.0 x 142	2	627994000
12.0 x 151	6	627995000
13.0 x 151	2	627996000
14.0 x 151	4	627997000
15.0 x 160	2	627998000
16.0 x 160	4	627999000
18.0 x 180	2	627339000
20.0 x 200	2	627340000

**Flat timber drill bits, wood drill bits, Forstner drill bits**  
Standard components 92 pieces  
Order no. 690080000

Ø x GL mm	Units	Order no.
10.0 x 160	3	627312000
12.0 x 160	3	627313000
14.0 x 160	3	627315000
16.0 x 160	3	627316000
18.0 x 160	3	627317000
20.0 x 160	3	627319000
25.0 x 160	3	627322000
26.0 x 160	3	627323000
30.0 x 160	3	627325000
36.0 x 160	3	627327000
3.0 x 61	5	627986000
4.0 x 75	5	627987000
5.0 x 86	5	627988000
6.0 x 93	5	627989000
8.0 x 117	5	627991000
10.0 x 133	5	627993000
12.0 x 151	3	627995000
14.0 x 151	3	627997000
16.0 x 160	3	627999000
18.0 x 180	3	627339000
10.0 x 90	2	627579000
12.0 x 90	2	627580000
14.0 x 90	2	627581000
15.0 x 90	2	627582000
20.0 x 90	2	627585000
25.0 x 90	2	627588000
26.0 x 90	2	627589000
30.0 x 90	2	627591000
35.0 x 90	2	627594000
36.0 x 90	2	627595000



**Forstner Drill Bit**  
Standard components 45 pieces  
Order no. 690081000

Ø x GL mm	Units	Order no.
10.0 x 90	3	627579000
12.0 x 90	3	627580000
14.0 x 90	3	627581000
15.0 x 90	3	627582000
16.0 x 90	3	627583000
18.0 x 90	3	627584000
20.0 x 90	3	627585000
22.0 x 90	2	627586000
24.0 x 90	2	627587000
25.0 x 90	2	627588000
26.0 x 90	2	627589000
28.0 x 90	2	627590000
30.0 x 90	2	627591000
32.0 x 90	2	627592000
34.0 x 90	2	627593000
35.0 x 90	2	627594000
36.0 x 90	2	627595000
38.0 x 90	2	627596000
40.0 x 90	2	627597000

**Auger Bits**  
Standard components 78 pieces  
Order no. 690078000

Ø x GL mm	Units	Order no.
8.0 x 230	3	627124000
10.0 x 230	5	627125000
12.0 x 230	5	627126000
14.0 x 230	5	627127000
16.0 x 230	5	627128000
18.0 x 230	2	627129000
20.0 x 230	2	627130000
22.0 x 230	2	627131000
24.0 x 230	2	627132000
26.0 x 230	2	627133000
28.0 x 230	2	627134000
30.0 x 230	2	627135000
32.0 x 230	2	627136000
8.0 x 460	3	627137000
10.0 x 460	5	627138000
12.0 x 460	5	627139000
14.0 x 460	5	627140000
16.0 x 460	5	627141000
18.0 x 460	2	627142000
20.0 x 460	2	627143000
22.0 x 460	2	627144000
24.0 x 460	2	627145000
26.0 x 460	2	627146000
28.0 x 460	2	627147000
30.0 x 460	2	627148000
32.0 x 460	2	627150000

**Concrete »classic«, wood HSS-G drill bits**  
Standard components 134 pieces  
Order no. 690085000

Ø x GL mm	Units	Order no.
4.0 x 75	5	627625000
5.0 x 85	5	627626000
6.0 x 100	5	627646000
6.0 x 150	5	627675000
8.0 x 120	5	627652000
8.0 x 200	5	627679000
10.0 x 120	5	627654000
12.0 x 150	3	627656000
14.0 x 150	3	627658000
16.0 x 160	3	627661000
3.0 x 61	5	627986000
4.0 x 75	5	627987000
5.0 x 86	5	627988000
6.0 x 93	5	627989000
8.0 x 117	5	627991000
10.0 x 133	5	627993000
12.0 x 151	3	627995000
14.0 x 151	3	627997000
16.0 x 160	3	627999000
18.0 x 180	3	627339000
3.0 x 61	5	627954000
3.5 x 70	5	627957000
4.0 x 75	5	627958000
4.5 x 80	5	627961000
5.0 x 86	5	627963000
5.5 x 93	5	627966000
6.0 x 93	5	627967000
6.5 x 101	5	627968000
8.0 x 117	5	627973000
10.0 x 133	3	627978000

**Flat timber drill bits, glass drill bits**  
Standard components 75 pieces  
Order no. 690077000

Ø x GL mm	Units	Order no.
8.0 x 160	3	627311000
10.0 x 160	3	627312000
12.0 x 160	3	627313000
13.0 x 160	3	627314000
14.0 x 160	3	627315000
16.0 x 160	3	627316000
18.0 x 160	3	627317000
19.0 x 160	3	627318000
20.0 x 160	6	627319000
22.0 x 160	3	627320000
24.0 x 160	3	627321000
25.0 x 160	3	627322000
26.0 x 160	3	627323000
28.0 x 160	3	627324000
30.0 x 160	3	627325000
32.0 x 160	3	627326000
36.0 x 160	3	627327000
38.0 x 160	3	627328000
(Verl.) 270	3	627329000
4.0 x 65	3	627243000
5.0 x 65	3	627244000
6.0 x 65	3	627245000
8.0 x 65	3	627246000
10.0 x 65	3	627247000

Drill bit cabinets HSS-R



**Drill bit cabinet, small**  
■ In the smallest of spaces (37.5 x 23.5 x 20.5 cm) the most important and most powerful HSS drill bits, roll-milled version

Contents	Order no.
29 dimensions with a total of 490 bits: Ø 1.0–13.0 mm, 0.5 mm ascending, in addition Ø 3.2 mm, 4.2 mm, 4.8 mm, 6.8 mm	690103000



**Drill bit cabinet, large**  
■ The most important and most powerful HSS bits, roll-milled version

Contents	Order no.
98 dimensions with a total of 945 drill-bits: Ø 1.0–13.0 mm, 0.1 mm ascending, additional Ø 10.2 mm	690106000

Drill bit cabinets HSS-G



**Drill bit cabinet, small**  
■ In the smallest of spaces (37.5 x 23.5 x 20.5 cm) the most important and most powerful HSS drill bits, ground version

Contents	Order no.
29 dimensions with total 410 bits: Ø 1.0 - 13.0 mm: 0.5 mm ascending in addition Ø 3.2 mm, 4.2 mm, 4.8 mm, 6.8 mm	690104000

Hole Saw Module



Jigsaw Blade Module



Jigsaw Blade Module



**HSS Bi-metal Hole Saws**  
Standard components 58 pieces  
Order no. 690425000

Designation	Ø mm	Pieces	Order no.
	19	2	625163000
	20	2	625164000
	25	2	625168000
	29	2	625170000
	32	2	625172000
	35	2	625174000
	38	2	625176000
	40	2	625177000
	44	2	625180000
	51	2	625184000
	57	2	625188000
	60	2	625190000
	64	2	625191000
	68	2	625194000
	76	2	625197000
	83	2	625199000
	95	2	625203000
Pilot drill, (6.35 mm)		8	625220000
adapter SW9 (14-30 mm)		8	625215000
adapter SW11 (32-152 mm)		8	625216000

**Small jigsaw blade module**  
Standard components 180 pieces  
Order no. 690101000

Corresponding Bosch type	Use-able length mm	Tooth pitch mm	Units	Order no.
T 119 BO	50	1.2	10	623646000
T 119 B	50	2	10	623631000
T 111 C	75	3	10	623632000
T 144 D	75	4	10	623633000
T 244 D	75	4	10	623649000
T 101 D	75	4	10	623635000
T 101 B	75	2.5	10	623634000
T 301 CD	85	3	10	623654000
T 234 X	90	progr.	10	623675000
Assortment			10	623645000
T 118 G	50	0.7	10	623636000
T 118 A	50	1.2	10	623637000
T 118 B	50	2	10	623638000
T 127 D	75	3	10	623639000
T 118 AF	50	1.2	10	623971000
T 318 A	100	1.2	10	623629000
T 123 X	75	progr.	10	623676000
T 345 XF	105	progr.	10	623677000

**Large jigsaw blade module**  
Standard components 270 pieces  
Order no. 690105000

Corresponding Bosch type	Use-able length mm	Tooth pitch mm	Units	Order no.
T 119 BO	50	1.2	10	623646000
T 119 B	50	2	10	623631000
T 111 C	75	3	10	623632000
T 144 D	75	4	10	623633000
T 244 D	75	4	10	623649000
T 144 DP	75	4	10	623694000
T 101 D	75	4	10	623635000
T 101 BR	75	2.5	10	623650000
T 101 B	75	2.5	10	623634000
T 101 AO	50	1.35	10	623651000
T 301 CLF	105	3	10	623977000
T 301 CD	85	3	10	623654000
T 234 X	90	progr.	10	623675000
Assortment			10	623645000
T 118 G	50	0.7	10	623636000
T 118 A	50	1.2	10	623637000
T 218 A	50	1.2	10	623647000
T 118 B	50	2	10	623638000
T 127 D	75	3	10	623639000
T 101 A	75	2	10	623640000
T 118 AF	50	1.2	10	623971000
T 118 EF	50	1.5	10	623972000
T 118 BF	50	2	10	623973000
T 127 DF	75	3	10	623974000
T 318 A	100	1.2	10	623629000
T 123 X	75	progr.	10	623676000
T 345 XF	105	progr.	10	623677000

Order No.	Page	Order No.	Page	Order No.	Page	Order No.	Page	Order No.	Page	Order No.	Page
600065	341	600441	340	600713	281	601163	41	601568	513	602191	27
600066	339	600442	340	600724	370	601204	376	601569	518	602192	32
600079	19	600443	336	600737	365	601205	468	601570	518	602193	27
600080	19	600444	336	600738	365	601206	58	601571	518	602198	37
600093	20	600448	111	600776	62	601207	58	601572	519	602200	32
600103	361	600463	63	600777	62	601229	366	601573	519	602203	71
600129	336	600464	119	600780	242	601230	103	601574	515	602204	314
600131	336	600465	111	600781	241	601231	105	601575	515	602205	37
600132	226	600468	112	600782	242	601232	103	601576	515	602206	24
600133	226	600472	120	600783	243	601233	105	601577	516	602207	24
600136	361	600476	111	600784	243	601234	103	601578	516	602217	24
600154	49	600488	119	600785	244	601235	105	601579	522	602233	520
600156	590	600492	112	600786	244	601240	107	601581	523	602234	520
600157	19	600493	120	600787	242	601241	110	601582	523	602235	520
600174	44	600496	112	600795	69	601242	118	601583	522	602236	520
600191	48	600506	120	600796	40	601243	110	601584	522	602242	63
600192	49	600512	230	600806	230	601306	42	601585	523	602245	31
600210	40	600514	116	600840	241	601401	390	601586	523	602264	21
600211	39	600515	115	600841	241	601402	390	601587	496	602265	183
600261	30	600516	115	600845	34	601403	390	601588	498	602266	53
600288	61	600534	115	600855	375	601404	390	601589	496	602269	53
600311	341	600535	121	600878	284	601405	54	601590	500	602316	31
600321	48	600542	377	600955	375	601406	415	601591	509	602317	31
600323	231	600544	377	600962	548	601529	492	601592	508	602320	25
600340	286	600545	377	600963	548	601531	493	601592	508	602321	25
600341	287	600548	116	600964	548	601532	491	601650	474	602325	26
600343	227	600549	117	600965	549	601533	491	601750	218	602325	26
600350	102	600552	122	600966	549	601533	491	601751	212	602334	26
600353	227	600562	113	600967	550	601534	492	601752	213	602335	215
600354	104	600572	113	600968	552	601535	492	601753	213	602350	28
600360	226	600573	229	600969	552	601536	495	601754	51	602351	28
600365	323	600574	229	600970	554	601537	495	601755	213	602352	33
600367	22	600580	228	600971	553	601538	496	601857	52	602353	33
600368	60	600585	228	600972	553	601539	496	602012	456	602354	29
600369	22	600596	287	600973	553	601540	497	602013	456	602355	29
600370	60	600615	200	600974	554	601541	498	602014	457	602356	33
600371	104	600616	200	600975	554	601542	497	602015	457	602357	33
600374	106	600617	200	600976	555	601543	498	602019	476	602365	474
600375	342	600618	201	600977	556	601544	493	602021	59	602395	37
600376	106	600621	50	600978	557	601545	494	602024	458	602396	37
600380	104	600627	201	600979	557	601546	494	602034	458	602540	424
600383	227	600635	234	600980	557	601549	500	602045	458	602682	371
600384	106	600636	234	600980	557	601550	501	602050	169	603030	476
600385	20	600637	285	601002	54	601551	501	602057	320	603034	476
600386	102	600638	50	601003	54	601552	504	602058	459	603825	329
600388	107	600639	50	601030	389	601553	504	602059	459	603826	330
600389	107	600659	285	601040	389	601554	508	602060	474	603828	41
600396	288	600663	284	601041	389	601555	508	602082	57	604040	323
600398	108	600667	434	601086	114	601556	509	602102	26	604111	546
600404	46	600668	434	601087	121	601558	510	602103	31	604112	546
600405	335	600670	240	601088	123	601559	510	602104	26	604113	547
600407	118	600671	240	601089	114	601560	507	602111	61	604114	547
600408	108	600672	240	601092	114	601561	506	602117	21	604115	506
600414	108	600676	434	601095	123	601562	511	602170	43	604116	507
600422	109	600687	286	601097	117	601563	513	602174	43	604117	505
600428	108	600688	288	601098	122	601564	512	602175	170	604118	499
600436	109	600697	281	601099	123	601566	512	602177	71	604119	503
				601100	389	601567	512	602183	192	604120	505

Order No.	Page	Order No.	Page	Order No.	Page	Order No.	Page	Order No.	Page	Order No.	Page	Order No.	Page	Order No.	Page	Order No.	Page	Order No.	Page	Order No.	Page		
606153	282	613087	46	0104003000	438	600676000	434	615025000	337	616215000	139	616462000	140	616751000	137	623176000	145	623339000	297	623479000	187	623567000	187
606154	283	613101	68	0104004000	438	600724000	370	615050000	337	616216000	136	616464000	140	616752000	137	623177000	145	623340000	297	623480000	187	623569000	79
606156	282	613102	47	0104605000	438	600737000	365	616100000	135	616217000	136	616465000	140	616753000	137	623178000	145	623341000	297	623481000	187	623591000	401
606157	283	614044	317	0104705000	438	600738000	365	616101000	135	616218000	136	616468000	140	616754000	141	623195000	145	623342000	297	623482000	187	623595000	401
606162	481	614045	317	0114026000	451	600890000	273	616102000	135	616219000	136	616477000	134	616760000	141	623196000	145	623344000	297	623483000	187	623596000	401
606163	481	614046	317	0114026100	451	601229000	366	616103000	135	616220000	136	616479000	138	616763000	141	623197000	145	623345000	297	623484000	187	623597000	401
606164	483	614047	317	0130170100	468	601579000	522	616104000	135	616222000	136	616486000	140	616770000	134	623198000	145	623347000	297	623485000	187	623599000	591
606165	483	615025	337	0130200100	469	601579010	522	616105000	135	616224000	136	616487000	140	616792000	141	623259000	273	623349000	297	623486000	187	623600000	399
606166	484	615050	337	0130200110	469	601579180	522	616107000	135	616226000	136	616500000	137	616795000	141	623262000	89	623350000	297	623487000	187	623603000	394
606167	484	615250	170	0192901000	430	601580000	522	616109000	135	616227000	136	616501000	137	616796000	141	623265000	172	623351000	302	623488000	187	623604000	397
606176	64	618121	478	0192901018	430	601580010	522	616111000	135	616228000	136	616505000	134	619000650	55	623272000	171	623352000	302	623494000	187	623605000	394
606177	405	619000	422	0193330000	431	601580180	522	616115000	135	616229000	136	616506000	134	619001650	55	623273000	171	623353000	302	623495000	186	623606000	394
606178	405	619001	422	0193330018	431	601581000	523	616119000	135	616270000	135	616507000	134	619003000	424	623275000	151	623354000	302	623496000	186	623607000	394
606212	22	619002	51	0200033000	450	601581010	523	616121000	134	616271000	135	616508000	134	619004000	428	623276000	166	623355000	302	623499000	188	623608000	395
606213	22	619003	424	0250400055	558	601581180	523	616122000	137	616273000	135	616509000	134	619008000	444	623278000	151	623356000	302	623501000	189	623609000	395
606461	125	619004	428	0250500050	558	601582000	523	616123000	134	616274000	135	616512000	137	619009000	445	623279000	151	623357000	302	623503000	189	623617000	396
606462	127	619125	217	0250660000	540	601582010	523	616126000	137	616275000	140	616513000	137	619010000	445	623280000	151	623358000	302	623505000	189	623618000	397
606463	125	619150	217	0250660006	541	601582180	523	616127000	134	616276000	140	616514000	137	619125000	217	623281000	151	623359000	302	623506000	189	623620000	398
606464	127	619175	218	0250750000	545	601583000	522	616135000	138	616277000	140	616515000	137	619150000	217	623282000	151	623365000	302	623507000	188	623621000	396
606465	127	619200	219	0250750013	542	601583180	522	616136000	138	616279000	140	616516000	137	619175000	218	623283000	151	623366000	302	623508000	188	623622000	398
606466	125	619201	219	0250750100	543	601584000	522	616137000	138	616285000	137	616517000	142	619200000	219	623284000	151	623367000	302	623509000	188	623623000	397
606467	128	619216	423	0250800000	540	601584180	522	616143000	138	616286000	137	616518000	142	619201000	219	623287000	171	623368000	302	623510000	188	623624000	394
606468	125	619250	219	0250800002	541	601585000	523	616147000	138	616290000	141	616519000	142	619216000	423	623288000	171	623369000	302	623511000	189	623629000	397
606469	128	619260	423	0251200009	542	601585010	523	616155000	138	616291000	141	616554000	140	619250000	219	623289000	171	623370000	303	623512000	186	623631000	394
606470	128	619261	423	0251300000	540	601585180	523	616156000	138	616299000	135	616560000	140	619260000	423	623290000	151	623371000	306	623513000	187	623632000	394
606471	126	619305	424	0251400000	544	601586000	523	616163000	135	616300000	134	616561000	140	619261000	423	623291000	151	623375000	303	623514000	187	623633000	394
606472	128	620001	309	0251500000	545	601586010	523	616167000	135	616302000	134	616563000	140	622971000	150	623292000	151	623376000	303	623519000	186	623634000	395
606473	126	620002	309	0251600000	544	601586180	523	616170000	142	616303000	138	616572000	140	622972000	150	623298000	179	623377000	303	623520000	188	623635000	395
606474	129	620016	572	0251800000	545	601750000	218	616171000	142	616310000	134	616573000	140	622973000	150	623299000	303	623378000	303	623521000	265	623636000	396
606475	129	620017	572	600065500	341	601751700	212	616177000	142	616312000	138	616604000	141	622974000	150	623300000	148	623379000	303	623522000	188	623637000	396
606476	129	620018	572	600066500	339	601752500	213	616179000	136	616313000	134	616610000	141	622975000	150	623309000	588	623380000	303	623524000	188	623638000	397
608745	573	620044	308	600103000	361	601753500	213	616180000	136	616327000	139	616622000	141	622976000	150	623310000	297	623381000	303	623525000	188	623639000	398
608755	573	620045	308	600129000	336	601755500	213	616181000	136	616328000	139	616654000	141	622977000	150	623311000	297	623382000	303	623526000	187	623640000	398
608765	573	620046	308	600131000	336	602082700	371	616182000	136	616338000	139	616660000	141	622981000	150	623312000	297	623383000	302	623527000	187	623641000	398
608855	574	620047	35	600136000	361	602117600	21	616183000	136	616339000	139	616672000	141	622982000	150	623313000	297	623384000	302	623528000	187	623645000	399
608865	574	620048	35	600211660	39	602117610	21	616184000	136	616343000	139	616680000	140	622984000	150	623314000	297	623385000	302	623529000	190	623646000	394
608875	574	620049	35	600211930	39	602244000	180	616185000	136	616358000	590	616725000	140	622985000	150	623315000	297	623386000	302	623530000	190	623647000	396
609225	335	657025	64	600311500	341	602244500	180	616186000	136	616359000	590	616726000	140	622986000	150	623316000	297	623387000	302	623531000	271	623648000	398
611216	426	657026	64	600321850	180	602259000	185	616187000	136	616364000	590	616727000	134	622987000	150	623317000	297	623391000	304	623536000	190	623649000	394
611350	340	657027	64	600375000	342	602259500	185	616188000	135	616420000	134	616728000	138	622991000	150	623318000	297	623392000	304	623537000	190	623650000	395
611351	340	657028	64	600405000	335	602351770	28	616189000	135	616428000	138	616729000	141	622992000	150	623319000	297	623393000	304	623538000	190	623651000	394
611750	218	657029	64	600408500	321	602540000	424	616191000	135	616429000	140	616730000	140	622994000	150	623320000	297	623394000	304	623539000	190	623652000	398
612216	426	657030	64	600408510	321	602682000	371	616192000	135	616442000	134	616731000	141	622995000	150	623321000	297	623395000	304	623541000	190	623654000	395
613021	57	657031	64	600441500	340	605052000	446	616195000	138	616444000	134	616732000	134	622996000	150	623322000	297	623396000	304	623542000	186	623657000	399
613022	52	0102540200	427	600442500	340	605053000	446	616196000	138	616446000	134	616733000	138	622997000	150	623323000	297	623398000	304	623545000	385	623658000	399
613024	433	0102540300	427	600443500	336	609225500	335	616197000	87	616447000	134	616735000	141	623031000	303	623324000	297	623399000	304	623546000	385	623	

Order No.	Page	Order No.	Page	Order No.	Page	Order No.	Page	Order No.	Page	Order No.	Page	Order No.	Page	Order No.	Page	Order No.	Page	Order No.	Page	Order No.	Page	Order No.	Page
623684000	398	623923000	395	624028000	348	624139000	149	624481000	351	624968000	171	625168000	269	625235000	293	625605000	354	625790000	351	626171000	146	626228000	294
623685000	395	623924000	396	624029000	348	624140000	149	624482000	351	624970000	355	625169000	269	625236000	293	625606000	354	625791000	351	626172000	291	626229000	294
623686000	396	623925000	397	624030000	348	624141000	149	624483000	351	624971000	355	625170000	269	625237000	293	625607000	354	625792000	351	626173000	291	626230000	294
623687000	398	623929000	397	624031000	348	624142000	149	624484000	351	624972000	355	625171000	269	625238000	293	625608000	354	625793000	351	626174000	291	626231000	295
623688000	398	623933000	395	624032000	348	624143000	149	624485000	351	624980000	355	625172000	269	625239000	293	625609000	354	625795000	353	626175000	291	626232000	295
623690000	394	623934000	168	624033000	348	624144000	149	624486000	351	624981000	355	625173000	269	625240000	293	625610000	354	625881000	352	626176000	291	626233000	295
623691000	395	623935000	168	624034000	348	624145000	149	624490000	353	624982000	356	625174000	269	625241000	293	625611000	354	625882000	352	626177000	291	626234000	295
623692000	396	623936000	400	624035000	348	624216000	149	624491000	351	624983000	356	625175000	269	625242000	293	625612000	354	625883000	352	626178000	291	626235000	295
623693000	396	623937000	400	624036000	348	624217000	149	624492000	351	624984000	356	625176000	269	625243000	293	625613000	354	625884000	352	626179000	291	626236000	295
623694000	395	623938000	400	624037000	345	624218000	149	624493000	351	624985000	356	625177000	269	625244000	293	625614000	354	625885000	352	626180000	291	626237000	294
623695000	395	623939000	401	624041000	346	624219000	149	624494000	351	624986000	356	625178000	269	625245000	293	625615000	354	625886000	352	626181000	291	626238000	295
623696000	396	623940000	400	624042000	346	624220000	149	624495000	351	624987000	356	625179000	269	625246000	293	625616000	354	625887000	352	626182000	291	626239000	295
623697000	397	623941000	400	624043000	346	624221000	149	624496000	351	624988000	356	625180000	269	625247000	293	625617000	354	625888000	352	626183000	291	626240000	294
623698000	399	623942000	400	624044000	346	624222000	149	624497000	351	624992000	355	625181000	269	625248000	293	625618000	354	625891000	352	626184000	291	626241000	294
623703000	395	623943000	400	624045000	346	624223000	149	624721000	353	624994000	356	625182000	269	625249000	292	625619000	351	625892000	352	626185000	291	626243000	291
623704000	395	623944000	400	624046000	346	624224000	149	624722000	353	624995000	356	625184000	270	625250000	292	625620000	351	625893000	352	626186000	291	626244000	291
623710000	151	623945000	399	624047000	346	624225000	149	624723000	353	624996000	356	625185000	270	625251000	292	625621000	351	625894000	352	626187000	291	626245000	295
623711000	151	623948000	396	624048000	346	624226000	149	624724000	353	625006000	255	625186000	270	625254000	292	625622000	351	625895000	352	626188000	291	626246000	295
623712000	394	623949000	396	624051000	346	624227000	150	624725000	353	625007000	255	625187000	270	625255000	292	625623000	351	625896000	352	626189000	291	626248000	295
623715000	152	623950000	397	624052000	346	624228000	150	624726000	353	625009000	255	625188000	270	625256000	291	625624000	351	625897000	352	626190000	291	626249000	295
623719000	152	623960000	394	624053000	346	624239000	145	624727000	353	625011000	255	625189000	270	625257000	291	625625000	351	625898000	352	626191000	291	626268000	295
623729000	79	623961000	395	624054000	346	624241000	145	624728000	353	625013000	255	625190000	270	625258000	291	625641000	352	625928000	359	626192000	291	626269000	295
623740000	172	623962000	395	624055000	346	624243000	145	624729000	353	625015000	255	625191000	270	625259000	292	625643000	352	625929000	359	626193000	291	626270000	295
623741000	172	623964000	394	624056000	346	624244000	145	624736000	353	625017000	255	625192000	270	625344000	72	625644000	352	625930000	359	626194000	291	626271000	295
623742000	172	623965000	396	624057000	346	624246000	146	624737000	353	625019000	255	625193000	270	625354000	310	625645000	352	625931000	359	626195000	291	626272000	295
623751000	580	623968000	399	624058000	346	624247000	146	624738000	353	625020000	265	625194000	270	625367000	72	625646000	352	625932000	359	626196000	291	626273000	295
623752000	580	623969000	395	624059000	346	624248000	146	624739000	344	625021000	265	625195000	270	625368000	72	625657000	353	625933000	359	626197000	291	626274000	295
623757000	580	623970000	397	624060000	349	624256000	145	624740000	345	625022000	265	625196000	270	625369000	72	625658000	344	625940000	359	626198000	291	626275000	295
623758000	580	623971000	397	624061000	345	624258000	145	624749000	353	625023000	265	625197000	270	625390000	310	625681000	356	625941000	359	626199000	291	626276000	295
623759000	580	623972000	397	624063000	172	624259000	145	624826000	352	625024000	265	625198000	270	625391000	310	625682000	356	625942000	359	626200000	294	626277000	295
623760000	580	623973000	397	624064000	344	624275000	145	624827000	352	625025000	265	625199000	270	625434000	271	625683000	356	625943000	359	626201000	294	626278000	295
623767000	78	623974000	398	624066000	349	624276000	146	624828000	352	625031000	257	625200000	270	625435000	271	625684000	356	625944000	359	626202000	294	626279000	194
623768000	78	623975000	396	624081000	348	624277000	145	624829000	352	625033000	257	625201000	270	625437000	73	625685000	356	626117000	294	626203000	294	626280000	194
623796000	151	623976000	395	624082000	348	624278000	145	624830000	352	625038000	257	625202000	270	625438000	72	625686000	356	626118000	294	626204000	294	626281000	194
623796700	151	623977000	396	624083000	348	624279000	145	624831000	352	625043000	257	625203000	270	625451000	578	625687000	356	626119000	295	626205000	294	626282000	194
623801000	152	623978000	397	624084000	348	624306000	590	624832000	352	625050000	257	625204000	270	625453000	72	625688000	356	626120000	295	626206000	294	626283000	194
623803000	152	623979000	397	624085000	348	624307000	590	624840000	171	625053000	257	625205000	270	625487000	72	625726000	348	626121000	295	626207000	294	626284000	194
623804000	151	623980000	395	624086000	348	624308000	590	624873000	149	625055000	257	625206000	270	625491000	409	625727000	348	626122000	295	626208000	294	626285000	194
623805000	152	623988000	395	624087000	348	624309000	590	624912000	171	625057000	257	625207000	270	625492000	409	625728000	348	626123000	295	626209000	294	626286000	194
623851000	578	623999000	396	624088000	348	624310000	590	624913000	171	625059000	257	625208000	270	625494000	411	625729000	348	626124000	294	626210000	294	626290000	195
623852000	578	624001000	347	624089000	348	624346000	149	624915000	171	625062000	257	625209000	270	625497000	411	625730000	348	626150000	150	626211000	294	626291000	195
623854000	577	624002000	347	624092000	171	624347000	149	624916000	171	625064000	257	625210000	270	625529000	72	625731000	348	626151000	150	626212000	294	626292000	195
623855000	577	624003000	347	624094000	149	624356000	146	624926000	171	625066000	257	625211000	270	625580000	587	625732000	348	626152000	150	626213000	294	626293000	195
623856000	577	624004000	347	624101000	150	624358000	146	624927000	171	625123000	267	625213000	270	625585000	72	625733000	348	626153000	150	626214000	294	626294000	195
623857000	577	624005000	347	624102000	150	624359000	146	624940000	355	625126000	267	625214000	270	625590000	72	625734000	348	626154000	150	626215000	294	6	

Order No.	Page	Order No.	Page	Order No.	Page	Order No.	Page	Order No.	Page	Order No.	Page	Order No.	Page	Order No.	Page	Order No.	Page	Order No.	Page	Order No.	Page		
626308000	194	626401000	184	626510000	235	626596000	236	626683000	349	626851000	346	627010000	268	627154000	589	627317000	267	627437000	258	627534000	263	627680000	263
626309000	194	626402000	184	626511000	235	626597000	236	626684000	349	626852000	346	627012000	268	627156000	589	627318000	268	627438000	258	627535000	263	627681000	263
626310000	194	626403000	148	626512000	235	626598000	236	626685000	349	626853000	347	627013000	268	627157000	589	627319000	268	627439000	258	627536000	263	627682000	263
626311000	195	626404000	148	626513000	235	626599000	236	626686000	349	626854000	347	627037000	269	627158000	254	627320000	268	627440000	258	627537000	263	627683000	263
626312000	195	626405000	186	626514000	235	626600000	237	626687000	349	626855000	347	627038000	269	627159000	255	627321000	268	627441000	258	627538000	263	627684000	263
626313000	195	626406000	186	626515000	235	626602000	237	626688000	349	626856000	347	627039000	269	627160000	254	627322000	268	627442000	258	627539000	263	627687000	263
626314000	195	626407000	186	626516000	235	626603000	237	626689000	349	626857000	348	627040000	269	627161000	254	627323000	268	627443000	258	627544000	263	627688000	263
626315000	195	626408000	186	626517000	235	626604000	237	626690000	349	626858000	348	627041000	304	627162000	254	627324000	268	627444000	258	627579000	267	627689000	263
626316000	195	626409000	186	626518000	235	626605000	237	626691000	349	626859000	348	627042000	304	627164000	254	627325000	268	627445000	258	627580000	267	627691000	263
626319000	195	626410000	186	626519000	235	626606000	237	626699000	310	626860000	348	627043000	304	627171000	259	627326000	268	627446000	258	627581000	267	627692000	263
626320000	195	626411000	167	626520000	235	626608000	237	626700000	582	626861000	348	627044000	73	627173000	259	627327000	268	627447000	258	627582000	267	627693000	263
626322000	195	626413000	190	626521000	235	626609000	237	626701000	581	626862000	348	627053000	74	627174000	255	627328000	268	627448000	258	627583000	267	627694000	263
626323000	195	626414000	190	626522000	235	626610000	237	626702000	583	626863000	348	627064000	74	627176000	259	627329000	268	627449000	258	627584000	267	627695000	263
626344000	181	626415000	147	626523000	235	626611000	237	626703000	581	626864000	348	627077000	77	627179000	268	627330000	259	627450000	258	627585000	267	627696000	263
626345000	181	626416000	147	626524000	235	626614000	236	626704000	583	626865000	348	627094000	257	627180000	262	627331000	259	627451000	258	627586000	267	627697000	261
626346000	181	626417000	147	626525000	235	626616000	236	626705000	586	626902000	299	627096000	257	627181000	262	627332000	259	627452000	258	627587000	267	627698000	261
626347000	181	626418000	151	626526000	235	626618000	236	626706000	586	626903000	299	627097000	257	627182000	262	627333000	259	627454000	258	627588000	267	627699000	261
626348000	181	626419000	417	626527000	235	626620000	236	626707000	585	626904000	299	627098000	257	627185000	263	627334000	259	627455000	258	627589000	267	627700000	253
626349000	181	626420000	417	626528000	235	626622000	236	626708000	586	626905000	299	627100000	273	627190000	268	627335000	259	627456000	258	627590000	267	627701000	253
626350000	181	626421000	418	626529000	235	626623000	236	626709000	583	626911000	299	627107000	210	627191000	259	627336000	259	627457000	258	627591000	267	627702000	253
626351000	181	626427000	448	626530000	235	626624000	236	626710000	582	626912000	299	627111000	266	627192000	261	627337000	259	627458000	258	627592000	267	627703000	253
626352000	181	626428000	448	626531000	235	626640000	363	626711000	584	626913000	299	627112000	257	627193000	261	627338000	259	627459000	258	627593000	267	627704000	253
626353000	181	626429000	448	626532000	235	626641000	363	626712000	584	626914000	299	627115000	266	627200000	265	627339000	265	627460000	258	627594000	267	627705000	253
626354000	181	626431000	576	626533000	235	626642000	363	626713000	584	626915000	299	627116000	266	627202000	265	627340000	265	627461000	258	627595000	267	627706000	253
626355000	181	626432000	576	626534000	235	626643000	363	626721000	582	626916000	299	627119000	258	627224000	262	627347000	267	627462000	258	627596000	267	627707000	253
626360000	181	626433000	576	626535000	235	626644000	363	626723000	584	626917000	299	627120000	258	627225000	262	627354000	210	627463000	258	627597000	267	627708000	253
626361000	181	626436000	576	626536000	235	626645000	363	626724000	590	626918000	299	627121000	258	627226000	262	627355000	78	627464000	258	627598000	267	627709000	253
626362000	181	626438000	576	626537000	235	626646000	363	626725000	585	626919000	299	627122000	258	627227000	262	627360000	166	627465000	258	627599000	267	627710000	253
626363000	181	626442000	576	626538000	235	626647000	363	626726000	585	626920000	299	627124000	266	627228000	262	627361000	166	627466000	258	627601000	272	627711000	253
626368000	147	626446000	576	626539000	235	626648000	363	626728000	587	626921000	299	627125000	266	627229000	262	627362000	89	627467000	261	627608000	272	627712000	253
626369000	147	626449000	576	626540000	235	626649000	363	626729000	587	626922000	299	627126000	266	627230000	262	627389000	262	627468000	261	627609000	209	627713000	253
626370000	147	626460000	87	626541000	235	626650000	363	626730000	165	626923000	299	627127000	266	627235000	76	627391000	262	627469000	261	627621000	272	627714000	253
626371000	148	626461000	87	626571000	236	626651000	363	626731000	165	626924000	299	627128000	266	627237000	76	627392000	262	627470000	261	627625000	261	627715000	253
626372000	148	626462000	87	626572000	236	626652000	363	626732000	166	626950000	416	627129000	266	627238000	76	627393000	262	627471000	261	627626000	261	627716000	253
626373000	148	626463000	87	626573000	236	626653000	363	626733000	166	626951000	416	627130000	266	627240000	76	627394000	262	627473000	261	627627000	261	627717000	253
626374000	148	626464000	87	626574000	236	626654000	363	626734000	318	626952000	416	627131000	266	627241000	76	627395000	262	627474000	261	627640000	272	627718000	253
626375000	148	626470000	88	626575000	236	626655000	363	626735000	318	626953000	416	627132000	266	627242000	76	627396000	262	627476000	261	627641000	448	627719000	253
626376000	179	626471000	88	626576000	236	626656000	363	626736000	318	626954000	416	627133000	266	627243000	263	627399000	262	627478000	261	627642000	448	627720000	253
626377000	179	626482000	88	626577000	236	626657000	364	626737000	318	626955000	416	627134000	266	627244000	263	627401000	259	627480000	261	627643000	448	627721000	253
626378000	182	626483000	88	626578000	236	626658000	364	626738000	318	626956000	416	627135000	266	627245000	263	627402000	259	627487000	261	627644000	448	627722000	253
626379000	182	626486000	88	626579000	236	626659000	363	626739000	318	626957000	416	627136000	266	627246000	263	627403000	259	627490000	261	627646000	261	627723000	253
626380000	182	626487000	88	626580000	236	626660000	363	626741000	318	626958000	416	627137000	266	627247000	263	627404000	259	627491000	261	627650000	261	627724000	253
626381000	182	626488000	87	626581000	236	626661000	364	626742000	318	626959000	417	627138000	266	627256000	76	627405000	259	627492000	261	627651000	261	627725000	253
626382000	182	626489000	87	626582000	236	626662000	364	626743000	318	626960000	416	627139000	266	627259000	76	627409000	262	627493000	261	627652000	261	627726000	253
626383000	181	626490000	87	626583000	236	626663000	364	626744000	318	626961000	417	627140000	266	627261000	77	627410000	262	627514000	257	627653000	261	627727000	253
62																							

Order No.	Page	Order No.	Page	Order No.	Page	Order No.	Page	Order No.	Page	Order No.	Page	Order No.	Page	Order No.	Page	Order No.	Page	Order No.	Page	Order No.	Page		
627740000	253	627820000	254	627977000	256	628041000	382	628116000	155	628190000	157	628268000	409	628359000	204	628704000	532	628820000	530	629093000	220	630282000	372
627741000	253	627852000	255	627978000	256	628042000	383	628117000	155	628192000	157	628269000	411	628360000	204	628705000	532	628821000	560	629094000	220	630296000	466
627742000	253	627857000	255	627980000	256	628043000	383	628118000	155	628193000	157	628270000	332	628361000	204	628706000	532	628822000	524	629095000	220	630298000	466
627743000	253	627862000	255	627981000	256	628044000	382	628121000	155	628194000	157	628271000	332	628362000	204	628707000	532	628823000	524	629096000	220	630299000	467
627744000	253	627867000	255	627982000	256	628045000	383	628123000	155	628195000	157	628272000	383	628363000	204	628708000	532	628824000	530	629097000	221	630311000	467
627745000	253	627872000	255	627983000	256	628046000	383	628124000	156	628196000	157	628298000	325	628364000	204	628720000	533	628831000	315	629098000	221	630312000	463
627746000	253	627874000	255	627984000	256	628048000	383	628125000	156	628201000	304	628299000	325	628365000	205	628721000	533	628832000	315	629099000	221	630314000	463
627747000	253	627875000	255	627985000	256	628049000	383	628126000	156	628202000	304	628300000	159	628366000	205	628722000	533	628833000	315	629102000	220	630316000	463
627748000	253	627877000	255	627986000	265	628051000	383	628127000	156	628203000	305	628301000	159	628367000	205	628730000	533	628834000	315	629103000	220	630317000	463
627749000	253	627882000	255	627987000	265	628053000	383	628128000	156	628204000	305	628302000	159	628368000	205	628731000	533	628835000	315	629104000	220	630320000	464
627750000	253	627883000	255	627988000	265	628054000	383	628129000	156	628205000	158	628303000	159	628369000	205	628732000	533	628836000	310	629105000	220	630321000	464
627751000	253	627884000	255	627989000	265	628055000	383	628130000	156	628206000	158	628304000	159	628370000	205	628733000	533	628838000	310	629106000	220	630322000	464
627752000	253	627887000	255	627990000	265	628056000	383	628131000	156	628208000	158	628305000	159	628371000	205	628734000	533	628843000	311	629174800	143	630323000	464
627753000	253	627890000	255	627991000	265	628057000	383	628132000	156	628209000	158	628306000	159	628372000	204	628735000	533	628845000	311	629175300	143	630324000	464
627754000	254	627892000	255	627992000	265	628058000	383	628133000	156	628214000	331	628307000	159	628373000	204	628736000	532	628847000	311	629178000	301	630325000	466
627755000	254	627893000	255	627993000	265	628059000	383	628134000	156	628215000	332	628308000	159	628374000	204	628737000	533	628848000	502	629179000	301	630326000	467
627756000	254	627894000	255	627994000	265	628060000	383	628135000	156	628218000	332	628309000	159	628375000	205	628738000	532	628849000	310	629180000	302	630327000	167
627757000	254	627897000	256	627995000	265	628061000	383	628136000	156	628219000	332	628310000	159	628376000	205	628739000	533	628850000	310	629181000	302	630328000	464
627758000	254	627902000	256	627996000	265	628062000	383	628139000	156	628220000	381	628311000	159	628377000	205	628740000	534	628860000	514	630001000	475	630329000	464
627759000	254	627907000	256	627997000	265	628063000	384	628141000	157	628221000	383	628312000	159	628378000	205	628741000	534	628861000	514	630002000	475	630343000	466
627760000	254	627910000	256	627998000	265	628064000	383	628142000	157	628222000	383	628313000	159	628379000	208	628746000	534	628862000	514	630003000	475	630344000	325
627761000	254	627912000	256	627999000	265	628065000	383	628143000	157	628223000	384	628314000	159	628380000	208	628747000	534	628863000	514	630004000	475	630346000	164
627762000	254	627917000	256	628000000	384	628066000	385	628144000	157	628224000	383	628315000	159	628381000	208	628748000	534	628870000	514	630005000	475	630351000	164
627763000	254	627922000	256	628001000	381	628070000	384	628145000	157	628225000	383	628316000	159	628382000	208	628749000	534	628871000	514	630006000	475	630352000	164
627764000	254	627924000	256	628002000	381	628071000	384	628146000	157	628226000	384	628317000	159	628383000	208	628754000	534	628872000	514	630007000	475	630353000	164
627765000	254	627927000	256	628004000	381	628072000	384	628149000	157	628227000	383	628318000	159	628384000	208	628755000	534	628873000	514	630022000	475	630355000	88
627766000	254	627932000	256	628005000	381	628073000	384	628151000	157	628228000	383	628322000	159	628385000	208	628756000	534	628874000	514	630105000	367	630356000	164
627767000	254	627937000	256	628006000	381	628074000	384	628152000	157	628229000	383	628329000	210	628386000	208	628759000	531	629004000	442	630106000	367	630357000	164
627768000	254	627942000	256	628007000	381	628075000	384	628153000	157	628230000	381	628330000	207	628387000	208	628760000	531	629005000	442	630118000	367	630359000	466
627769000	254	627943000	256	628008000	381	628076000	384	628154000	157	628231000	295	628331000	207	628388000	208	628768000	529	629006000	442	630119000	367	630360000	367
627770000	254	627944000	256	628009000	381	628077000	384	628155000	157	628240000	413	628332000	207	628389000	208	628769000	529	629008000	443	630120000	367	630362000	164
627771000	254	627945000	256	628010000	381	628078000	384	628156000	155	628241000	413	628333000	207	628390000	208	628779000	529	629009000	443	630121000	367	630363000	164
627772000	254	627946000	256	628011000	381	628079000	384	628157000	155	628242000	413	628334000	207	628391000	208	628781000	529	629010000	386	630142000	310	630364000	164
627773000	254	627947000	256	628012000	381	628081000	384	628158000	155	628243000	413	628335000	207	628392000	208	628783000	529	629011000	386	630148000	78	630370000	164
627774000	254	627948000	256	628013000	381	628082000	384	628159000	155	628244000	413	628336000	207	628393000	208	628790000	485	629011700	386	630171000	463	630371000	164
627775000	254	627949000	256	628014000	381	628083000	384	628160000	155	628245000	413	628337000	207	628394000	208	628791000	79	629013000	386	630172000	467	630372000	89
627776000	254	627950000	256	628015000	381	628084000	384	628161000	155	628246000	411	628338000	207	628395000	208	628792000	485	629014000	386	630173000	466	630373000	164
627777000	254	627951000	256	628016000	381	628085000	384	628164000	155	628247000	411	628339000	207	628396000	208	628799000	566	629020000	387	630174000	577	630378000	89
627778000	254	627952000	256	628017000	381	628087000	384	628166000	155	628248000	411	628340000	207	628397000	208	628800000	560	629021000	387	630175000	467	630383000	164
627779000	254	627953000	256	628018000	381	628088000	384	628167000	155	628249000	411	628341000	204	628398000	208	628801000	560	629023000	387	630187000	208	630386000	164
627780000	254	627954000	256	628019000	381	628090000	384	628168000	155	628250000	412	628342000	204	628399000	208	628802000	559	629024000	387	630189000	209	630387000	164
627781000	254	627955000	256	628020000	381	628091000	384	628169000	155	628251000	409	628343000	204	628400000	208	628803000	563	629025000	387	630191000	209	630388000	164
627782000	254	627957000	256	628021000	381	628092000	384	628170000	155	628252000	409	628344000	204	628401000	205	628804000	565	629060000	221	630192000	209	630390000	164
627783000	254	627958000	256	628023000	381	628093000	384	628171000	155	628253000	409	628345000	204	628402000	204	628805000	563	629061000	221	630194000	209	630419000	581
627784000	254	627960000	256	628024000	381	628094000	382	628172000	156	628254000	409	628346000	204	628403000	206	628806000	517	629062000	221	630195000	209	63044	



Order No.	Page	Order No.	Page	Order No.	Page	Order No.	Page	Order No.	Page	Order No.	Page	Order No.	Page	Order No.	Page	Order No.	Page	Order No.	Page	Order No.	Page		
630519000	292	630727000	143	630992000	301	631219000	344	631492000	411	631805000	292	631894000	467	635049000	248	636517000	248	685111000	75	0901026025	533	0901053855	514
630526000	292	630728000	143	631001000	359	631220000	344	631493000	409	631806000	293	631907000	414	635050000	248	636518000	247	685115000	75	0901026041	535	0901053863	514
630527000	292	630777000	220	631002000	359	631222000	273	631494000	409	631807000	293	631909000	410	635054000	248	636519000	247	685117000	75	0901026050	535	0901053871	514
630528000	292	630778000	220	631003000	359	631223000	172	631495000	411	631808000	293	631910000	413	635056000	248	636520000	247	685120000	66	0901026068	535	0901053880	514
630531000	292	630779000	220	631004000	359	631224000	344	631501000	368	631809000	293	631911000	411	635058000	248	636601000	246	685121000	66	0901026076	535	0901053898	514
630532000	292	630784000	220	631005000	359	631226000	346	631503000	367	631810000	293	631912000	412	635072000	248	636602000	246	685122000	75	0901026084	535	0901053901	514
630533000	293	630785000	220	631006000	359	631227000	346	631504000	367	631811000	293	631913000	413	635100000	77	636608000	76	685123000	66	0901026092	535	0901054568	530
630536000	293	630788000	220	631007000	359	631228000	346	631505000	367	631812000	293	631914000	411	635104000	249	636609000	248	685124000	66	0901026106	535	0901054584	526
630537000	293	630789000	220	631008000	359	631229000	346	631507000	367	631814000	293	631915000	412	635105000	249	636612000	247	685125000	66	0901026130	534	0901054908	529
630538000	293	630792000	89	631019000	387	631230000	346	631567000	367	631815000	293	631916000	414	635114000	249	636613000	247	685126000	66	0901026149	534	0901054916	529
630539000	293	630796000	325	631020000	387	631231000	346	631582000	311	631816000	293	631917000	414	635115000	249	636614000	247	685128000	66	0901026157	534	0901054924	529
630540000	293	630798000	463	631031000	387	631232000	349	631583000	349	631817000	414	631918000	414	635116000	249	636615000	246	685129000	66	0901026173	534	0901054932	529
630541000	293	630800000	167	631034000	359	631233000	350	631584000	346	631818000	414	631920000	305	635125000	249	636616000	246	685130000	75	0901026190	534	0901054940	529
630542000	293	630802000	167	631039000	591	631235000	357	631585000	346	631819000	414	631921000	305	635126000	249	636617000	246	685131000	75	0901026203	534	0901054959	529
630545000	452	630813000	164	631040000	591	631236000	346	631586000	346	631820000	291	631922000	305	635128000	249	636619000	246	685132000	75	0901026220	535	0901054967	529
630548000	293	630814000	164	631041000	214	631248000	368	631587000	346	631821000	291	631923000	305	635132000	249	636620000	246	685133000	75	0901026238	535	0901054975	530
630549000	293	630820000	209	631042000	214	631249000	402	631588000	346	631822000	292	631924000	305	635133000	249	636621000	246	685134000	75	0901026246	535	0901054983	536
630550000	274	630824000	588	631052000	274	631285000	306	631589000	346	631823000	292	631925000	412	635143000	249	636623000	77	685135000	75	0901026254	535	0901054991	536
630551000	274	630829000	274	631053000	477	631286000	357	631595000	295	631824000	292	631926000	412	635144000	249	636624000	246	685136000	75	0901026262	521	0901055769	521
630552000	274	630832000	167	631074000	274	631287000	357	631596000	346	631825000	292	631927000	306	635146000	249	636625000	246	685137000	66	0901026289	535	0901056048	529
630554000	274	630833000	209	631078000	271	631288000	357	631597000	346	631826000	292	631928000	305	635165000	249	642395000	249	685138000	66	0901026319	536	0901056056	529
630570000	477	630841000	472	631080000	409	631289000	357	631599000	372	631827000	292	631930000	305	635167000	249	642396000	249	685139000	66	0901026327	524	0901056161	529
630571000	477	630850000	448	631093000	409	631317000	440	631618000	311	631828000	292	631931000	305	635168000	249	657006000	579	685140000	66	0901026351	532	0901056218	529
630572000	477	630851000	448	631094000	411	631327000	449	631660000	372	631829000	292	631932000	411	635169000	249	657007000	579	690073000	593	0901026360	532	0901056226	529
630573000	477	630852000	448	631095000	409	631333000	449	631670000	575	631830000	292	631933000	467	635250000	248	685038000	65	690074000	593	0901026378	536	0901057290	529
630574000	477	630853000	448	631096000	409	631337000	462	631703000	295	631831000	292	631934000	467	635252000	248	685039000	65	690076000	594	0901026386	536	0901057303	529
630576000	477	630854000	448	631097000	411	631340000	401	631704000	295	631832000	292	631935000	466	635253000	248	685048000	74	690077000	594	0901026408	524	0901058903	529
630577000	477	630855000	448	631098000	411	631341840	78	631705000	295	631833000	292	631936000	466	635254000	248	685049000	74	690078000	594	0901026521	524	0901059489	528
630578000	477	630858000	448	631110000	208	631341890	78	631706000	295	631834000	292	631937000	467	635255000	248	685050000	74	690080000	594	0901026530	524	0901059500	528
630579000	294	630859000	159	631111000	208	631343000	274	631707000	295	631835000	292	631938000	372	635302000	248	685051000	74	690081000	594	0901026548	524	0901059691	527
630580000	293	630867000	463	631112000	208	631345000	467	631708000	295	631836000	292	631939000	402	635304000	248	685053000	65	690083000	593	0901026572	524	0901062145	529
630581000	293	630868000	464	631114000	359	631348000	466	631709000	295	631837000	292	631940000	464	636215000	246	685054000	65	690084000	593	0901026645	531	0901063087	524
630584000	293	630885000	478	631120000	413	631349000	466	631710000	295	631838000	292	631943000	305	636216000	246	685061000	74	690085000	594	0901026653	531	0901063095	524
630589000	293	630886000	478	631122000	413	631360000	172	631711000	295	631839000	292	631945000	209	636217000	246	685062000	75	690086000	593	0901026661	521	0901063109	524
630590000	293	630887000	478	631125000	411	631362000	462	631712000	295	631840000	292	631946000	209	636219000	77	685063000	75	690101000	596	0901026777	536	0901063788	526
630592000	477	630889000	478	631129000	409	631363000	463	631713000	295	631841000	292	631947000	209	636225000	246	685064000	75	690103000	595	0901026807	536	0901063796	526
630593000	477	630891000	478	631130000	409	631364000	463	631715000	293	631842000	292	631948000	209	636226000	246	685065000	75	690104000	595	0901026815	521	0901063800	526
630632000	220	630895000	471	631137000	414	631365000	463	631720000	372	631843000	292	631949000	209	636227000	246	685066000	74	690105000	596	0901026858	517	0901063818	526
630633000	220	630896000	471	631139000	413	631370000	462	631751000	462	631844000	292	631967000	467	636241000	246	685067000	74	690106000	595	0901026866	517	0901063826	525
630634000	220	630897000	463	631144000	414	631382000	578	631752000	462	631845000	292	631968000	306	636242000	246	685068000	75	690424000	593	0901026882	517	0901063834	525
630635000	220	630898000	463	631146000	414	631387000	301	631753000	467	631846000	292	631980000	358	636243000	246	685069000	75	690425000	596	0901026904	517	0901063850	525
630636000	220	630901000	477	631150000	344	631388000	301	631754000	466	631847000	292	631981000	358	636321000	247	685074000	75	0901004170	525	0901031517	531	0901063869	525
630637000	220	630902000	477	631156000	344	631407000	411	631756000	471	631848000	292	631984000	412	636322000	247	685077000	75	0910057553	440	0901031550	521	0901063877	525
630638000	220	630903000	477	631158000	344	631420000	301	631757000	466	631849000	292	631985000	412	636323000	247	685081000	65	0901008540	524	0901053715	514	0901063885	525
630649000	77	630904000	477	631166000	165	631421000	301	631758000	357	631850000	292	631986000	412	636333000	247	685082000	65	0901					

Order No.	Page	Order No.	Page	Order No.	Page
0903050306	564	0909060354	449	7802009105	531
0903050314	564	0910031260	471	7803009117	532
0903053143	559	0910053353	443	7803009125	533
0903058005	565	0910057553	440	7803009133	532
0903060778	567	0910058010	471	7803009141	533
0903061200	561	0910058967	440	7804009161	533
0903061219	561	0910059955	471	7804010372	533
0903061227	561	0910063707	439	7804065606	533
0903061235	561	0910064312	439	7805009300	535
0903061243	563	0910064347	439	7805009319	535
0903061251	563	0910064363	439	7805009343	535
0903061260	562	0910064371	439	7805009351	535
0903061278	562	0910064401	439	7805009416	535
0903061294	560	0911001071	443	7805009432	535
0903061316	565	0911014220	452	7805009440	535
0903061340	566	0911016362	452	7805009459	535
0903061359	562	0911018691	443	7805009475	535
0903061367	562	0911030713	452	7805009483	535
0903061375	560	0911030721	452	7805033767	535
0903061677	559	0911030730	452	7806009185	534
0903061685	559	0911030748	452	7806009207	534
0903063122	567	0911030845	452	7806034996	534
0903063130	567	0911050390	452	7807009367	536
0903063149	567	0911053179	452	7807009375	536
0903064838	559	0911060167	452	7808009247	534
0903064846	559	0911062119	452	7809009275	535
0903064854	559	0911063549	452	7809009283	535
0909000416	448	0913005058	470	7809009291	535
0909000424	448	0913007123	470	7809035764	535
0909029171	448	0913010779	471	7823672327	521
0909029180	448	0913013565	471	7851194171	527
0909029210	448	0913013581	470	7851194180	527
0909029228	448	0913014626	470	7854112915	471
0909029244	448	0913014634	470	7854115035	471
0909029252	448	0913017617	470	7876193943	527
0909029260	448	0913031270	472	7876193951	527
0909029279	448	0913031288	471	7876193978	528
0909030528	449	0913031296	472	7876193986	528
0909030536	449	0913031300	472	7876193994	528
0909030544	449	0913059433	471	7876194001	527
0909030552	449	0913059441	470	7876194010	527
0909031249	449	0920016529	470	7876194028	527
0909040817	448	0920054030	452	7876194060	527
0909040825	448	0920054048	452	7876194079	527
0909040841	448	1001672319	521	7876194117	528
0909052939	448	1319706247	524	7876194125	527
0909057175	448	4313062258	443	7876194133	527
0909057183	448	6109079322	527	7876693610	528
0909057191	448	7710672339	521	7876693628	528
0909060257	448	7800009035	532	9109691680	528
0909060265	448	7800009043	532		
0909060273	448	7800009558	532		
0909060281	448	7801009055	531		
0909060303	449	7801009063	531		
0909060320	449	7801009071	531		
0909060338	449	7802009083	531		
0909060346	449	7802009091	531		

## **Metabo - always close by.**

With 2,000 employees, 25 subsidiary sales companies and 100 importers on all continents, we have a global presence on site - and always there whenever and wherever you need us.

654456800/0518



### **Germany**

Metabowerke GmbH  
Metabo-Allee 1  
72622 Nürtingen  
Tel.: +49 (0)7022 72-0

### **United Kingdom**

Metabo (UK) Ltd  
25 Majestic Road,  
Nursling Industrial Estate  
Southampton SO16 0YT  
Tel.: +44 (0) 2380 732000

### **Metabo Power Tools SA (Pty) Ltd**

P.O.Box 4360  
Edenvale 1610  
Gauteng  
South Africa  
Tel.: +27 87 808 2200  
Fax: +27 11 453 4163

### **Middle East**

Metabo (Branch)  
Office No. 423, Block 4EA  
Dubai Airport Freezone  
Tel.: +971 4 7017325

### **Australia**

Metabo Pty. Ltd  
10 Dalmore Drive  
Scoresby, Victoria 3179  
Tel.: (+61) 3 - 97 65 01 99  
Fax: (+61) 3 - 97 65 01 89

### **China**

Metabo Powertools (China) Co. Ltd.  
Bldg. 7, 3585 San Lu Road  
Pujiang Industrial Park  
Min Hang District  
Shanghai 201114  
Tel.: (+86) 21 - 24 16 2688  
Fax: (+86) 21 - 64 29 2999

**As of 05/2018**

[www.metabo.com](http://www.metabo.com)

# **metabo**<sup>®</sup>

**PROFESSIONAL POWER TOOL SOLUTIONS**

## X-ON Electronics

Largest Supplier of Electrical and Electronic Components

*Click to view similar products for [Hand Tools](#) category:*

*Click to view products by [Metabo](#) manufacturer:*

Other Similar products are found below :

[58284-1](#) [59773-1](#) [662908-1](#) [68764-0001](#) [690619-6](#) [7-354778-7](#) [768531-1](#) [810131](#) [81541-16](#) [854183-1](#) [854358-1](#) [90855-1](#) [992258-1](#) [1-21046-3](#) [121073-0047](#) [1-22278-0](#) [1-22278-2](#) [1-24954-2](#) [125529-5](#) [126513-1](#) [1-305579-8](#) [1-306027-0](#) [1338968-2](#) [1-354779-0](#) [1-354779-2](#) [1-354779-4](#) [1424443-1](#) [1424266-1](#) [1424289-1](#) [1424444-1](#) [1532195-2](#) [1538773-2](#) [1-692134-3](#) [HT-920A-124-HTELE-RPL-KIT](#) [1976923-1](#) [1976969-1](#) [2063795-1](#) [2-21002-1](#) [2-21002-4](#) [2-21002-7](#) [2-21002-9](#) [229707-1](#) [911737-2](#) [91348-2](#) [925980-R](#) [301185-9](#) [983533-1](#) [1-694433-7](#)  
[AD-1547-1-INSTALL-TOOL](#) [189766-1](#)