

**FEATURES**

- Winding type realizes small size and low profile
- Prevention of common mode noise at high frequency
- Excellent solderability
- Operating temperature -40~+125℃ (Including self - temperature rise)
- RoHS Compliant

**FEATURES**

- Power line noise countermeasure for electronic equipment (Notebook, server applications, Battery , etc.)
- Best for high current circuit such as car
- Wireless charging and power device design

**Explanation of Part Number**
**ACM 7060 F- 701 T40**
**1 2 3 4 5 6**

- ◆ 1:Product Series:Wire Wound Common Mode Chokes
- ◆ 2:Dimensions:
- ◆ 3: Material Code:Ferrite
- ◆ 4:Common Mode Impedance( $\Omega$ )
- ◆ 5:Packing(Tape & Reel)
- ◆ 6:Rated Current:40=4.0A

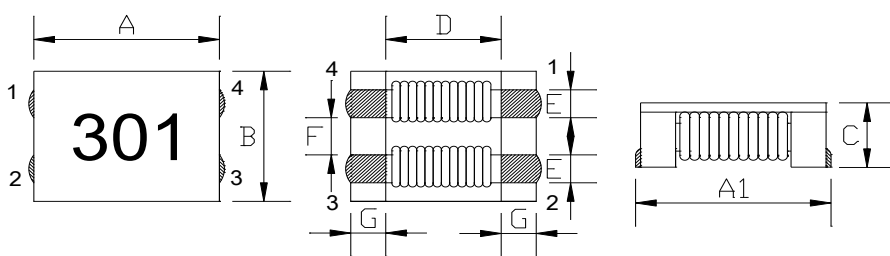
**Shapes and Dimensions [Dimensions in mm]**

<b>A:</b>	<b>7.0±0.5</b>	<b>mm</b>
<b>A1:</b>	<b>7.5±0.5</b>	<b>mm</b>
<b>B:</b>	<b>6.0±0.5</b>	<b>mm</b>
<b>C:</b>	<b>3.8Max.</b>	<b>mm</b>
<b>D:</b>	<b>3.5Typ.</b>	<b>mm</b>
<b>E:</b>	<b>1.5±0.2</b>	<b>mm</b>
<b>F:</b>	<b>1.5±0.2</b>	<b>mm</b>
<b>G:</b>	<b>1.75±0.2</b>	<b>mm</b>

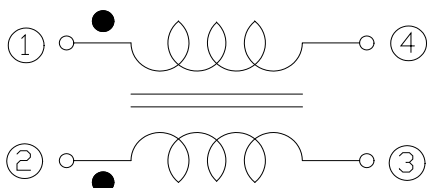
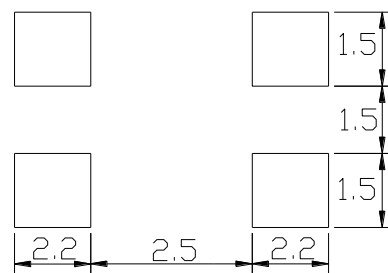
**Equivalent circuit**

**Land Pattern: [mm]**

## Electrical Characteristics:

PT/NO.	Impedance( $\Omega$ ) at 100MHz		Resistance RDC( $\Omega$ ) Max.(1 line)	Rated Current (A) Max.	Insulation Resistance (M $\Omega$ ) Min.	Rated Voltage (V)Max.
	Min.	Typ.				
ACM7060F-400T150	40	70	5m	15	10	125
ACM7060F-101T90	100	140	10m	9.0	10	125
ACM7060F-301T50	225	300	10m	5.0	10	125
ACM7060F-501T50	275	350	10m	5.0	10	125
ACM7060F-601T40	500	700	15m	4.0	10	125
ACM7060F-701T40	500	700	15m	4.0	10	125
ACM7060F-102T30	800	1020	17m	3.0	10	125
ACM7060F-132T25	910	1300	21m	2.5	10	125
ACM7060F-272T10	2000	2700	63m	1.0	10	125
ACM7060F-302T09	2500	3000	75m	0.9	10	125

Rated Current : Based on temperature rise ( $\Delta T$  : 40°C TYP.)

## TYPICAL ELECTRICAL CHARACTERISTICS

### Impedance VS. Frequency

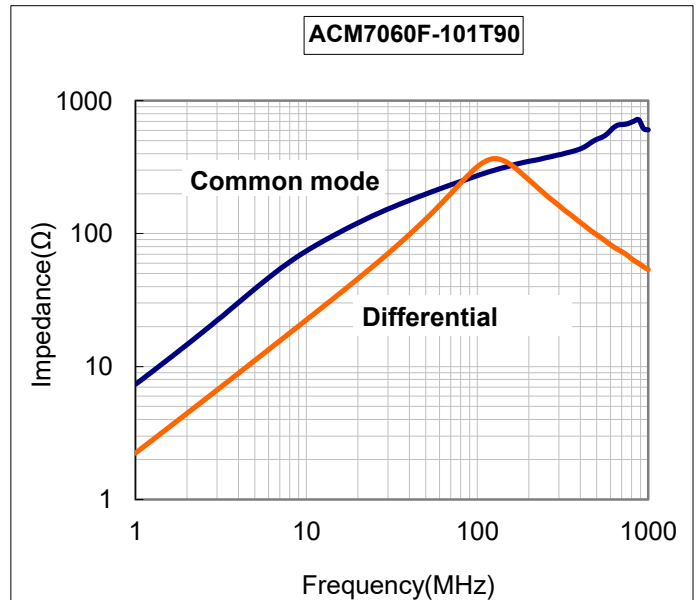
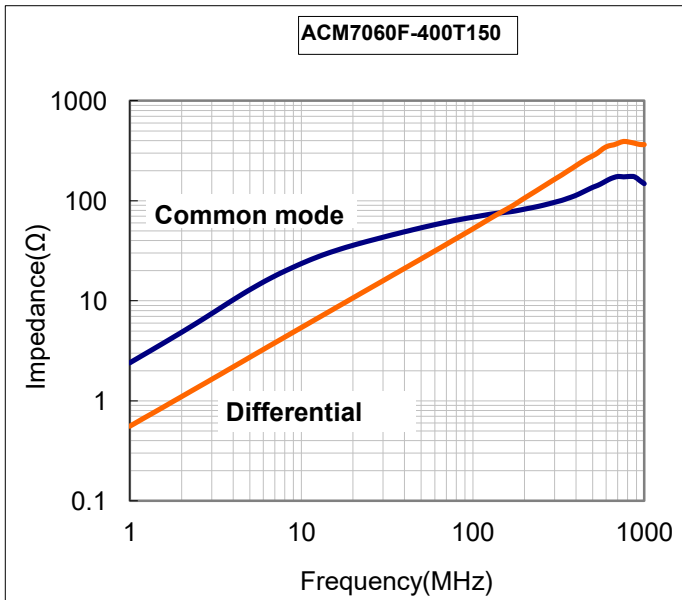

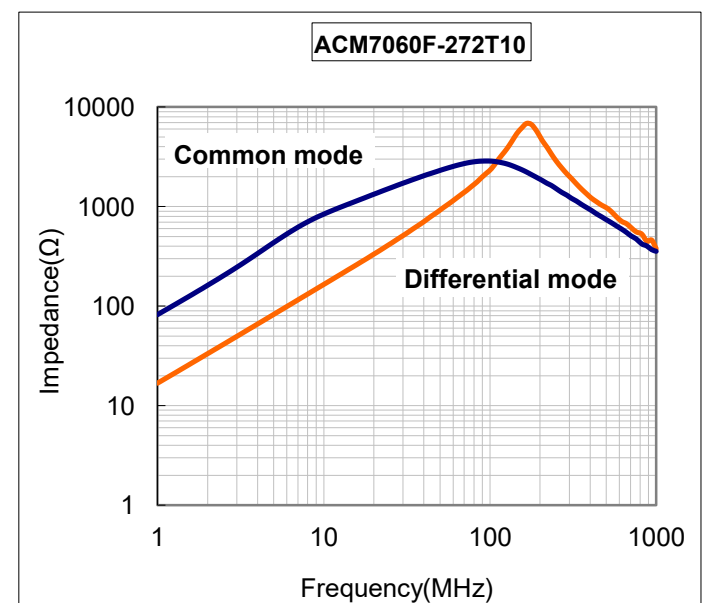
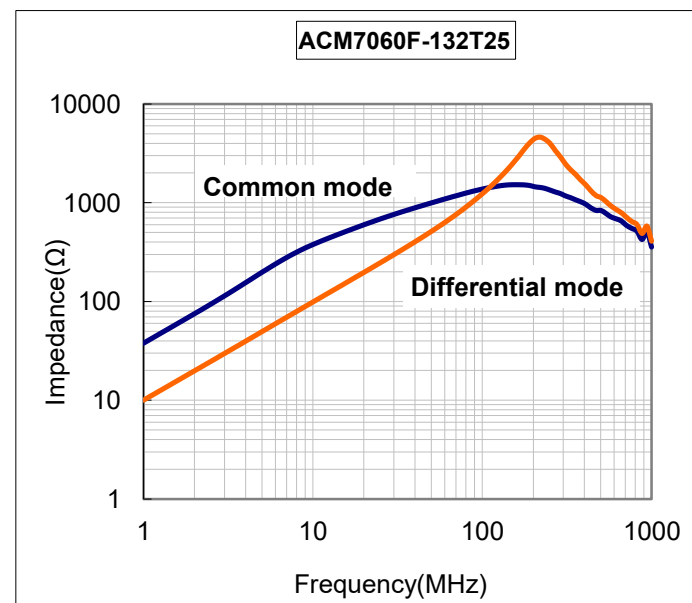
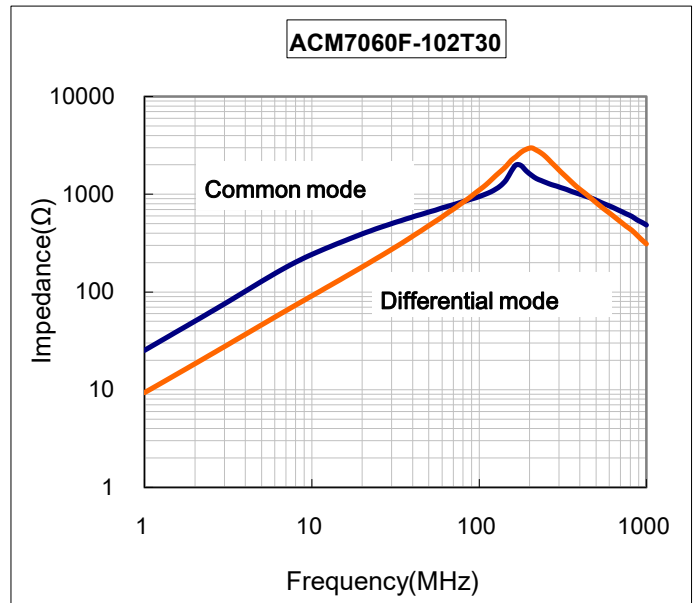
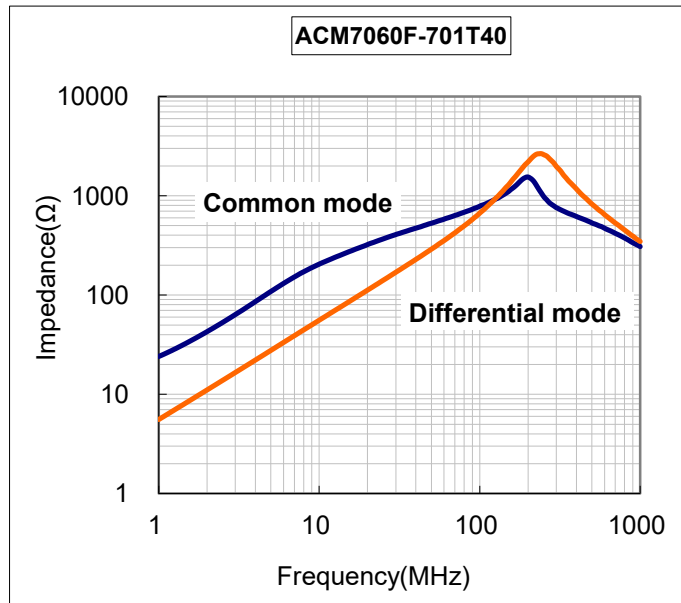
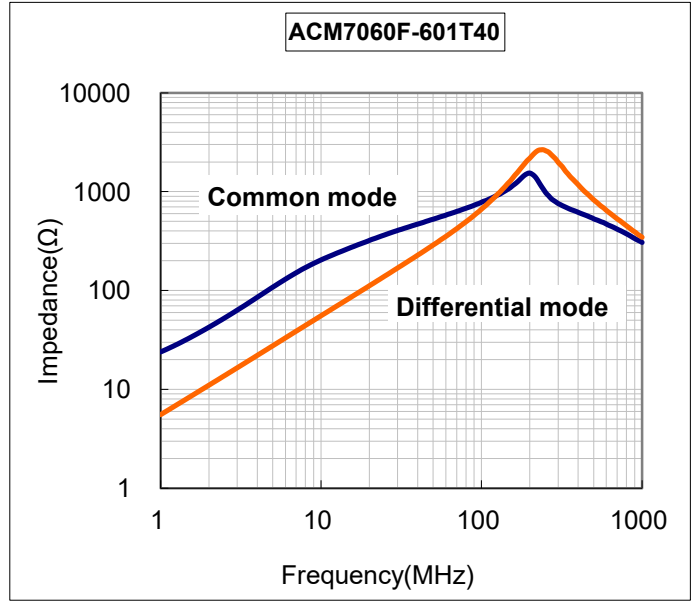
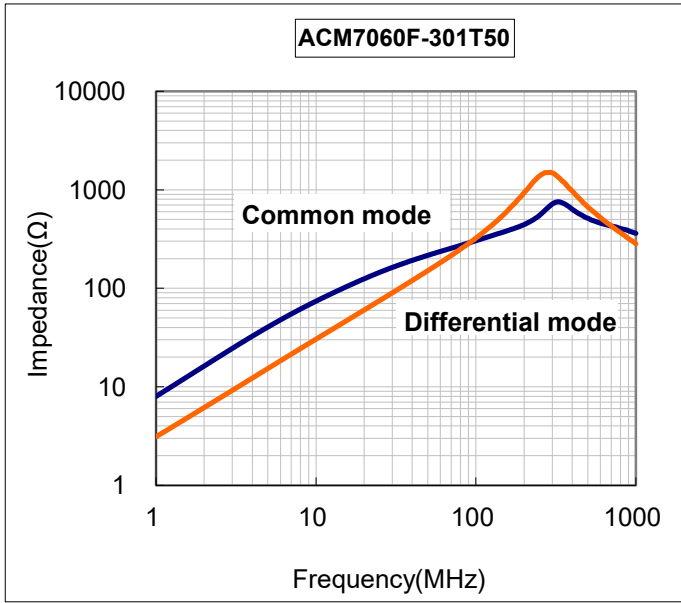

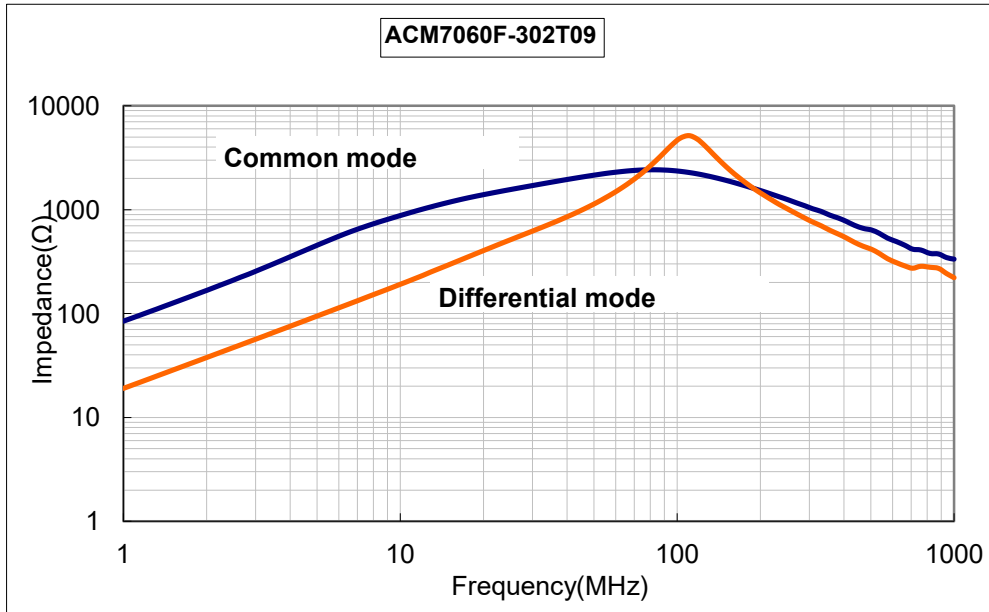

## TEST EQUIPMENT

### Impedance

Measured by using HP4291B RF Impedance Analyzer.

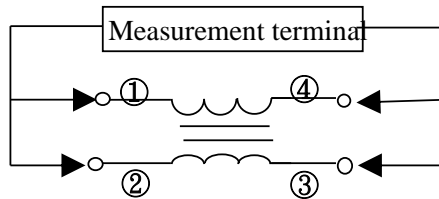

### DC Resistance

Measured by using Chroma 16502 milliohm meter.

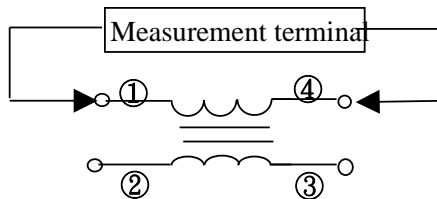

### Insulation Resistance

Measured by using Chroma 19073

Measurement voltage : 50v , Measurement time : 60 sec.

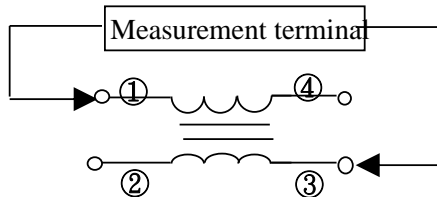

# Reliability Test

## MECHANICAL

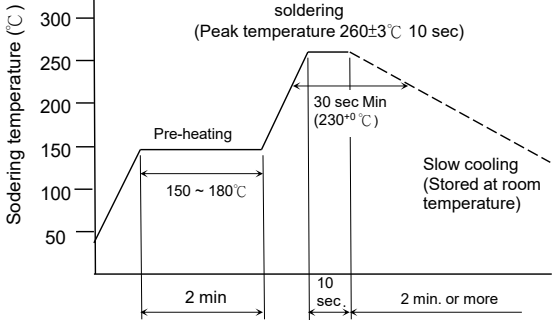
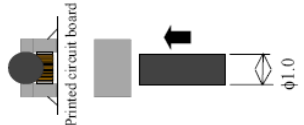
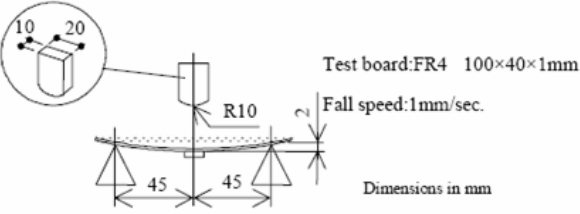
TEST ITEM	SPECIFICATION	TEST DETAILS
Solder ability	The product shall be connected to the test circuit board by the fillet (the height is 0.2mm).	Apply cream solder to the printed circuit board . Refer to clause 8 for Reflow profile.
Resistance to Soldering heat (reflow soldering)	There shall be no damage or problems.	<p><b>Temperature profile of reflow soldering</b></p>  <p>The specimen shall be passed through the reflow oven with the condition shown in the above profile for 1 time. The specimen shall be stored at standard atmospheric eric conditions for 1 hour, after which the measurement shall be made.</p>
Terminal strength	The terminal electrode and the ferrite must not be damaged.	<p>Solder a chip to test substrate , and then laterally apply a load 9.8N in the arrow direction.</p> 
Strength on PC board bending	The terminal electrode and the ferrite must not be damaged.	<p>Solder a chip to test substrate and then apply a load.</p>  <p>Test board:FR4 100×40×1mm Fall speed:1mm/sec. Dimensions in mm</p>
High temperature resistance	<p>Impedance:Within±20% of the initial value.</p> <p>Insulation resistance and DC resistance on the specification(refer to clause 2-1) shall be met.</p> <p>The terminal electrode and the ferrite must not be damaged.</p>	<p>After the samples shall be soldered onto the test circuit board,the test shall be done.</p> <p>Measurement : After placing for 24 hours min.</p> <p>Temperature : +125±2°C</p> <p>Applied voltage : Rated voltage</p> <p>Applied current : Rated current</p> <p>Testing time : 500±12 hours</p>

## MECHANICAL

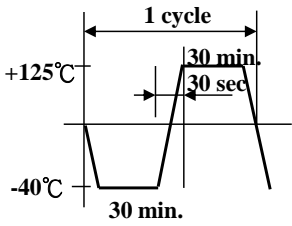
TEST ITEM	SPECIFICATION	TEST DETAILS
Humidity resistance	<p>Impedance: Within <math>\pm 20\%</math> of the initial value.</p> <p>Insulation resistance and DC resistance on the specification (refer to clause 2-1) shall be met.</p> <p>The terminal electrode and the ferrite must not be damaged.</p>	<p>After the samples shall be soldered onto the test circuit board, the test shall be done.</p> <p>Measurement : After placing for 24 hours min.</p> <p>Temperature : <math>+60 \pm 2^\circ\text{C}</math> , Humidity : 90 to 95 %RH</p> <p>Applied voltage : Rated voltage</p> <p>Applied current : Rated current</p> <p>Testing time : <math>500 \pm 12</math> hours</p>
Thermal shock	<p>Impedance: Within <math>\pm 20\%</math> of the initial value.</p> <p>Insulation resistance and DC resistance on the specification (refer to clause 2-1) shall be met.</p> <p>The terminal electrode and the ferrite must not be damaged.</p>	
Low temperature storage	<p>Impedance: Within <math>\pm 20\%</math> of the initial value.</p> <p>Insulation resistance and DC resistance on the specification (refer to clause 2-1) shall be met.</p> <p>The terminal electrode and the ferrite must not be damaged.</p>	<p>After the samples shall be soldered onto the test circuit board, the test shall be done.</p> <p>Measurement : After placing for 24 hours min.</p> <p>Temperature : <math>-40 \pm 2^\circ\text{C}</math></p> <p>Testing time : <math>500 \pm 12</math> hours</p>
Vibration	<p>Impedance: Within <math>\pm 20\%</math> of the initial value.</p> <p>Insulation resistance and DC resistance on the specification (refer to clause 2-1) shall be met.</p> <p>The terminal electrode and the ferrite must not be damaged.</p>	<p>After the samples shall be soldered onto the test circuit board, the test shall be done.</p> <p>Frequency : 10 to 55 Hz</p> <p>Amplitude : 1.52 mm</p> <p>Dimension and times : X ,Y and Z directions for 2 hours each.</p>
Solderability	<p>New solder More than 75%</p>	<p>Flux (rosin, isopropyl alcohol {JIS-K-1522}) shall be coated over the whole of the sample before hand, the sample shall then be preheated for about 2 minutes in a temperature of <math>130 \sim 150^\circ\text{C}</math> and after it has been immersed to a depth 0.5mm below for <math>3 \pm 0.2</math> seconds fully in molten solder M705 with a temperature of <math>245 \pm 2^\circ\text{C}</math>. More than 75% of the electrode sections shall be covered with new solder smoothly when the sample is taken out of the solder bath.</p>

## Packaging

### CARRIER TAPE DIMENSIONS (mm)

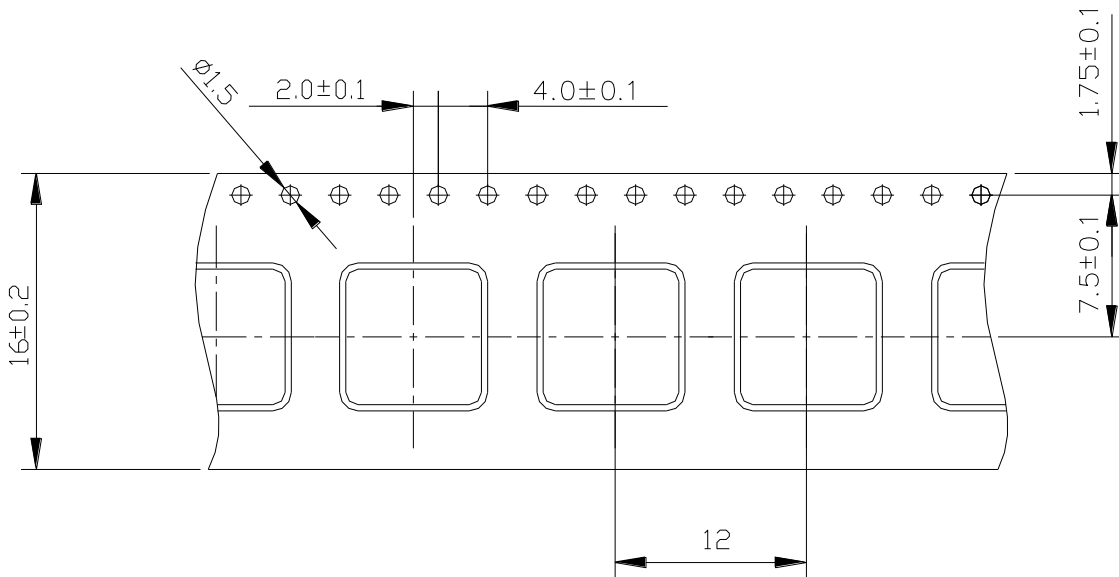

### TAPING DIMENSIONS (mm)

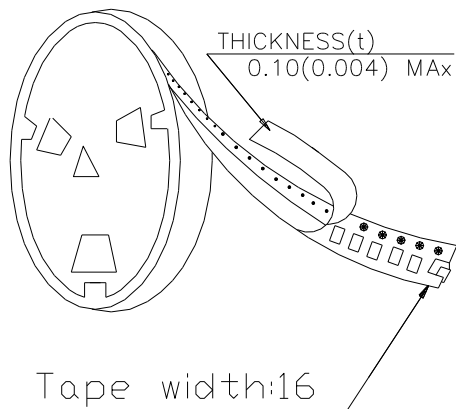
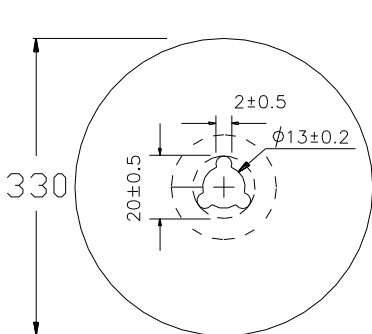
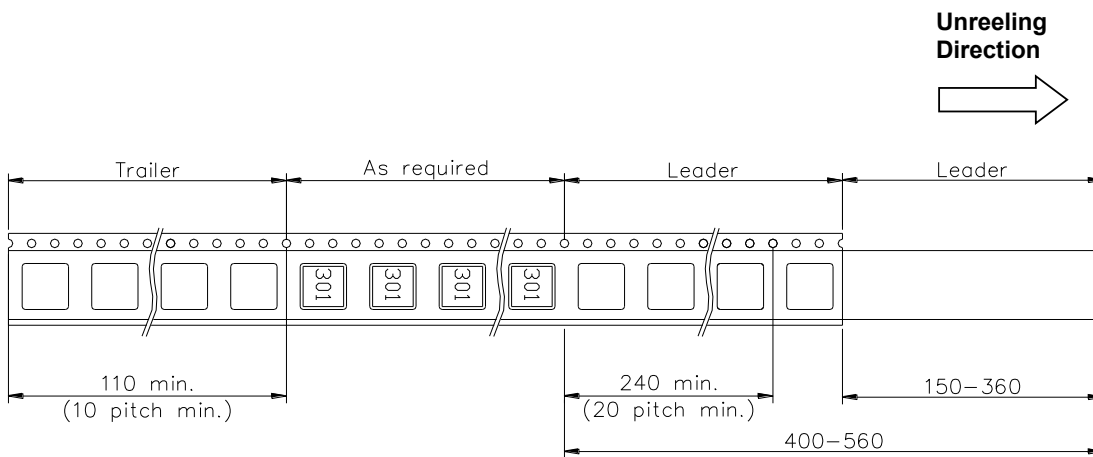

### Packing Quantity

1500 pcs./reel

## X-ON Electronics

Largest Supplier of Electrical and Electronic Components

*Click to view similar products for [Common Mode Chokes / Filters](#) category:*

*Click to view products by [MetalLions](#) manufacturer:*

Other Similar products are found below :

[PE-64683](#) [RD5122-6-9M6](#) [RD6137-6-7M5](#) [RD8147-16-3M0](#) [ST6118T-R](#) [FE3X025-10-7NL](#) [RD7147-25-0M7](#) [TCM0806G-350-2P-T](#)  
[TCM0806G-650-2P-T](#) [IND-0110](#) [UAL21VR0802000](#) [UALSC023000000](#) [UALSC1020JH000](#) [UALSU10VD20010](#) [UALSU9VD070100](#) [36-00037](#) [UALW21HS072450](#) [UALSU9H0208000](#) [UAL24VK06450CH](#) [PLT10HH501100PNB](#) [PLT10HH401100PNB](#) [PLT10HH1026R0PNB](#)  
[36-00029-01](#) [PE-67531](#) [TLH10UB](#) [113 0R5](#) [2752045447](#) [7351V](#) [CMF16-153131](#) [RD7147-6-6M0](#) [T8116NLT](#) [FE2X10-4-2NL](#) [36-00029-07](#)  
[T8003NLT](#) [CTX01-13663](#) [CTX66-19521-R](#) [RC212-0.5-10M](#) [RC112-0.4-15M](#) [RC212-0.6-6M8](#) [RC212-0.4-15M](#) [RC112-0.3-30M](#)  
[WTCF2012Z0M751PB](#) [PH9408.814NLT](#) [PAC6006.364NLT](#) [PAC6006.444NLT](#) [PAC6006.204NLT](#) [PH9407.204NLT](#) [PAC6006.264NLT](#)  
[PH9408.105NLT](#) [PH9408.494NLT](#) [PAC6006.104NLT](#)