

## MCMB-0630 Series

### High Current Molded Power Inductors

#### FEATURES

- Powder iron core material
- Magnetically shielded, low EMI
- High current carrying capacity, Low core losses
- Frequency range up to 3MHz
- Operate temperature range ....  $-40^{\circ}\text{C} \sim +125^{\circ}\text{C}$  (Including self temp. rise)
- RoHS compliant

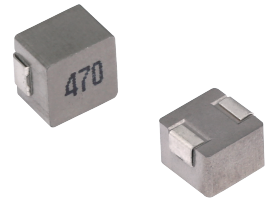

#### APPLICATIONS

- Voltage Regulator Module (VRM)
- Multi-phase regulators
- Point-of-load modules
- Smart phone POL modules
- SSD modules
- Notebook regulators
- Battery power systems
- Graphics cards
- Data networking and storage systems

#### Explanation of Part Number

MCMB -0630 -1R0 M T

1 2 3 4 5

- ◆ 1:Product Series:Metal Alloy Molding Power Inductor
- ◆ 2:Dimensions:
- ◆ 3: Initial inductance value: 1R0 = 1.0uH
- ◆ 4:Tolerance of Inductance:M:±20%
- ◆ 5:Packing:Tape Carrier Package

### Dimensions: [mm]

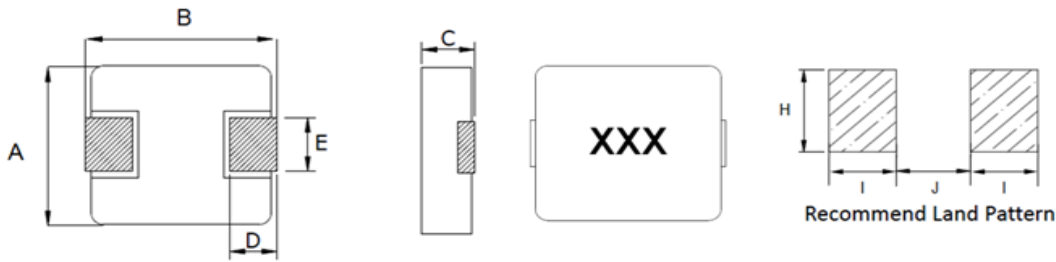

Series	A	B	C	D	E	I Typ.	J Typ.	H Typ.
MCMB-0630	6.6±0.2	7.0±0.3	2.8±0.2	1.6±0.3	3.0±0.3	2.35	3.7	3.5

### Electrical Properties:

Part Number	Inductance	DC Resistance	Saturation Current		Heat Rating Current	
	@100KHz, 1V	Max.	Max.	Typ.	Max.	Typ.
Units	μH	mΩ	A		A	
Symbol	L	DCR	Isat		Irms	
MCMB-0630-R10MT	0.10±20%	1.7	53.0	60.0	28.5	32.5
MCMB-0630-R12MT	0.12±20%	0.77±7%	30.0	40.0	32.0	38.0
MCMB-0630-R22MT	0.22±20%	3	27.2	34.0	21.0	24.0
MCMB-0630-R24MT	0.24±20%	3.1	22.4	28.0	18.4	23.0
MCMB-0630-R33MT	0.33±20%	3.5	20.0	25.0	19.0	21.0
MCMB-0630-R47MT	0.47±20%	4.1	16.0	20.0	16.5	18.0
MCMB-0630-R56MT	0.56±20%	4.5	14.4	18.0	15.0	16.5
MCMB-0630-R68MT	0.68±20%	5.3	13.6	17.0	14.5	16.0
MCMB-0630-R82MT	0.82±20%	6.0	12.8	16.0	12.5	14.0
MCMB-0630-1R0MT	1.0±20%	7.4	12.0	15.0	10.5	12.0
MCMB-0630-1R5MT	1.5±20%	12.1	9.60	12.0	10.5	12.0
MCMB-0630-1R8MT	1.8±20%	12.6	9.40	11.8	8.20	9.30
MCMB-0630-2R2MT	2.2±20%	15	8.00	10.0	8.50	9.50
MCMB-0630-3R3MT	3.3±20%	22	7.60	9.50	7.50	8.50
MCMB-0630-4R7MT	4.7±20%	33	7.20	9.00	5.00	6.00
MCMB-0630-5R6MT	5.6±20%	42	5.20	6.50	4.80	5.50
MCMB-0630-6R8MT	6.8±20%	48	4.80	6.00	4.20	5.00
MCMB-0630-8R2MT	8.2±20%	60	4.40	5.50	4.20	5.00
MCMB-0630-100MT	10±20%	68	4.40	5.50	3.80	4.50
MCMB-0630-150MT	15±20%	113	3.20	4.00	2.30	3.00
MCMB-0630-220MT	22±20%	170	2.40	3.00	2.00	2.50
MCMB-0630-330MT	33±20%	270	2.00	2.50	1.60	2.00
MCMB-0630-470MT	47±20%	385	1.60	2.00	1.20	1.50

#### Notes

- ※1: All test data is referenced to 20°C ambient;
- ※2: Rated current: Isat or Irms, whichever is smaller;
- ※3: Isat(Typ): DC current at which the inductance drops approximate 30% from its value without current;
- ※4: Isat(Max): DC current at which the inductance drops approximate 20% from its value without current;
- ※5: Irms(Typ): DC current that causes the temperature rise (ΔT =40°C) from 20°C ambient.
- ※6: Irms(Max): DC current that causes the temperature rise (ΔT =20°C) from 20°C ambient.
- ※7: Absolute maximum voltage 30VDC

## TYPICAL ELECTRICAL CHARACTERISTICS

**MCMB-0630-R10MT**

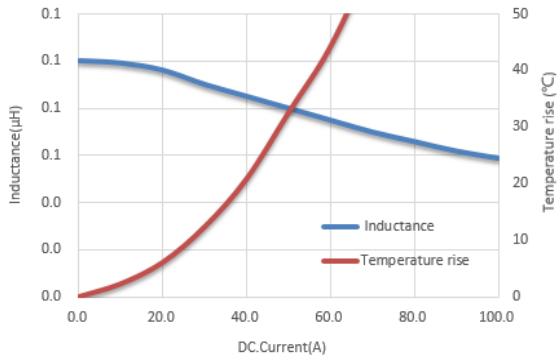

**MCMB-0630-R22MT**

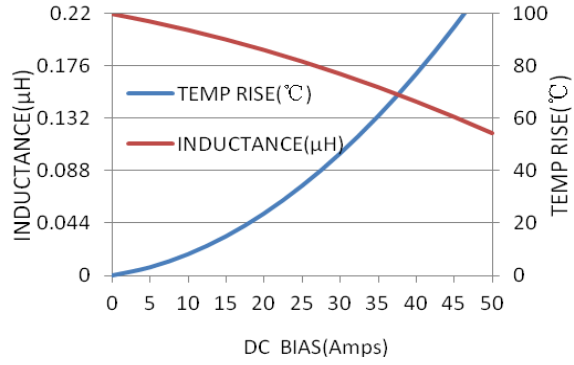

**MCMB-0630-R33MT**

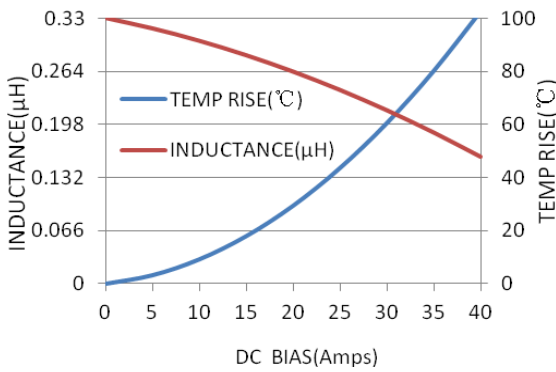

**MCMB-0630-R47MT**

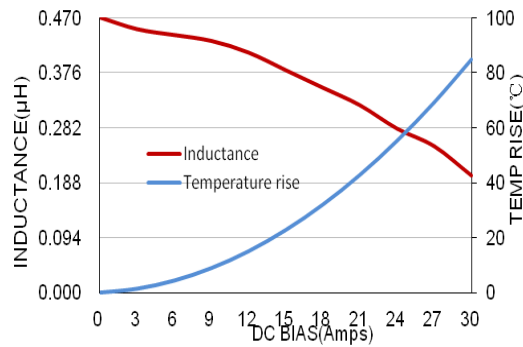

**MCMB-0630-R56MT**

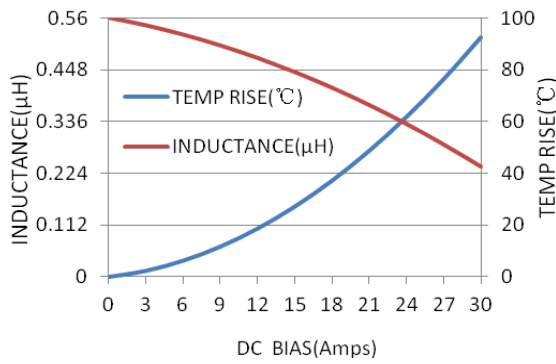

**MCMB-0630-R68MT**

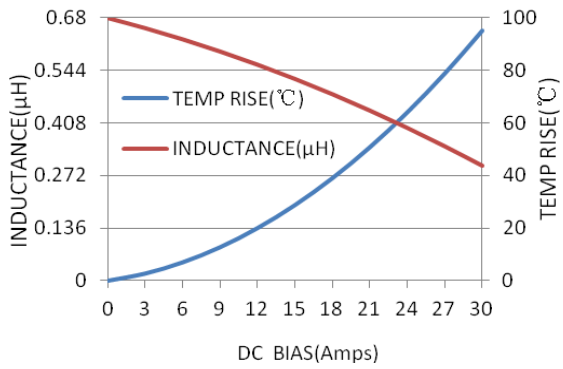

**MCMB-0630-R82MT**

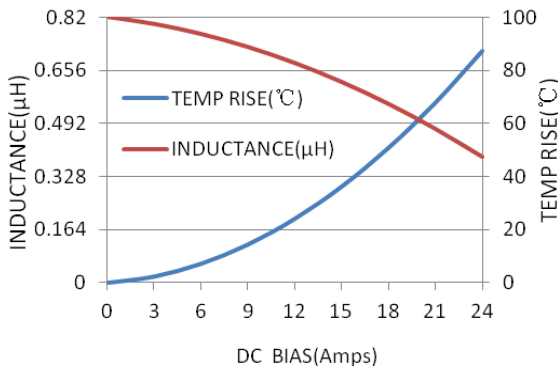

**MCMB-0630-1R0MT**

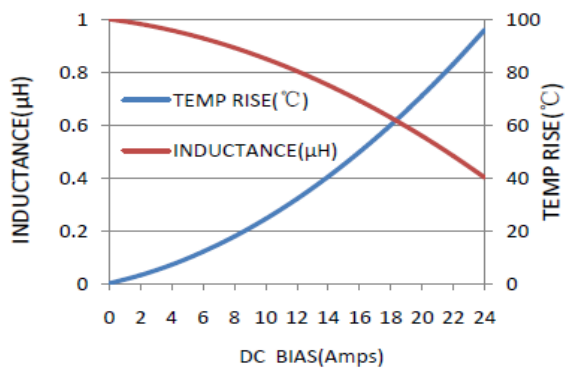

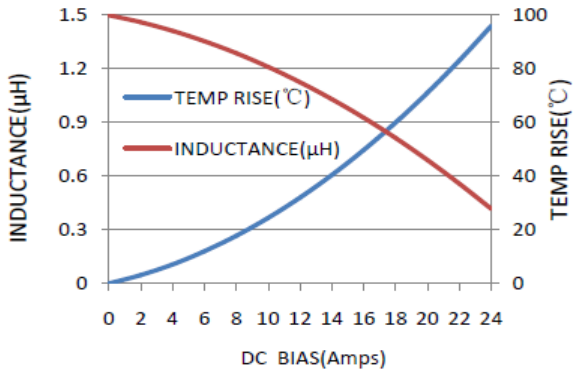
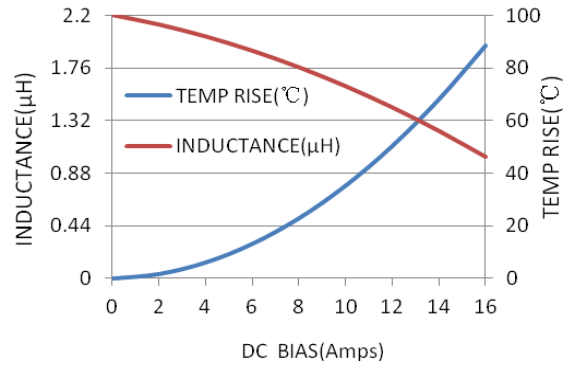
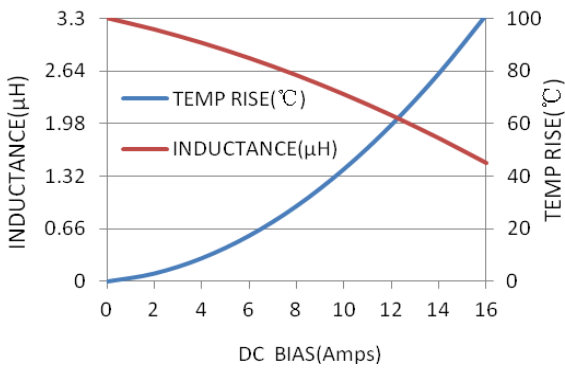
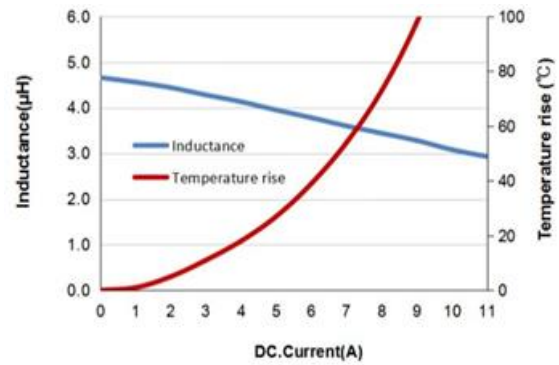
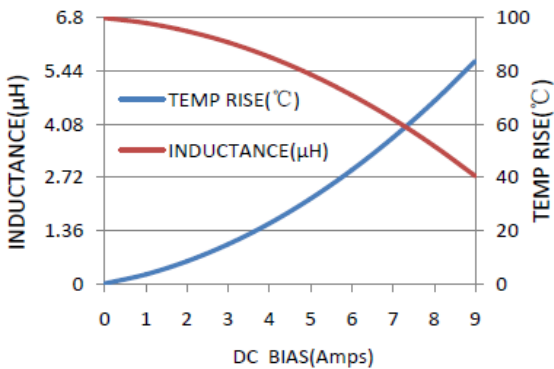
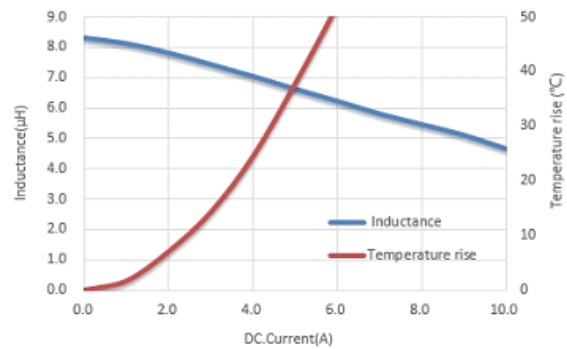
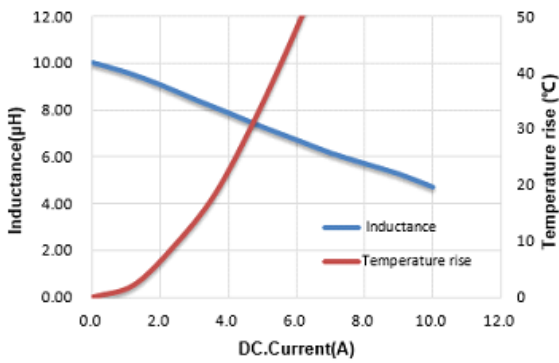
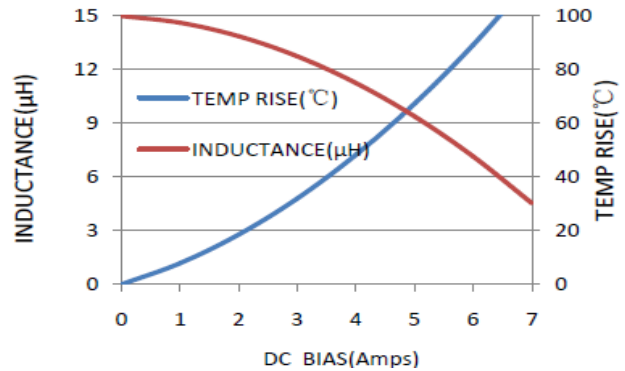
**MCMB-0630-1R5MT**

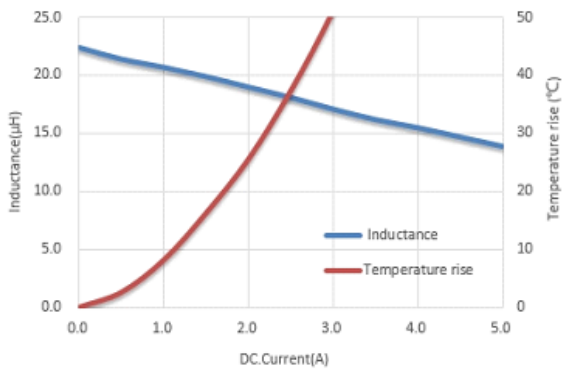
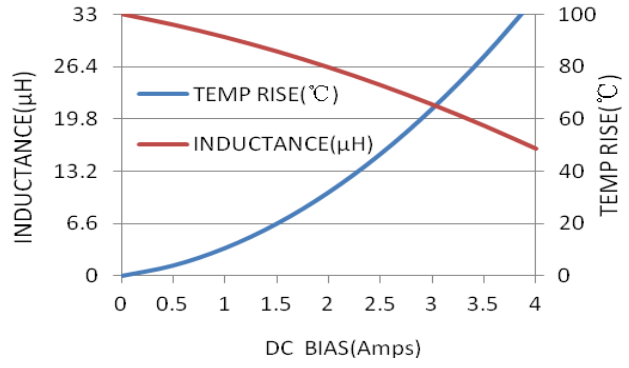
**MCMB-0630-2R2MT**

**MCMB-0630-3R3MT**

**MCMB-0630-4R7MT**

**MCMB-0630-6R8MT**

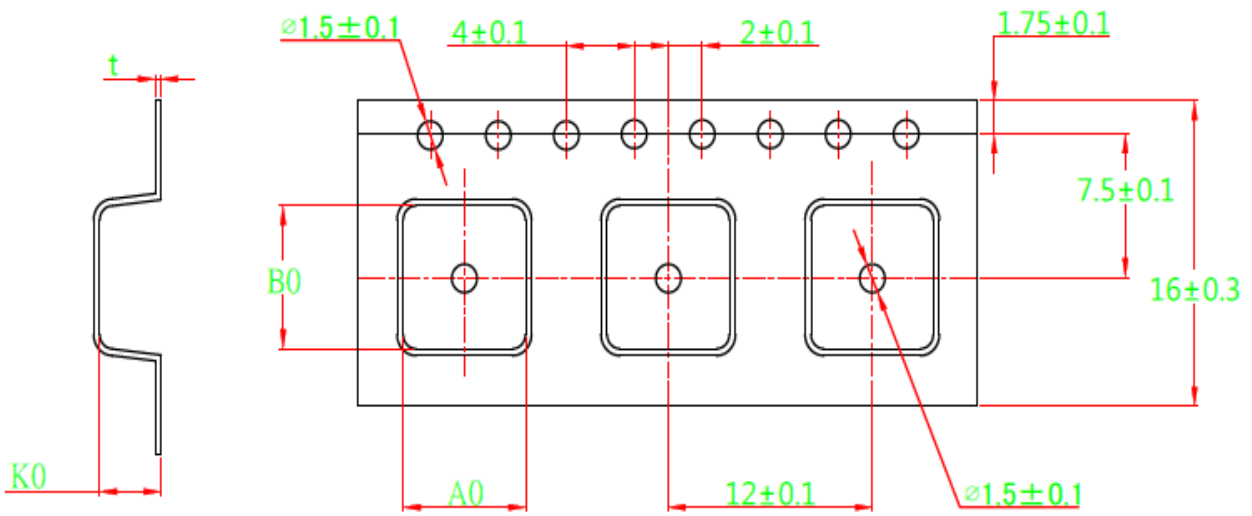
**MCMB-0630S-8R2MT**

**MCMB-0630-100MT**

**MCMB-0630-150MT**

**MCMB-0630-220MT**

**MCMB-0630-330MT**

## Reliability and Test Condition

Mechanical Reliability		
Item	Specification and Requirement	Test Method
Solderability	The surface of terminal immersed shall be minimum of 95% covered with a new coating of solder	Solder heat proof: 1. Preheating: $160 \pm 10$ °C 2. Retention time: $245 \pm 5$ °C for $2 \pm 0.5$ seconds
Vibration	Inductance change: Within $\pm 10\%$ Without mechanical damage such as break	1. Vibration frequency: (10 Hz to 55 Hz to 10Hz) in 60 seconds as a period 2. Vibration time: Period cycled for 2 hours in each of 3 mutual perpendicular directions. 3. Amplitude: 1.5 mm max.
Shock	Inductance change: Within $\pm 10\%$ Without mechanical damage such as break	1. Peak value: 100 G 2. Duration of pulse: 11ms 3. 3 times in each positive and negative direction of 3 mutual perpendicular directions
Endurance Reliability		
Item	Specification and Requirement	Test Method
Thermal Shock	Inductance change: Within $\pm 10\%$ Without distinct damage in appearance	1. Repeat 100 cycles as follow: ( $-55 \pm 2$ °C; $30 \pm 3$ min) →(Room temp., 5 min) → ( $+125 \pm 2$ °C, $30 \pm 3$ min) → (Room temp., 5 min) 2. Recovery: $48 + 4 / -0$ hours of recovery under the standard condition after the test.
High Temperature Resistance	Inductance change: Within $\pm 10\%$ Without distinct damage in appearance	1. Environment condition: $85 \pm 2$ °C Applied Current: Rated current 2. Duration: $1000 + 4 / -0$ hours
Humidity Resistance	Inductance change: Within $\pm 10\%$ Without distinct damage in appearance	1. Environment condition: $60 \pm 2$ °C Humidity: 90–95% Applied Current: Rated current 2. Duration: $1000 + 4 / -0$ hours
Low Temperature Store	Inductance change: Within $\pm 10\%$ Without distinct damage in appearance	Store temperature: $-55 \pm 2$ °C, $1000 + 4 / -0$ hours
High Temperature Store	Inductance change: Within $\pm 10\%$ Without distinct damage in appearance	Store temperature: $+125 \pm 2$ °C, $1000 + 4 / -0$ hours

## Tape Packaging Dimensions



A0	B0	K0	t
7.2±0.10	7.5±0.10	3.6±0.15	0.31±0.05

## Reel Dimensions

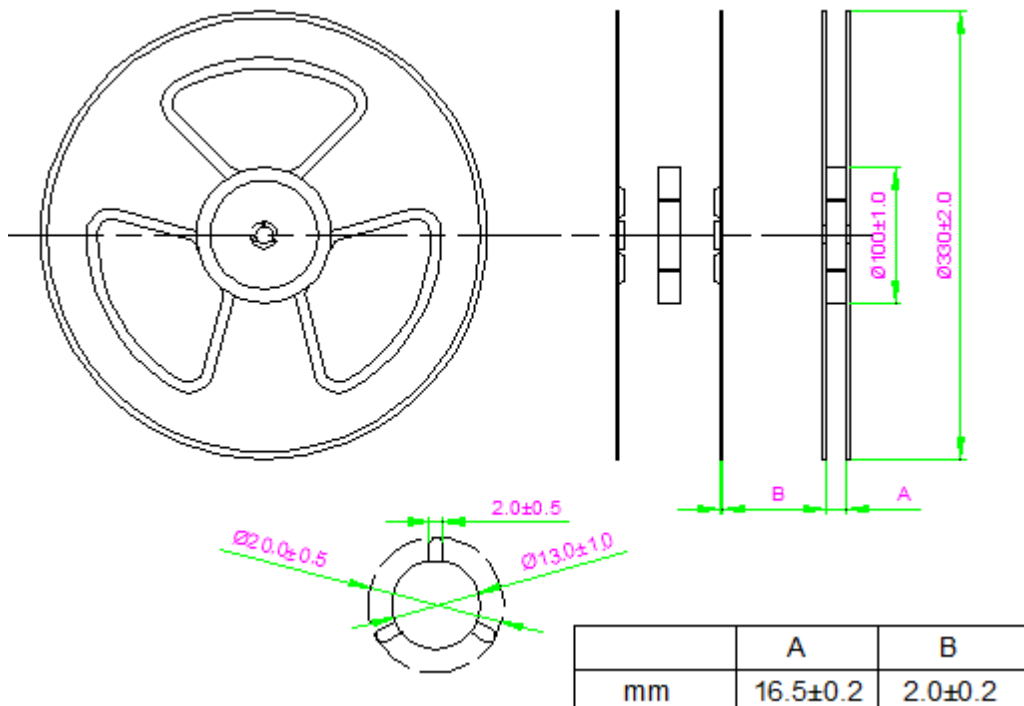

	A	B
mm	16.5±0.2	2.0±0.2

**Packaging Quantity:1000PCS/Reel**

## Recommended Soldering Technologies

### (1) Re-flowing Profile

Preheat condition: 150 ~200°C/60~180sec.

Allowed time above 217°C: 80~120sec.

Max temp: 260°C

Max time at max temp: 10 sec.

Solder paste: Sn/3.0Ag/0.5Cu

Allowed Reflow time: 2x max

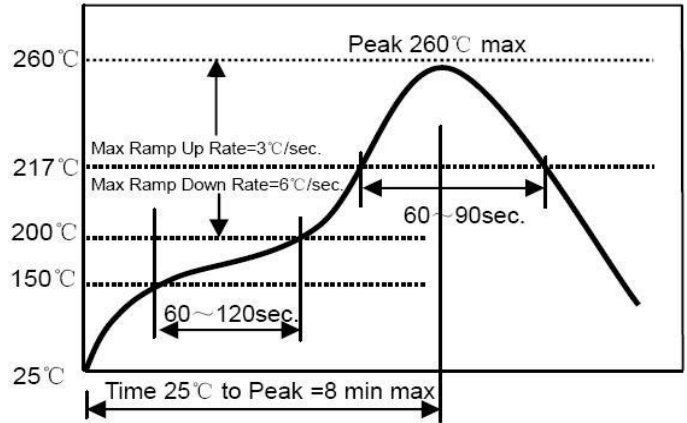

### (2) Iron Soldering Profile

Iron soldering power: Max.

30W Pre-heating: 150°C/60sec.

Soldering time: 3sec. Max.

Solder paste: Sn/3.0Ag/0.5Cu

Max.1 times for iron soldering

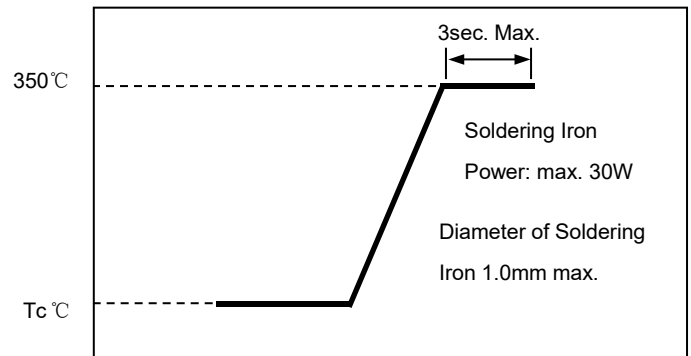



## X-ON Electronics

Largest Supplier of Electrical and Electronic Components

*Click to view similar products for [Fixed Inductors](#) category:*

*Click to view products by [MetalLions](#) manufacturer:*

Other Similar products are found below :

[CR32NP-100KC](#) [70F224AI](#) [MHQ1005P10NJ](#) [MHQ1005P1N0S](#) [MHQ1005P2N4S](#) [MHQ1005P3N6S](#) [MHQ1005P5N1S](#) [MHQ1005P8N2J](#)  
[PE-53601NL](#) [PE-53602NL](#) [PG0936.113NLT](#) [9220-20](#) [9310-16](#) [PM06-2N7](#) [PM06-39NJ](#) [A01TK](#) [1206CS-471XJ](#) [HC2-R47-R](#) [HC8-1R2-R](#)  
[HCF1305-3R3-R](#) [1206CS-151XG](#) [RCH664NP-4R7M](#) [RCP1317NP-391L](#) [DH2280-4R7M](#) [DS1608C-106](#) [B10TJ](#) [B82498B3101J000](#) [ELJ-](#)  
[RE27NJF2](#) [1812CS-153XJ](#) [1812CS-183XJ](#) [1812CS-223XJ](#) [1812LS-104XJ](#) [1812LS-105XJ](#) [1812LS-124XJ](#) [1812LS-154XJ](#) [1812LS-223XJ](#)  
[1812LS-224XJ](#) [1812LS-563XJ](#) [1812LS-683XJ](#) [1812LS-824XJ](#) [NIN-FB101JTR110F](#) [NIN-FB471JTR62F](#) [NIN-FC1R5JTR220F](#) [NIN-](#)  
[HCR15JTRF](#) [NIN-HCR33JTRF](#) [NIN-HDR22JTRF](#) [NIN-HDR82JTRF](#) [NIN-HK2N7STRF](#) [NIN-PA150KTR370F](#) [NIN-PB100KTR550F](#)