

## MCMB-1040 Series

### High Current Molded Power Inductors

#### FEATURES

- Powder iron core material
- Magnetically shielded, low EMI
- High current carrying capacity, Low core losses
- Frequency range up to 3 MHz
- Operate temperature range ....  $-40^{\circ}\text{C} \sim +125^{\circ}\text{C}$  (Including self temp. rise)
- RoHS compliant

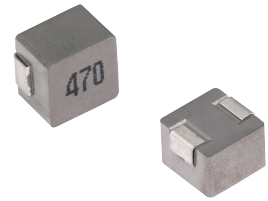

#### APPLICATIONS

- Voltage Regulator Module (VRM)
- Multi-phase regulators
- Point-of-load modules
- Smart phone POL modules
- SSD modules
- Notebook regulators
- Battery power systems
- Graphics cards
- Data networking and storage systems

#### Explanation of Part Number

MCMB -1040 -1R0 M T

1 2 3 4 5

- ◆ 1:Product Series:Metal Alloy Molding Power Inductor
- ◆ 2:Dimensions:
- ◆ 3: Initial inductance value: 1R0 = 1.0uH
- ◆ 4:Tolerance of Inductance:M:±20%
- ◆ 5:Packing:Tape Carrier Package

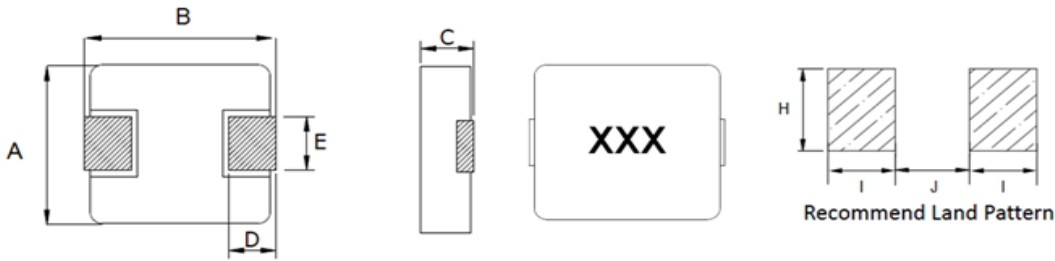
**Dimensions: [mm]**

Series	A	B	C	D	E	I Typ.	J Typ.	H Typ.
MCMB-1040	10.0±0.3	11.5Max	3.8±0.2	2.0±0.5	3.0±0.5	4.1	5.4	4.1

**Electrical Properties:**

Part Number	Inductance	DC Resistance	Saturation Current		Heat Rating Current	
	@100KHZ,1V	Max.	Max.	Typ.	Max.	Typ.
Units	μH	mΩ	A		A	
Symbol	L	DCR	Isat		Irms	
MCMB-1040-R13MT	0.13±20%	0.52 (±5%)	63.0	92.0	63.0	72.0
MCMB-1040-R15MT	0.15±20%	0.65	60.0	75.0	40.0	45.0
MCMB-1040-R22MT	0.22±20%	1	48.0	60.0	30.0	35.0
MCMB-1040-R30MT	0.30±20%	1.1	36.0	45.0	30.0	35.0
MCMB-1040-R36MT	0.36±20%	1.2	36.0	45.0	25.0	30.0
MCMB-1040-R45MT	0.45±20%	1.5	34.0	43.0	25.0	30.0
MCMB-1040-R47MT	0.47±20%	1.7	32.0	40.0	25.0	30.0
MCMB-1040-R56MT	0.56±20%	1.8	26.4	33.0	20.0	25.0
MCMB-1040-R68MT	0.68±20%	2.4	24.0	30.0	19.0	23.0
MCMB-1040-R80MT	0.80±20%	2.7	23.2	29.0	19.0	23.0
MCMB-1040-1R0MT	1.0±20%	3.3	22.4	28.0	16.0	19.0
MCMB-1040-1R5MT	1.5±20%	4.2	19.2	24.0	14.0	16.0
MCMB-1040-2R2MT	2.2±20%	7	13.2	16.5	10.0	12.0
MCMB-1040-3R3MT	3.3±20%	11.8	12.8	16.0	9.50	11.0
MCMB-1040-4R7MT	4.7±20%	20	10.4	13.0	7.50	9.00
MCMB-1040-6R8MT	6.8±20%	25	9.60	12.0	7.00	8.50
MCMB-1040-8R2MT	8.2±20%	27	7.20	9.00	6.80	8.00
MCMB-1040-100MT	10±20%	30	6.80	8.50	6.90	7.80
MCMB-1040-150MT	15±20%	45	5.60	7.00	5.60	6.50
MCMB-1040-220MT	22±20%	66	4.40	5.50	4.20	5.00
MCMB-1040-330MT	33±20%	92	3.84	4.80	3.80	4.40
MCMB-1040-470MT	47±20%	145	3.10	3.50	2.80	3.30
MCMB-1040-680MT	68±20%	195	2.40	3.00	2.00	2.50
MCMB-1040-820MT	82±20%	285	2.30	2.80	2.10	2.30
MCMB-1040-101MT	100±20%	340	2.10	2.30	1.80	2.00

### Notes

- ※1: All test data is referenced to 20°C ambient;
- ※2: Rated current: Isat or Irms, whichever is smaller;
- ※3: Isat(Typ): DC current at which the inductance drops approximate 30% from its value without current;
- ※4: Isat(Max): DC current at which the inductance drops approximate 20% from its value without current;
- ※5: Irms(Typ): DC current that causes the temperature rise ( $\Delta T = 40^\circ\text{C}$ ) from 20°C ambient.
- ※6: Irms(Max): DC current that causes the temperature rise ( $\Delta T = 20^\circ\text{C}$ ) from 20°C ambient.
- ※7: Absolute maximum voltage 30VDC

### Typical Performance Curve:

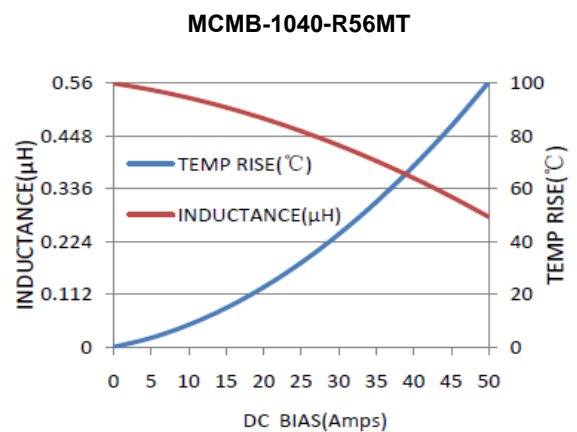
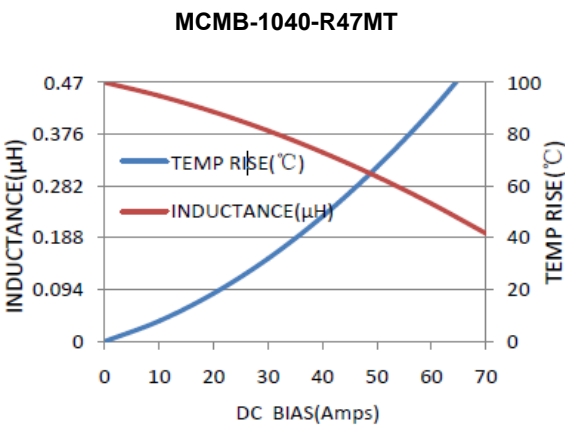
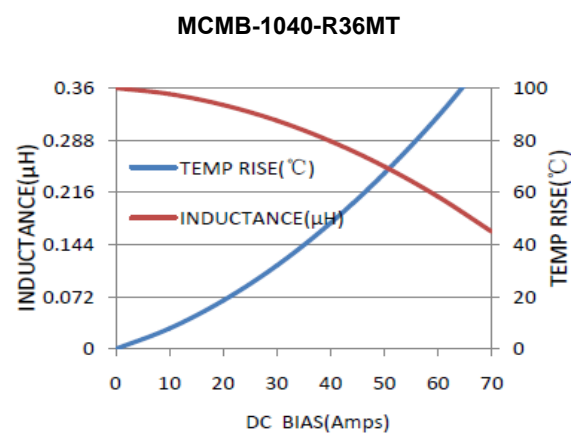
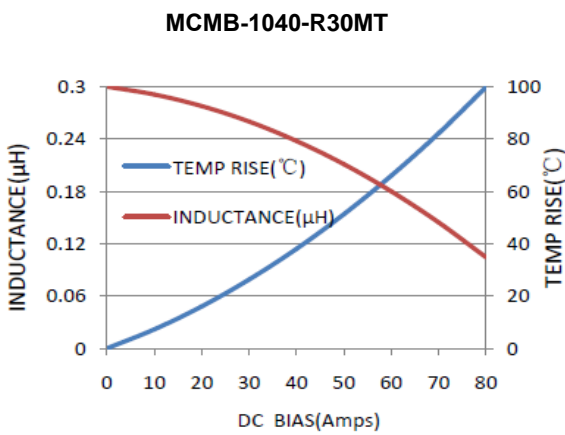
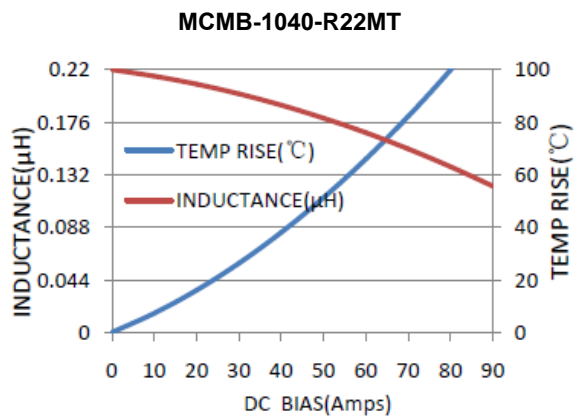
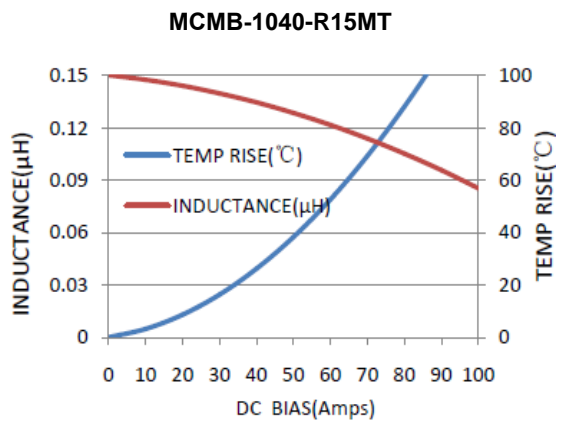

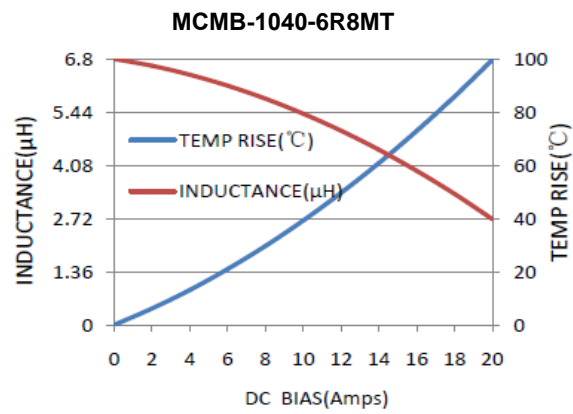
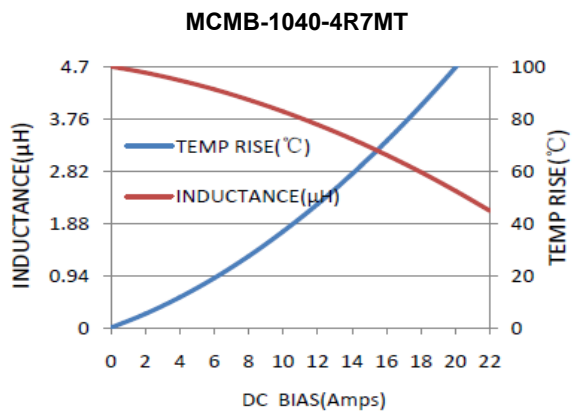
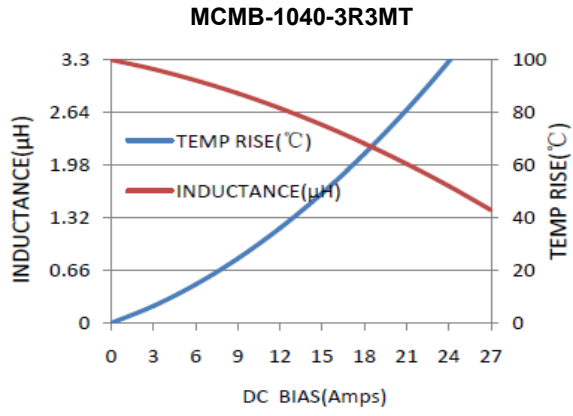
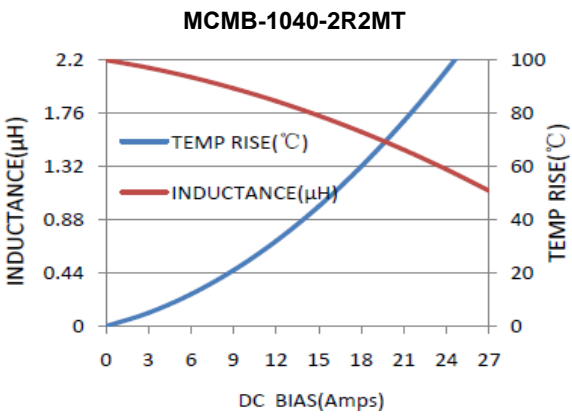
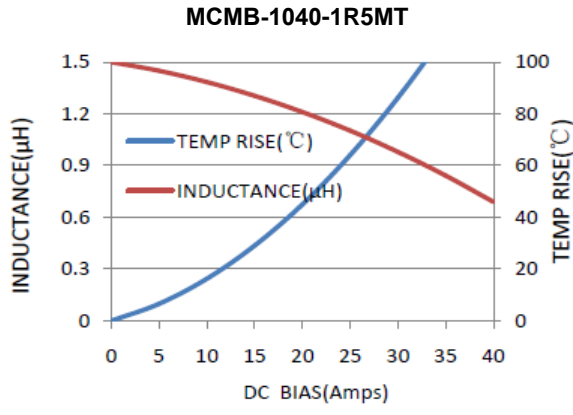
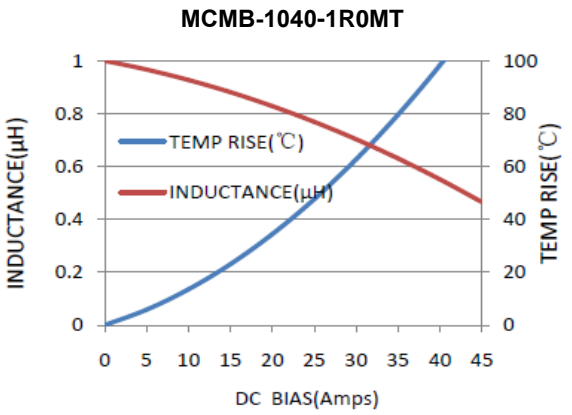
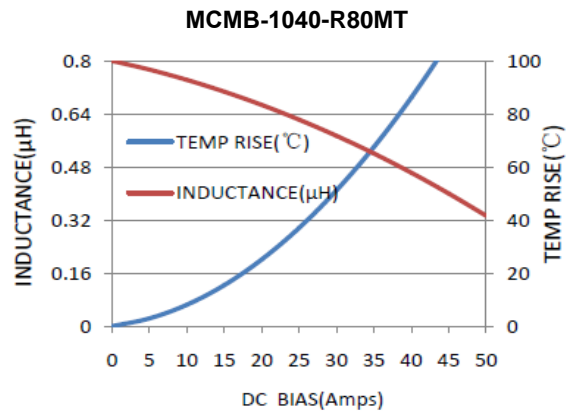
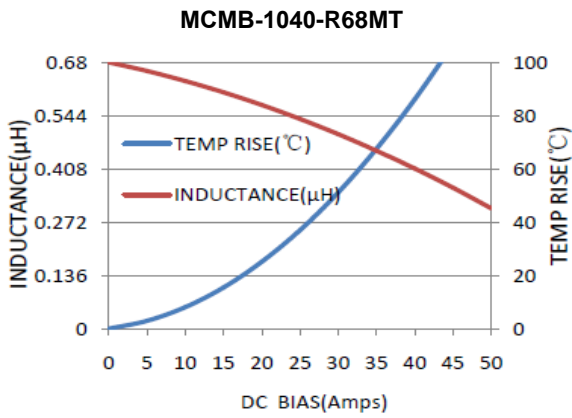

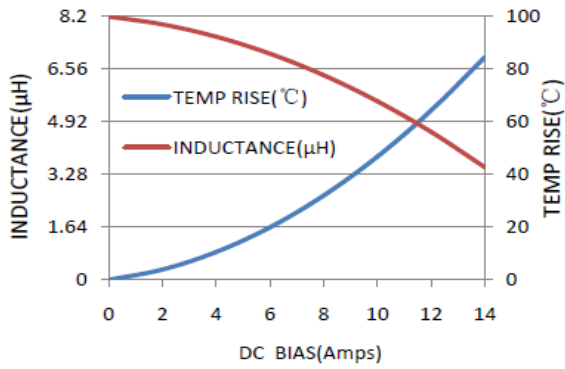
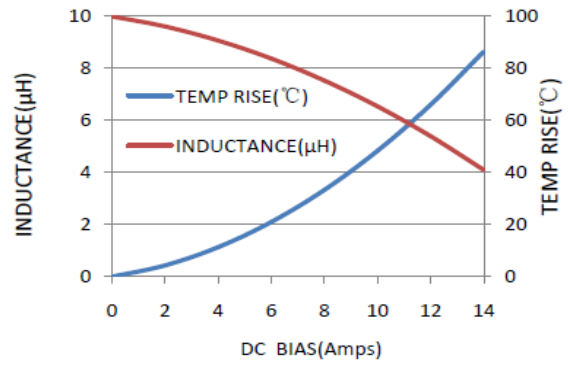
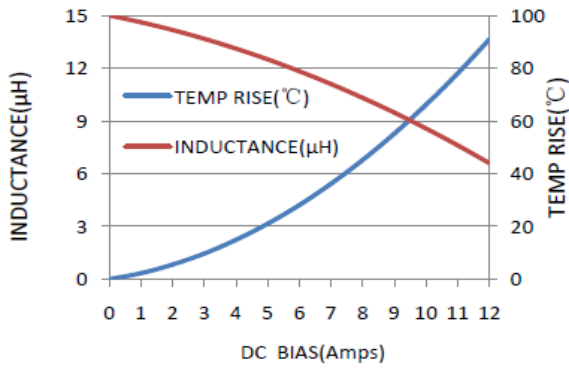
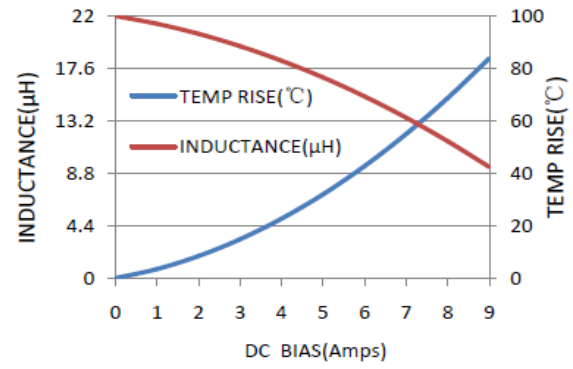
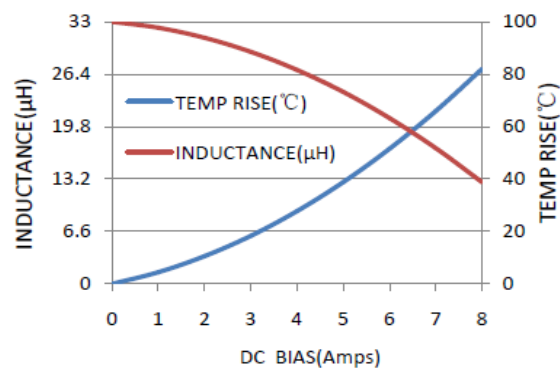
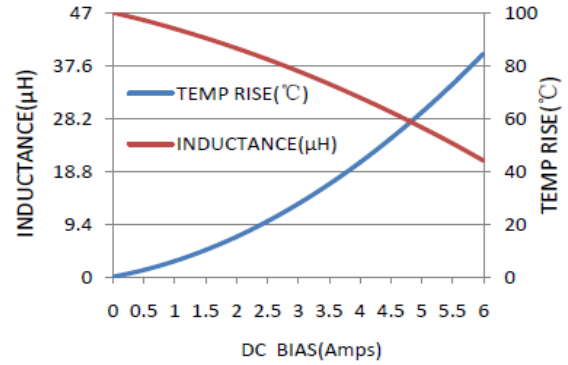
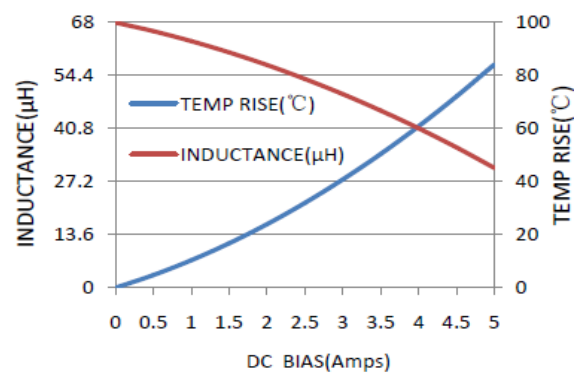
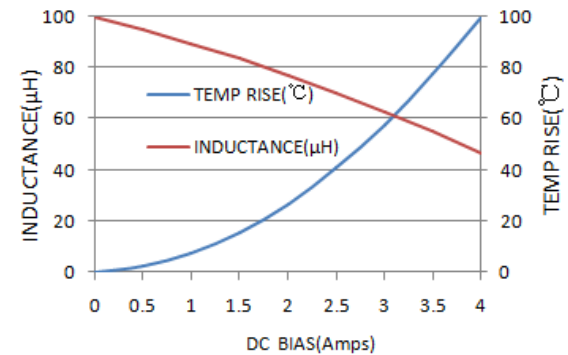
**MCMB-1040-8R2MT**

**MCMB-1040-100MT**

**MCMB-1040-150MT**

**MCMB-1040-220MT**

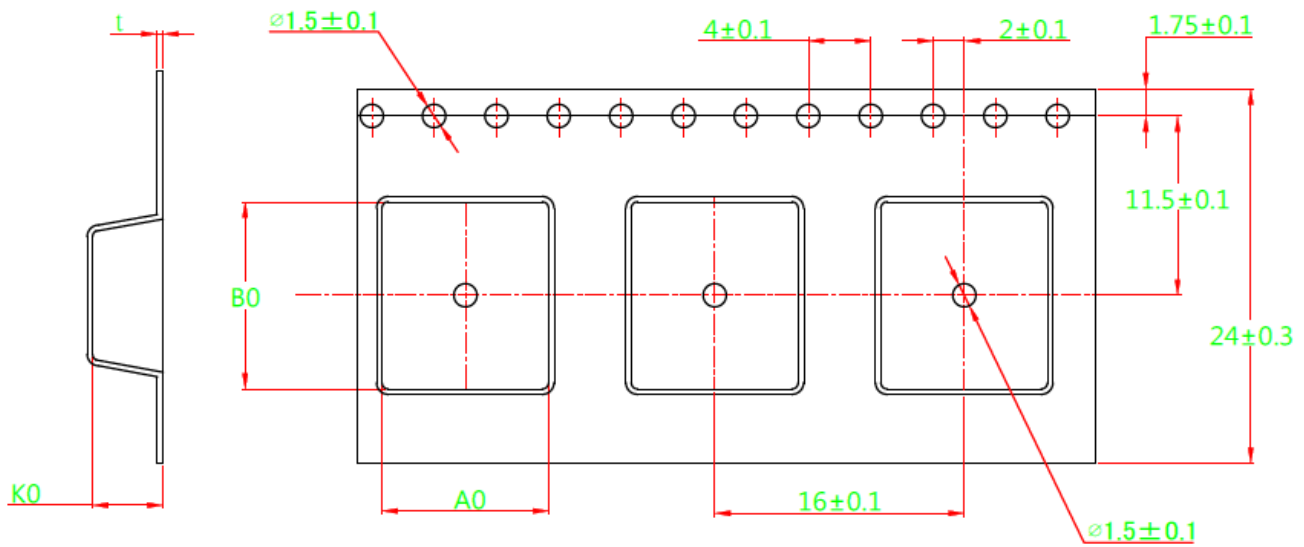
**MCMB-1040-330MT**

**MCMB-1040-470MT**

**MCMB-1040-680MT**

**MCMB-1040-101MT**

## Reliability and Test Condition

Mechanical Reliability		
Item	Specification and Requirement	Test Method
Solderability	The surface of terminal immersed shall be minimum of 95% covered with a new coating of solder	Solder heat proof: 1. Preheating: $160 \pm 10$ °C 2. Retention time: $245 \pm 5$ °C for $2 \pm 0.5$ seconds
Vibration	Inductance change: Within $\pm 10\%$ Without mechanical damage such as break	1. Vibration frequency: (10 Hz to 55 Hz to 10Hz) in 60 seconds as a period 2. Vibration time: Period cycled for 2 hours in each of 3 mutual perpendicular directions. 3. Amplitude: 1.5 mm max.
Shock	Inductance change: Within $\pm 10\%$ Without mechanical damage such as break	1. Peak value: 100 G 2. Duration of pulse: 11ms 3. 3 times in each positive and negative direction of 3 mutual perpendicular directions
Endurance Reliability		
Item	Specification and Requirement	Test Method
Thermal Shock	Inductance change: Within $\pm 10\%$ Without distinct damage in appearance	1. Repeat 100 cycles as follow: ( $-55 \pm 2$ °C; $30 \pm 3$ min) →(Room temp., 5 min) → ( $+125 \pm 2$ °C, $30 \pm 3$ min) → (Room temp., 5 min) 2. Recovery: $48 + 4 / -0$ hours of recovery under the standard condition after the test.
High Temperature Resistance	Inductance change: Within $\pm 10\%$ Without distinct damage in appearance	1. Environment condition: $85 \pm 2$ °C Applied Current: Rated current 2. Duration: $1000 + 4 / -0$ hours
Humidity Resistance	Inductance change: Within $\pm 10\%$ Without distinct damage in appearance	1. Environment condition: $60 \pm 2$ °C Humidity: 90–95% Applied Current: Rated current 2. Duration: $1000 + 4 / -0$ hours
Low Temperature Store	Inductance change: Within $\pm 10\%$ Without distinct damage in appearance	Store temperature: $-55 \pm 2$ °C, $1000 + 4 / -0$ hours
High Temperature Store	Inductance change: Within $\pm 10\%$ Without distinct damage in appearance	Store temperature: $+125 \pm 2$ °C, $1000 + 4 / -0$ hours

## Tape Packaging Dimensions



A0	B0	K0	t
$10.7 \pm 0.10$	$12.0 \pm 0.10$	$4.5 \pm 0.1$	$0.35 \pm 0.025$

## Reel Dimensions

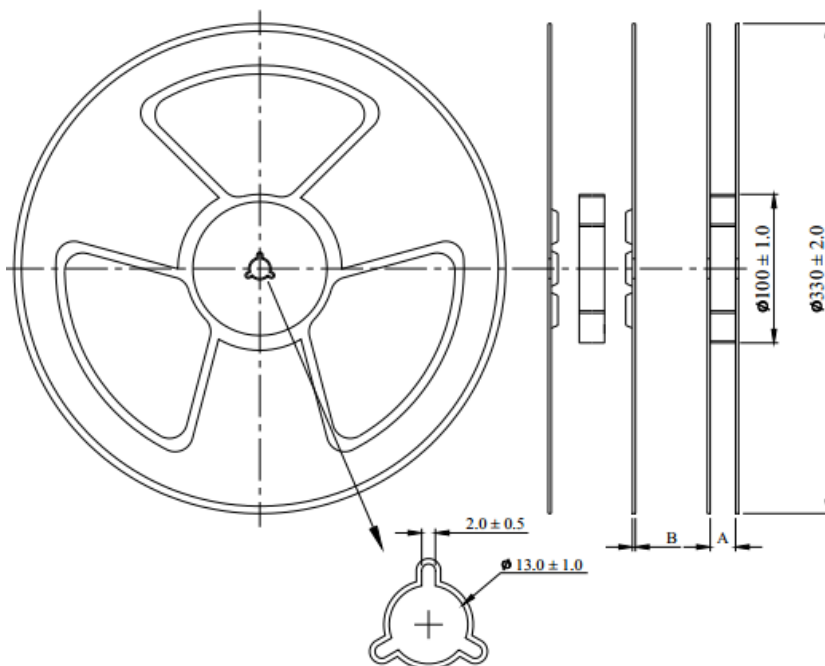

	A	B
mm	$24.5 \pm 0.2$	$2.0 \pm 0.2$

**Packaging Quantity:500PCS/Reel**

## Recommended Soldering Technologies

### (1) Re-flowing Profile

Preheat condition: 150 ~200°C/60~180sec.

Allowed time above 217°C: 80~120sec.

Max temp: 260°C

Max time at max temp: 10 sec.

Solder paste: Sn/3.0Ag/0.5Cu

Allowed Reflow time: 2x max

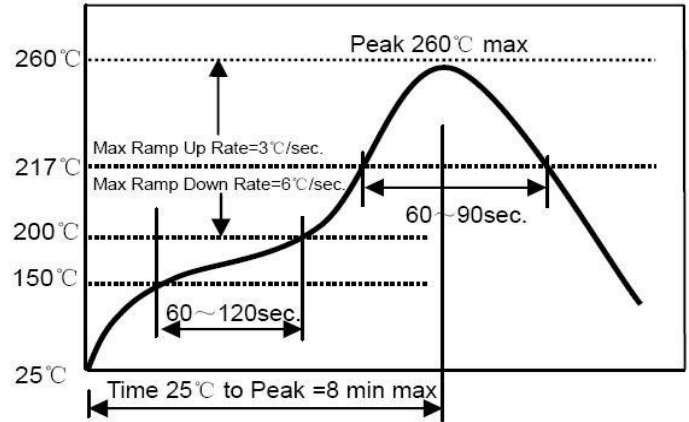

### (2) Iron Soldering Profile

Iron soldering power: Max.

30W Pre-heating: 150°C/60sec.

Soldering time: 3sec. Max.

Solder paste: Sn/3.0Ag/0.5Cu

Max.1 times for iron soldering

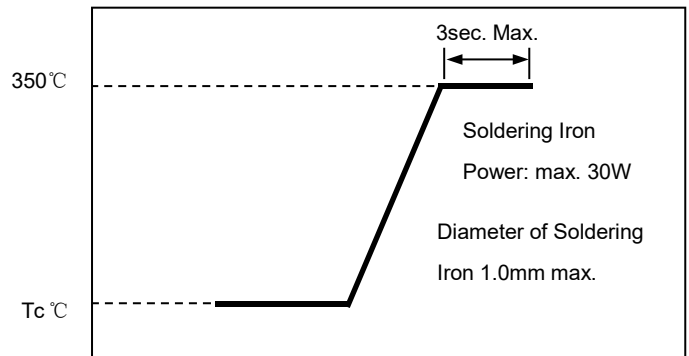



## X-ON Electronics

Largest Supplier of Electrical and Electronic Components

*Click to view similar products for [Fixed Inductors](#) category:*

*Click to view products by [MetalLions](#) manufacturer:*

Other Similar products are found below :

[CR32NP-100KC](#) [70F224AI](#) [MHQ1005P10NJ](#) [MHQ1005P1N0S](#) [MHQ1005P2N4S](#) [MHQ1005P3N6S](#) [MHQ1005P5N1S](#) [MHQ1005P8N2J](#)  
[PE-53601NL](#) [PE-53602NL](#) [PG0936.113NLT](#) [9220-20](#) [9310-16](#) [PM06-2N7](#) [PM06-39NJ](#) [A01TK](#) [1206CS-471XJ](#) [HC2-R47-R](#) [HC8-1R2-R](#)  
[HCF1305-3R3-R](#) [1206CS-151XG](#) [RCH664NP-4R7M](#) [RCP1317NP-391L](#) [DH2280-4R7M](#) [DS1608C-106](#) [B10TJ](#) [B82498B3101J000](#) [ELJ-](#)  
[RE27NJF2](#) [1812CS-153XJ](#) [1812CS-183XJ](#) [1812CS-223XJ](#) [1812LS-104XJ](#) [1812LS-105XJ](#) [1812LS-124XJ](#) [1812LS-154XJ](#) [1812LS-223XJ](#)  
[1812LS-224XJ](#) [1812LS-563XJ](#) [1812LS-683XJ](#) [1812LS-824XJ](#) [NIN-FB101JTR110F](#) [NIN-FB471JTR62F](#) [NIN-FC1R5JTR220F](#) [NIN-](#)  
[HCR15JTRF](#) [NIN-HCR33JTRF](#) [NIN-HDR22JTRF](#) [NIN-HDR82JTRF](#) [NIN-HK2N7STRF](#) [NIN-PA150KTR370F](#) [NIN-PB100KTR550F](#)