

MNR6045S Series

Wire Wound SMD Power Inductors

FEATURES

- Magnetic-resin shielded construction reduces buzz noise to ultra-low levels
- Metallization on ferrite core results in excellent shock resistance and damage-free durability
- Closed magnetic circuit design reduces leakage flux and Electro Magnetic Interference (EMI)
- 30% higher current rating than conventional inductors of equal size
- Takes up less PCB real estate and save more power
- Operate temperature range $-40^{\circ}\text{C} \sim +125^{\circ}\text{C}$ (Including self temp. rise)
- RoHS compliant



APPLICATIONS

- Smart phone, smart TV, set top box, notebook
- Car navigation systems, telecomm base stations
- VR, AR
- LED lighting

Explanation of Part Number

MNR 6045 S 1R0 M T

1 2 3 4 5 6

- ◆ 1:Product Series:Wire Wound SMD Power Inductors
- ◆ 2:Dimensions:
- ◆ 3: Feature Type:S Type
- ◆ 4: Initial inductance value: 1R0 = 1.0uH
- ◆ 5: Tolerance of Inductance:M: $\pm 20\%$, N: $\pm 30\%$
- ◆ 6:Packing:Tape Carrier Package

Dimensions: [mm]

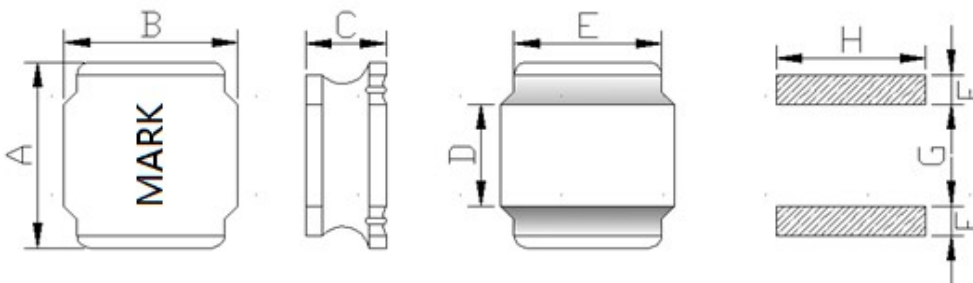

A	6.00±0.3
B	6.00±0.3
C	4.5 Max
D	2.9±0.3
E	4.9 Ref
F	1.7 Ref
G	2.8 Ref
H	5.7 Ref

Electrical Characteristics List

Part NO.	Inductance(μ H)	Test Freq. (kHz/v)	DC Max (Ω)	Isat (A)Max	Irms (A)Max
MNR6045S252MT	2500 \pm 20%	100/1	15.47	0.19	0.14

※1: All test data is referenced to 20°C ambient;

※2: Rated current: Isat or Irms, whichever is smaller;

※*3: Isat: DC current at which the inductance drops approximate 30% from its value without current;

※*4: Irms: DC current that causes the temperature rise ($\Delta T = 40^\circ\text{C}$) from 20°C ambient.

Structure (The structure of product.)

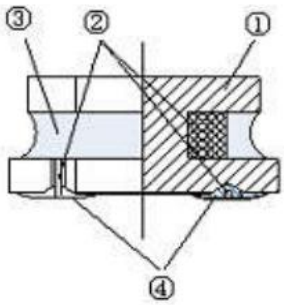

NO	Components	Material
①	Core	Ni-Zn Ferrite
②	Wire	Polyurethane system enameled copper wire
③	Magnetic Glue	Epoxy resin and magnetic powder
④	Plating	AgNiSn or FeNiCu + Sn Alloy

Reliability Test

TEST ITEM	SPECIFICATION	TEST CONDITION
Withstanding voltage test	After test, inductors shall have no evidence of electrical and mechanical damage.	AC voltage of 100v and AC current of 1mA applied between inductor's terminal and core for 3 secs.
Resistance to soldering heat	<ol style="list-style-type: none"> 1. Inductor shall have no evidence of electrical and mechanical damage. 2. Inductance shall not change more than $\pm 5\%$. 3. Q shall not change more than 20%. 	<ol style="list-style-type: none"> a. Temp: 260 ± 5 b. Time: 10 ± 1.0 se
Solderability test	The terminal shall be at least 95% covered with solder.	After fluxing, the terminal shall be dipped in a melted solder bath at $245 \pm 5^\circ\text{C}$ for 4 ± 1.0 secs.
High temperature & high humidity test	The anti-erosion quality of the surface and the specimen's inductance shall not change from the initial value within $\pm 10\%$	<ol style="list-style-type: none"> a. Test condition <ol style="list-style-type: none"> 1)Temp.: 85°C, R.H.:85% 2)Time: 144 ± 2 hours b. Measurement method The experimental component should be put at normal condition for 2 hours then to measure again after test
Salt spray test		<ol style="list-style-type: none"> a. Test condition <ol style="list-style-type: none"> 1)Temp.: $35 \pm 2^\circ\text{C}$ 2)Time: 48 ± 2 hours 3)Salt solution PH: 6.5~7.2 b. Measurement method The experimental component should be put at normal condition for 2 hours then to measure again after test
Vibration test	<ol style="list-style-type: none"> 1. Inductance shall be within 10% of the initial value. 2. Appearance: no damage 	<ol style="list-style-type: none"> a. Frequency: 10 to 55 b. Amplitude: 1.5 c. Direction and time X, Y and Z directions for 2 hours each.

TEST ITEM	SPECIFICATION	TEST CONDITION
Free fall test	No mechanical damage shall be noticed.	Drop 5 times on a concrete floor from 1m the height
Temperature Cycling test	1. Inductance shall be within 10% of the initial value 2. Appearance: No dama	a. Test conditi 1)Temp.: -55°C ,time: $30\pm 3\text{min}$ 2)Temp.: $+125^{\circ}\text{C}$,time: $30\pm 3\text{min}$ 3)Cycles times:12 cycles b. Measurement method The experimental component should be put at normal condition for 2 hours then to measure again after test
High Temperature resistance test		a. Test conditi 1)Applied rated current 2)Temp.: $85^{\circ}\text{C}\pm 2^{\circ}\text{C}$ 3)Test time:1000+24/-0H b. Measurement method The experimental component should be put at normal condition for 24 hours then to measure again after test.
Low temperature resistance test		a. Test conditi 1)Temp.: $-55^{\circ}\text{C}\pm 2^{\circ}\text{C}$ 2)Test time:1000+24/-0H b. Measurement method The experimental component should be put at normal condition for 24 hours then to measure again after test.

We have suggested the storage period of lead-free product should not over 6 months.

Packaging

1) Tape packing diagram

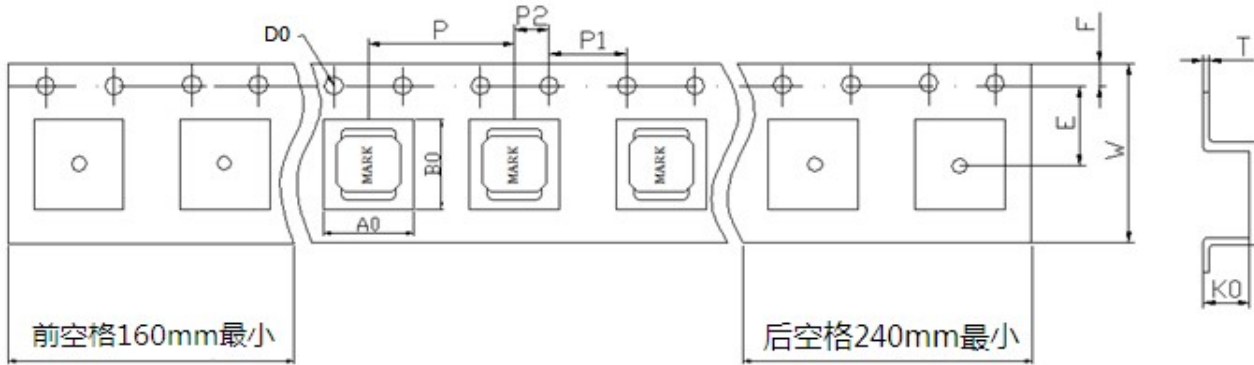

ITEM	W	A0	B0	K0	P	E	F	D0	P0	P2	T
DIM	12.00	6.30	6.30	4.70	8.00	5.50	1.75	1.50	4.00	2.00	0.35
TOLE	±0.3	±0.1	±0.1	±0.1	±0.1	±0.1	±0.1	+0.1	±0.1	±0.1	±0.05

2) Tape packing diagram

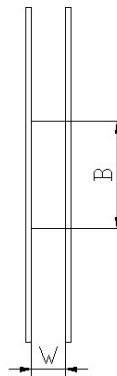
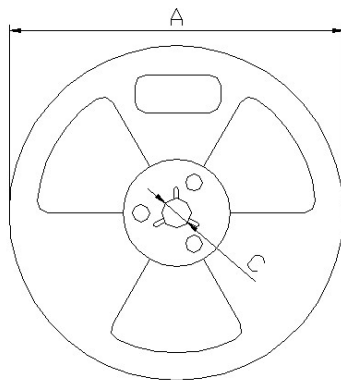

A	330±0.5
B	100±0.5
C	13.5±0.5
W	12.5±0.5

3) Tape packing diagram

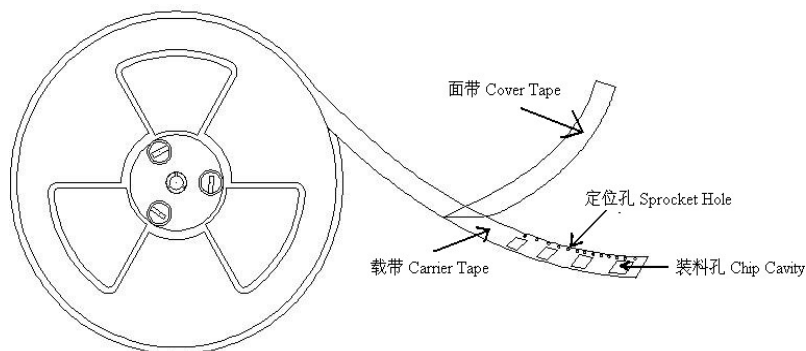

Packaging Quantity: 1500pcs/Reel

SOLDERING CONDITIONS

1. Reflow Soldering Profile

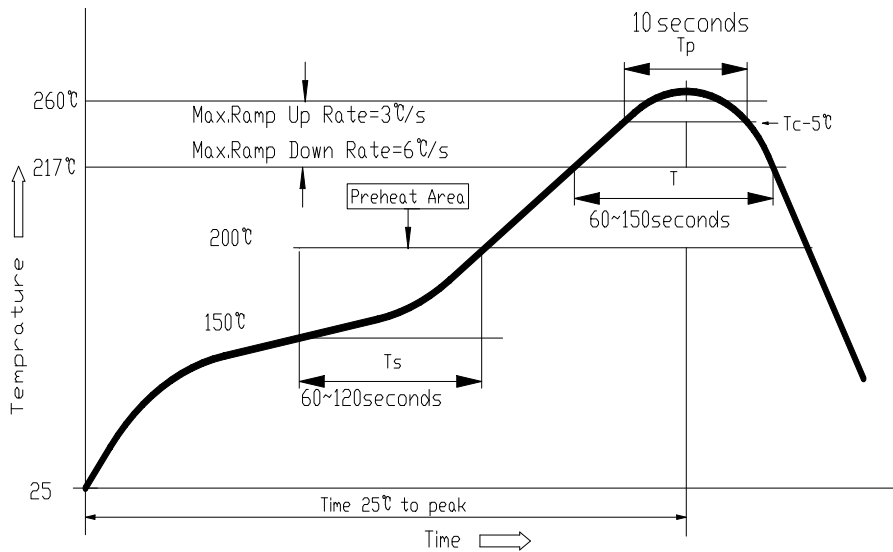

2. Soldering Iron

Reworking with electric soldering iron must preheating at 150°C for 1 minute is required, and do not directly touch the core with the tip of the soldering iron. The reworking soldering conditions are as follows.

- ① Temperature of soldering iron tip: 350°C;
- ② Soldering iron power output: ≤30W;
- ③ Diameter of soldering iron end: ≤1.0mm;
- ④ Soldering time: <3 s



X-ON Electronics

Largest Supplier of Electrical and Electronic Components

Click to view similar products for [Fixed Inductors](#) category:

Click to view products by [MetalLions](#) manufacturer:

Other Similar products are found below :

[CR32NP-100KC](#) [70F224AI](#) [MHQ1005P10NJ](#) [MHQ1005P1N0S](#) [MHQ1005P2N4S](#) [MHQ1005P3N6S](#) [MHQ1005P5N1S](#) [MHQ1005P8N2J](#)
[PE-53601NL](#) [PE-53602NL](#) [PG0936.113NLT](#) [9220-20](#) [9310-16](#) [PM06-2N7](#) [PM06-39NJ](#) [A01TK](#) [1206CS-471XJ](#) [HC2-R47-R](#) [HC8-1R2-R](#)
[HCF1305-3R3-R](#) [1206CS-151XG](#) [RCH664NP-4R7M](#) [RCP1317NP-391L](#) [DH2280-4R7M](#) [DS1608C-106](#) [B10TJ](#) [B82498B3101J000](#) [ELJ-](#)
[RE27NJF2](#) [1812CS-153XJ](#) [1812CS-183XJ](#) [1812CS-223XJ](#) [1812LS-104XJ](#) [1812LS-105XJ](#) [1812LS-124XJ](#) [1812LS-154XJ](#) [1812LS-223XJ](#)
[1812LS-224XJ](#) [1812LS-563XJ](#) [1812LS-683XJ](#) [1812LS-824XJ](#) [NIN-FB101JTR110F](#) [NIN-FB471JTR62F](#) [NIN-FC1R5JTR220F](#) [NIN-](#)
[HCR15JTRF](#) [NIN-HCR33JTRF](#) [NIN-HDR22JTRF](#) [NIN-HDR82JTRF](#) [NIN-HK2N7STRF](#) [NIN-PA150KTR370F](#) [NIN-PB100KTR550F](#)