

## MTQH2012 Series

### Mini Molded Chip Power Inductors

#### FEATURES

- Metal material for large current and low loss
- Vinyl thermal spray, better surface compactness
- Closed magnetic circuit design reduces leakage flux
- Operate temperature range ....  $-55^{\circ}\text{C} \sim +125^{\circ}\text{C}$  (Including self temp. rise)
- RoHS compliant



#### APPLICATIONS

- Smart phone, pad
- Notebooks, VR, AR
- Portable gaming devices, Smart wear, Wi-Fi module

#### Explanation of Part Number

MTQH 201210 S 2R2 M B T A  
 1 2 3 4 5 6 7 8

- ◆ 1:Series Name:Mini Molding Chip type power inductor
- ◆ 2:Size Code: L\*W\*T
- ◆ 3: Material Code:S,B Type
- ◆ 4:Initial inductance value: 2R2 = 2.2uH
- ◆ 5:Tolerance of Inductance:M: $\pm 20\%$
- ◆ 6:Coating color:B=Black
- ◆ 7:Packing:Tape Carrier Package
- ◆ 8:Internal Code: A,B

#### Dimensions: [mm]

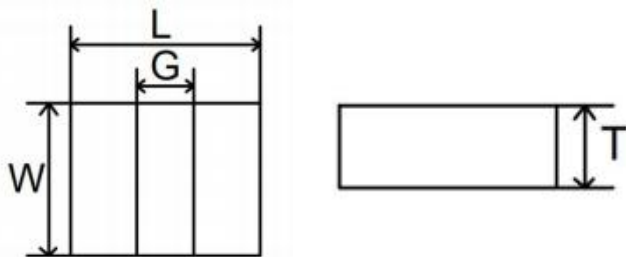

#### Land Pattern: [mm]

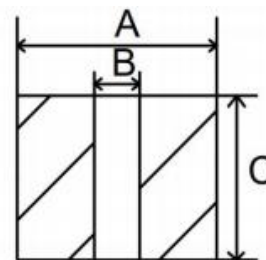

Series	L	G	W	T	A	B	C
MTQH201265S	$2.0 \pm 0.2$	$0.5 \pm 0.2$	$1.2 \pm 0.2$	0.65Max.	2.10	0.50	1.30
MTQH201208S	$2.0 \pm 0.2$	$0.5 \pm 0.2$	$1.2 \pm 0.2$	0.80Max.	2.10	0.50	1.30
MTQH201210S	$2.0 \pm 0.2$	$0.5 \pm 0.2$	$1.2 \pm 0.2$	1.00Max.	2.10	0.50	1.30

## Electrical Properties:

MTQH201265(2.0\*1.2\*0.65mm)

P/N	L0( $\mu$ H) @ (0A) 1MHz	Rdc(m $\Omega$ )		Heat rating current Irms(A)		Saturation current Isat(A)	
		Typical	Max	Typical	Max	Typical	Max
MTQH201265S1R0MBT	1.0	78	86	2.6	2.3	2.8	2.5
MTQH201265B1R0MBT	1.0	95	110	2.5	2.2	2.7	2.4
MTQH201265S2R2MBT	2.2	215	230	1.7	1.4	1.8	1.5

MTQH201208(2.0\*1.2\*0.8mm)

P/N	L0( $\mu$ H) @ (0A) 1MHz	Rdc(m $\Omega$ )		Heat rating current Irms(A)		Saturation current Isat(A)	
		Typical	Max	Typical	Max	Typical	Max
MTQH201208SR24MBT	0.24	18	23	6.5	5.9	6.5	6.0
MTQH201208SR24MBTB	0.24	17	20	6.0	5.5	7.0	6.6
MTQH201208SR33MBT	0.33	33	45	4.3	4.0	5.2	4.8
MTQH201208SR47MBT	0.47	34	50	3.5	3.3	5.0	4.6
MTQH201208SR47MBTA	0.47	24	28	4.7	4.5	5.2	4.8
MTQH201208DR47MBT	0.47	34	42	4.3	3.9	5.2	4.8
MTQH201208SR68MBT	0.68	50	60	3.7	3.3	4.2	3.7
MTQH201208S1R0MBT	1.0	55	70	3.3	2.9	4.0	3.5
MTQH201208S1R0MBTA	1.0	48	55	3.2	2.8	3.2	2.8
MTQH201208S1R5MBT	1.5	118	135	2.2	1.9	3.0	2.5
MTQH201208S2R2MBT	2.2	160	185	2.2	1.8	2.6	2.3
MTQH201208S3R3MBT	3.3	253	300	1.8	1.5	1.9	1.6
MTQH201208S4R7MBT	4.7	285	325	1.7	1.5	1.6	1.4

MTQH201210(2.0\*1.2\*1.0mm)

P/N	L0( $\mu$ H) @ (0A) 1MHz	Rdc(m $\Omega$ )		Heat rating current Irms(A)		Saturation current Isat(A)	
		Typical	Max	Typical	Max	Typical	Max
MTQH201210SR10MBT	0.1	8.0	13	7.5	7.0	8.5	8.0
MTQH201210SR22MBT	0.22	16	22	7.1	6.5	7.3	6.8
MTQH201210SR24MBT	0.24	17	23	7.0	6.4	7.2	6.7
MTQH201210SR24MBTA	0.24	13	17	7.0	6.4	7.2	6.7
MTQH201210SR33MBT	0.33	24	32	5.5	5.0	6.5	6.0
MTQH201210SR33MBTB	0.33	18	22	5.7	5.2	6.7	6.3
MTQH201210SR47MBT	0.47	29	36	4.7	4.3	5.5	5.0
MTQH201210SR47MBTB	0.47	22	26	5.0	4.5	6.0	5.5
MTQH201210SR68MBT	0.68	37	43	4.3	4.0	5.0	4.5
MTQH201210S1R0MBT	1.0	55	63	3.9	3.5	4.0	3.5
MTQH201210S1R5MBT	1.5	76	85	3.1	2.6	3.2	2.7
MTQH201210S2R2MBT	2.2	135	150	2.0	1.7	2.7	2.4
MTQH201210S6R8MBT	6.8	440	520	1.5	1.3	1.45	1.2
MTQH201210S100MBT	10.0	600	660	1.1	1.0	1.2	1.0

#### Test remarks

Note 1.: All test data is referenced to 25 °C ambient.

Note 2.: Test Condition:1MHz, 1.0Vrms.

Note 3.: Irms:DC current (A) that will cause an approximate  $\Delta$ T of 40 °C.

Note 4.: Isat:DC current (A) that will cause L0 to drop approximately 30%.

Note 5.: Operating Temperature Range -55°C to + 125°C.

Note 6.: The part temperature (ambient + temp rise) should not exceed 125 under °C the worst case operating conditions. Circuit design, component placement, PCB trace size and thickness, airflow and other cooling provision all affect the part temperature. Part temperature should be verified in the end application.

Note 7.: The rated current as listed is either the saturation current or the heating current depending on which value is lower.

#### Structure

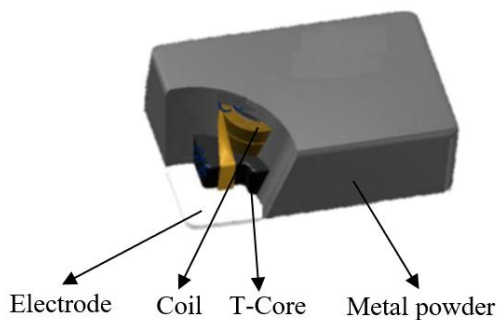

## Current Characteristic

MTQH201265S1R0MBT

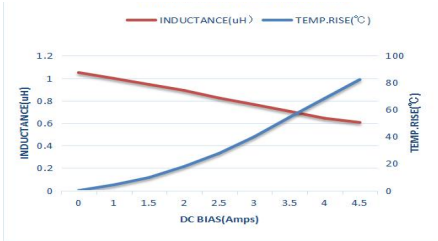

MTQH201265D1R0MBT

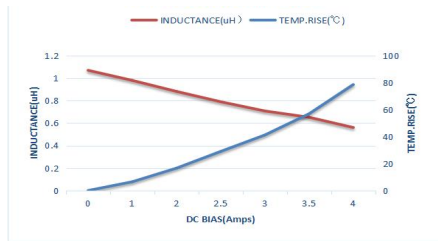

MTQH201265S2R2MBT

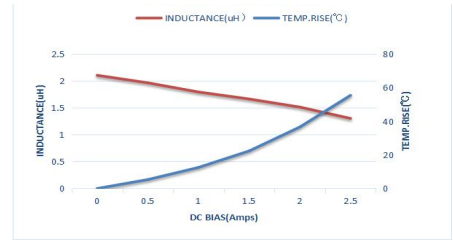

MTQH201208SR24MBT

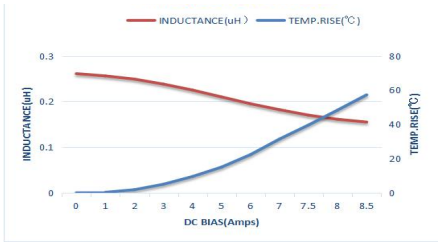

MTQH201208SR33MBT

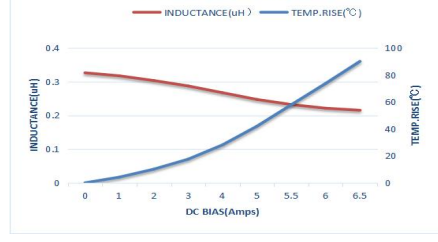

MTQH201208SR47MBT

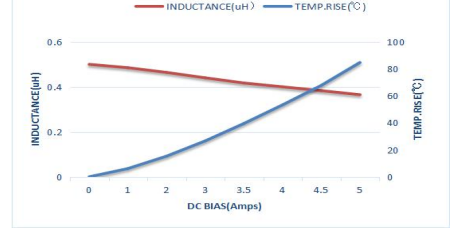

MTQH201208SR47MBTA

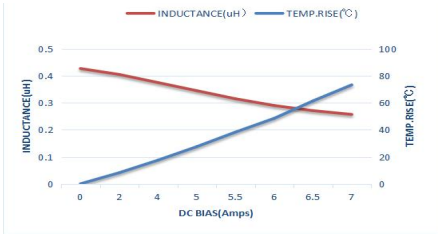

MTQH201208SR68MBT

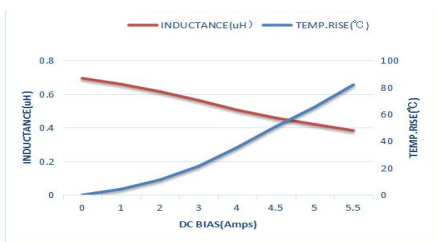

MTQH201208S1R0MBT

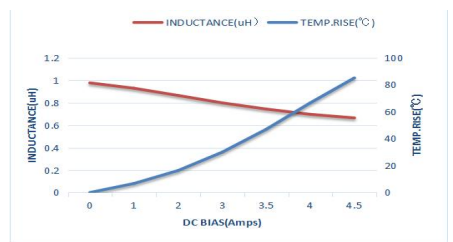

MTQH201208S1R0MBTA

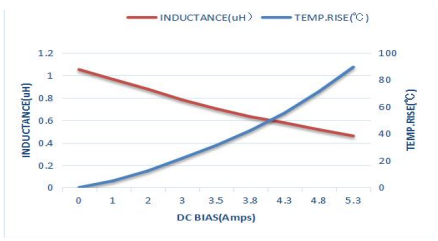

MTQH201208S1R5MBT

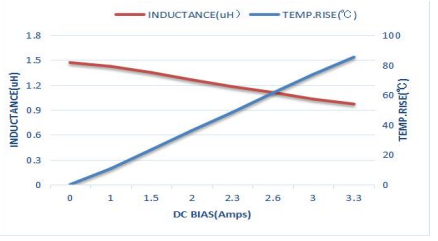

MTQH201208S2R2MBT

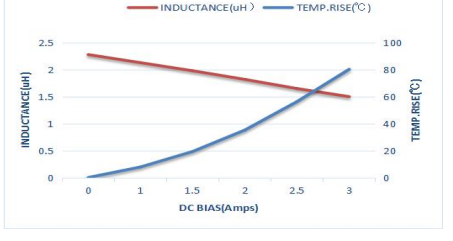

MTQH201208S3R3MBT

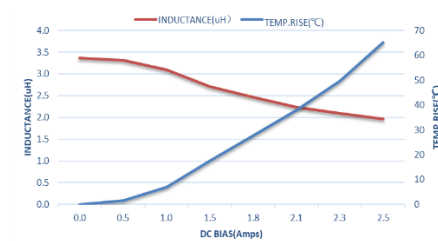

MTQH201208S4R7MBT

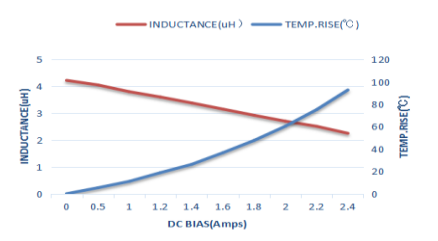

MTQH201210SR10MBT

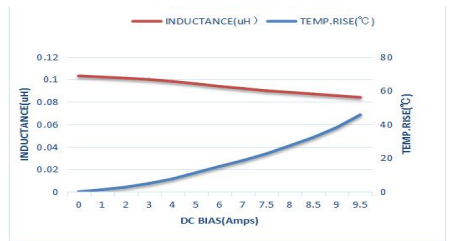

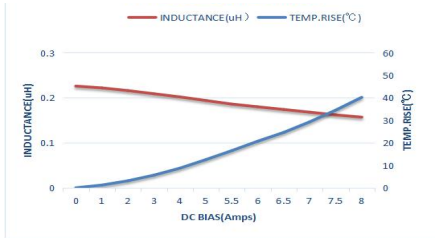
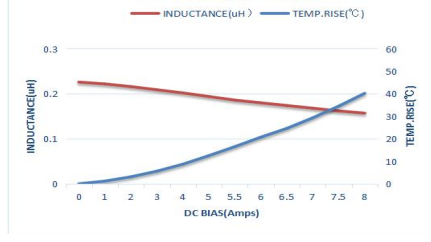
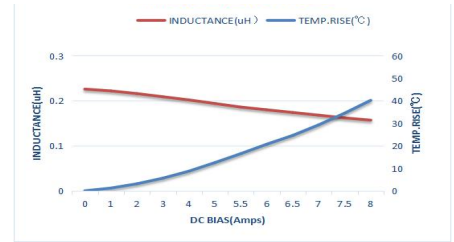
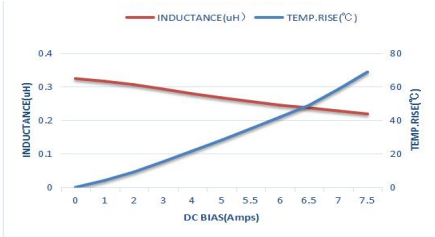
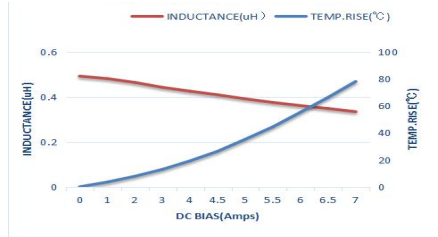
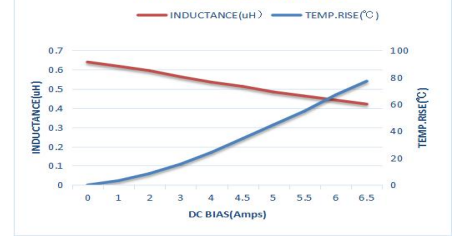
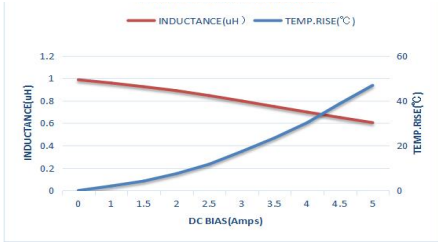
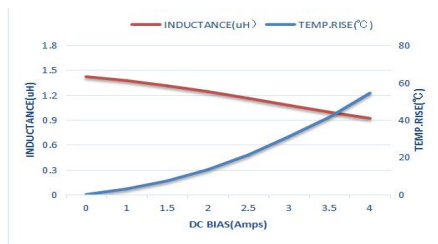
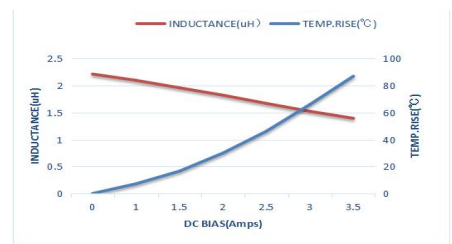
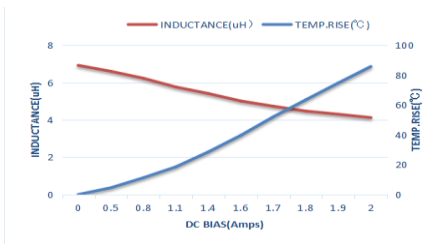
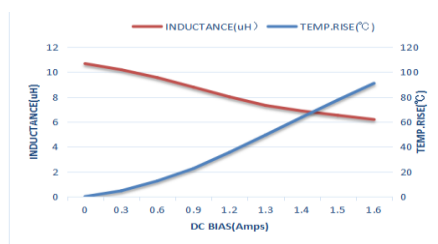
**MTQH201210SR22MBT**

**MTQH201210SR24MBT**

**MTQH201210SR24MBTA**

**MTQH201210SR33MBT**

**MTQH201210SR47MBT**

**MTQH201210SR68MBT**

**MTQH201210S1R0MBT**

**MTQH201210S1R5MBT**

**MTQH201210S2R2MBT**

**MTQH201210S6R8MBT**

**MTQH201210S100MBT**

## Reliability

Item	Requirements	Test Methods and Remarks
Insulation Resistance	$\geq 100M\Omega$	100 VDC between inductor coil and The middle of the top surface of the body for 60 seconds.
Solderability	90% or more of electrode area shall be coated by new solde.	Dip pads in flux . Solder Composition: Sn/Ag3.0/Cu0.5(Pb-Free). Solder Temperature: $245 \pm 5^{\circ}C$ . Immersion Time: $(5 \pm 1)$ s.
Resistance to Soldering Heat	No visible mechanical damage. Inductance change: Within $\pm 10$ .	Dip pads in flux. Solder Composition: Sn/Ag3.0/Cu0.5(Pb-Free). Solder Temperature: $260 \pm 5^{\circ}C$ . Immersion Time: $10 \pm 1$ sec.
Adhesion of teral electrode	Strong bond between the pad and the core, without come off PCB.	Inductors shall be subjected to $(260 \pm 5)^{\circ}C$ for $(20 \pm 5)$ s Soldering in the base whit 0.3mm solder. And then aplombelectrode way plus tax 10 N for $(10 \pm 1)$ seconds.
High temperature	No case deformation or change in appearance. Inductance change: Within $\pm 10\%$	Temperature: $125 \pm 2^{\circ}C$ . Time : 1000 hours. Measurement at $24 \pm 4$ hours after test conclusion.
Low temperature	No visible mechanical damage. Inductance change: Within $\pm 10\%$	Temperature: $-40 \pm 2^{\circ}C$ . Time : 1000 hours. Measurement at $24 \pm 4$ hours after test conclusion.
Thermal shock	No visible mechanical damage. Inductance change: Within $\pm 10\%$	The test sample shall be placed at $(-55 \pm 3)^{\circ}C$ and $(125 \pm 3)^{\circ}C$ for $(30 \pm 3)$ , different temperature conversion time is 2~3 utes. The temperature cycle shall be repeated 32 cycles. Placed at room temperature for 2 hours, within $48 \pm 4$ hours of testing.
Temperature characteristic	Inductance change Pc-b,Pc-d: Within $\pm 20\%$	a: $+20^{\circ}C$ (30~45) → b: $-40^{\circ}C$ (30~45) → c: $+20^{\circ}C$ (30~45) → d: $+125^{\circ}C$ (30~45) → e: $+20^{\circ}C$ (30~45) $P_{c-b} = \frac{L_b - L_c}{L_c} \times 100\%$ ; $P_{c-d} = \frac{L_d - L_c}{L_c} \times 100\%$
Static Humidity	No visible mechanical damage. Inductance change: Within $\pm 10\%$	Inductors shall be subjected to $(95 \pm 3)\%RH$ . at $(60 \pm 2)^{\circ}C$ for $(1000 \pm 4)$ h. Placed at room temperature for 2 hours, within 48 hours of testing.
	No visible mechanical damage. Inductance change: Within $\pm 10\%$	Inductors shall be store at $(85 \pm 2)^{\circ}C$ for $(1000 \pm 4)$ hours with Irms applied. Placed at room temperature for 2 hours, within 48 hours of testing

## Soldering Condition

**(This is for recommendation, please customer perform adjustment according to actual application)**

Recommend Reflow Soldering Profile : (solder : Sn96.5 / Ag3 / Cu0.5)

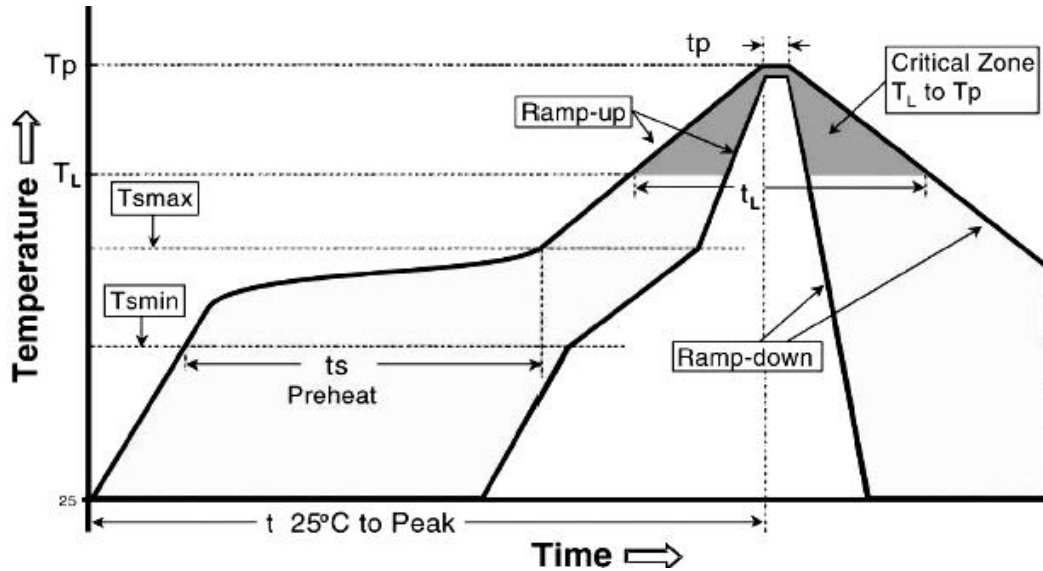

Profile Feature	Lead (Pb)-Free solder
Preheat:	
Temperature Min ( $T_{smin}$ )	150°C
Temperature Max ( $T_{smax}$ )	200°C
Time ( $T_{smin}$ to $T_{smax}$ ) ( $t_s$ )	60 -120 seconds
Average ramp-up rate: ( $T_{smax}$ to $T_p$ )	3°C / second max.
Time maintained above :	
Temperature ( $T_L$ )	217°C
Time ( $t_L$ )	60-150 seconds
Peak Temperature ( $T_p$ )	260°C
Time within $+0$ $-5$ °C of actual peak Temperature ( $t_p$ ) <sup>2</sup>	10 seconds
Ramp-down Rate	6°C/second max.
Time 25°C to Peak Temperature	8minutes max.

Allowed Re-flow times : 2 times

Remark : To avoid discoloration phenomena of chip on terminal electrodes, please use N<sub>2</sub> Re-flow furnace .

## Packing

Dimension of plastic taping: (Unit: mm)

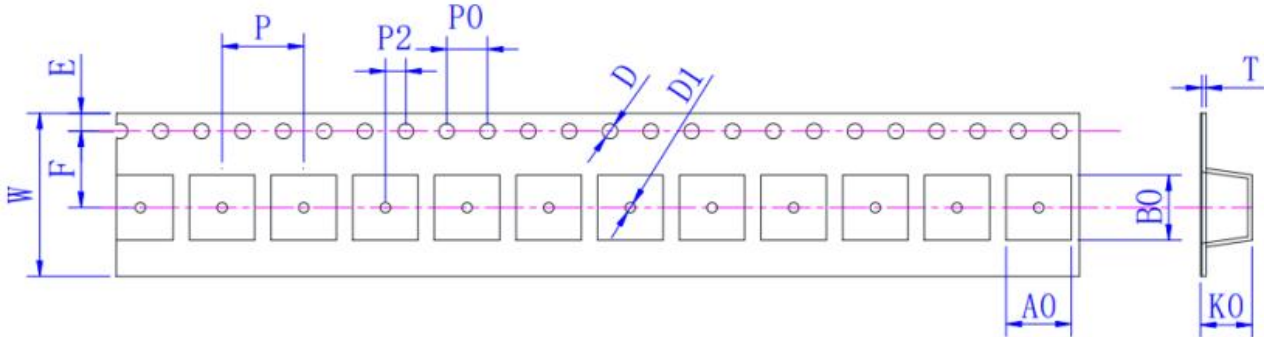

Series	W ±0.30	A0 ±0.05	B0 +0.1/-0	D +0.1/-0	D1 Min	E ±0.10	F ±0.10	K0 ±0.05	P0 ±0.10	P2 ±0.10	P ±0.10	T ±0.05
201265	8.00	1.50	2.30	1.50	1.0	1.75	3.50	0.8	4.00	2.00	4.00	0.23
201208	8.00	1.50	2.30	1.50	1.0	1.75	3.50	1.00	4.00	2.00	4.00	0.23
201210	8.00	1.50	2.30	1.50	1.0	1.75	3.50	1.20	4.00	2.00	4.00	0.23

Dimension of Reel : (Unit: mm)

Type	A ±0.5	B ±0.5	C ±0.5	D ±1
All	178	60	12	1.5

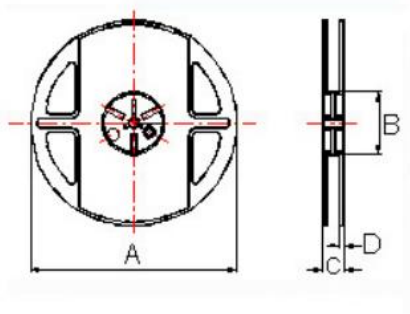

Packing Quantity: 3000pcs/Reel



## X-ON Electronics

Largest Supplier of Electrical and Electronic Components

*Click to view similar products for [Fixed Inductors](#) category:*

*Click to view products by [MetalLions](#) manufacturer:*

Other Similar products are found below :

[CR32NP-100KC](#) [70F224AI](#) [MHQ1005P10NJ](#) [MHQ1005P1N0S](#) [MHQ1005P2N4S](#) [MHQ1005P3N6S](#) [MHQ1005P5N1S](#) [MHQ1005P8N2J](#)  
[PE-53601NL](#) [PE-53602NL](#) [PG0936.113NLT](#) [9220-20](#) [9310-16](#) [PM06-2N7](#) [PM06-39NJ](#) [A01TK](#) [1206CS-471XJ](#) [HC2-R47-R](#) [HC8-1R2-R](#)  
[HCF1305-3R3-R](#) [1206CS-151XG](#) [RCH664NP-4R7M](#) [RCP1317NP-391L](#) [DH2280-4R7M](#) [DS1608C-106](#) [B10TJ](#) [B82498B3101J000](#) [ELJ-](#)  
[RE27NJF2](#) [1812CS-153XJ](#) [1812CS-183XJ](#) [1812CS-223XJ](#) [1812LS-104XJ](#) [1812LS-105XJ](#) [1812LS-124XJ](#) [1812LS-154XJ](#) [1812LS-223XJ](#)  
[1812LS-224XJ](#) [1812LS-563XJ](#) [1812LS-683XJ](#) [1812LS-824XJ](#) [NIN-FB101JTR110F](#) [NIN-FB471JTR62F](#) [NIN-FC1R5JTR220F](#) [NIN-](#)  
[HCR15JTRF](#) [NIN-HCR33JTRF](#) [NIN-HDR22JTRF](#) [NIN-HDR82JTRF](#) [NIN-HK2N7STRF](#) [NIN-PA150KTR370F](#) [NIN-PB100KTR550F](#)