

Systems Configurations

BVX-100 Series Fume Extraction

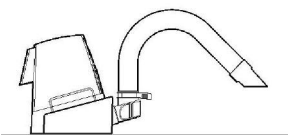

BVX-101
On bench with
exhaust Arm

Other possible configurations:

- On bench with plenum (BVX-101S)
- On shelf with Arm & inverted adapter (BVX-IADT)
- With under bench bracket (BVX-BCK)
- On the floor with flexible Arm kit (BVX-ARM-K1)

BVX-200 Series Fume Extraction

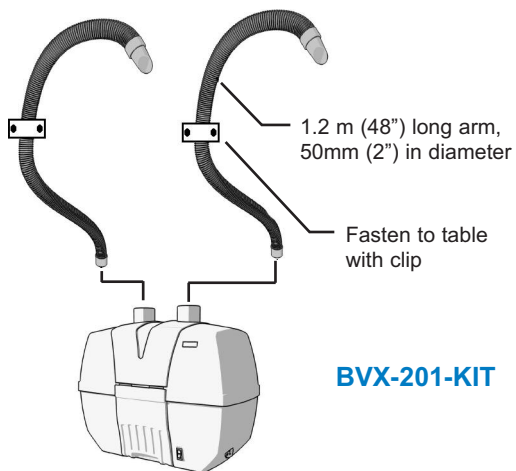

BVX-201-KIT

Other possible configurations:

- BVX-200 with flexible hoses (BVX-Arm-K1) & BVX Arms. The flexible hoses offer greater spacing between arms. For longer hoses you can order individual components (www.okinternational.com/product_fume_bvx/bvx_200)
- BVX-200 with flexible hoses & Omniflex Arms

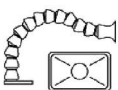

EA1122

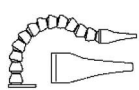

EA1124

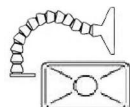

EA1126

Systems Configurations

MFX-2200 Series Fume Extraction

Pre/HEPA/Gas with Exhaust Arms

MFX-2200C-A or MFX-2200C-D

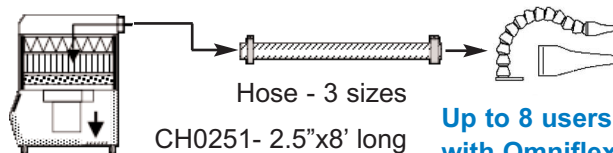

Hose - 3 sizes

- CH0251- 2.5"x8' long
- CH0251- 2.5"x8' long
- CH0251- 2.5"x8' long

Up to 8 users
with Omniflex
Arm EA1124
tapered nozzle

Other possible configurations:

- Up to 4 users with Omniflex Arm EA1122 rectangular nozzle & EA1126 large hood per unit
- Up to 8 users with **BVX-ARM** per unit (BVX-ARM-K2: BVX Arm ESD with nozzle, mounting plate and C-Clamps)

All Arms are supplied with mounting bracket and two C-Clamps.

Pre/Gas with Exhaust Cabinet / ExhaustArms

MFX-2200G-A or MFX-2200G-D

Recommended unit capacity

- 2 Cabinets (EC1500)
- or 1 Cabinet and 2 exhaust Arms
- or 4 exhaust Arms

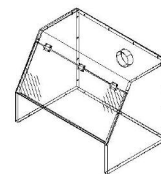

BTX-208 Tip Extraction Duct Layout

The BTX-208 can provide fume extraction for up to 8 stations. Select a duct connection kit based on the number of stations, the layout and the length of ducting.

Connection Kits:

- BTX-CK2-25 - For 2-4 stations with 2.5m (8') long hose
- BTX-CK4-50 - For 4-8 stations with 5m (16') long hose
- BTX-CK4-75 - For 4-8 stations with 7.5m (25') long hose

Contact us for a free configuration & ducting layout. For more information download our Fume Extraction planning guide www.okinternational.com/literature_fume/data_sheets



Fume Extraction Product Guide

Single & Multi Users



Which System Should I Buy?

PARTICULATE

GAS

REPLACEMENT FILTERS

VOLUME EXTRACTION

BVX-100 Series

SINGLE USER

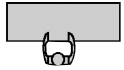

- BVX-101 - Bench-Top Arm System
- BVX-101S - Bench-Top Plenum System
- BVX-103 - Bench-Top Arm System
- BVX-103S - Bench-Top Plenum System

- FP-BVX**
Pre-filter
- FM-BVX**
Main Filter (Combined HEPA/Gas)
- FG-BVX**
Deep Bed Gas

BVX-200 Series

TWO USERS

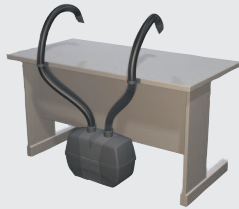
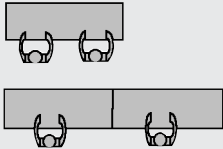

- BVX-201-KIT - Filter unit with 2 flexible arms, 1.2m long
- BVX-201 - Filter unit only for 2 stations (arm not included)
- BVX-203 - Filter unit for 2 stations

- FP-BVX200**
Pre-filter
- FM-BVX200**
Main Filter HEPA Carbon
- FG-BVX200**
Deep Bed Gas Filter

MFX-2200 Series

MULTI USERS
up to 8

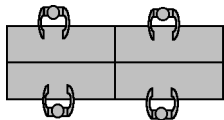

- MFX-2200C-A - Particle Fume Extraction System with analog control
- MFX-2200C-D - Particle Fume Extraction System with digital control
- MFX-2200G-A - Gas Fume Extraction System with analog control
- MFX-2200G-D - Gas Fume Extraction System with digital control

- FIL22P030** for **MFX-2200C**
Pre-filter Pleated 60% efficiency
- FIL22H070** for **MFX-2200C**
Combination Filter HEPA/Carbon
- FIL22P040** for **MFX-2200G**
Pre-filter Pleated 85% efficiency
- FIL22H010** for **MFX-2200G**
Gas Filter Cartridge 11Kg (25lbs)
- FIL22H020** for **MFX-2200G**
Carbon Refill Kit 11Kg 25lbs)

TIP EXTRACTION

BTX-200 Series

MULTI USERS
up to 8

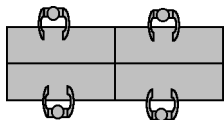

- BTX-208 - Filter Unit for 8 Tip Extraction Stations
- Not Applicable

- FP-BVX200**
Pre-filter
- FM-BVX200**
Main Filter HEPA Carbon

Full range of Connection Kits and Tip Extraction Iron Adapet Kit available at www.okinternational.com/product_fume/btx_208

NEW RELEASE : Universal Iron Adapter Clip - BTX-UC01

X-ON Electronics

Largest Supplier of Electrical and Electronic Components

Click to view similar products for [Soldering Irons](#) category:

Click to view products by [Metcal](#) manufacturer:

Other Similar products are found below :

[0052918099](#) [0058759725](#) [918100-TE](#) [PTTC-802](#) [SFV-DRK30AR](#) [SMTC-0167](#) [SMTC-1121](#) [SMTC-1169-PK](#) [SMTC-588](#) [SMTC-8170](#) [AC-CK1](#) [AC-CK2](#) [SSC-601A](#) [SSC-625A](#) [SSC-626A](#) [SSC-638A](#) [SSC-726A](#) [FG-BVX](#) [STTC-042](#) [STTC-114](#) [STTC-838P](#) [STV-CH24A](#) [SCP-CH25](#) [SMTC-101](#) [SMTC-160-PK](#) [SMTC-1BL250](#) [SSC-645A](#) [SSC-671A](#) [SSC-672A](#) [SSC-742A](#) [SSC-745A](#) [SSC-746A](#) [SSC-770A](#) [SSC-772A](#) [STTC-105](#) [STTC-120](#) [STTC-513](#) [STTC-545](#) [STTC-547](#) [1-91362-0](#) [T0054487399](#) [T0054472199](#) [T0054465699](#) [STTC-820](#) [SCV-CH30AR](#) [T0054440699](#) [PTTC-801B](#) [STTC-845P](#) [RPS-1](#) [SMTC-006](#)