

Cartridge Selection Guide

CV & MX Soldering/Desoldering/Rework Systems



ConnectionValidation™ (CV) & MX Cartridges

For use with:

CV-5200 Series

CV-500 Series

MX-5000 Series

MX-5200 Series

MX-500 Series

Contents

Cartridges for CV and MX Soldering Systems

<u>CV/MX-Series</u>	<u>Type</u>	<u>Page</u>
CVC/STTC	Soldering Cartridges - Bevel Cartridges	1
CVC/STTC	Soldering Cartridges – Chisel	2 - 4
CVC/STTC	Solder Cartridges - Conical	5 - 6
CVC/STTC	Soldering Cartridges - U-/V-Groove	7
SMC/SMTC	Rework Cartridges - Blade	8
SMC/SMTC	Rework Cartridges - Hoof	9 - 10
SMC/SMTC	Rework Cartridges - Hook	10
SMC/SMTC	Rework Cartridges - Knife	10
UFC/--	UltraFine Cartridges - Chisel	11
UFC/--	UltraFine Cartridges - Conical	11 - 12
UFC/--	UltraFine Cartridges – Hoof	12
HCV/HTC	High Thermal Demand Cartridges	13 - 14
PTC/PTTC	Tweezer Cartridges	15 - 16
UFT/--	UltraFine Tweezer Cartridges	17
DSC/STDC	De-Solder Cartridges	18



CVC Cartridges are compatible with MX-500, MX-5000, MX-5200 and CV-5200, CV-500 Systems - MX-RM3E, MX-RM6E, MX-H1-AV, MX-H7-SF - CV-H1-AV and CV-H7-AV Solder Hand pieces.

STTC Cartridges are compatible with MX-500, MX-5000 and MX-5200 Systems – MX-RM3E, MX-RM6E, MX-H1-AV and MX-H7-SF Solder Hand pieces.



Temperature	CV-Series	MX-Series	Application
575 °F/302 °C	CVC-5xxx	STTC-5xx	Temperature Sensitive
675 °F/357 °C	CVC-6xxx	STTC-0xx	
775 °F/413 °C	CVC-7xxx	STTC-1xx	Most Standard
875 °F/468 °C	CVC-8xxx	STTC-8xxV1	Ceramic and High Thermal Demand
950 °F/510 °C	CVC-9xxx	STTC-8xx	

Please note the above temperatures are the maximum temperatures of the heater. The idle temperature is dependent on the geometry of the cartridge.

Bevel Cartridges				
	CVC-5BV6005A CVC-6BV6005A CVC-7BV6005A CVC-8BV6005A CVC-9BV6005A	STTC-546 STTC-046 STTC-146 STTC-846V1 STTC-846	Long reach, (Bevel/L) 60° x 1 mm, (ø x L) 0.50 x 14.2 mm	
	CVC-5BV6018P CVC-6BV6018P CVC-7BV6018P CVC-8BV6018P CVC-9BV6018P	STTC-547P STTC-047P STTC-147P STTC-847PV1 STTC-847P	(Bevel/L) 60° x 1.78 mm, optimised geometry for best thermal performance (ø x L) 0.89 x 6.6 mm	
	CVC-5BV6018R CVC-6BV6018R CVC-7BV6018R CVC-8BV6018R CVC-9BV6018R	STTC-547 STTC-047 STTC-147 STTC-847V1 STTC-847	Long reach, (Bevel/L) 70° x 1.78 mm, (ø x L) 0.83 x 14.2 mm	
	CVC-5BV4001S CVC-6BV4001S CVC-7BV4001S CVC-8BV4001S CVC-9BV4001S	STTC-524 STTC-024 STTC-124 STTC-824V1 STTC-824	(Bevel/L) 30° x 1.49 mm, (ø x L) 1.23 x 9.3 mm	
	CVC-5BV3018P CVC-6BV3018P CVC-7BV3018P CVC-8BV3018P CVC-9BV3018P	STTC-515 STTC-015 STTC-115 STTC-815V1 STTC-815	(Bevel/L 30°) x 1.47 mm, optimised geometry for best thermal performance, (ø x L) 1.3 x 3.9 mm	
	CVC-5BV6018S CVC-6BV6018S CVC-7BV6018S CVC-8BV6018S CVC-9BV6018S	STTC-535 STTC-035 STTC-135 STTC-835V1 STTC-835	(Bevel/L) 30° x 2.06 mm, (ø x L) 1.78 x 9.9 mm	
	CVC-5BV3018S CVC-6BV3018S CVC-7BV3018S CVC-8BV3018S CVC-9BV3018S	STTC-505 STTC-005 STTC-105 STTC-805V1 STTC-805	(Bevel/L) 30° x 2.06 mm, (ø x L) 1.78 x 11.7 mm	

Chisel Cartridges

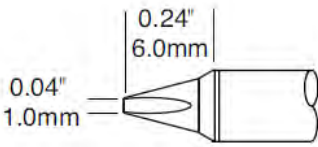
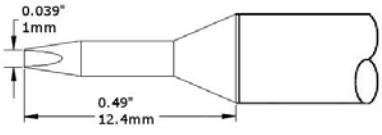
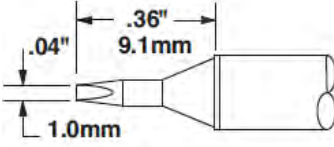
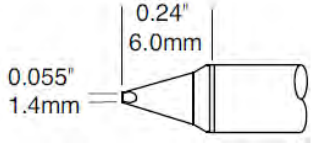
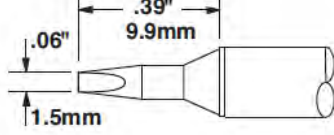
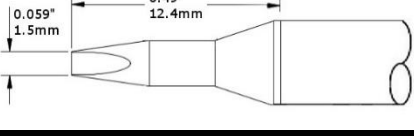
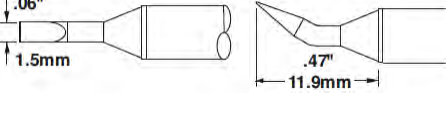
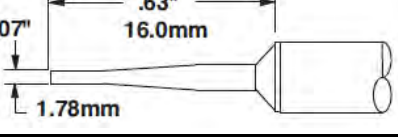
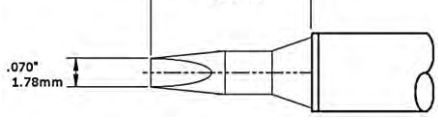
	CVC-5CH0010P CVC-6CH0010P CVC-7CH0010P CVC-8CH0010P CVC-9CH0010P	STTC-525P STTC-025P STTC-125P STTC-825PV1 STTC-825P	Optimised geometry for best thermal performance, (W x L) 1.0 x 6.0 mm
	CVC-5CH0010A CVC-6CH0010A CVC-7CH0010A CVC-8CH0010A CVC-9CH0010A	N/A	Long reach, for work in tight spaces, (W x L) 1.0 x 12.4 mm
	CVC-5CH0010S CVC-6CH0010S CVC-7CH0010S CVC-8CH0010S CVC-9CH0010S	STTC-525 STTC-025 STTC-125 STTC-825V1 STTC-825	(W x L) 1.0 x 9.1 mm
	CVC-5CH0014P CVC-6CH0014P CVC-7CH0014P CVC-8CH0014P CVC-9CH0014P	STTC-538P STTC-038P STTC-138P STTC-838PV1 STTC-838P	Optimised geometry for best thermal performance, (W x L) 1.4 x 6.0 mm
	CVC-5CH0014S CVC-6CH0014S CVC-7CH0014S CVC-8CH0014S CVC-9CH0014S	STTC-538 STTC-038 STTC-138 STTC-838V1 STTC-838	(W x L) 1.5 x 9.9 mm
	CVC-5CH0015A CVC-6CH0015A CVC-7CH0015A CVC-8CH0015A CVC-9CH0015A	N/A	Long reach, for work in tight spaces, (W x L) 1.5 x 12.4 mm
	CVC-5CH0015R CVC-6CH0015R CVC-7CH0015R CVC-8CH0015R CVC-9CH0015R	STTC-599 STTC-099 STTC-199 STTC-899V1 STTC-899	Bent 30°, for work under a microscope, (W x L) 1.5 x 11.9 mm
	CVC-5CH0018A CVC-6CH0018A CVC-7CH0018A CVC-8CH0018A CVC-9CH0018A	STTC-542 STTC-042 STTC-142 STTC-842V1 STTC-842	Long reach, flat, (W x L) 1.78 x 16mm
	CVC-5CH0018L CVC-6CH0018L CVC-7CH0018L CVC-8CH0018L CVC-9CH0018L	STTC-537LL STTC-037LL STTC-137LL STTC-837LLV1 STTC-837LL	Long life plating, (W x L) 1.78 x 10 mm

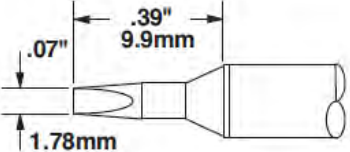
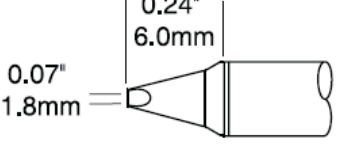
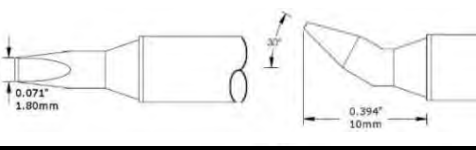
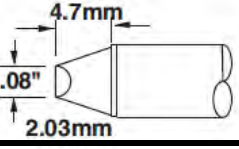
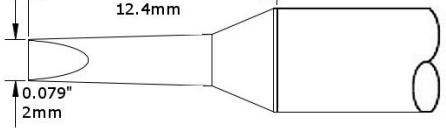
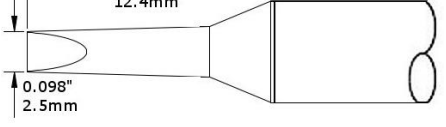
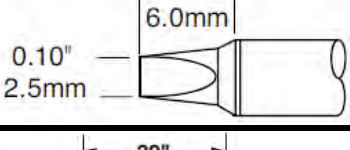
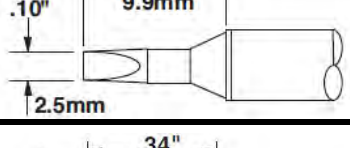
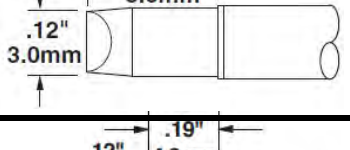
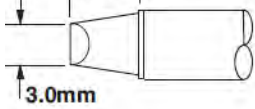

Chisel Cartridges

	CVC-5CH0018S CVC-6CH0018S CVC-7CH0018S CVC-8CH0018S CVC-9CH0018S	STTC-537 STTC-037 STTC-137 STTC-837V1 STTC-837	(W x L) 1.78 x 9.9 mm
	CVC-5CH0018P CVC-6CH0018P CVC-7CH0018P CVC-8CH0018P CVC-9CH0018P	STTC-537P STTC-037P STTC-137P STTC-837PV1 STTC-837P	Optimised geometry for best thermal performance, (W x L) 1.8 x 6.0 mm
	CVC-5CH0018R CVC-6CH0018R CVC-7CH0018R CVC-8CH0018R CVC-9CH0018R	STTC-598 STTC-098 STTC-198 STTC-898V1 STTC-898	Bend 30°, for work under a microscope, (W x L) 1.8 x 10.0 mm
	CVC-5CH0020S CVC-6CH0020S CVC-7CH0020S CVC-8CH0020S CVC-9CH0020S	STTC-514 STTC-014 STTC-114 STTC-814V1 STTC-814	Optimised geometry for best thermal performance, (W x L) 2.0 x 4.7 mm
	CVC-5CH0020A CVC-6CH0020A CVC-7CH0020A CVC-8CH0020A CVC-9CH0020A	N/A	Long reach, for work in tight spaces, (W x L) 2.0 x 12.4 mm
	CVC-5CH0025A CVC-6CH0025A CVC-7CH0025A CVC-8CH0025A CVC-9CH0025A	N/A	Long reach, for work in tight spaces, (W x L) 2.5 x 12.4 mm
	CVC-5CH0025P CVC-6CH0025P CVC-7CH0025P CVC-8CH0025P CVC-9CH0025P	STTC-536P STTC-036P STTC-136P STTC-836PV1 STTC-836P	Optimised geometry for best thermal performance, (W x L) 2.5 x 6.0 mm
	CVC-5CH0025S CVC-6CH0025S CVC-7CH0025S CVC-8CH0025S CVC-9CH0025S	STTC-536 STTC-036 STTC-136 STTC-836V1 STTC-836	(W x L) 2.5 x 9.9 mm
	CVC-5CH0034S CVC-6CH0034S CVC-7CH0034S CVC-8CH0034S CVC-9CH0034S	STTC-503 STTC-003 STTC-103 STTC-803V1 STTC-803	(W x L) 3.0 x 8.6 mm
	CVC-5CH0030S CVC-6CH0030S CVC-7CH0030S CVC-8CH0030S CVC-9CH0030S	STTC-513 STTC-013 STTC-113 STTC-813V1 STTC-813	Optimised geometry for best thermal performance (W x L) 3.0 x 4.8 mm

Chisel Cartridges

	CVC-5CH0035S CVC-6CH0035S CVC-7CH0035S CVC-8CH0035S CVC-9CH0035S	N/A	(W x L) 3.5 x 8.13 mm
	CVC-5CH0035P CVC-6CH0035P CVC-7CH0035P CVC-8CH0035P CVC-9CH0035P	N/A	Optimised geometry for best thermal performance, (W x L) 3.5 x 6.13 mm
	CVC-5CH2238A CVC-6CH2238A CVC-7CH2238A CVC-8CH2238A CVC-9CH2238A	STTC-520 STTC-020 STTC-120 STTC-820V1 STTC-820	Long reach, flat, for work in tight spaces, (W x L) 3.8 x 21.6 mm
	CVC-5CH0040P CVC-6CH0040P CVC-7CH0040P CVC-8CH0040P CVC-9CH0040P	N/A	Optimised geometry for best thermal performance, (W x L) 4.2 x 6.0 mm
	CVC-5CH0040S CVC-6CH0040S CVC-7CH0040S CVC-8CH0040S CVC-9CH0040S	N/A	(W x L) 4.2 x 7.6 mm
	CVC-5CH0050A CVC-6CH0050A CVC-7CH0050A CVC-8CH0050A CVC-9CH0050A	STTC-565 STTC-065 STTC-165 STTC-865V1 STTC-865	Long reach, (W x L) 5.0 x 11.4 mm
	CVC-5CH0050S CVC-6CH0050S CVC-7CH0050S CVC-8CH0050S CVC-9CH0050S	STTC-517 STTC-017 STTC-117 STTC-817V1 STTC-817	(W x L) 5.0 x 7.6 mm
	CVC-5CH0050P CVC-6CH0050P CVC-7CH0050P CVC-8CH0050P CVC-9CH0050P	N/A	Optimised geometry for best thermal performance, (W x L) 5.23 x 6.0 mm

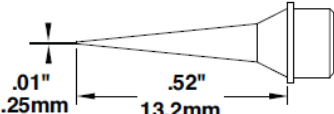
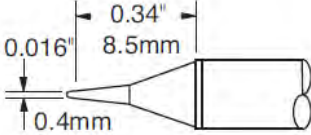
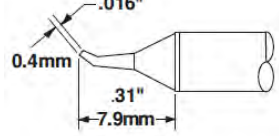
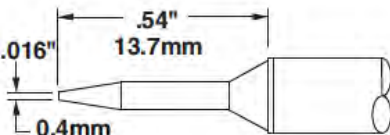
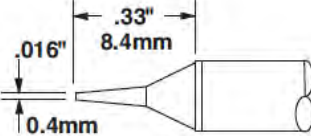
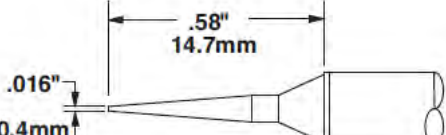
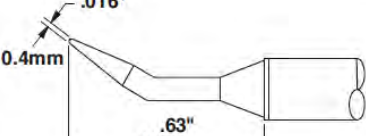
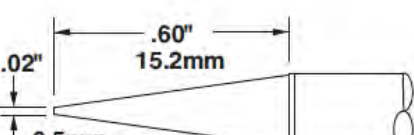
Conical Cartridges

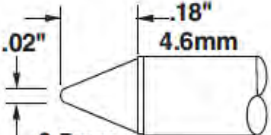
	CVC-5CN0003A CVC-6CN0003A CVC-7CN0003A CVC-8CN0003A CVC-9CN0003A	STTC-590 STTC-090 STTC-190 STTC-890V1 STTC-890	Fine, long reach, for work in tight spaces, (ø x L) 0.25 x 13.2 mm
	CVC-5CN0004P CVC-6CN0004P CVC-7CN0004P CVC-8CN0004P CVC-9CN0004P	STTC-545P STTC-045P STTC-145P STTC-845PV1 STTC-845P	Sharp, optimised geometry for best thermal performance, (ø x L) 0.4 x 8.5 mm
	CVC-5CN0004R CVC-6CN0004R CVC-7CN0004R CVC-8CN0004R CVC-9CN0004R	STTC-526 STTC-026 STTC-126 STTC-826V1 STTC-826	Sharp, Bent 30°, for work under a microscope, (ø x L) 0.4 x 7.9 mm
	CVC-5CN1304A CVC-6CN1304A CVC-7CN1304A CVC-8CN1304A CVC-9CN1304A	STTC-506 STTC-006 STTC-106 STTC-806V1 STTC-806	Sharp, long reach, (ø x L) 0.4 x 13.7 mm
	CVC-5CN1404S CVC-6CN1404S CVC-7CN1404S CVC-8CN1404S CVC-9CN1404S	STTC-522 STTC-022 STTC-122 STTC-822V1 STTC-822	Sharp, (ø x L) 0.4 x 8.4 mm
	CVC-5CN1504A CVC-6CN1504A CVC-7CN1504A CVC-8CN1504A CVC-9CN1504A	STTC-545 STTC-045 STTC-145 STTC-845V1 STTC-845	Sharp, long Reach, (ø x L) 0.4 x 14.7 mm
	CVC-5CN1604R CVC-6CN1604R CVC-7CN1604R CVC-8CN1604R CVC-9CN1604R	N/A	Sharp, long reach, bent 30°, for work under a microscope, (ø x L) 0.4 x 16 mm
	CVC-5CN0005A CVC-6CN0005A CVC-7CN0005A CVC-8CN0005A CVC-9CN0005A	STTC-543 STTC-043 STTC-143 STTC-843V1 STTC-843	Sharp, long reach, (ø x L) 0.5 x 15.2 mm
	CVC-5CN0005R CVC-6CN0005R CVC-7CN0005R CVC-8CN0005R CVC-9CN0005R	STTC-544 STTC-044 STTC-144 STTC-844V1 STTC-844	Sharp, long reach, bent 30°, for work under a microscope, (ø x L) 0.5 x 14.5 mm
	CVC-5CN0005S CVC-6CN0005S CVC-7CN0005S CVC-8CN0005S CVC-9CN0005S	STTC-511 STTC-011 STTC-111 STTC-811V1 STTC-811	Blunt, optimised geometry for best thermal performance, (ø x L) 0.5 x 4.6 mm

Conical Cartridges

	CVC-5CN4805S CVC-6CN4805S CVC-7CN4805S CVC-8CN4805S CVC-9CN4805S	STTC-516 STTC-016 STTC-116 STTC-816V1 STTC-816	Blunt, optimised geometry for best thermal performance, (ϕ x L) 0.5 x 4.8 mm
	CVC-5CN1608R CVC-6CN1608R CVC-7CN1608R CVC-8CN1608R CVC-9CN1608R	STTC-540 STTC-040 STTC-140 STTC-840V1 STTC-840	Sharp, long reach, bent 30°, for work under a microscope, (ϕ x L) 0.8 x 16 mm
	CVC-5CN0010A CVC-6CN0010A CVC-7CN0010A CVC-8CN0010A CVC-9CN0010A	STTC-501 STTC-001 STTC-101 STTC-801V1 STTC-801	Long reach, (ϕ x L) 1.0 x 13.5 mm
	CVC-5CN0010P CVC-6CN0010P CVC-7CN0010P CVC-8CN0010P CVC-9CN0010P	STTC-501P STTC-001P STTC-101P STTC-801PV1 STTC-801P	Optimised geometry for best thermal performance, (ϕ x L) 1.0 x 6.5 mm
	CVC-5CN0010S CVC-6CN0010S CVC-7CN0010S CVC-8CN0010S CVC-9CN0010S	STTC-531 STTC-031 STTC-131 STTC-831V1 STTC-831	(ϕ x L) 1.0 x 9.9 mm
	CVC-5CN1710A CVC-6CN1710A CVC-7CN1710A CVC-8CN1710A CVC-9CN1710A	STTC-507 STTC-007 STTC-107 STTC-807V1 STTC-807	Long reach, (ϕ x L) 1.0 x 16.7 mm
	CVC-5CN0013R CVC-6CN0013R CVC-7CN0013R CVC-8CN0013R CVC-9CN0013R	STTC-541 STTC-041 STTC-141 STTC-841V1 STTC-841	Bent 30°, for work under a microscope, Long Reach, (ϕ x L) 1.3 x 21.8 mm
	CVC-5CN1002S CVC-6CN1002S CVC-7CN1002S CVC-8CN1002S CVC-9CN1002S	STTC-532 STTC-032 STTC-132 STTC-832V1 STTC-832	Blunt, (ϕ x L) 1.52 x 9.78 mm
	CVC-5CN1208S CVC-6CN1208S CVC-7CN1208S CVC-8CN1208S CVC-9CN1208S	STTC-502 STTC-002 STTC-102 STTC-802V1 STTC-802	(ϕ x L) 1.8 x 12 mm
	CVC-5CN4302S CVC-6CN4302S CVC-7CN4302S CVC-8CN4302S CVC-9CN4302S	STTC-512 STTC-012 STTC-112 STTC-812V1 STTC-812	Blunt, optimised geometry for best thermal performance, (ϕ x L) 2.0 x 4.3 mm

N/A

U- / V-Groove Cartridges – For Pin Soldering

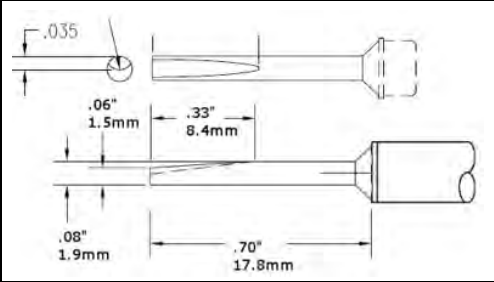
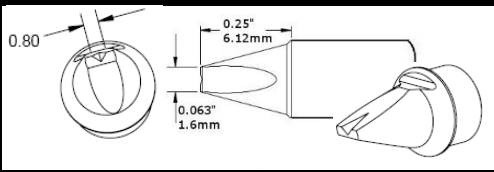
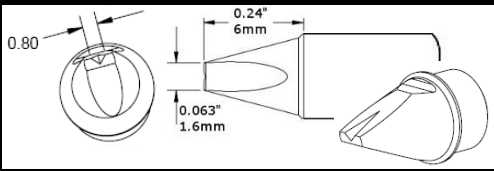
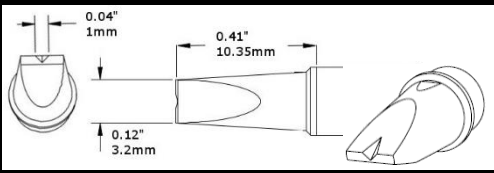
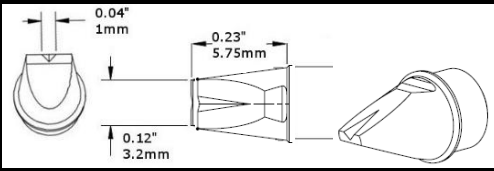
	<p>CVC-5LG1802A CVC-6LG1802A CVC-7LG1802A CVC-8LG1802A</p>	<p>STTC-583 STTC-083 STTC-183 STTC-883V1</p>	<p>U-Groove for pin soldering, groove (ø x L) 0.89 x 8.4 mm, (Total ø x L) 1.9 x 17.8 mm</p>
	<p>CVC-5VG0016A CVC-6VG0016A CVC-7VG0016A CVC-8VG0016A CVC-9VG0016A</p>	<p>N/A</p>	<p>V-Groove for pin soldering, groove (W x L) 0.8 x 3 mm, (W x L) 1.6 x 6.12 mm</p>
	<p>CVC-5VG0016P CVC-6VG0016P CVC-7VG0016P CVC-8VG0016P CVC-9VG0016P</p>	<p>N/A</p>	<p>V-Groove for pin soldering, optimised geometry for best thermal performance, groove (W x L) 0.8 x 3,5 mm, (W x L) 1.6 x 6 mm</p>
	<p>CVC-5VG0032A CVC-6VG0032A CVC-7VG0032A CVC-8VG0032A CVC-9VG0032A</p>	<p>N/A</p>	<p>V-Groove for pin soldering, groove (W x L) 1.0 x 3 mm, (W x L) 3.2 x 10.35 mm</p>
	<p>CVC-5VG0032P CVC-6VG0032P CVC-7VG0032P CVC-8VG0032P CVC-9VG0032P</p>	<p>N/A</p>	<p>V-Groove for pin soldering, optimised geometry for best thermal performance, groove (W x L) 1.0 x 4 mm, (W x L) 3.2 x 5.75 mm</p>

SMC Rework Cartridges are compatible with MX-500, MX-5000, MX-5200 and CV-5200, CV-500 Systems – MX-RM3E, MX-RM6E, MX-H1-AV, CV-H1-AV Solder Hand pieces.

SMTC Rework Cartridges are compatible with MX-500, MX-5000 and MX-5200 Systems MX-RM3E, MX-RM6E and MX-H1-AV Solder Hand pieces.



Temperature	CV-Series	MX-Series	Application
575 °F/302 °C	SMC-5xxx	SMTC-5xx	Temperature Sensitive
675 °F/357 °C	SMC-6xxx	SMTC-0xx	
775 °F/413 °C	SMC-7xxx	SMTC-1xx	Most Standard
875 °F/468 °C	SMC-8xxx	SMTC-8xxV1	Ceramic and High Thermal Demand
950 °F/510 °C	SMC-9xxx	SMTC-8xx	

Please note the above temperatures are the maximum temperatures of the heater. The idle temperature is dependent on the geometry of the cartridge.

These tips will provide data via the CV series power supplies, but due to the nature of their application the Connection Validation function is not required and therefore not enabled.

Blades for Rework Applications				
	SMC-5BL0010S SMC-6BL0010S SMC-7BL0010S SMC-8BL0010S SMC-9BL0010S	SMTC-560 SMTC-060 SMTC-160 SMTC-860V1 SMTC-860	Blade for Pad Clean-Up, A = 10 mm H = 9.14 mm	
	SMC-5BL0015H SMC-6BL0015H SMC-7BL0015H SMC-8BL0015H SMC-9BL0015H	SMTC-5BL150 SMTC-0BL150 SMTC-1BL150 SMTC-8BL150V1 SMTC-8BL150	Blade for Pad Clean-Up, L = 15 mm H = 9.1 mm	
	SMC-5BL0016S SMC-6BL0016S SMC-7BL0016S SMC-8BL0016S SMC-9BL0016S	SMTC-561 SMTC-061 SMTC-161 SMTC-861V1 SMTC-861	Blade for Pad Clean-Up, A = 15.75 mm H = 9.14 mm	
	SMC-5BL0022S SMC-6BL0022S SMC-7BL0022S SMC-8BL0022S SMC-9BL0022S	SMTC-562 SMTC-062 SMTC-162 SMTC-862V1 SMTC-862	Blade for Pad Clean-Up, A = 22 mm H = 9.14 mm	
	SMC-5BL0025H SMC-6BL0025H SMC-7BL0025H SMC-8BL0025H SMC-9BL0025H	SMTC-5BL250 SMTC-0BL250 SMTC-1BL250 SMTC-8BL250V1 SMTC-8BL250	Blade for Pad Clean-Up, L = 25 mm H = 9.1 mm	
	SMC-5BL0035H SMC-6BL0035H SMC-7BL0035H SMC-8BL0035H SMC-9BL0035H	SMTC-5BL350 SMTC-0BL350 SMTC-1BL350 SMTC-8BL350V1 SMTC-8BL350	Blade for Pad Clean-Up, L = 35 mm H = 9.1 mm	

Rework Hoof-Cartridges – For Drag Soldering SOICs/QFPs

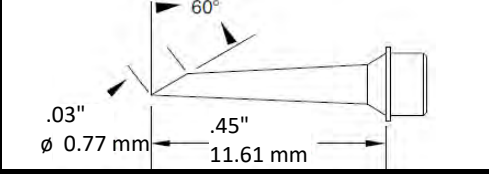
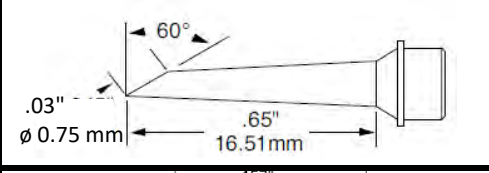
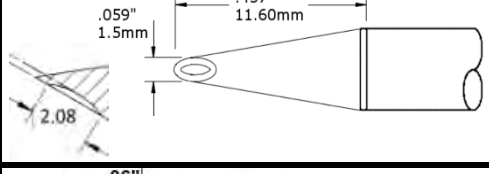
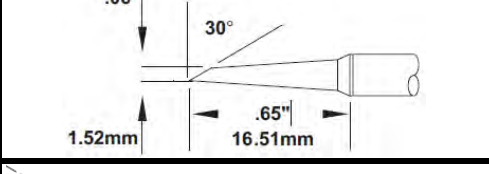
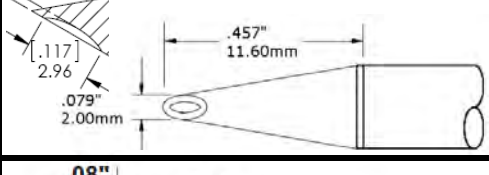
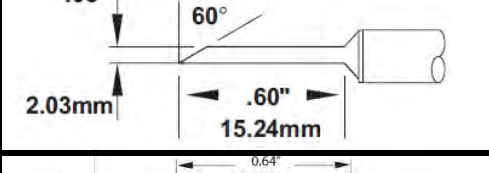
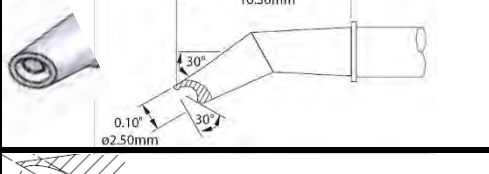
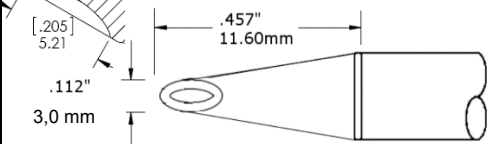
	SMC-5HF6009S SMC-6HF6009S SMC-7HF6009S SMC-8HF6009S SMC-9HF6009S	SMTC-5175 SMTC-0175 SMTC-1175 SMTC-8175V1 SMTC-8175	Micro Hoof, (Bevel/L) 60° x 1.54 mm, (∅ x L) 0.77 x 11.61 mm
	SMC-5HF6011S SMC-6HF6011S SMC-7HF6011S SMC-8HF6011S SMC-9HF6011S	SMTC-5174 SMTC-0174 SMTC-1174 SMTC-8174V1 SMTC-8174	Micro Hoof, (Bevel/L) 60° x 1.5 mm, long reach, (∅ x L) 0.75 x 16.51 mm
	SMC-5HF0015V SMC-6HF0015V SMC-7HF0015V SMC-8HF0015V SMC-9HF0015V	SMTC-5184 SMTC-0184 SMTC-1184 SMTC-8184V1 SMTC-8184	Concave Hoof, (Bevel/L) 60° x 3 mm, (∅ x L) 1.5 x 11.6 mm
	SMC-5HF6015S SMC-6HF6015S SMC-7HF6015S SMC-8HF6015S SMC-9HF6015S	SMTC-5167 SMTC-0167 SMTC-1167 SMTC-8167V1 SMTC-8167	Hoof, (Bevel/L) 30° x 1.76 mm, long reach, (∅ x L) 1.52 x 16.51 mm
	SMC-5HF0020V SMC-6HF0020V SMC-7HF0020V SMC-8HF0020V SMC-9HF0020V	SMTC-5185 SMTC-0185 SMTC-1185 SMTC-8185V1 SMTC-8185	Concave Hoof, (Bevel/L) 60° x 4 mm, (∅ x L) 2.0 x 11.6 mm
	SMC-5HF6020S SMC-6HF6020S SMC-7HF6020S SMC-8HF6020S SMC-9HF6020S	SMTC-5169 SMTC-0169 SMTC-1169 SMTC-8169V1 SMTC-8169	Hoof, (Bevel/L) 60° x 4.06 mm, (∅ x L) 2.03 x 15.24 mm
	SMC-5HF3025S SMC-6HF3025S SMC-7HF3025S SMC-8HF3025S SMC-9HF3025S	SMTC-5183 SMTC-0183 SMTC-1183 SMTC-8183V1 SMTC-8183	Concave Hoof, (Bevel/L) 30° x 2.9 mm, bent 30°, (∅ x L) 2.5 x 16.0 mm
	SMC-5HF0030V SMC-6HF0030V SMC-7HF0030V SMC-8HF0030V SMC-9HF0030V	SMTC-5186 SMTC-0186 SMTC-1186 SMTC-8186V1 SMTC-8186	Concave Hoof, (Bevel/L) 60° x 6 mm, (∅ x L) 3.0 x 11.6 mm

Rework Hoof-Cartridges – For Drag Soldering SOICs/QFPs

	SMC-5HF6030S SMC-6HF6030S SMC-7HF6030S SMC-8HF6030S SMC-9HF6030S	SMTC-5170 SMTC-0170 SMTC-1170 SMTC-8170V1 SMTC-8170	Hoof, (Bevel/L) 60° x 6.1 mm, long reach, (ø x L) 3.05 x 15.24mm
	SMC-5HF6033S SMC-6HF6033S SMC-7HF6033S SMC-8HF6033S SMC-9HF6033S	SMTC-5147 SMTC-0147 SMTC-1147 SMTC-8147V1 SMTC-8147	Hoof, (Bevel/L) 60° x 6.6 mm, long reach, (ø x L) 3.3 x 17.78 mm

Special Rework Cartridges

	SMC-5HK0005S SMC-6HK0005S SMC-7HK0005S SMC-8HK0005S SMC-9HK0005S	SMTC-5172 SMTC-0172 SMTC-1172 SMTC-8172V1 SMTC-8172	Hook – for fine drag- and point-to-point soldering on contacts from J-lead components, bend 30°, (ø x L) 0.51 x 15.24 mm
	SMC-5HK0008S SMC-6HK0008S SMC-7HK0008S SMC-8HK0008S SMC-9HK0008S	SMTC-5171 SMTC-0171 SMTC-1171 SMTC-8171V1 SMTC-8171	Used to remove small components like 0201 and 0402 components from a “topside” angle, bent 30° for work under a microscope, (ø x L) 0.76 x 16.51 mm

Rework Knife-Cartridges – For Multi-Lead Soldering of PLCCs/SOJs







	SMC-5KN0025S SMC-6KN0025S SMC-7KN0025S SMC-8KN0025S SMC-9KN0025S	SMTC-5165 SMTC-0165 SMTC-1165 SMTC-8165V1 SMTC-8165	Knife, 45° angled, tinned area length 2.03 mm (W x L) 2.5 x 12.0 mm
	SMC-5KN0048S SMC-6KN0048S SMC-7KN0048S SMC-8KN0048S SMC-9KN0048S	SMTC-5161 SMTC-0161 SMTC-1161 SMTC-8161V1 SMTC-8161	Knife, 45° angled, - tinned area length 2.03 mm, (W x L) 4.83 x 16.51 mm
	SMC-5KN0048W SMC-6KN0048W SMC-7KN0048W SMC-8KN0048W SMC-9KN0048W	SMTC-5173 SMTC-0173 SMTC-1173 SMTC-8173V1 SMTC-8173	Knife, 45° angled, tinned area length 5.84 mm, (W x L) 4.83 x 16.51 mm
	SMC-5KN0050P SMC-6KN0050P SMC-7KN0050P SMC-8KN0050P SMC-9KN0050P	STTC-5173P STTC-0173P STTC-1173P STTC-8173PV1 STTC-8173P	Knife, 45° angled, Optimised geometry for best thermal performance, tinned area length 5.6 mm, (W x L) 5.0 x 13.2 mm
	SMC-5KN0050X SMC-6KN0050X SMC-7KN0050X SMC-8KN0050X SMC-9KN0050X	STTC-5173PLL STTC-0173PLL STTC-1173PLL STTC-8173PLL1 STTC-8173PLL	Knife, 45° angled, Long Life, optimised geometry for best thermal performance, tinned area length 5.6 mm, (W x L) 5.0 x 13.2 mm

UFC Ultra-Fine Cartridges for work in tight spaces, compatible with CV-5200, CV-500 Systems and Ultra-Fine Solder Hand piece CV-H2-UF.

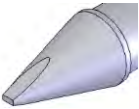
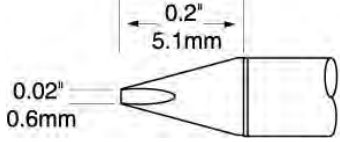

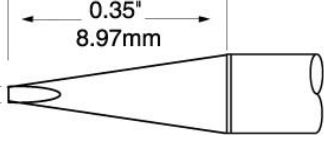
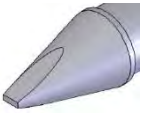
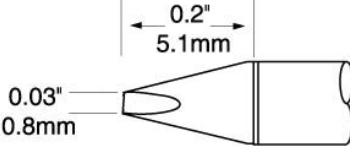
Temperature	CV-Series	Application
675 °F/357 °C	UFC-6	Temperature Sensitive
775 °F/413 °C	UFC-7	Most Standard

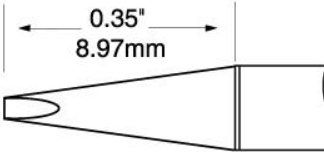
Please note the above temperatures are the maximum temperatures of the heater. The idle temperature is dependent on the geometry of the cartridge.

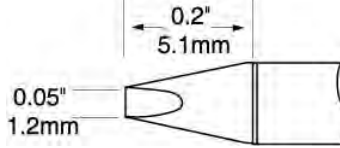
Ultra-Fine Chisel Cartridge			
		UFC-6CH5106S UFC-7CH5106S	(W x L) 0.6 x 5.1 mm
		UFC-6CH9006S UFC-7CH9006S	Long reach, (W x L) 0.6 x 9 mm
		UFC-6CH5108S UFC-7CH5108S	(W x L) 0.8 x 5.1 mm
		UFC-6CH9008S UFC-7CH9008S	Long reach, (W x L) 0.8 x 9 mm
		UFC-6CH5112S UFC-7CH5112S	(W x L) 1.2 x 5.1 mm

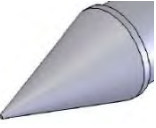
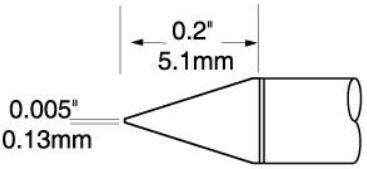
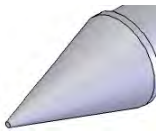
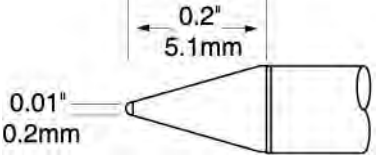
Ultra-Fine Conical Cartridge			
		UFC-6CN5101S UFC-7CN5101S	(ϕ x L) 0.13 x 5.1 mm
		UFC-6CN5102S UFC-7CN5102S	(ϕ x L) 0.2 x 5.1 mm

Ultra-Fine Conical Cartridge

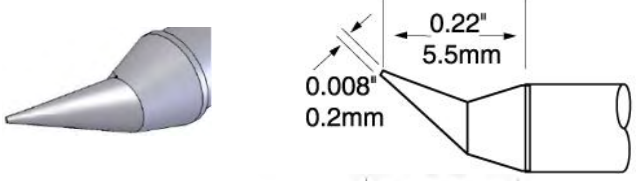
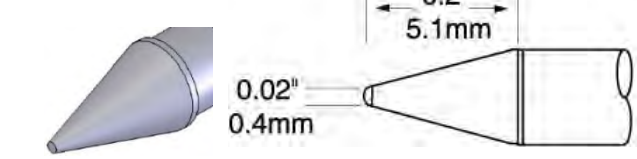
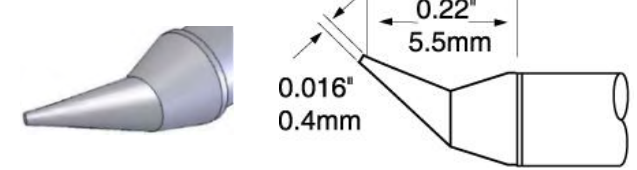
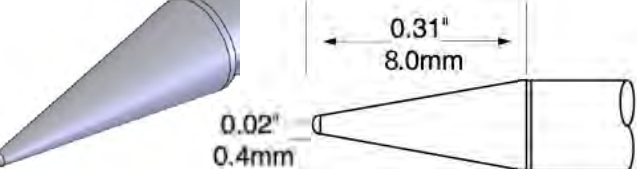
 <p>0.008" 0.2mm</p> <p>0.22" 5.5mm</p>	<p>UFC-6CN5502R UFC-7CN5502R</p>	<p>Bent 30°, for work under a microscope, (ϕ x L) 0.2 x 5.6 mm</p>
 <p>0.02" 0.4mm</p> <p>0.2" 5.1mm</p>	<p>UFC-6CN5504S UFC-7CN5504S</p>	<p>0.4 x 5.1 mm</p>
 <p>0.016" 0.4mm</p> <p>0.22" 5.5mm</p>	<p>UFC-6CN5504R UFC-7CN5504R</p>	<p>Bent 30°, for work under a microscope, 0.4 x 5.6 mm</p>
 <p>0.02" 0.4mm</p> <p>0.31" 8.0mm</p>	<p>UFC-6CN8004S UFC-7CN8004S</p>	<p>For work in tight spaces, long reach, 0.4 x 8.0 mm</p>

Ultra-Fine Rework Hoof-Cartridges – For Drag Soldering SOICs/QFPs

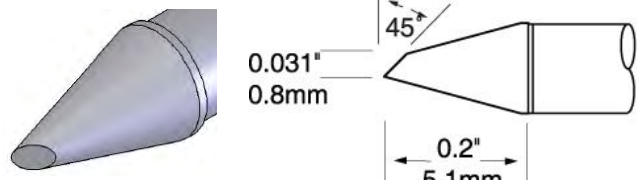
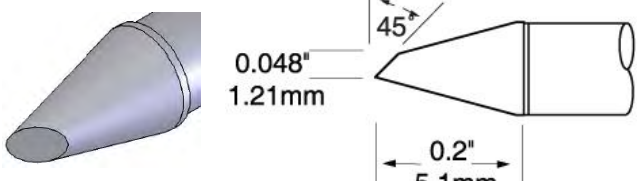
 <p>0.031" 0.8mm</p> <p>45°</p> <p>0.2" 5.1mm</p>	<p>UFC-6HF5108S UFC-7HF5108S</p>	<p>Micro Hoof, (Bevel/L) 45° x 1.13 mm, (ϕ x L) 0.8 x 5.1 mm</p>
 <p>0.048" 1.21mm</p> <p>45°</p> <p>0.2" 5.1mm</p>	<p>UFC-6HF5112S UFC-7HF5112S</p>	<p>Micro Hoof, (Bevel/L) 45° x 1.71 mm, (ϕ x L) 1.21 x 5.1 mm</p>

HCV Cartridges for High Thermal Demand applications with increased heating elements are compatible with MX-5000, MX-5200 and CV-5200 Systems
MX-H6-HTD, CV-H6-HTD, CV-H7-HTD Solder Hand pieces.

HTC Cartridges for High Thermal Demand applications are compatible with MX-5000 and MX-5200 Systems – MX-H6-HTD Solder Hand pieces.



Temperature	CV-Series	MX-Series	Application
775 °F/413 °C	HCV-7	HTC-7	Most Standard Ceramic and High Thermal Demand
875 °F/468 °C	HCV-8	HTC-8	
950 °F/510 °C	HCV-9	HTC-9	

Please note the above temperatures are the maximum temperatures of the heater. The idle temperature is dependent on the geometry of the cartridge.

For High Mass Applications			
	HCV-7CN0020S HCV-8CN0020S HCV-9CN0020S	HTC-7CN0020S HTC-8CN0020S HTC-9CN0020S	Conical, (ø x L) 2 x 8.3 mm
	HCV-7CH0015S HCV-8CH0015S HCV-8CH0015S	N/A	Chisel, (W x L) 1.47 x 10.4 mm
	HCV-7CH0018S HCV-8CH0018S HCV-9CH0018S	N/A	Chisel, (W x L) 1.85 x 10 mm
	HCV-7CH0025S HCV-8CH0025S HCV-9CH0025S	HTC-7CH0025S HTC-8CH0025S HTC-9CH0025S	Chisel, (W x L) 2.5 x 8 mm

For High Mass Applications

	HCV-7CH0053S	HTC-7CH0053S	Chisel, (W x L) 5.3 x 8.3 mm
	HCV-8CH0053S	HTC-8CH0053S	
	HCV-9CH0053S	HTC-9CH0053S	
	HCV-7VG0053S	HTC-7VG0053S	V-Groove Chisel for pin soldering, Grove (W x L) 1.0 x 4 mm, (W x L) 5.3 x 8.3 mm
	HCV-8VG0053S	HTC-8VG0053S	
	HCV-9VG0053S	HTC-9VG0053S	

PTC Tweezer Cartridges are compatible with MX-500, MX-5000, MX-5200 and CV-5200, CV-500 Systems, MX-PTZ and CV-H4-PTZ Tweezer Hand pieces.

PTTC Tweezer-Cartridges are compatible with MX-500, MX-5000, MX-5200 and CV-5200, CV-500 Systems – MX-PTZ and CV-H4-PTZ Tweezer Hand pieces.



Temperature	CV-Series	MX-Series	Application
675 °F/357 °C	PTC-6	PTTC-6	Temperature Sensitive
775 °F/413 °C	PTC-7	PTTC-7	Most Standard
875 °F/468 °C	PTC-8		Ceramic and High Thermal Demand
950 °F/510 °C	PTC-9	PTTC-8	

Please note the above temperatures are the maximum temperatures of the heater. The idle temperature is dependent on the geometry of the cartridge.

These tips will provide data via the CV power supplies, but due to the nature of their application the Connection Validation function is not required and therefore not enabled. - All tweezer cartridges are sold per pair!

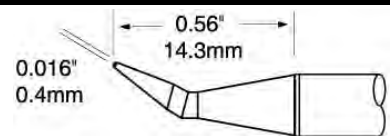
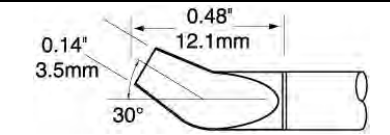
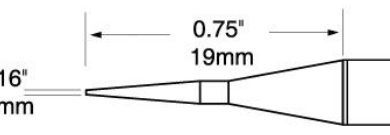
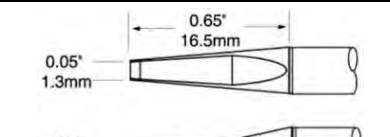
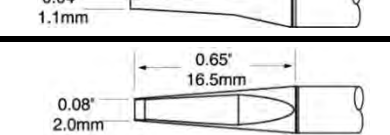
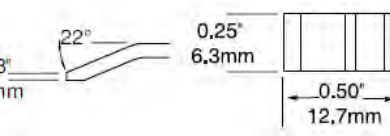
Rework Tweezer Cartridges - Bent			
	PTC-6CN1404A PTC-7CN1404A PTC-8CN1404A PTC-9CN1404A	PTTC-601B PTTC-701B --- PTTC-801B	Conical, 30° bent, for work under a microscope, (Ø x L) 0.4 x 14.3 mm Sold per pair
	PTC-6FB1235R PTC-7FB1235R PTC-8FB1235R PTC-9FB1235R	PTTC-608B PTTC-708B --- PTTC-808B	Blade, 30° bent, for work under a microscope, (W x L) 3.2 x 12.1 mm, Sold per pair
Rework Tweezer Cartridges - Conical			
	PTC-6CN2304A PTC-7CN2304A PTC-8CN2304A PTC-9CN2304A	PTTC-601 PTTC-701 --- PTTC-801	Conical, (Ø x L) 0.4 x 19 mm, Sold per pair
Rework Tweezer Cartridges - Blade			
	PTC-6CH1713A PTC-7CH1713A PTC-8CH1713A PTC-9CH1713A	PTTC-602 PTTC-702 --- PTTC-802	Blade, (W x L) 1.3 x 16.5 mm, Sold per pair
	PTC-6CH1720A PTC-7CH1720A PTC-8CH1720A PTC-9CH1720A	PTTC-603 PTTC-703 --- PTTC-803	Blade, (W x L) 2.0 x 16.5 mm, Sold per pair
	PTC-6BL1306R PTC-7BL1306R PTC-8BL1306R PTC-9BL1306R	PTTC-604 PTTC-704 --- PTTC-804	Blade, (W x L) 6.35 x 12.7 mm, Sold per pair

Rework Tweezer Cartridges - Blade

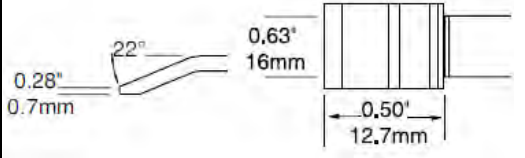
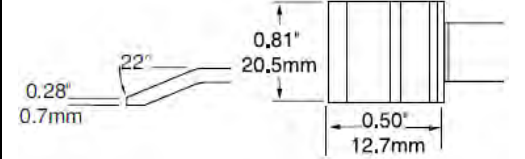
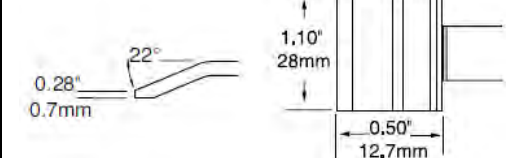
 <p>0.28" 0.7mm</p> <p>22°</p> <p>0.63" 16mm</p> <p>0.50" 12.7mm</p>	<p>PTC-6BL1316R</p> <p>PTC-7BL1316R</p> <p>PTC-8BL1316R</p> <p>PTC-9BL1316R</p>	<p>PTTC-605</p> <p>PTTC-705</p> <p>---</p> <p>PTTC-805</p>	<p>Blade, (W x L) 15.75 x 12.7 mm, Sold per pair</p>
 <p>0.28" 0.7mm</p> <p>22°</p> <p>0.81" 20.5mm</p> <p>0.50" 12.7mm</p>	<p>PTC-6BL1321R</p> <p>PTC-7BL1321R</p> <p>PTC-8BL1321R</p> <p>PTC-9BL1321R</p>	<p>PTTC-606</p> <p>PTTC-706</p> <p>---</p> <p>PTTC-806</p>	<p>Blade, (W x L) 20.6 x 12.7 mm, Sold per pair</p>
 <p>0.28" 0.7mm</p> <p>22°</p> <p>1.10" 28mm</p> <p>0.50" 12.7mm</p>	<p>PTC-6BL1328R</p> <p>PTC-7BL1328R</p> <p>PTC-8BL1328R</p> <p>PTC-9BL1328R</p>	<p>PTTC-607</p> <p>PTTC-707</p> <p>---</p> <p>PTTC-807</p>	<p>Blade, (W x L) 28 x 12.7 mm, Sold per pair</p>

UFT Ultra-Fine Tweezer Cartridges are compatible with CV-5200, CV-500 Systems and CV-H4-UFT Ultrafine Tweezer Hand piece.



Temperature	CV-Series	Application
675 °F/357 °C	UFT-6	Temperature Sensitive
775 °F/413 °C	UFT-7	Most Standard

Please note the above temperatures are the maximum temperatures of the heater. The idle temperature is dependent on the geometry of the cartridge.

These tips will provide data via the CV power supplies, but due to the nature of their application the Connection Validation function is not required and therefore not enabled. All tweezer cartridges are sold per pair!

Ultra-Fine Tweezer Cartridge - Chisel

	<p>UFT-6CH9006S</p> <p>UFT-7CH9006S</p>	<p>(W x L) 0.6 x 9 mm</p> <p>Sold per pair</p>
	<p>UFT-6CH9008S</p> <p>UFT-7CH9008S</p>	<p>(W x L) 0.8 x 9 mm</p> <p>Sold per pair</p>

Ultra-Fine Tweezer Cartridge - Conical

	<p>UFT-6CN5502R</p> <p>UFT-7CN5502R</p>	<p>Conical, Bent, for work under a microscope,</p> <p>(ϕ x L) 0.2 x 5.6 mm,</p> <p>Sold per pair</p>
	<p>UFT-6CN5504R</p> <p>UFT-7CN5504R</p>	<p>Conical, Bent, for work under a microscope,</p> <p>(ϕ x L) 0.4 x 5.6 mm,</p> <p>Sold per pair</p>
	<p>UFT-6CN8004S</p> <p>UFT-7CN8004S</p>	<p>Conical</p> <p>(ϕ x L) 0.4 x 8.7 mm,</p> <p>Sold per pair</p>

Ultra-Fine Tweezer Cartridge - Power Wedge

	<p>UFT-6PW3150S</p> <p>UFT-7PW3150S</p>	<p>Power Wedge, two-way use, tip and long side,</p> <p>(ϕ x L) 0.31 x 5.0 mm,</p> <p>Sold per pair</p>
	<p>UFT-6PW2954C</p> <p>UFT-7PW2954C</p>	<p>Power Wedge, two-way use, tip and long side,</p> <p>(ϕ x L) 0.29 x 5.4 mm,</p> <p>Sold per pair</p>

DSC De-Solder Cartridges are compatible with MX-500, MX-5000, MX-5200 AND CV-5200, CV-500 Systems – MX-DS1 and CV-H5-DS Hand pieces.

STDC De-Solder Cartridges are compatible with MX-500, MX-5000, MX-5200 Systems and MX-DS1 Hand piece.



Temperature	CV-Series	MX-Series	Application
675 °F/357 °C	DSC-6	STDC-0	Temperature Sensitive
775 °F/413 °C	DSC-7	STDC-1 / 7xxL	Most Standard
875 °F/468 °C	DSC-8		Ceramic and High Thermal Demand
950 °F/510 °C	DSC-9	STDC-8	

Please note the above temperatures are the maximum temperatures of the heater. The idle temperature is dependent on the geometry of the cartridge.

These tips will provide data via the CV series power supplies, but due to the nature of their application the Connection Validation function is not required and therefore not enabled.

De-Solder Cartridges		A	B	C	
<p>Standard</p>	DSC-6CN0006S	STDC-002	0.64 mm	1.40 mm	11.43 mm
	DSC-7CN0006S	STDC-102			
	DSC-8CN0006S	STDC-802			
	DSC-9CN0006S	STDC-802	0.76 mm	1.68 mm	11.17 mm
	DSC-6CN0008S	STDC-003			
	DSC-7CN0008S	STDC-103			
	DSC-8CN0008S	STDC-803	1.02 mm	1.78 mm	10.92 mm
	DSC-9CN0008S	STDC-803			
	DSC-6CN0010S	STDC-004			
	DSC-7CN0010S	STDC-104	1.27 mm	2.03 mm	10.66 mm
	DSC-8CN0010S	STDC-804			
	DSC-9CN0010S	STDC-804			
DSC-6CN0013S	STDC-005	1.52 mm	2.29 mm	10.41 mm	
DSC-7CN0013S	STDC-105				
DSC-8CN0013S	STDC-805				
DSC-9CN0013S	STDC-805	2.41 mm	3.18 mm	9.14 mm	
DSC-6CN0015S	STDC-006				
DSC-7CN0015S	STDC-106				
DSC-8CN0015S	STDC-806	0.76 mm	1.68 mm	21.33 mm	
DSC-9CN0015S	STDC-806				
DSC-6CN0024S	STDC-007				
DSC-7CN0024S	STDC-107	1.02 mm	1.79 mm	21.08 mm	
DSC-8CN0024S	STDC-807				
DSC-9CN0024S	STDC-807				
DSC-6CN0008A	STDC-703L	1.02 mm	1.79 mm	21.08 mm	
DSC-7CN0008A	STDC-704L				
DSC-8CN0008A	STDC-803L				
DSC-9CN0008A	STDC-803L	1.27 mm	2.03 mm	20.82 mm	
DSC-6CN0010A	STDC-704L				
DSC-7CN0010A	STDC-705L				
DSC-8CN0010A	STDC-804L	1.27 mm	2.03 mm	20.82 mm	
DSC-9CN0010A	STDC-804L				
DSC-6CN0013A	STDC-705L				
DSC-7CN0013A	STDC-705L	1.27 mm	2.03 mm	20.82 mm	
DSC-8CN0013A	STDC-805L				
DSC-9CN0013A	STDC-805L				

DSC-xxxA / STDC-xxxL = Long Reach Desolder Cartridge to remove components form high density packed PCBs.

Since 1982, Metcal has been a recognized worldwide leader in the electronics assembly marketplace. As part of OK International, Metcal's industry-leading position addressing advanced technology in conduction soldering and rework has and will continue to broaden to a full electronics bench tool single-source solution. Metcal product lines currently include: hand soldering and desoldering, convection rework, fume extraction and fluid dispensing tools.

Corporate Headquarters (United States)

OK International/ Metcal Headquarters

10800 Valley View Street
Cypress, CA 90630
Tel: 714-799-9910
Fax: 714-828-2001
Email: na-custcare@okinternational.com

European Corporate Office

OK International/ Metcal

Eagle Close, Chandler's Ford
Hampshire, SO53 4NF, United Kingdom
Tel: English +44 2380 489 100
Tel: Français: +33 176 710 403
Tel: Deutsch: +49 711 959 69744
Email: europe@okinternational.com

China Corporate Office

OK International/ Metcal

4th floor East, The Electronic Building
Yanxiang Industrial Zone
High Tech Road, Guangming New District
Shenzhen, P.R.C
Tel: +86-755-2327 6366
Fax: +86-755-2329 5492
Email: china@okinternational.com



METCAL™

www.metcal.com

X-ON Electronics

Largest Supplier of Electrical and Electronic Components

Click to view similar products for [Soldering Irons](#) category:

Click to view products by [Metcal](#) manufacturer:

Other Similar products are found below :

[0058759725](#) [918100-TE](#) [PTTC-802](#) [SFV-DRK30AR](#) [SMTC-0167](#) [SMTC-588](#) [AC-CK1](#) [AC-CK2](#) [SSC-601A](#) [SSC-625A](#) [SSC-638A](#) [SSC-726A](#) [FG-BVX](#) [STTC-042](#) [STTC-065](#) [STTC-838P](#) [STV-CH24A](#) [STV-DRK45A](#) [PTTC-805](#) [UFTC-6CN04](#) [SFP-DRH05](#) [SMTC-061](#) [SMTC-101](#) [SMTC-1162](#) [SMTC-160-PK](#) [SMTC-1BL250](#) [SMTC-862](#) [SSC-645A](#) [SSC-671A](#) [SSC-672A](#) [SSC-713A](#) [SSC-742A](#) [SSC-745A](#) [SSC-746A](#) [SSC-770A](#) [SSC-772A](#) [STDC-804](#) [STTC-105](#) [STTC-120](#) [STTC-545](#) [1-91362-0](#) [T0054487399](#) [T0054472199](#) [STTC-820](#) [MFR-UK5](#) [MX-H1GKG](#) [SCV-CH30AR](#) [T0054487099](#) [STTC-845P](#) [RPS-1](#)