



## INSTRUMET 19" CASES

[Home Page](#)
[E-Mail Us](#)
[Catalogue PDF](#)
[Get a Catalogue](#)
[Get a Drawing](#)
[Get a Price](#)
[Get a Quote](#)
[Customising](#)
[IP Ratings](#)
[Colour Chart](#)
[Ordering Info](#)
 **01489 583858**
 **01489 583836**

### FEATURES:

- Modern aluminium 19" instrument cases
- Light weight yet robust construction
- Conforms to DIN 41494 & IEC 297-1
- Designed to accept standard 3U x 19" subracks, chassis and front panels
- Attractive design with die-cast front and rear bezels and fabricated case body
- Two versions, in three sizes
- Standard models with ABS side handles
- Portable models with tilt/swivel aluminium carry handle bar
- Supplied fully assembled and ready to use
- Internal subrack/chassis support rails
- Removable rear panel included
- Ventilation holes in base and rear panels
- Three M4 earth studs provided inside
- Moulded ABS non-slip tilt feet included
- Anodised 10.5"/19" front panels available as accessories

### MATERIAL:

- Aluminium

### PROTECTION CLASS:

- < IP 40 (Not rated)

### STANDARD COLOUR:

- Front bezel - window grey, RAL 7040
- Case body - light grey, RAL 7035 (powder polyester paint)

### SUPPLY:

1. Front/rear bezel (x2)
2. Top cover
3. Base panel
4. Rear panel
5. Chassis support
6. ABS Side handle
7. Aluminium carry handle
8. ABS tilt feet
9. M4 x 10 mm (x8)  
M4 x 12 mm (x4)
10. M3 x 8 mm (x12)

### ACCESSORIES:

- 10.5"/19" Front Panel
- 19" Subrack/ Front Panel Mounting Kit

### APPLICATIONS:

- 19" subrack or chassis based electronics such as test and measurement equipment, networking and communications devices, industrial computers, sound and studio systems, laboratory instruments and industrial control systems.

 [Printable Page](#)

Modern 19" Instrument Cases



Subrack Mounting



Carry Handle Bar





ABS Tilt Feet

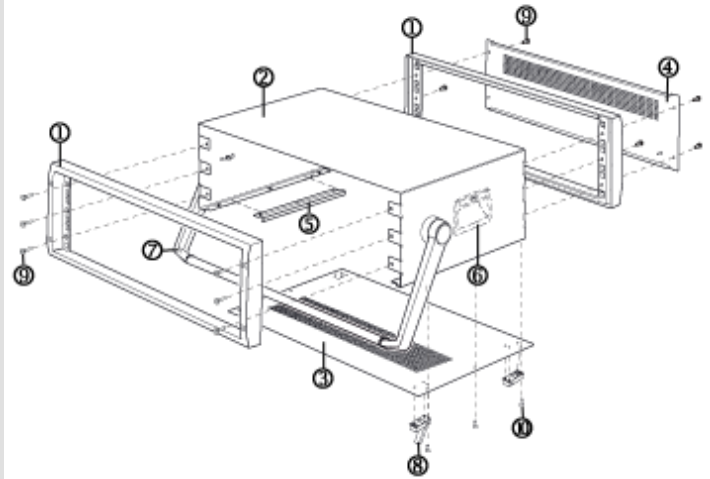

Accessory Front Panels



### INSTRUMET 10.5" CASES

							
Part No. Standard Model	Part No. Portable Model	Type	H	W	D	Drawings	
M6010305		3U x 10.5"	157	303	350	<a href="#">PDF</a>	<a href="#">DWG</a>
	M6010315	3U x 10.5"	157	303	350	<a href="#">PDF</a>	<a href="#">DWG</a>

### INSTRUMET 19" CASES

							
Part No. Standard Model	Part No. Portable Model	Type	H	W	D	Drawings	
M6019305		3U x 19"	157	516	350	<a href="#">PDF</a>	<a href="#">DWG</a>
	M6019315	3U x 19"	157	516	350	<a href="#">PDF</a>	<a href="#">DWG</a>
M6019325		3U x 19"	157	516	450	<a href="#">PDF</a>	<a href="#">DWG</a>
	M6019335	3U x 19"	157	516	450	<a href="#">PDF</a>	<a href="#">DWG</a>

### ACCESSORIES



For case..	Part No. Aluminium Front Panel		Part No. Subrack/Front Panel Mtg Kit*		Drawings	
3U x 10.5"	M6010001	£			PDF	DWG
3U x 19"	M6019001	£			PDF	DWG
All			M6000035	£		

**Notes:**  
 \* Front Panel Kit - Anodised front panel  
 \* 19" Subrack/Front Panel Mounting Kit - 4 M6 caged nuts, 4 M6 Screws & 4 ABS plastic washers (RAL 7035)

 [Printable Page](#)



[Customising](#)

Tel: (01489) 583858 Last Updated: 27-Feb-2008 ©OKW Enclosures Ltd. UK. All rights reserved.

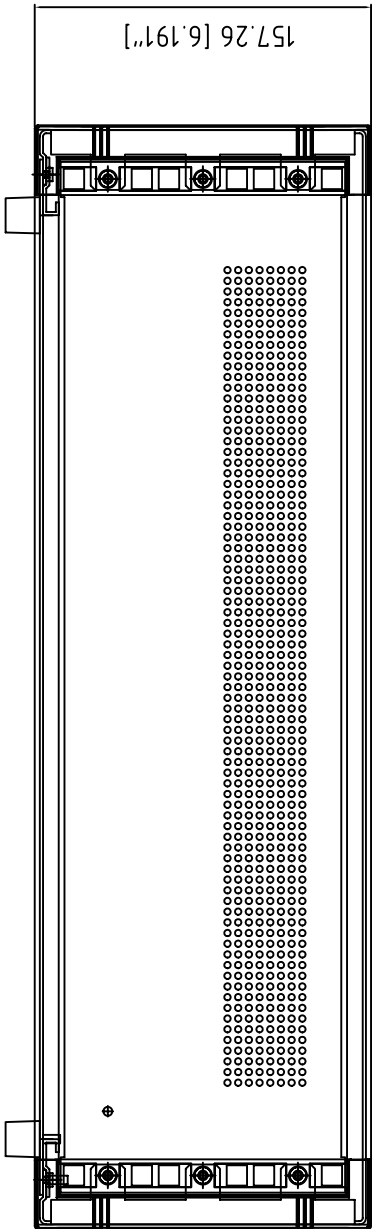
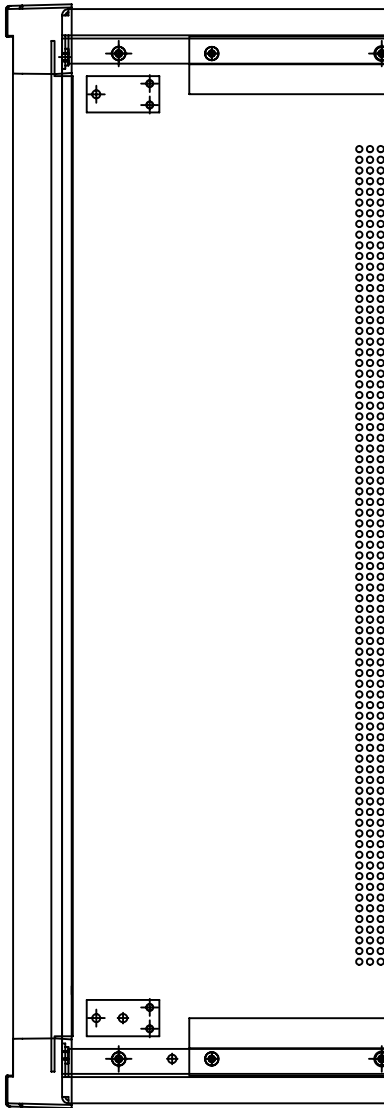

157.26 [6.191"]

Tolerances unless otherwise stated:

- Linear tolerances ±0.20
- Radius tolerances between 0.15 and 0.25
- Distances on hole diameters ±0.05
- Angles ± 0.5°
- Surface finish 32/

Required Finish:

See notes

Scale: 1:1

ALL DIMENSIONS IN MILLIMETRES

DO NOT SCALE

Drawn By:  
Ian Cox

Checked By:

Drawing Number

--

Date drawn:

Nov '07

Material Spec.



METCASE ENCLOSURES  
15 Brunel Way  
Segensworth East, Fareham,  
Hampshire, PO15 5TX, UK.

www.metcase.com

Part Name

Instrument 3U x 19" x 350mm - Side Handles

Part Number

M6019305

Sheet 1 of 1

OKW ENCLOSURES LTD. (DATE AS SHOWN). THIS DRAWING CONTAINS PROPRIETARY INFORMATION OF OKW ENCLOSURES LTD. AND IS TENDERED SUBJECT TO THE FOLLOWING CONDITIONS: THE INFORMATION BE RETAINED IN CONFIDENCE, NOT BE REPRODUCED OR COPIED, AND NOT BE USED OR INCORPORATED IN ANY PRODUCT, UNLESS PERMISSION IS OBTAINED IN WRITING FROM OKW ENCLOSURES LTD.

A2

## **X-ON Electronics**

Largest Supplier of Electrical and Electronic Components

*Click to view similar products for [metcase](#) manufacturer:*

Other Similar products are found below :

[M5501110](#) [M5623105F](#) [M5513110](#) [M5625305F](#) [M5725207](#) [M6019305](#) [M5506110](#) [M5700615](#) [M5700621](#) [M5505119](#)