

# 45 SERIES

## GENERAL PURPOSE ▲ Si MOSFET RELAY

**SILICON Si MOSFET RELAY ▲** DIP and SMD type  
 Switches AC or DC load  
 One channel and two channel packages available  
 Input TTL / CMOS compatible  
 Moisture Sensitivity Level ▲ MSL 1  
**UL 1577 approved ▲ File no E344988**

### SPECIFICATION

Item	Characteristics	
Contact Form	1 Form A / 2 Form A ▲ Normally open switch	
Load Voltage	$V_L$	60V
Operation LED Current	$I_{F ON}$	3mA
Load Current	$I_L$	200mA
On-Resistance	$R_{ON}$	3Ω
Output Capacitance	$C_{OUT}$	20pF
Low Off-State Leakage Current	$I_{LEAK}$	1μA at 60V <sub>DC</sub>

### APPLICATIONS

Automatic Test Equipment	Electric Mobility	I/O Modules	Industrial Automation	Measurement Equipment	Security Equipment	Sensing Equipment

### DIMENSIONS

Package	Illustration	Dimensions	PCB Board Pattern
DIP-4		<p>                     4.7 ±0.3                      1.2 ±0.2                      6.4 ±0.3                      2.54 ±0.1                      0.5 ±0.1                      3.4 ±0.2                      3.0 ±0.2                      7.87                      0.25 ±0.01                      9.54 max.                 </p>	<p>                     4-φ0.8                      2.54                      7.62                      BOTTOM VIEW                 </p>
SMD-4		<p>                     4.7 ±0.3                      1.2 ±0.2                      6.4 ±0.3                      2.54 ±0.1                      0.5 ±0.1                      3.4 ±0.2                      0.1 ±0.05                      15° max.                      1.3 ±0.4                      1.3 ±0.4                      10 ±0.3                      0.25 ±0.1                 </p>	<p>                     8.7                      1.9                      1.5                      2.54                      TOP VIEW                 </p>

## DIMENSIONS

Package	Illustration	Dimensions	PCB Board Pattern
DIP-6			<p><b>BOTTOM VIEW</b></p>
SMD-6			<p><b>TOP VIEW</b></p>
DIP-8			<p><b>BOTTOM VIEW</b></p>
SMD-8			<p><b>TOP VIEW</b></p>
SOP-4			<p><b>TOP VIEW</b></p>
SOP-8			<p><b>TOP VIEW</b></p>

**ABSOLUTE MAXIMUM RATINGS ▲ AMBIENT TEMPERATURE  $T_A = 25^\circ\text{C}$** 

Type	Item	Condition	Symbol	Value					Unit
				SOP-4	SOP-8	DIP-4 SMD-4	DIP-8 SMD-8	DIP-6 SMD-6	
Type	Outline package			SOP-4	SOP-8	DIP-4 SMD-4	DIP-8 SMD-8	DIP-6 SMD-6	
	Part number			AB45S	AC45S	AB45(F)	AC45(F)	AA45(F)	
	Output channels			1	2	1	2	1	Channels
Input	Continuous LED Current		$I_F$	50					mA
	Peak LED Current	100 Hz, Duty 1%	$I_{FP}$	500					mA
	LED Reverse Voltage		$V_R$	5					V
	Input Power Dissipation		$P_{IN}$	75					mW
Output	Load Voltage		$V_L$	60 (AC peak or DC)					V
	Load Current		$I_L$	200	200	200	200	200	mA
	Peak Load Current	1 ms, 1 shot	$I_{PEAK}$	600	600	600	600	600	mA
	Output Power Dissipation		$P_{OUT}$	300	450	450	600	450	mW
Relay	Total Power Dissipation		$P_T$	350	500	500	650	500	mW
	I/O Breakdown Voltage		$V_{I/O}$	1500	1500	3750	3750	3750	$V_{RMS}$
	I/O Breakdown Voltage (Suffix-H)		$V_{I/O}$	3750	3750	5000	5000	5000	$V_{RMS}$
	Operating Temperature Range		$T_{OPR}$	-40 to +85					$^\circ\text{C}$
	Storage Temperature Range		$T_{STG}$	-40 to +100					$^\circ\text{C}$

**ELECTRICAL CHARACTERISTICS ▲ AMBIENT TEMPERATURE  $T_A = 25^\circ\text{C}$** 

	Item	Condition	Symbol	Min.	Typ.	Max.	Unit
Input	LED Forward Voltage	$I_F = 10\text{mA}$	$V_F$	1	1.17	1.5	V
	Operation LED Current		$I_{FON}$		0.9	3	mA
	Recovery LED Voltage		$V_{FOFF}$	0.5	1		V
Output	On-Resistance Drain to Drain (tested within 1 sec.)	$I_F=5\text{mA}, I_L=\text{Rating}$	$R_{ON}$		3	14	$\Omega$
	Off-State Leakage Current	$V_L = 60\text{V}$	$I_{LEAK}$			1	$\mu\text{A}$
	Output Capacitance	$V_L=0\text{V}, f=1\text{MHz}$	$C_{OUT}$		20		pF
Transmission	Turn-On Time (for SOP type)	$I_F=5\text{mA}, I_L=\text{Rating}$	$t_{ON}$		0.1	1	ms
	Turn-Off Time (for SOP type)	$I_F=5\text{mA}, I_L=\text{Rating}$	$t_{OFF}$		0.03	0.5	ms
	Turn-On Time (for DIP/SMD type)	$I_F=10\text{mA}, I_L=\text{Rating}$	$t_{ON}$		0.07	1	ms
	Turn-Off Time (for DIP/SMD type)	$I_F=10\text{mA}, I_L=\text{Rating}$	$t_{OFF}$		0.03	0.5	ms
Coupled	I/O Insulation Resistance		$R_{I/O}$	$10^9$			$\Omega$
	I/O Capacitance	$f=1\text{MHz}$	$C_{I/O}$		1.3		pF

REFERENCE DATA

Load current vs. ambient temp.

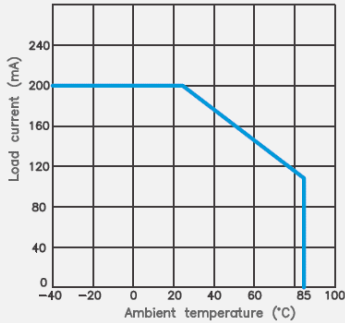

On resistance vs. ambient temp.

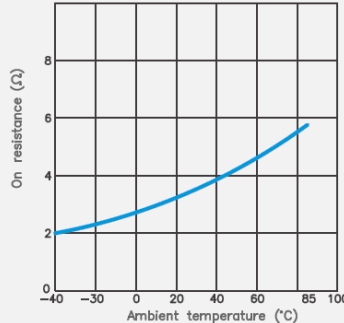

Turn on time vs. ambient temp.

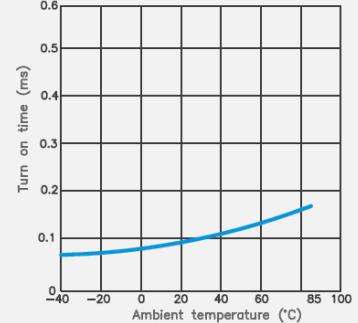

Turn off time vs. ambient temp.

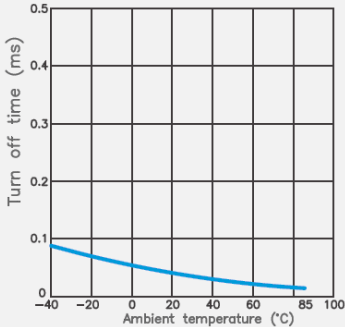

LED operate current vs. ambient temp

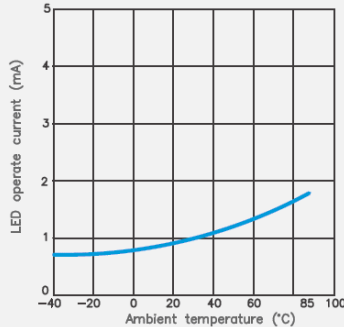

LED turn off current vs. ambient temp.

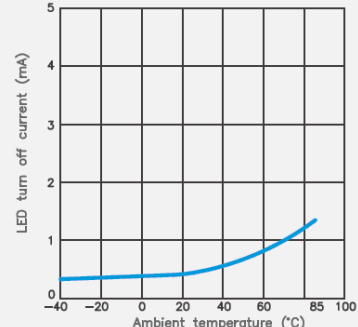

LED forward voltage vs. ambient temp.

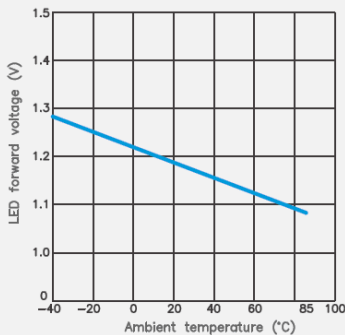

Current vs. voltage characteristics of output at MOS portion

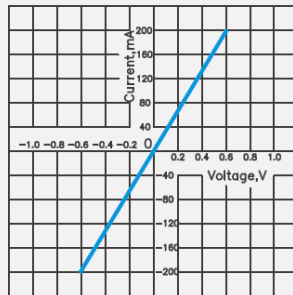

Off state leakage current vs. load voltage

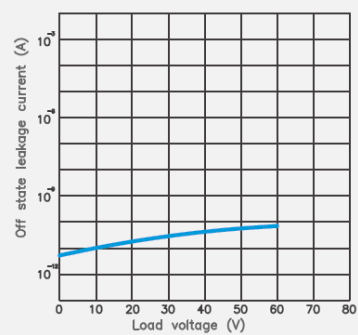

Turn on time vs. LED forward current

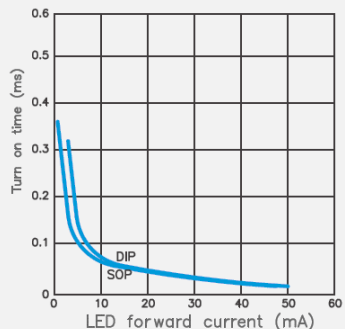

Turn off time vs. LED forward current

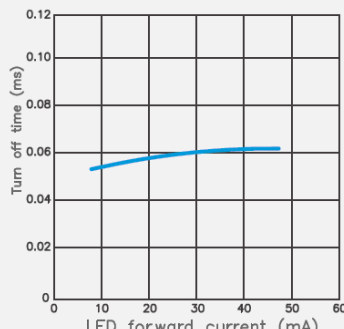

Output capacitance vs. applied voltage

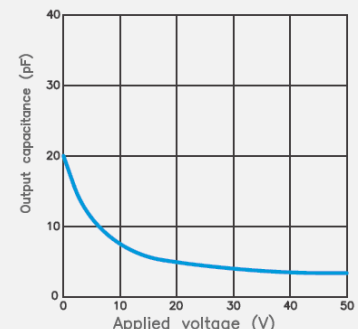

**PIN DESCRIPTION AND PART NUMBER**

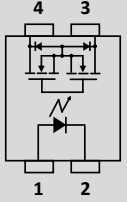
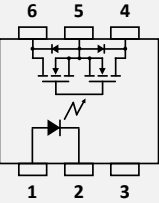
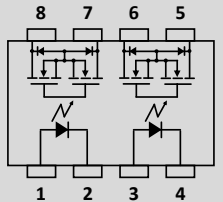
Circuit Diagram	Pin Description	Part No.	Package	Packing
	1 Anode (+) ▪ LED 2 Cathode (-) ▪ LED 3,4 Drain ▪ MOSFET	AB45 AB45F AB45S AB45F-R1 AB45S-R1	DIP-4 SMD-4 SOP-4 SMD-4 SOP-4	Tube (90pcs) Tube (90pcs) Tube (100pcs) Reel (1 000pcs) Reel (1 000pcs)
	1 Anode (+) ▪ LED 2 Cathode (-) ▪ LED 3 NC 4,6 Drain ▪ MOSFET 5 Source ▪ MOSFET	AA45 AA45F AA45F-R1	DIP-6 SMD-6 SMD-6	Tube (50pcs) Tube (50pcs) Reel (1 000pcs)
	1,3 Anode (+) ▪ LED 2,4 Cathode (-) ▪ LED 5,6,7,8 Drain ▪ MOSFET	AC45 AC45F AC45S AC45F-R1 AC45S-R1	DIP-8 SMD-8 SOP-8 SMD-8 SOP-8	Tube (45pcs) Tube (45pcs) Tube (50pcs) Reel (1 000pcs) Reel (1 000pcs)

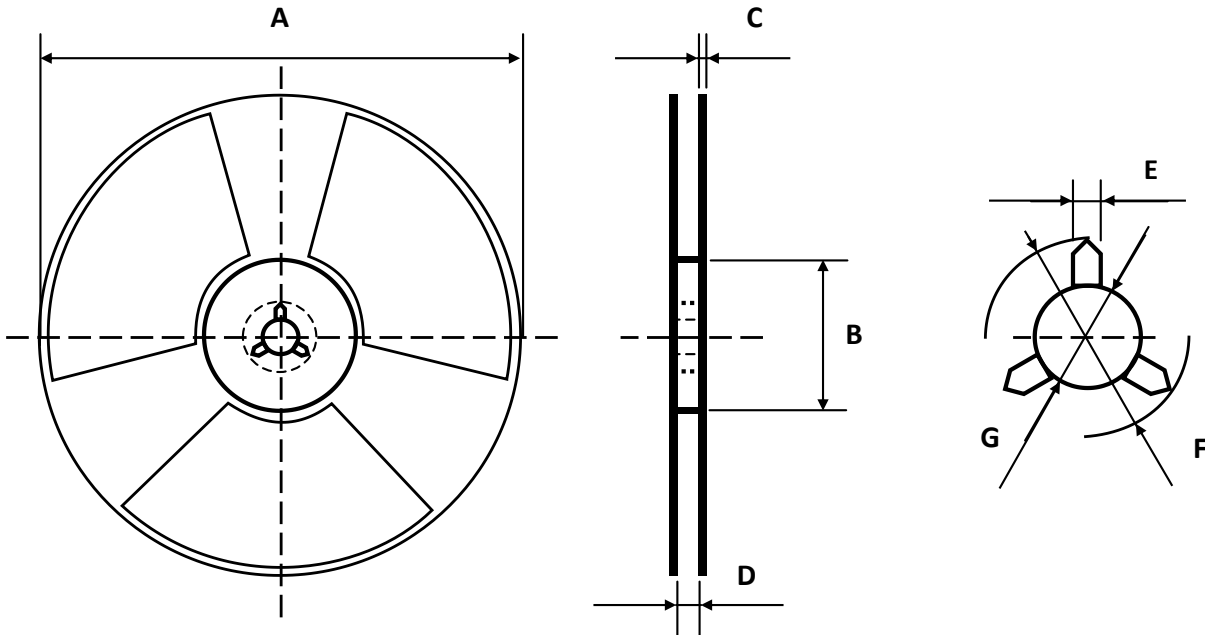
**REEL DIMENSIONS ▲ All dimensions in mm**

Size	A	B	C	D	E	F	G
SOP-4	330	100	2	13	2	13	21
SOP-8	330	100	2	17	2	13	21
SMD-4	380	80	2.2	17	2	13	21
SMD-6	380	80	2.2	17	2	13	21
SMD-8	380	80	2.2	17	2	13	21

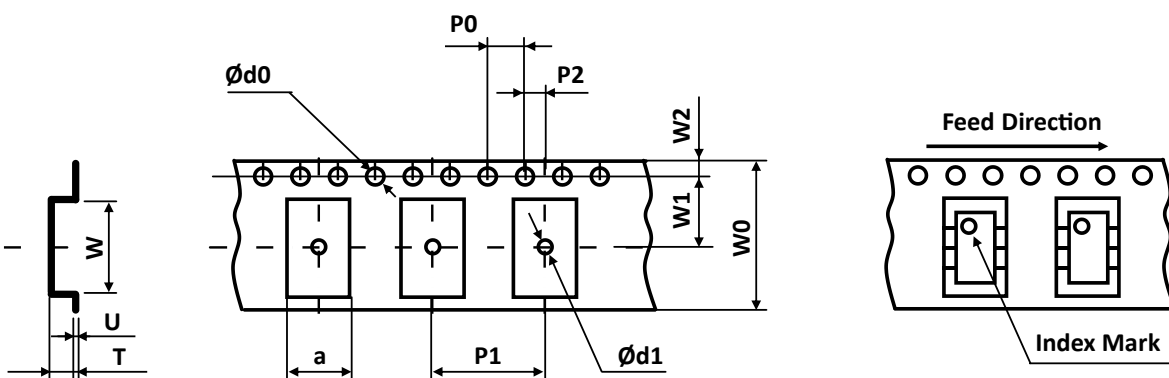
**TAPE DIMENSIONS ▲ All dimensions in mm**

Size	W	U	T	a	$\phi d0$	$\phi d1$	P0	P1	P2	W0	W1	W2
SOP-4	4.6	0.3	2.3	7.2	1.5	1.5	4	12	2	12	7.5	1.75
SOP-8	10.4	0.3	2.3	7.5	1.5	1.5	4	12	2	16	7.5	1.75
SMD-4	5.3	0.3	4	10.6	1.5	1.5	4	16	2	16	7.5	1.75
SMD-6	9.15	0.3	4.45	10.4	1.5	1.5	4	16	2	16	11.5	1.75
SMD-8	9.9	0.3	4	10.6	1.5	1.5	4	16	2	16	7.5	1.75

Tape and Reel Packing	PCS/Reel
SMD-4	1000
SMD-6	1000
SMD-8	1000
SOP-4	1000
SOP-8	1000

Tube Packing	PCS/Tube	Tubes/Box	Units/Box
DIP-4	90	30	2700
DIP-6	50	30	1500
DIP-8	45	30	1350
SMD-4	90	30	2700
SMD-6	50	30	1500
SMD-8	45	30	1350
SOP-4	100	30	3000
SOP-8	50	30	1500

## STORAGE AND HANDLING CONDITIONS

ESD level	Floor life	Conditions	MSL
HBM class 2	Unlimited	$T_A < 30^{\circ}\text{C}$ , $\text{RH} < 85\%$	1

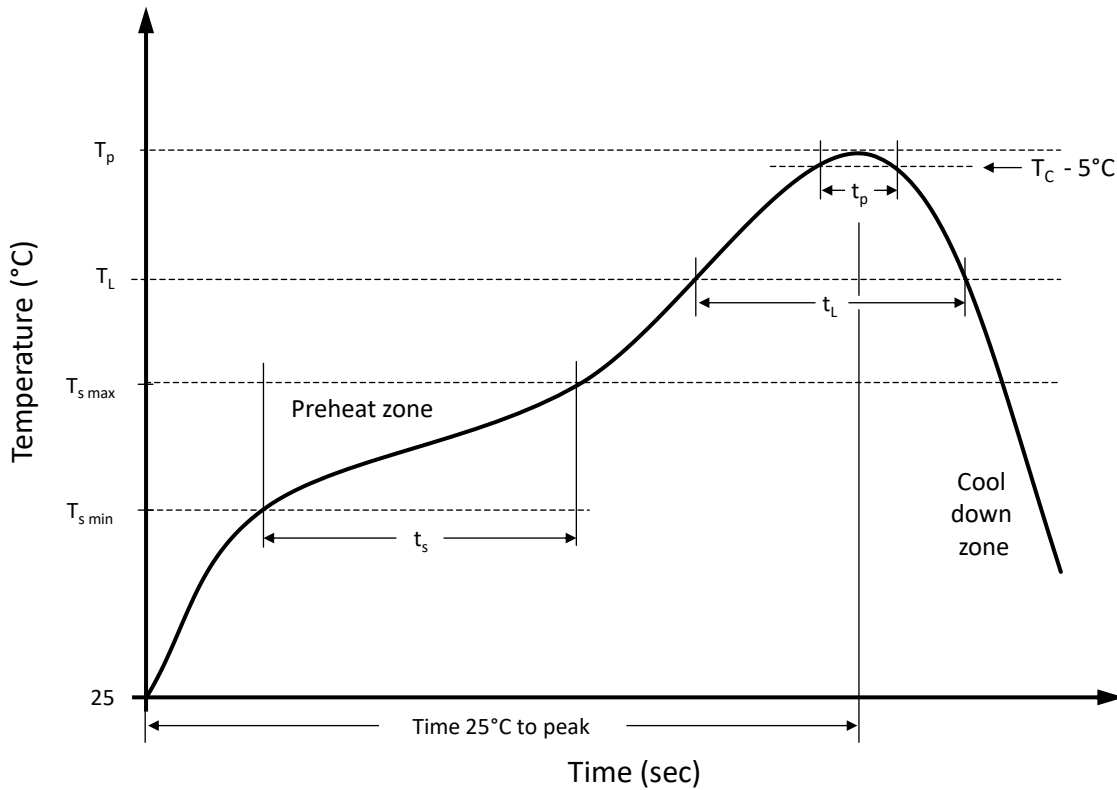
**RECOMMENDED REFLOW SOLDERING PROFILE ▲ SMD PACKAGE**

**Recommended reflow soldering conditions ▲ Refer to JEDEC J-STD-020E**

Profile Features		Sn-Pb Eutetic Assembly	Pb-Free Assembly
Preheat temperature min.	$T_{s\ min}$	100 °C	150 °C
Preheat temperature max.	$T_{s\ max}$	150 °C	200 °C
Preheat time $t_s$ from $T_{s\ min}$ to $T_{s\ max}$	$t_s$	120 seconds	120 seconds
Ramp-up rate ( $T_L$ to $T_p$ )		max. 3 °C/second	max. 3 °C/second
Liquidous temperature	$T_L$	183 °C	217 °C
Time $t_L$ maintained above $T_L$	$t_L$	150 seconds max.	60 seconds max.
Peak package body temperature	$T_p$	235°C	260°C
Timeframe of within 5°C below and up to max actual peak body temperature	$t_p$	20 seconds max.	30 seconds max.
Ramp-down rate ( $T_L$ to $T_p$ )		max. 6 °C/second	max. 6 °C/second
Time 25°C to peak temperature		max. 6 minutes	max. 8 minutes

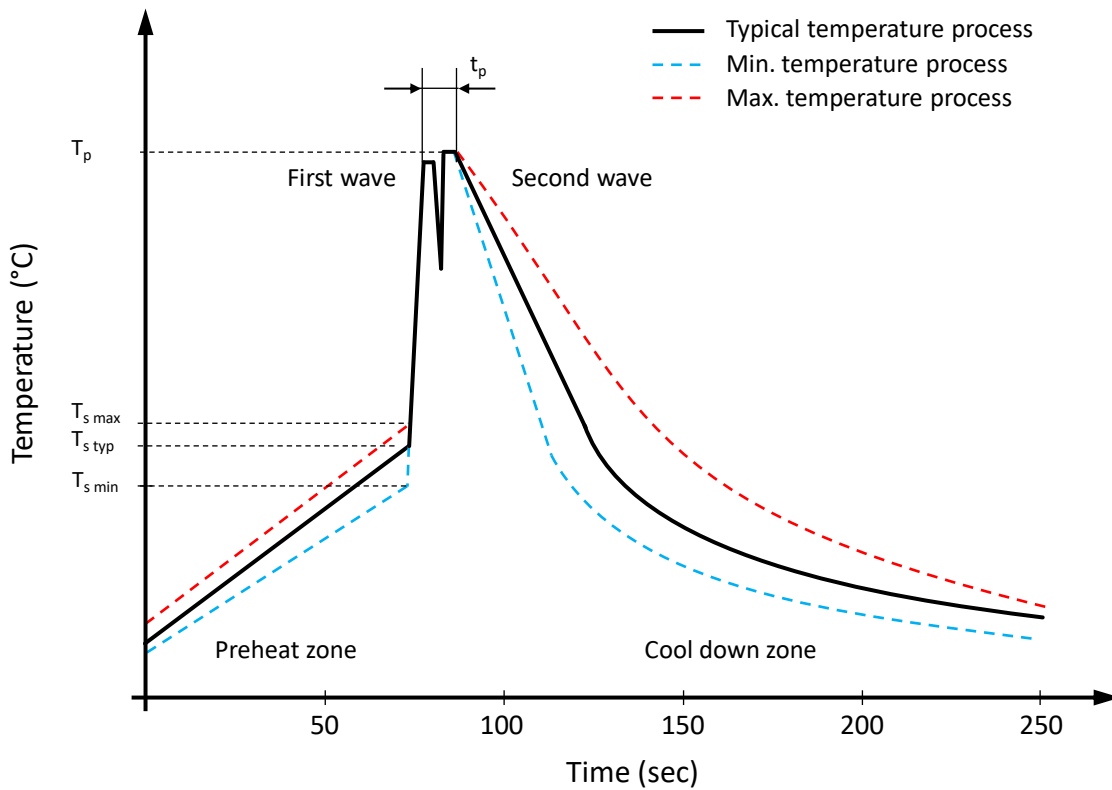

**RECOMMENDED WAVE SOLDERING PROFILE ▲ THT PACKAGE**

**Classification wave soldering profile ▲ Refer to EN 61760-1: 2006**

Profile Features		Value ▲ Sn-Pb Assembly	Value ▲ Pb-free Assembly
Preheat temperature min.	$T_{s\ min}$	100 °C	100 °C
Preheat temperature typical	$T_{s\ typ}$	120 °C	120 °C
Preheat temperature max.	$T_{s\ max}$	130 °C	130 °C
Preheat time $t_s$ from $T_{s\ min}$ to $T_{s\ max}$	$t_s$	70 seconds	70 seconds
Peak temperature	$T_p$	235 °C to 260 °C	245 °C to 260 °C
Time of actual peak temperature	$t_p$	Max. 10 seconds Max. 5 second each wave	Max. 10 seconds Max. 5 second each wave
Ramp-down rate min.		~ 2 °C/second	~ 2 °C/second
Ramp-down rate typical		~ 3.5 °C/second	~ 3.5 °C/second
Ramp-down rate max.		~ 5 °C/second	~ 5 °C/second
Time 25°C to 25°C		4 minutes	4 minutes

### LOAD CONNECTING METHOD

Type	Load	Connection	Feature
4 pins	AC or DC		Control bi-directional signal
6 pins	A		Control bi-directional signal
	B		On-resistance is 1/2 of A-connection 2-Make-contacts (Source Common)
C		On-Resistance is 1/2 of B-connection	
8 pins	AC or DC		2 input and 2 output
			1 input and 2 output

## PRODUCT CODE

Example: AC45F series ▲ 2 Form A ▲ 60V ▲ SMD-8 ▲ Tape & Reel

AC		45		-		F		R1	
Package		Series		Special Suffix		Type		Packing	
AA	6 Pin ▲ 1 Form A	45	60V	Blank	Standard High Insulation	Blank	DIP	Blank R1	Tube Reel
AB	4 Pin ▲ 1 Form A			H		SMD			
AC	8 Pin ▲ 2 Form A			S	SOP				

## PRODUCT MARKING

Example: AC45F series ▲ 2 Form A ▲ 60V ▲ SMD-8 ▲ Tape & Reel

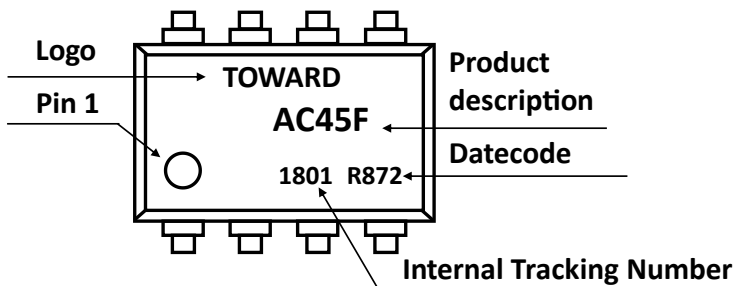

## DATE CODE

Example: R872

R		8		7		2	
Material Characteristics		Year		Month		Week of the Month	
R	RoHS compliant	8	2018	1	Jan	1	1 <sup>st</sup>
		9	2019	2	Feb		
		A	2020	3	Mar		
		B	2021	4	Apr		
H	Halogen free	C	2022	5	May	2	2 <sup>nd</sup>
		...	...	...	...	3	3 <sup>rd</sup>
		G	2026	12	Dec	4	4 <sup>th</sup>

**RELIABILITY TESTS ▲ STANDARD**

Standard: JESD22-A

No.	Test	Test Specification	Test Standard	Test Limits
1	Moisture Sensitivity Level Test	Bake condition: Temperature: 125°C; Duration 24 hours Soak condition: Temperature: 30°C; Humidity: 60% RH Duration 192 hours Reflow condition: Peak temperature: 260°C Duration: 3 cycles	JESD22-A113H	No abnormal phenomenon was found. Functional test passed.
2	High Temperature Storage Test	Temperature: 150°C Duration: 500 hours	JESD22-A103E	No abnormal phenomenon was found. Functional test passed.
3	Temperature Cycling Test	Temperature range: -55°C to +125°C -55°C for 30 minutes +125°C for 30 minutes Duration: 100 cycles with 1 cycle = 70 minutes	JESD22-A104E	No abnormal phenomenon was found. Functional test passed.
4	Low Temperature Storage Test	Temperature: -40°C Duration: 500 hours	JESD22-A119E	No abnormal phenomenon was found. Functional test passed.
5	Temperature & Humidity Storage Test	Temperature: 85°C Humidity: 85% RH Duration: 500 hours	JESD22-A101D	No abnormal phenomenon was found. Functional test passed.
6	Highly Accelerated Temperature and Humidity Stress Test	Temperature: 130°C Humidity: 85% RH Duration: 96 hours	JESD22-A-118B	No abnormal phenomenon was found. Functional test passed.

## REVISION TABLE

Revision	Date	Status	Notes
001	01/10/2021	Initial release	Initial publication

## DISCLAIMER

Except for the written expressed warranties, MGT does not implicitly, by assumption or whatever else, warrant, undertake, promise any other warranty or guaranty for any MGT product.

All information and technical specifications made available by MGT are for guidance only and we reserve the right to change or modify them without prior notice. Unless expressly stated in writing by MGT, we reject any guarantees, obligations, or warranties.

All MGT products with the technical specifications described are suitable for use in certain applications. Operating, production, storage and environmental conditions can have a massive influence on the parameters mentioned in the data sheets, which cause the performance to vary over time.

It is subject to the user's duty of care to design and validate his products in such a way that appropriate measures are taken, such as protective circuits or redundant systems to ensure the safety standards required in the application.

MGT components are not designed or rated for use in life support, rescue, safety critical, military, or aerospace applications where failure or malfunction could result in property or environmental damage, serious injury or death. In the aforementioned cases, please contact us before using MGT products.

In principle, we reserve all rights and MGT's general terms and conditions apply. You can find them on our website [www.mgt.co.com](http://www.mgt.co.com).

## X-ON Electronics

Largest Supplier of Electrical and Electronic Components

*Click to view similar products for [Transistor Output Optocouplers](#) category:*

*Click to view products by [MGT Brightek](#) manufacturer:*

Other Similar products are found below :

[LTV-814S-TA](#) [LTV-8241S](#) [LTV-852S](#) [66095-001](#) [PS2561-1-A](#) [PS2561A-1-W-A](#) [PS2561L1-1-A](#) [PS2561L-1-V-A](#) [PS2706-1-A](#) [PS2815-1-A](#)  
[MRF658](#) [ILD2-X006](#) [ILQ615-3X016](#) [LDA102S](#) [SFH615A-4XSM TR](#) [PS2561DL-1Y-F3-A](#) [PS2561L1-1-L-A](#) [PS2562-1-V-A](#) [PS2565L-1-A](#)  
[PS2581L2-A](#) [PS2701A-1-F3-P-A](#) [PS2711-1-A](#) [PS2801-1-F3-P-A](#) [PS2833-4-A](#) [PS2841-4A-AX](#) [LTV-702FS](#) [LTV-702V](#) [LTV-702VB](#) [LTV-](#)  
[816S-TA](#) [LTV-825S](#) [TCET2100](#) [TLP290-4\(E\(T](#) [IL215AT](#) [WPPC-A11066AA](#) [WPPC-A11066AD](#) [WPPC-A11084ASS](#) [WPPC-A21068AA](#)  
[WPPC-D11066AA](#) [WPPC-D21068ED](#) [WPPC-D410616EA](#) [WPPC-D410616ED](#) [X4IAC24A](#) [4N26-X001](#) [EL1010\(TA\)-VG](#) [SFH600-2X007](#)  
[TCMT1118](#) [VO206AT](#) [WPPC-D21068EA](#) [WPPC-D11064AD](#) [WPPC-A410616AD](#)