



**BRIGHTTEK**  
**BRIGHTTEK (EUROPE) LIMITED**

*Brighten Up The World With LED!*



ISO/TS 16949:2009



BS EN ISO 14001:2004



QC 080000 IECQ HSPM

## PRODUCT DATASHEET



- ▶ PCB / CHIP LED
- ▶ 0805 (1.1t)
- ▶ Blue (470nm)

NOB10S41



Release Date: 23 July 2014 Version: A1.0

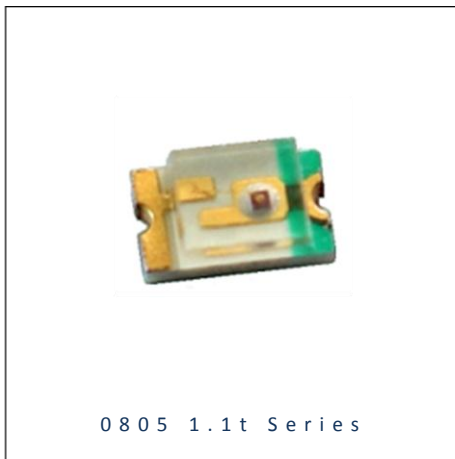

### 0805 1.1t Series

**RoHS**  
Compliant



#### FEATURES:

- **Package:** PCB / CHIP LED
- **Forward Current:** 20mA
- **Forward Voltage (typ.):** 3.1V
- **Luminous Intensity (typ.):** 120mcd @20mA
- **Colour:** Blue
- **Wavelength:** 470nm
- **Viewing angle:** 140°
- **Materials:**
  - Die: InGaN
  - Resin: Epoxy (Water Clear)
- **Operating Temperature:** -40~+80°C
- **Storage Temperature:** -40~+85°C
- **Grouping parameters:**
  - Forward voltage
  - Luminous intensity
  - Dominant wavelength
- **Soldering methods:** Reflow
- **Preconditioning:** acc. to JEDEC Level 3
- **Packing:** 8mm tape with 3000/reel, ø180mm (7")

#### APPLICATIONS:

- Backlighting
- Indication Light
- Switch light
- Dashboard

## CHARACTERISTICS:

### Absolute Maximum Characteristics (Ta=25°C)

| Parameter                          | Symbol    | Ratings | Unit    |
|------------------------------------|-----------|---------|---------|
| Forward Current                    | $I_F$     | 30      | mA      |
| Peak Forward Current Duty 1/8@1KHz | $I_{FP}$  | 125     | mA      |
| Reverse Current @5V                | $I_R$     | 10      | $\mu$ A |
| Power Dissipation                  | PD        | 111     | mW      |
| Operating Temperature              | $T_{OPR}$ | -40~+80 | °C      |
| Storage Temperature                | $T_{STG}$ | -40~+85 | °C      |

### Electrical & Optical Characteristics (Ta=25°C)

| Parameter                    | Symbol           | Values |      |      | Unit | Test Condition |
|------------------------------|------------------|--------|------|------|------|----------------|
|                              |                  | Min.   | Typ. | Max. |      |                |
| Forward Voltage              | $V_F$            | 2.8    | 3.1  | 3.7  | V    | $I_F=20mA$     |
| Luminous Intensity           | $I_V$            | 80     | 120  | 200  | mcd  | $I_F=20mA$     |
| Dominant Wavelength          | $\lambda_D$      | 465    | 470  | 475  | nm   | $I_F=20mA$     |
| Peak Wavelength              | $\lambda_P$      | ---    | 465  | ---  | nm   | $I_F=20mA$     |
| Spectral Line Half Bandwidth | $\Delta \lambda$ | ---    | 22   | ---  | nm   | $I_F=20mA$     |
| Viewing Angle                | $2\theta_{1/2}$  | ---    | 140  | ---  | deg  | $I_F=20mA$     |

1. Luminous intensity ( $I_V$ )  $\pm 15\%$ , Forward Voltage ( $V_F$ )  $\pm 0.1V$ , Viewing angle( $2\theta_{1/2}$ )  $\pm 5\%$
2. IS standard testing

## OUTLINE DIMENSION:

Package Dimension:

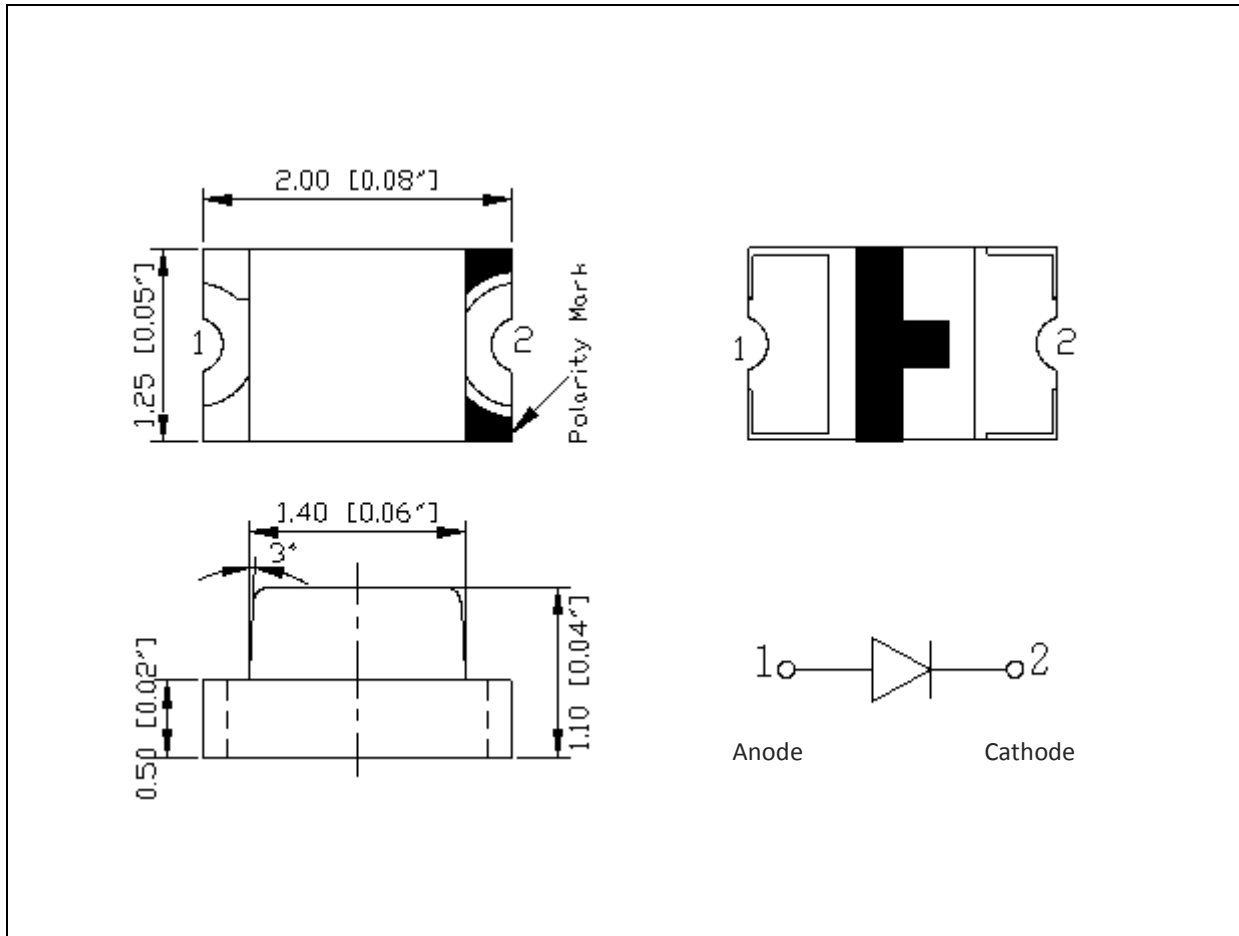

1. All dimensions are in millimetre (mm).
2. Tolerance  $\pm 0.2\text{mm}$ , unless otherwise noted.

Recommended Soldering Pad Dimension:

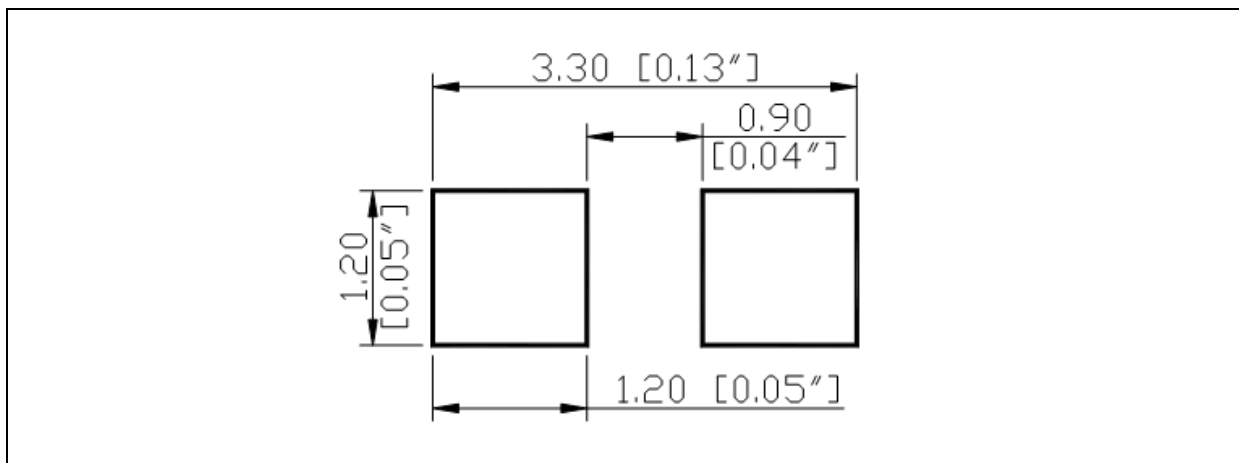

1. Dimensions are in millimetre (mm).
2. Tolerance  $\pm 0.1\text{mm}$  with angle tolerance  $\pm 0.5^\circ$ .

**BINNING GROUPS:**

---

 Forward Voltage Classifications ( $I_F = 20\text{mA}$ ):

| Code | Min. | Max. | Unit |
|------|------|------|------|
| F    | 2.8  | 3.1  | V    |
| G    | 3.1  | 3.4  |      |
| h    | 3.4  | 3.7  |      |

 Luminous Intensity Classifications ( $I_F = 20\text{mA}$ ):

| Code | Min. | Max. | Unit |
|------|------|------|------|
| I    | 80   | 100  | mcd  |
| J    | 100  | 125  |      |
| K    | 125  | 160  |      |
| L    | 160  | 200  |      |

 Dominant Wavelength Classifications ( $I_F = 20\text{mA}$ ):

| Code | Min.  | Max.  | Unit |
|------|-------|-------|------|
| G    | 465   | 467.5 | nm   |
| H    | 467.5 | 470   |      |
| I    | 470   | 472.5 |      |
| J    | 472.5 | 475   |      |

**ELECTRO-OPTICAL CHARACTERISTICS:**

Relative Spectral Distribution

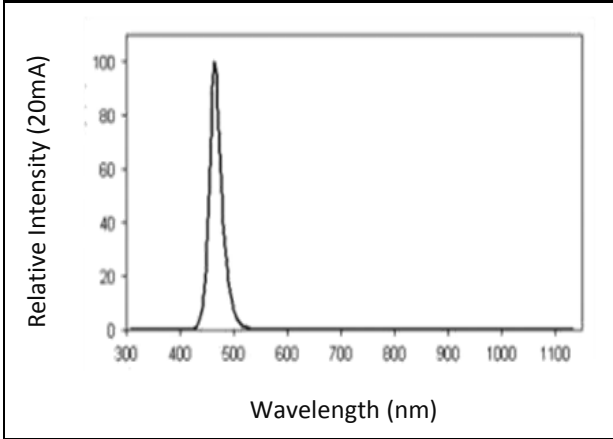

Forward Current v.s. Forward Voltage

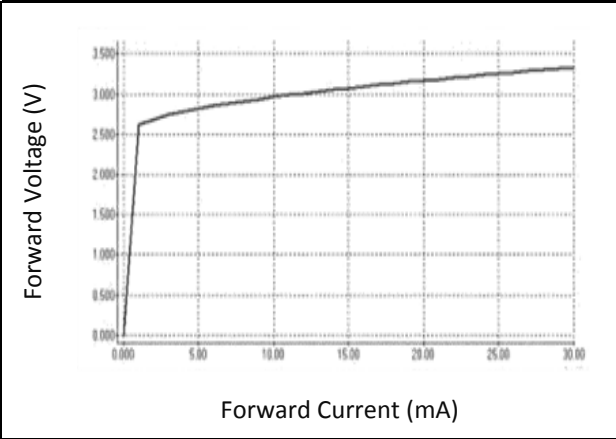

Directive Radiation

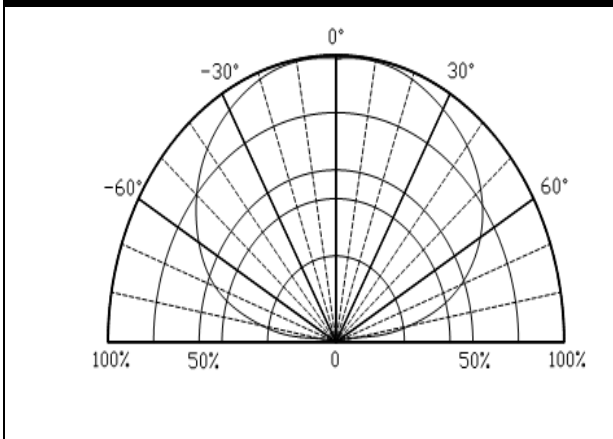

## RECOMMENDED SOLDERING PROFILE:

---

Reflow Solder:

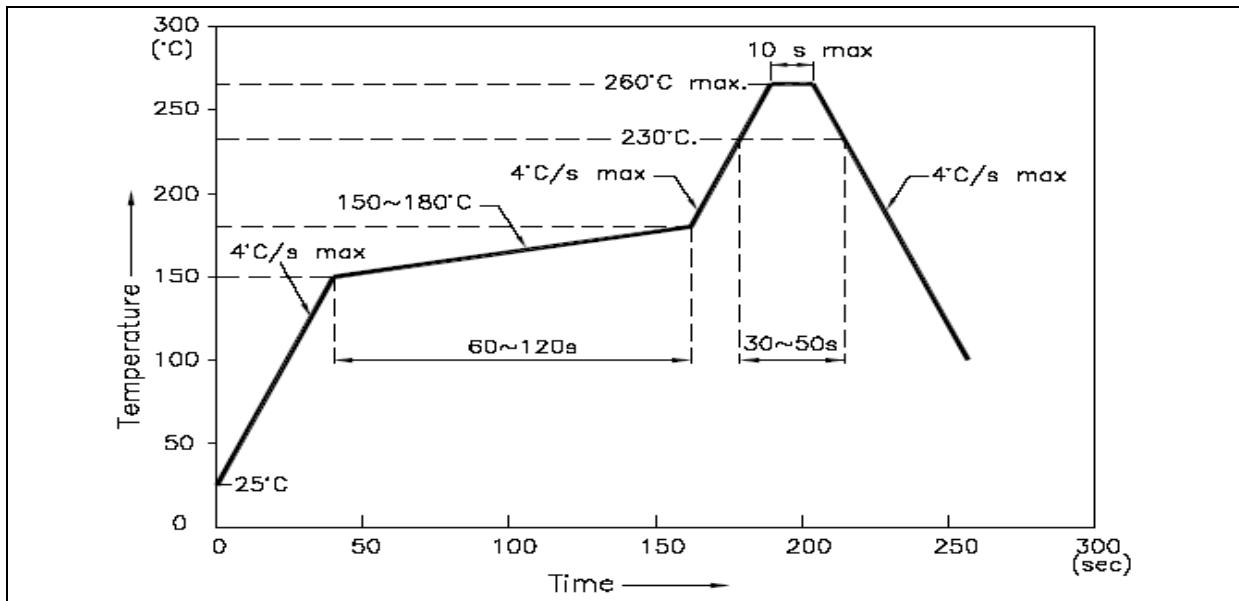

Note:

1. Recommend reflow temperature 245°C.
2. Maximum reflow soldering: 2 times.
3. Before, during, and after soldering, should not apply stress on the components and PCB board.



## PRECAUTIONS OF USE:

---

### Storage:

It is recommended to store the products in the following conditions:

- Humidity: 60% R.H. Max.
- Temperature: 5°C~30°C (41°F ~86°F).

Shelf life in sealed bag: 12 month at 5°C~30°C and <60% R.H.

Once the package is opened, the products should be used within a week. Otherwise, they should be kept in a damp-proof box with desiccating agent and apply baking at 60°C±5°C for 15hrs before use.

### Baking:

It is recommended to bake the LED before soldering if the pack has been unsealed for longer than 24hrs.

The suggested baking conditions are as followings:

- 70±3°C x 24hrs and <5%RH, taped / reel package.
- 100±3°C x 2hrs, bulk (loose) package.
- 130±3°C x 30min, bulk (loose) package.

It's normal to see slight color fading of carrier (light yellow) after baking in process.

### Testing Circuit:

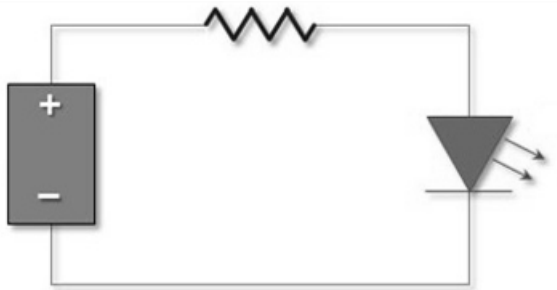

Must apply resistor(s) for protection (over current proof).

### Cleaning:

Use alcohol-based cleaning solvents such as isopropyl alcohol to clean the LED carrier / package. Avoid putting any stress force directly on to the LED lens.

### ESD (Electrostatic Discharge):

Static Electricity or power surge will damage the LED. Use of a conductive wrist band or anti-electrostatic glove is recommended when handling the LED all time. All devices, equipment, machinery, work tables, and storage racks must be properly grounded.

In the events of manual working in process, make sure the devices are well protected from ESD at any time.



**REVISION RECORD:**

---

| Version | Date       | Summary of Revision |
|---------|------------|---------------------|
| A1.0    | 23/07/2014 | Datasheet set-up.   |

## X-ON Electronics

Largest Supplier of Electrical and Electronic Components

*Click to view similar products for [Standard LEDs - SMD category](#):*

*Click to view products by [MGT Brightek manufacturer](#):*

Other Similar products are found below :

[LTST-C190KYKT](#) [LTST-C19GD2WT](#) [LTW-170ZDC](#) [LTW-M140SZS40](#) [LTW-M140ZVS](#) [598-8110-100F](#) [598-8610-202F](#) [91-21SUBCS400-A6TR7](#) [AAAF5060QBFSEEZGS](#) [APT1608QGW](#) [99-213/R6C-AR2T1B/2C](#) [SML-LX0606SISUGC/A](#) [SML-LXR851SIUPGUBC](#) [LT1ED53A](#) [APFA3010SURKCGKQBDC](#) [APHK1608VGCA](#) [APT2012QGW](#) [LTST-008BGEW](#) [LTW-010DCG](#) [LTW-020ZDCG](#) [LTW-21TS5](#) [LTW-220DS5](#) [598-8330-117F](#) [65-21SYGC/S530-E3/TR8](#) [CMDA20AYAA7D1S](#) [95-21SURCS530-A3TR10](#) [598-8040-100F](#) [598-8070-100F](#) [598-8140-100F](#) [598-8610-200F](#) [SML-LXR851SGSIC-TR](#) [SML-512PWT86A](#) [SMF-2432GYC-TR](#) [EASV3015RGYA0](#) [95-21UYC-S530-A5-TR7](#) [LTST-C190KFKT-5A](#) [LTST-C194TBKT-5A](#) [CLX6E-FKC-CH1M1D1BB7C3D3](#) [SML-LXL0805USBC-TR](#) [SML-LX2835SYSUGCTR](#) [LTW-M670ZVS-M5](#) [APA2106ZGC/G](#) [CLMXB-FKA-CbcfghjnpACBB79463](#) [VFA1101W-5AY3B2-TR](#) [LCB P473-P2R2-3J7L-1-Z](#) [91-21VGC/S556/S68/TR10/S370](#) [LW A67C-S2U1-FK0KM0](#) [LW A673-P1S1-FK0PM0](#) [BL-HE1G033B-TRB](#) [5988B90107F](#)