



BRIGHTTEK
BRIGHTTEK (EUROPE) LIMITED

Brighten Up The World With LED!



ISO/TS 16949:2009



BS EN ISO 14001:2004



QC 080000 IECQ HSPM

PRODUCT DATASHEET



- ▶ PLCC2 Top View
- ▶ 1608 0.55t Series
- ▶ True Green (525~540nm)

NOG51S61-2MA



Release Date: 21 October 2022 Version: A1.2



1608 0.55t Series

RoHS Compliant



FEATURES:

- **Package:** PLCC2 SMT Top View Package
- **Forward Current:** 2~20mA
- **Forward Voltage (typ.):** 2.6V@2mA
- **Luminous Intensity (typ.):** 60mcd@2mA; 280mcd@20mA
- **Colour:** True Green
- **Wavelength:** 525~540nm
- **Viewing angle:** 120°
- **Materials:**
 - Resin: Silicon (White Diffused)
 - L/T Finish: Ag plated
- **Operating Temperature:** -40~+105°C
- **Storage Temperature:** -40~+105°C
- **Grouping parameters:**
 - Forward Voltage
 - Luminous Intensity
 - Dominant Wavelength
- **Soldering methods:** Reflow
- **Preconditioning:** MSL2a according to J-STD020
- **Packing:** 8mm tape with max.4000pcs /reel, ø180mm (7")

APPLICATIONS:

- Automotive Interior Lighting
- Decorative Lighting
- Back Light for LCD

CHARACTERISTICS:

Absolute Maximum Characteristics (Ta=25°C)

Parameter	Symbol	Ratings	Unit
DC Forward Current	I _F	30	mA
Pulse Forward Current Duty 1/10, Pulse Width 0.1mS	I _{PF}	100	mA
Reverse Voltage	V _R	5	V
Reverse Current @5V	I _R	10	μA
Junction Temperature	T _j	125	°C
Thermal Resistance Junction to Solder Point	R _{THJ-S}	130	°C/W
Thermal Resistance Junction to Ambient Point	R _{THJ-A}	260	°C/W
Electrostatic Discharge (HBM)	ESD	1000	V
Operating Temperature	T _{OPR}	-40~+105	°C
Storage Temperature	T _{STG}	-40~+105	°C
Soldering Temperature	T _{SOL}	260	°C

Electrical & Optical Characteristics (Ta=25°C)

Parameter	Symbol	Values			Unit	Test Condition
		Min.	Typ.	Max.		
Forward Voltage	V _F	2.4	2.6	3.4	V	I _F =2mA
Luminous Intensity	I _v	40	60	---	mcd	I _F =2mA
Dominant Wavelength	λ _D	525	---	540	nm	I _F =2mA
Peak Wavelength	λ _P	---	526	---	nm	I _F =2mA
Spectral Width 50%	Δλ	---	33	---	nm	I _F =2mA
Viewing Angle	2θ _{1/2}	---	120	---	deg	I _F =2mA

1. Luminous intensity (I_v) ±10%, Forward Voltage (V_F) ±0.1V, Viewing angle(2θ_{1/2}) ±5°

OUTLINE DIMENSION:

Package Dimension:

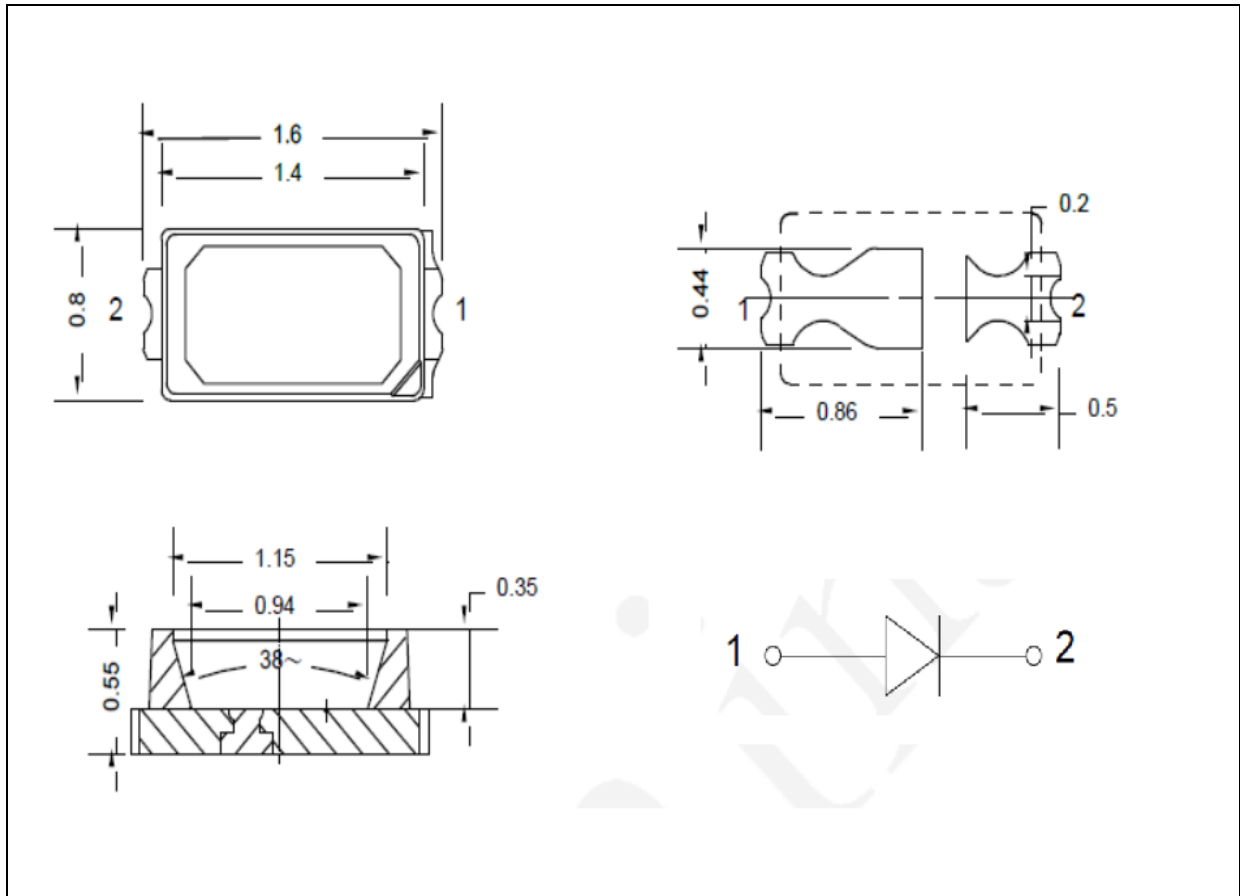

1. All dimensions are in millimetre (mm).
2. Tolerance ± 0.13 mm, unless otherwise noted.

Recommended Soldering Pad Dimension:

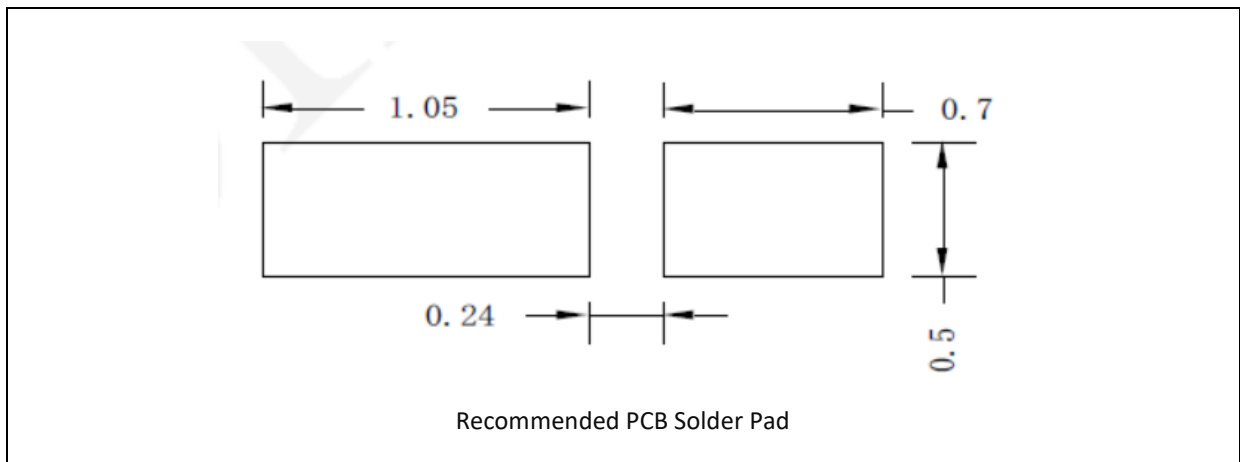

1. Dimensions are in millimetre (mm).
2. Tolerance ± 0.12 mm with angle tolerance $\pm 0.5^\circ$.

BINNING GROUPS:

 Forward Voltage Classifications ($I_F = 2\text{mA}$):

Code	Min.	Max.	Unit
I	2.4	2.6	V
J	2.6	2.8	
K	2.8	3.0	
L	3.0	3.2	
M	3.2	3.4	

 Luminous Intensity Classifications ($I_F = 2\text{mA}$):

Code	Min.	Max.	Unit
8	40	50	mcd
9	50	63	
10	63	80	
11	80	100	

 Dominant Wavelength Classifications ($I_F = 2\text{mA}$):

Code	Min.	Max.	Unit
G6	525	530	nm
G7	530	535	
G8	535	540	

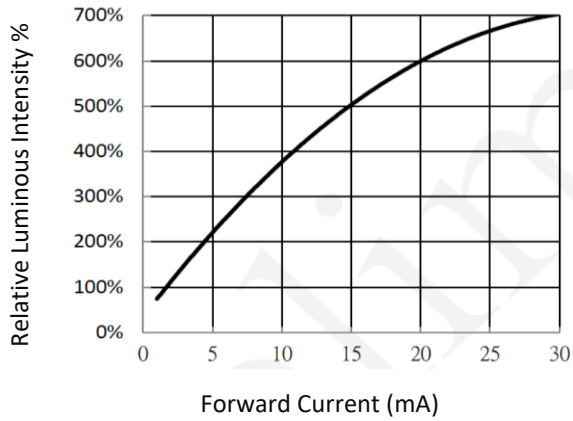
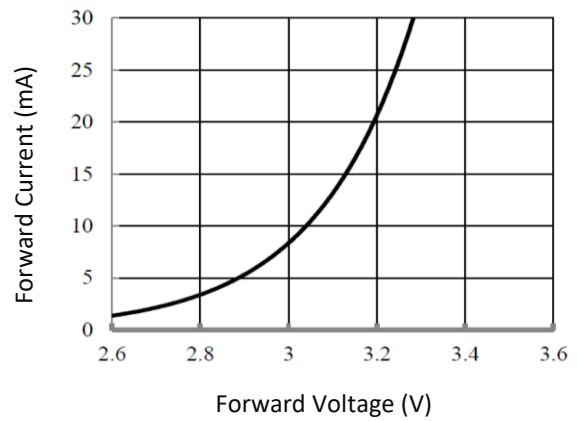
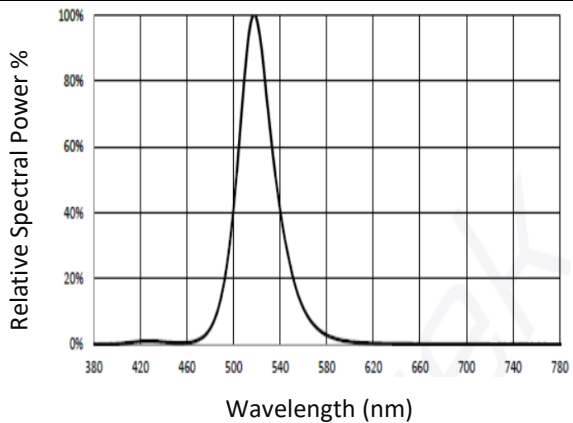
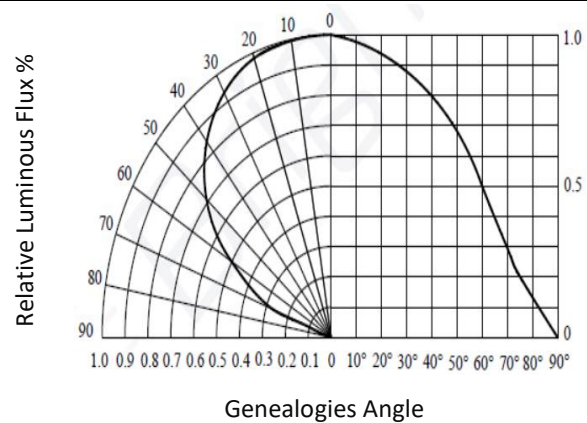
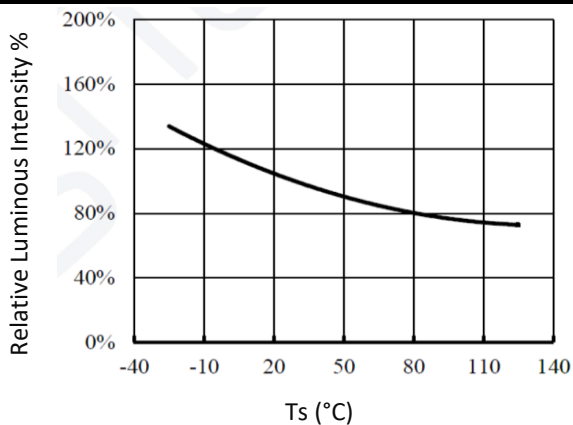
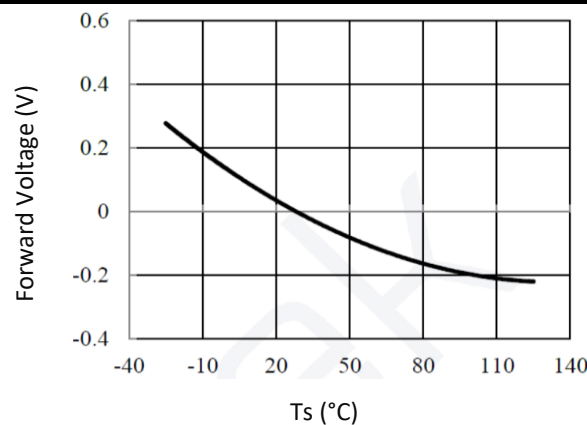
ELECTRO-OPTICAL CHARACTERISTICS:
Relative Luminous Intensity v.s. Forward Current

Forward Current v.s. Forward Voltage

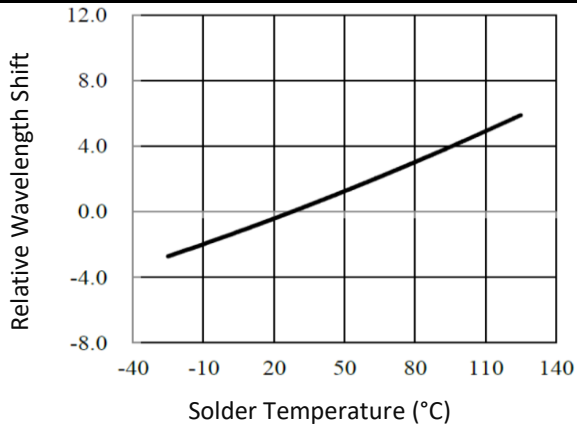
Relative Spectral Power v.s. Wavelength

Directive Radiation

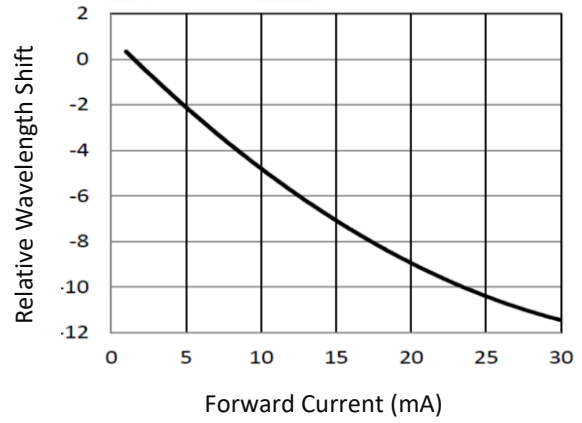
Relative Luminous Intensity v.s. Solder Temp.

Forward Voltage v.s. Solder Temperature

Wavelength Shift v.s. Solder Temperature



Wavelength Shift v.s. Forward Current



Forward Current Derating Curve

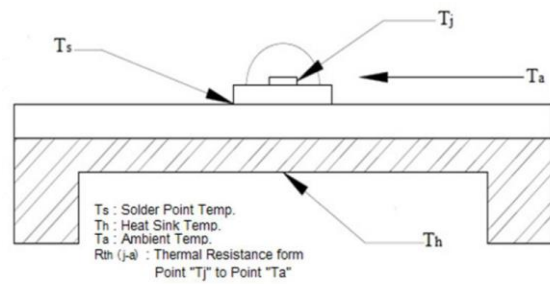
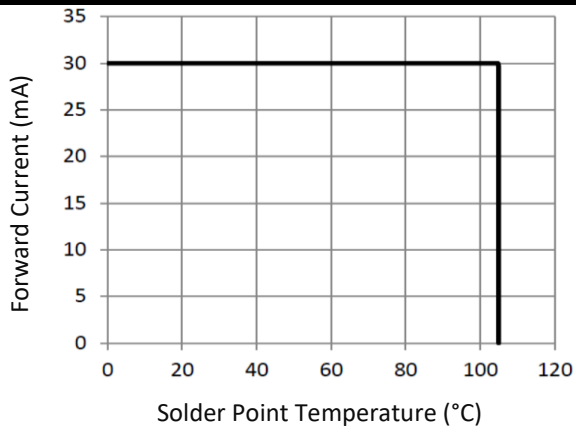

RECOMMENDED SOLDERING PROFILE:

Reflow Lead-free Solder:

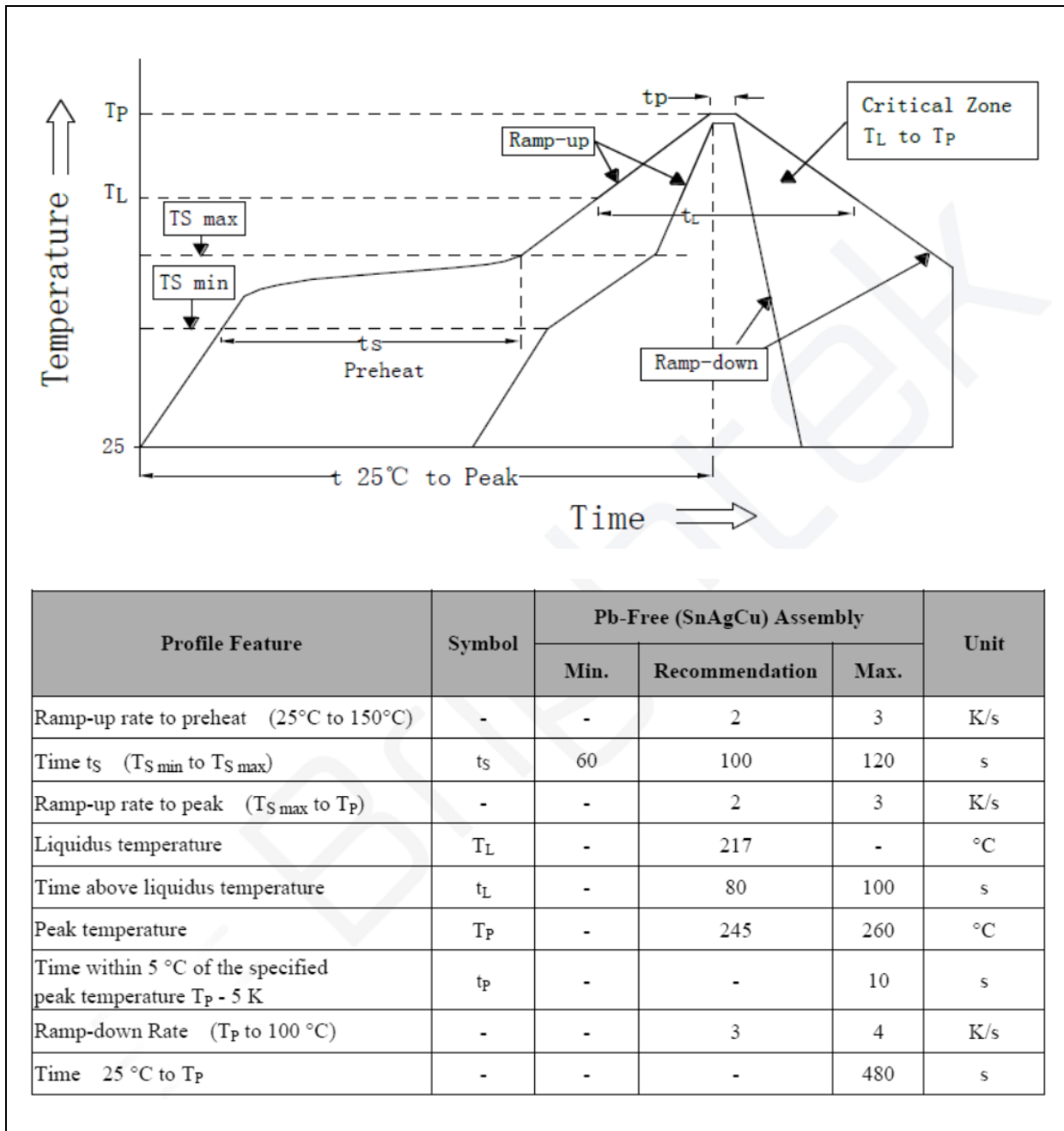

Note:

1. Maximum reflow soldering: 3 times.
2. The recommended reflow temperature is 240°C. The maximum soldering temperature should be limited to 260°C.
3. Before, during, and after soldering, should not apply stress on the components and PCB board.

PACKING SPECIFICATION:

Reel Dimension:

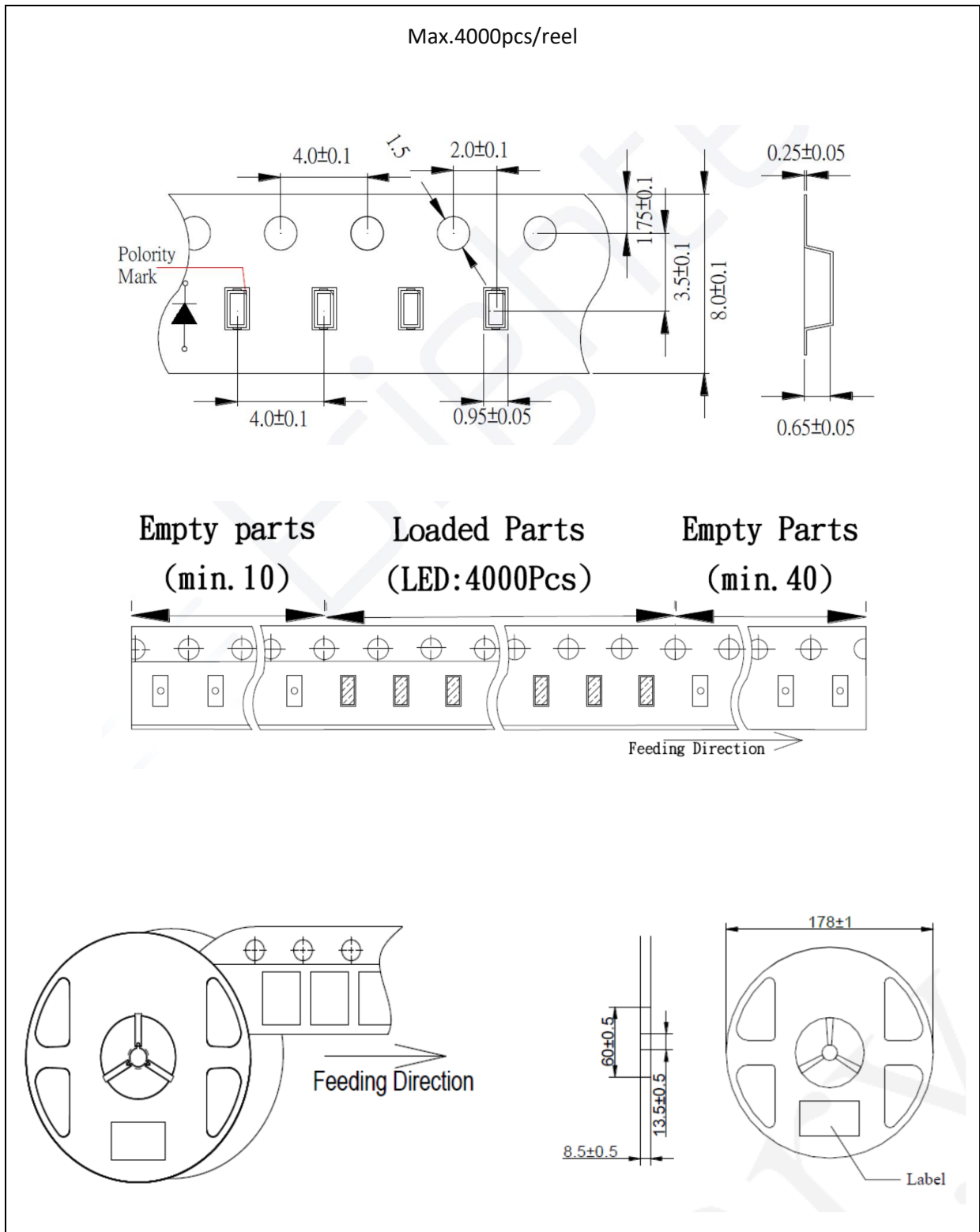

PRECAUTIONS OF USE:

Storage:

It is recommended to store the products in the following conditions:

- Humidity: 60% R.H. Max.
- Temperature: 5°C~30°C (41°F ~86°F).

Shelf life in sealed bag: 12 months at 5°C~30°C and <60% R.H.

Once the package is opened, the products should be used within a week. Otherwise, they should be kept in a damp-proof box with desiccating agent <10% R.H. and apply baking before use.

Baking:

It is recommended to bake the LED before soldering if the pack has been unsealed for longer than 24hrs. The suggested baking conditions are as followings:

- 60±3°C x 6hrs and <5%RH, taped / reel package.

It's normal to see slight color fading of carrier (light yellow) after baking in process.

Testing Circuit:



Must apply resistor(s) for protection (over current proof).

Cleaning:

Use alcohol-based cleaning solvents such as isopropyl alcohol to clean the LED carrier / package. Avoid putting any stress force directly on to the LED lens.

ESD (Electrostatic Discharge):

Static Electricity or power surge will damage the LED. Use of a conductive wrist band or anti-electrosatic glove is recommended when handling the LED all time. All devices, equipment, machinery, work tables, and storage racks must be properly grounded.

In the events of manual working in process, make sure the devices are well protected from ESD at any time.

REVISION RECORD:

Version	Date	Summary of Revision
A1.0	28/04/2020	Datasheet set-up.
A1.1	22/04/2022	New datasheet format.
A1.2	21/10/2022	Update dimensions drawing, ESD, and curves.

X-ON Electronics

Largest Supplier of Electrical and Electronic Components

Click to view similar products for [Standard LEDs - SMD category](#):

Click to view products by [MGT Brightek manufacturer](#):

Other Similar products are found below :

[LTST-C190KYKT](#) [LTST-C19GD2WT](#) [LTST-N683GBEW](#) [LTW-170ZDC](#) [LTW-M140SZS40](#) [598-8110-100F](#) [598-8610-202F](#)
[AAAF5060QBFSEEZGS](#) [APT1608QGW](#) [EAST2012YA0](#) [SML-512VWT86A](#) [SML-LX0606SISUGC/A](#) [SML-LXR851SIUPGUBC](#)
[LT1ED53A](#) [AM27ZGC03](#) [APFA3010SURKCGKQBDC](#) [APHK1608VGCA](#) [APT2012QGW](#) [CLX6D-FKB-CN1R1H1BB7D3D3](#) [LTST-](#)
[008BGEW](#) [LTW-010DCG](#) [LTW-020ZDCG](#) [LTW-21TS5](#) [LTW-220DS5](#) [598-8330-117F](#) [SML-LX0402IC-TR](#) [CMDA20AYAA7D1S](#)
[CMDA16AYDR7A1X](#) [598-8040-100F](#) [598-8070-100F](#) [598-8140-100F](#) [598-8610-200F](#) [EAST2012GA0](#) [EAPL3527GA5](#) [EAST2012RA0](#)
[CMD91-21VRC/TR7](#) [SML-512PWT86A](#) [SMF-2432GYC-TR](#) [EASV3015RGYA0](#) [LTST-C190KFKT-5A](#) [LTST-C194TBKT-5A](#) [CLX6E-](#)
[FKC-CH1M1D1BB7C3D3](#) [SML-LXL0805USBC-TR](#) [SML-LX2835SYSUGCTR](#) [LTW-M670ZVS-M5](#) [APA2106ZGC/G](#) [CLMXB-FKA-](#)
[CbcfghjnpACBB79463](#) [VFA1101W-5AY3B2-TR](#) [LCB P473-P2R2-3J7L-1-Z](#) [HSMR-C197](#)