



**BRIGHTTEK**  
BRIGHTTEK (EUROPE) LIMITED

*Brighten up The World With LED!*



ISO/TS 16949:2009



BS EN ISO 14001:2004



QC 080000 IECQ HSPM

## PRODUCT DATASHEET



- ▶ PTH/THT Lamp
- ▶ 3mm Round 5.3t
- ▶ Phototransistor (PT)  
for matching NOF00L29

NOP47L84 (Bulk)  
NOP47L84T (Tape)



Release Date: 14 December 2023 Version: A1.1



3 m m R o u n d L a m p

### 3mm Round Lamp

**RoHS**  
Compliant



#### FEATURES:

NOP47L84 consist of NPN silicon phototransistor mounted in clear lens, is mechanically and spectrally matched to infrared emitting diode NOF00L29 or similar.

- **Package:** PTH/THT LED Lamp 3mm Round 5.3t
- **Wavelength of Max. Sensitivity (typ.):** 950nm
- **Receiving Angle:** 30°
- **Materials:**
  - Die: Silicon
  - Resin: Epoxy (Black Clear)
- **Operating Temperature:** -40~+85°C
- **Storage Temperature:** -50~+100°C
- **Soldering Methods:** Hand; Soldering Heat (DIP)
- **Packing:** 500pcs/bulk; 2000pcs/tape (Ammo Pack)

#### APPLICATIONS:

- Remote Control
- Automatic Control System
- Burglar Alarm
- Photo Detector
- Smoke
- Detector
- Computer I/O Peripheral
- Industrial Use

## CHARACTERISTICS:

### Absolute Maximum Characteristics (Ta=25°C)

Parameter	Symbol	Ratings	Unit
Emitter-Collector Breakdown Voltage	$BV_{ECO}$	5	V
Collector-Emitter Sustaining Voltage	$V_{CE}$	30	V
Power Dissipation	$P_D$	100	mW
Operating Temperature	$T_{OPR}$	-40~+85	°C
Storage Temperature	$T_{STG}$	-50~+100	°C
Relative Humidity at 85°C	$H_R$	85	%

### Electrical & Optical Characteristics (Ta=25°C)

Parameter	Symbol	Values			Unit	Test Condition
		Min.	Typ.	Max.		
Collector-Emitter Sustaining Voltage	$V_{CE}$	30	60	---	V	$I_c=0.5mA$ $E_e=0mW/cm^2$
Collector-Emitter Saturation Voltage	$V_{CE(SAT)}$	---	0.4	---	V	$I_c=100\mu A$ $E_e=0.6mW/cm^2$
Emitter-Collector Breakdown Voltage	$BV_{ECO}$	5	7	---	V	$I_e=100\mu A$ $E_e=0mW/cm^2$
Dark Current	$I_D$	---	---	100	nA	$V_{CE}=10V$ $E_e=0mW/cm^2$
Photo Current	$I_L$	1	5	---	mA	$V_{CE}=5V$ $E_e=1.0mW/cm^2$
Rise Time (10% to 90%)	$T_R$	---	10	---	$\mu S$	$V_{CC}=5V$ $I_L=800\mu A$ $R_L=1K OHM$
Fall Time (90% to 10%)	$T_F$	---	15	---	$\mu S$	

**OUTLINE DIMENSION:**

Package Dimension:

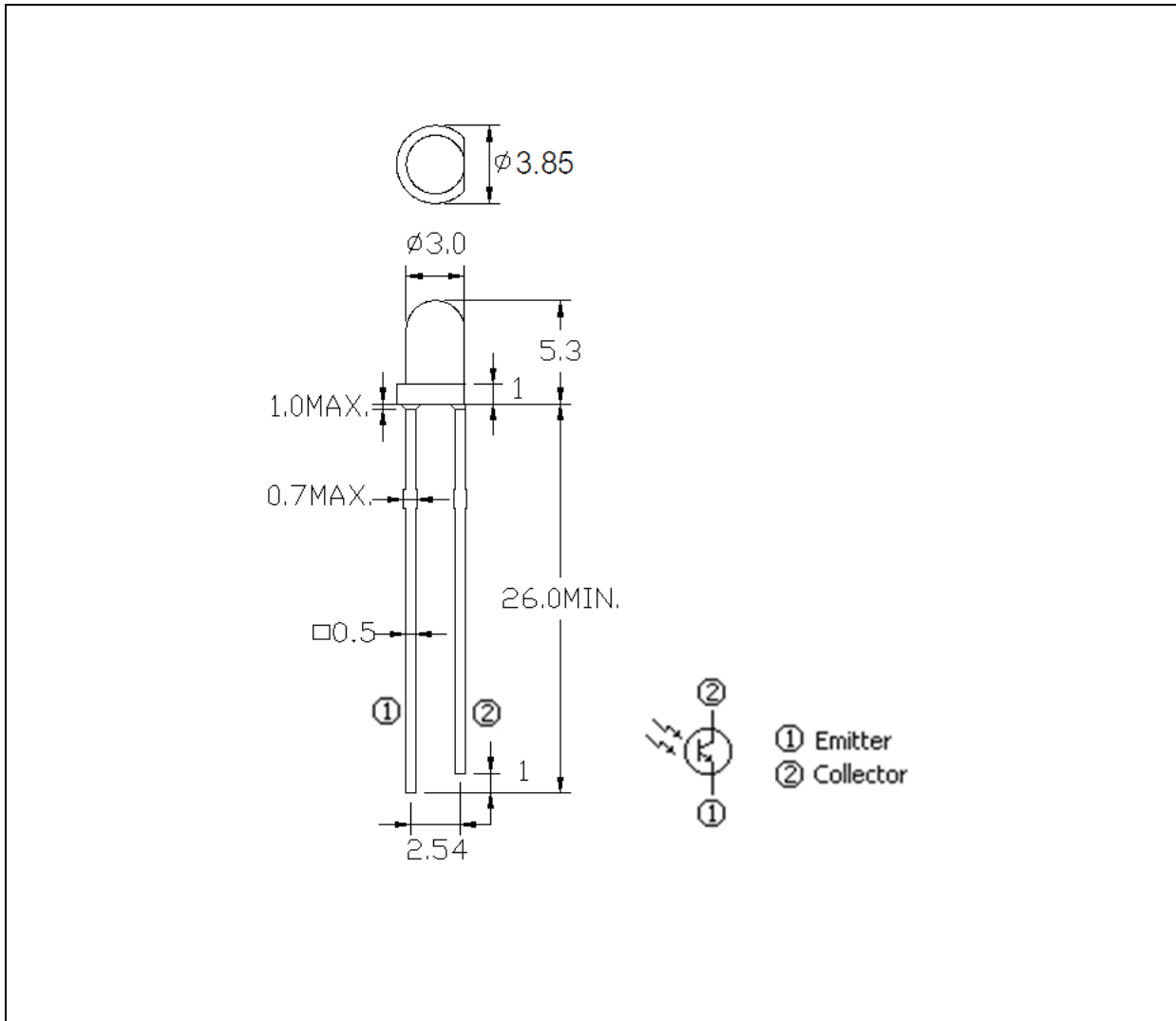

1. All dimensions are in millimetre (mm).
2. Tolerance  $\pm 0.2$ mm, unless otherwise noted.

## ELECTRO-OPTICAL CHARACTERISTICS:

Collector Dark Current v.s. Ambient Temperature

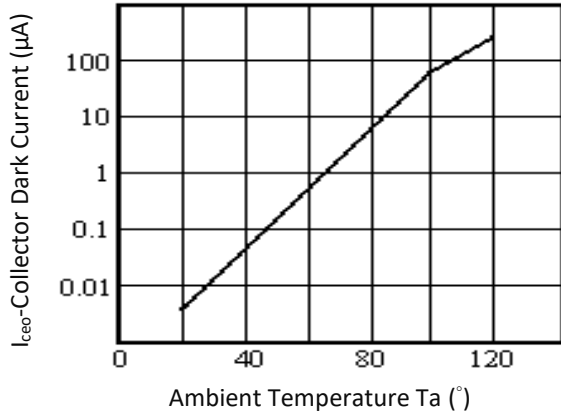

Normalized Collect Current v.s. Ambient Temp.

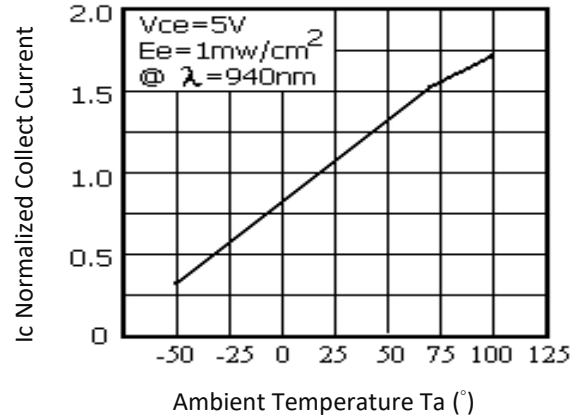

Rise and Fall Time v.s. Load Resistance

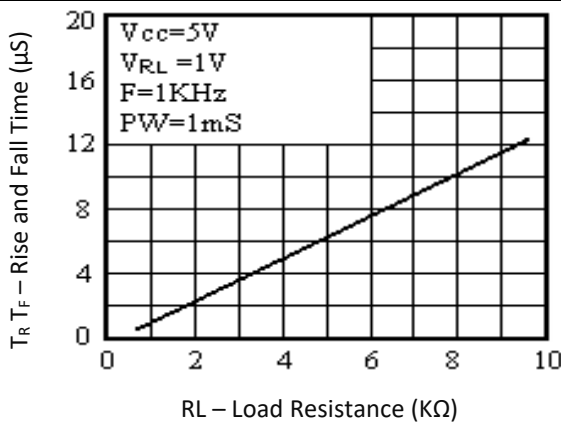

Relative Collector Current v.s. Irradiance

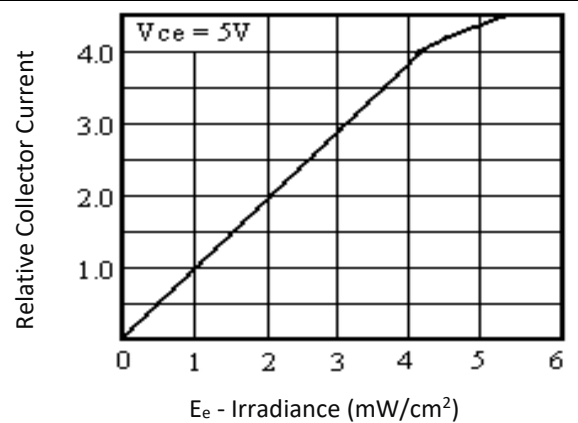

Phototransistor Relative Curves

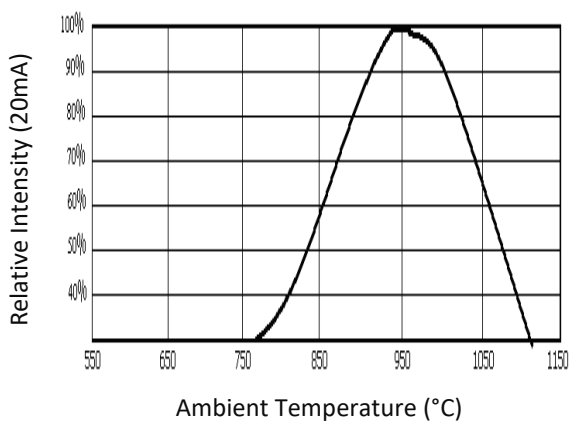

## RECOMMENDED SOLDERING PROFILE:

---

### Hand Solder (Solder Iron):

- Temperature at tip of iron: 350°C Max.
- Soldering Time: 3 seconds  $\pm$  1 sec.

### Soldering Heat (DIP):



### Note:

1. Maximum reflow soldering: 1 time.
2. Before, during, and after soldering, should not apply stress on the components and PCB board.

**PACKING SPECIFICATION:**

---

Reel Dimension:

500pcs/Bulk

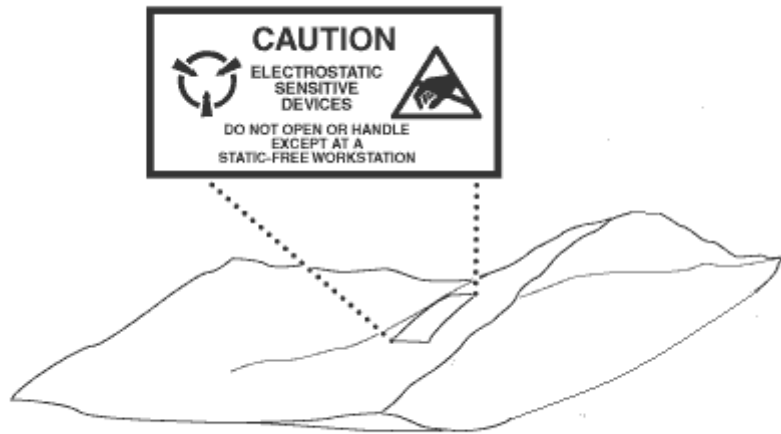

2000pcs/Taping

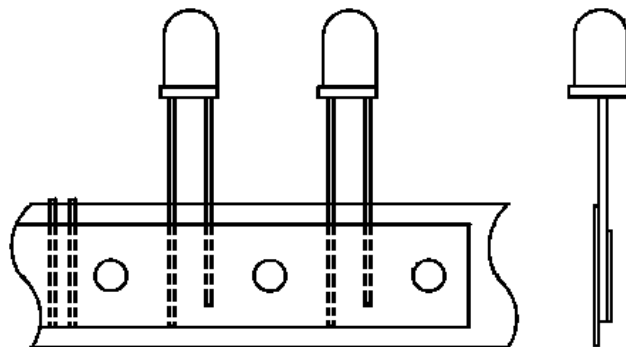

## PRECAUTIONS OF USE:

---

### Storage:

It is recommended to store the products in the following conditions:

- Humidity: 60% R.H. Max.
- Temperature: 5°C~30°C (41°F ~86°F).

Shelf life in sealed bag: 12 months at 5°C~30°C and <60% R.H.

Once the package is opened, the products should be used within a week. Otherwise, they should be kept in a damp-proof box with desiccating agent <10% R.H. and apply baking before use.

### Baking:

It is recommended to bake the LED before soldering if the pack has been unsealed for longer than 24hrs. The suggested baking conditions are as followings:

- 60±5°C x 24hrs and <5%RH, taped / reel package.

It's normal to see slight color fading of carrier (light yellow) after baking in process.

### Testing Circuit:



Must apply resistor(s) for protection (over current proof).

### Cleaning:

Use alcohol-based cleaning solvents such as isopropyl alcohol to clean the LED carrier / package. Avoid putting any stress force directly on to the LED lens.

### ESD (Electrostatic Discharge):

Static Electricity or power surge will damage the LED. Use of a conductive wrist band or anti-electrosatic glove is recommended when handling the LED all time. All devices, equipment, machinery, work tables, and storage racks must be properly grounded.

In the events of manual working in process, make sure the devices are well protected from ESD at any time.

**REVISION RECORD:**

---

Version	Date	Summary of Revision
A1.0	16/04/2023	Datasheet set-up.
A1.1	14/12/2023	Revise storage condition.



## X-ON Electronics

Largest Supplier of Electrical and Electronic Components

*Click to view similar products for [Phototransistors](#) category:*

*Click to view products by [MGT Brightek](#) manufacturer:*

Other Similar products are found below :

[LTR-526AD](#) [LTR-5576D](#) [QSD123A4R0](#) [ASDL-6620-C22](#) [OED-STR44B90-TR](#) [LTR-536AB](#) [LTR-743DBM1-TA](#) [SD5410-109](#) [PT91-21C/TR7](#) [L-51ROPT1D1](#) [PT928-6C\(X3-X5\)\(XBY\)](#) [PT908-7C\(BIN3\)](#) [PT19-21B/L41/TR8\(BY\)](#) [PT928-6C/F1\(6-1\)](#) [XYC-PT3020F65-L4](#) [DY-PT-8S302320B-6.5T](#) [DY-PTS302320B/6.5T](#) [XL-TD3216PDC](#) [MPT60363T\(SHW\)](#) [XYC-PT26B-L1](#) [XYC-PT2835F30-A4](#) [XYC-PT204B-L1](#) [XYC-PT17B-L1](#) [ZSPT-3216B-19D-T15](#) [ZSPT-3216C-19C-T15](#) [ZSPTP68C](#) [ZSPT0348B](#) [ZPT-Z3224B-T26-T15\(YPX\)](#) [ZSPT034B-N](#) [ZSPT034C-N](#) [PT67-21B/L606/TR8\(DVP-2\)](#) [PT8294-6B](#) [L-3DP3C](#) [XYC-PT3A940FC-A1](#) [XYC-PT19B-L1](#) [XYC-PT3216D25-A1](#) [XYC-PT3A940FC-A4](#) [XYC-PT3B850DC-A2](#) [XYC-PT3A850DC-A1](#) [XYC-PT5A850DC-A1](#) [XYC-PT3212D25-A1](#) [XYC-PT3A850DC-A2](#) [XYC-PT3A850DC-L1](#) [L32ROPT1D1](#) [ZSPT054B](#) [ZSPT868B-F14/H](#) [ZSPTP08C](#) [ZPT-1608B-06-Z4](#) [ZSPT054C](#) [ZSPTP28C](#)