

# UT8005B

## BIDIRECTIONAL ▲ TVS DIODE

TVS DIODE ▲ SMD type

ESD Protection for line

Bidirectional protection

Junction capacitance ▲ 15pF

0.6mm x 0.3mm x 0.3mm ▲ DFN0603-2L package

AEC-Q101 qualified

### SPECIFICATION

Item		Characteristics
Operating Junction Temperature Range	$T_J$	-55°C to +125°C
Storage Temperature Range	$T_S$	-55°C to +150°C
Peak Pulse Current (8/20 $\mu$ s)	$I_{PP}$	12.5A
ESD Rating (Per IEC 61000-4-2 ▲ Contact)	$V_{ESD}$	±30kV
ESD Rating (Per IEC 61000-4-2 ▲ Air)	$V_{ESD}$	±30kV

### DESCRIPTION

The UT8005B is a bidirectional Transient Voltage Suppressor (TVS) designed to protect 5.0V circuits from transient events such as high Electrostatic Discharge (ESD) and Cable Discharge Event (CDE).

This device uses a proprietary clamping cell technology. During transient events, these cells clamp transient over-voltages on power, control data signals and protect sensitive circuitry.

### EMC STANDARDS

- ▲ IEC 61000-4-2 (ESD): ±30kV (Contact)
- ▲ IEC 61000-4-2 (ESD): ±30kV (Air)
- ▲ IEC 61000-4-4 (EFT): 50A (5/50ns)
- ▲ IEC 61000-4-5 (Lightning): 12.5A (8/20 $\mu$ s)

### APPLICATIONS

Automotive	Battery Contacts	Computer Equipment	Digital Cameras	5V Systems

## PIN DESCRIPTION

Circuit Diagram - Bottom View

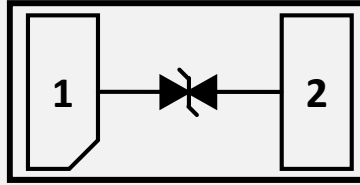

## ELECTRICAL CHARACTERISTICS ▲ $T_J = 25^\circ\text{C}$ , unless otherwise noted

Item	Condition	Symbol	Min.	Typ.	Max.	Unit
Reverse Working Voltage	Pin 1 to Pin 2	$V_{RWM}$	-5		5	V
Breakdown Voltage	$I_{BR} = 1\text{mA}$ , Pin 1 to Pin 2	$V_{BR}$	6		9	V
Reverse Leakage Current	$V_{RWM} = 5\text{V}$ , Pin 1 to Pin 2	$I_R$			1	$\mu\text{A}$
TLP Clamping Voltage <sup>Note1</sup>	$I_{TLP} = 16\text{A}$ , Pin 1 to Pin 2	$V_C$		7.2		V
TLP Dynamic Resistance <sup>Note2</sup>	Pin 1 to Pin 2	$R_{DYN}$		0.1		$\Omega$
Junction Capacitance	$V_R = 0\text{V}$ , $f = 1\text{MHz}$ , Pin 1 to Pin 2	$C_J$		15		pF

### Note

- 1:  $t_{\text{period}} = 100\text{ns}$ ,  $t_r = 1\text{ns}$   
 2:  $t_{\text{period}} = 100\text{ns}$ ,  $t_r = 1\text{ns}$

## TYPICAL OPERATING CHARACTERISTICS

Fig. 1 - Junction Capacitance (Pin 1 to Pin 2)

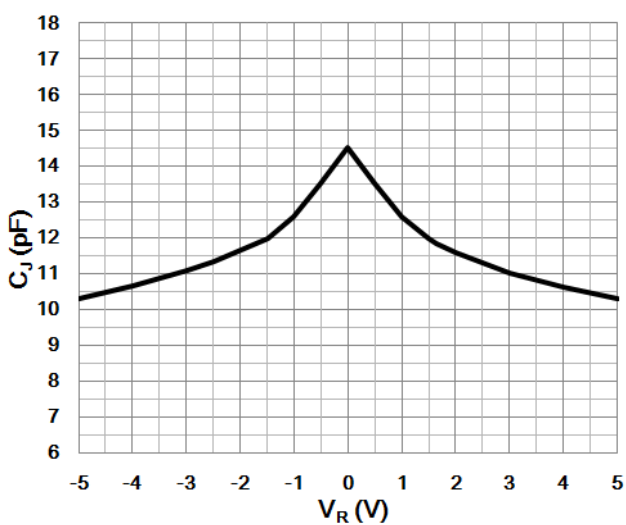
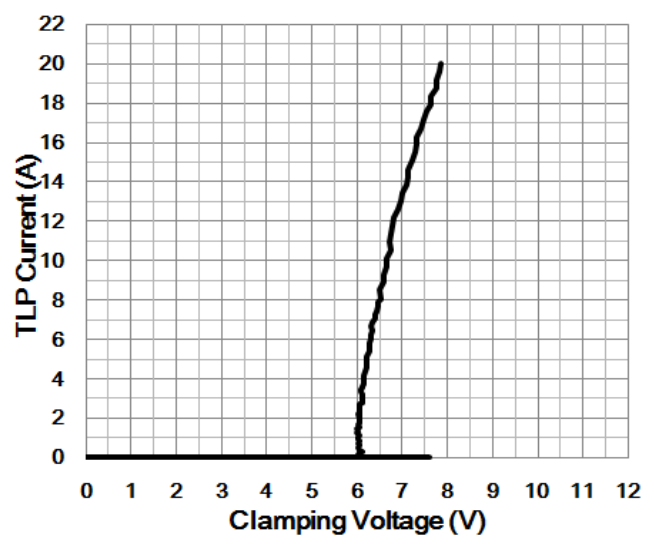
 Fig. 2 - TLP Clamping Voltage ( $t_{\text{period}} = 100\text{ns}$ ,  $t_r = 1\text{ns}$ )

## PACKAGE OUTLINE AND PART MARKING

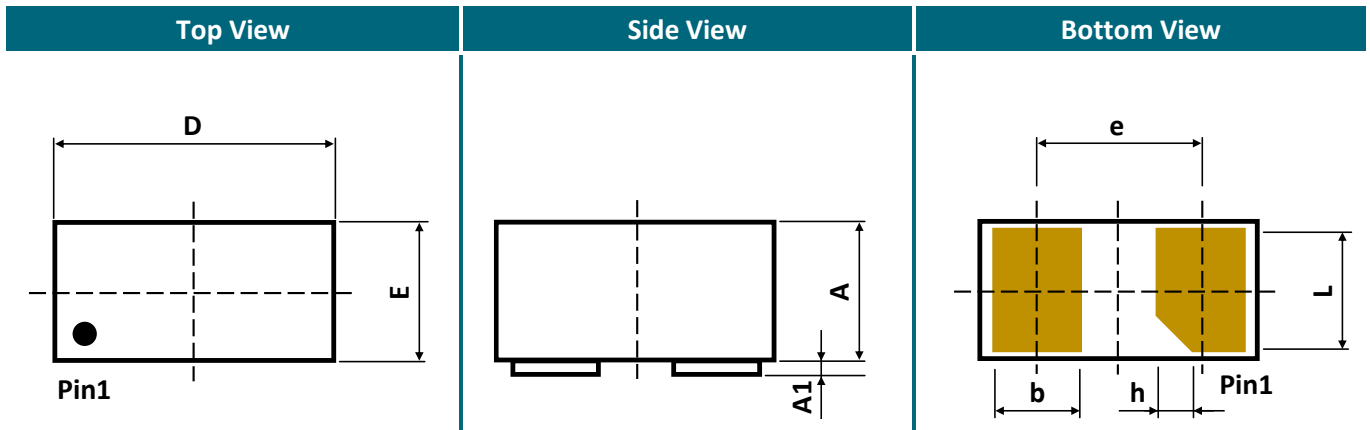

Sym	Millimeters (Min.)	Millimeters (Typ.)	Millimeters (Max.)
A	0.25	0.30	0.35
A1	0.00	0.02	0.05
b	0.13	0.18	0.24
D	0.55	0.60	0.65
E	0.25	0.30	0.35
e	0.35 BSC		
L	0.20	0.25	0.30
h	0.00	0.05	0.10



### Marking:

7: Product code  
UT8005B

### Note

- Package Outline Unit Description:**  
**BSC:** Basic. Represents theoretical exact dimension or dimension target.  
**MIN:** Minimum dimension specified  
**MAX:** Maximum dimension specified  
**REF:** Reference. Represents dimension for reference use only. This value is not a device specification.  
**TYP:** Typical. Provided as a general value. This value is not a device specification.
- Dimensions in Millimeters
- Drawing not to scale
- These dimensions do not include mold flash or protrusions. Mold flash or protrusions shall not exceed 0.15mm.

## ORDERING INFORMATION

Part Number	Package Type	Package Code	Part Marking	Parameter
UT8005BD42	DFN0603-2L	D42	7	7 = Product Code

Package Type	Vacuum Package			
DFN0603-2L	Packing	Reel 180mm (7")	Inner Box (3 Reels)	Carton (12 Boxes)
	Tape and Reel	12 000pcs	36 000pcs	432 000pcs

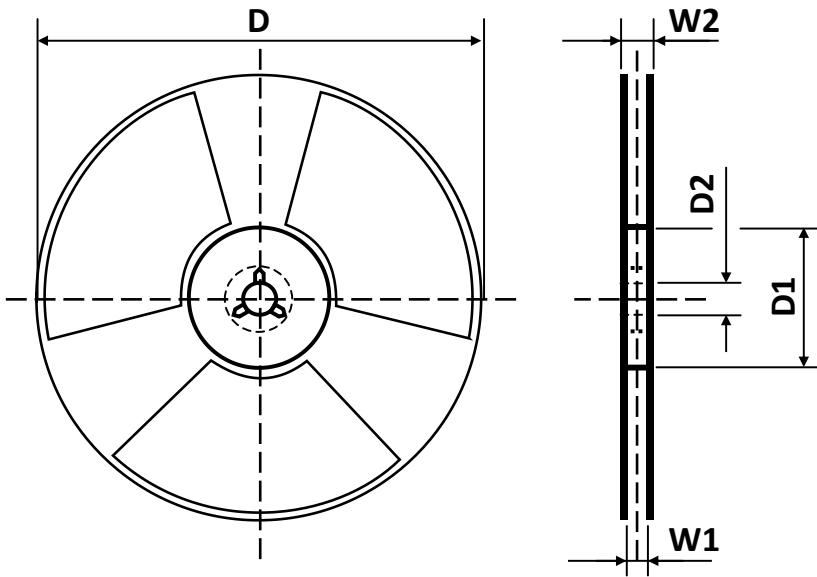
**REEL DIMENSIONS** ▲ All dimensions in mm

Tape Size	Reel Size	D	D1	D2	W1	W2
8mm	7 inch	$\varnothing 178.00$	54.40	13.00	9.50	12.30

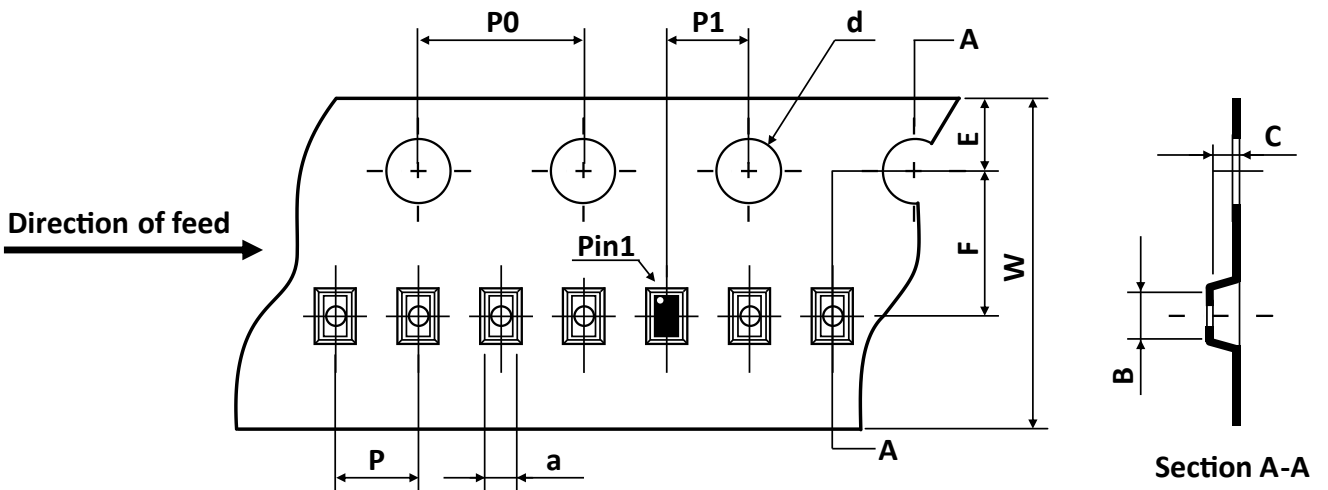
**TAPE DIMENSIONS** ▲ All dimensions in mm

Package	a	B	C	d	E	F	P0	P	P1	W
DFN0603-2L	0.41	0.70	0.38	1.50	1.75	3.50	4.00	2.00	2.00	8.00

Note: All dimensions meet EIA-481-D requirements.

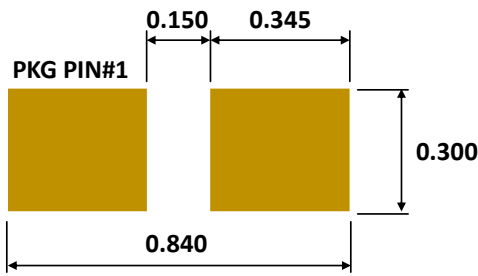
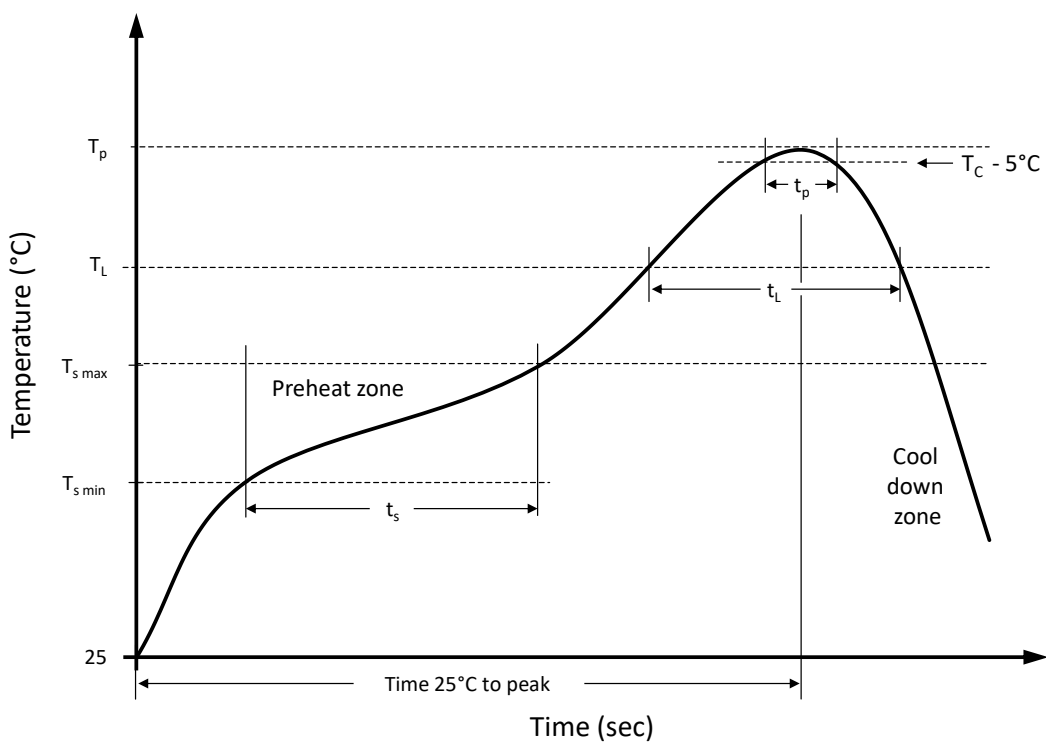
**RECOMMENDED PAD LAYOUT FOR DFN0603-2L ▲ All dimensions in mm**

**RECOMMENDED REFLOW SOLDERING PROFILE**

**Recommended reflow soldering conditions ▲ Refer to JEDEC J-STD-020E**

Profile Features		Sn-Pb Eutetic Assembly	Pb-Free Assembly
Preheat temperature min.	$T_{s \min}$	100 °C	150 °C
Preheat temperature max.	$T_{s \max}$	150 °C	200 °C
Preheat time $t_s$ from $T_{s \min}$ to $T_{s \max}$	$t_s$	120 seconds	120 seconds
Ramp-up rate ( $T_L$ to $T_p$ )		max. 3 °C/second	max. 3 °C/second
Liquidous temperature	$T_L$	183 °C	217 °C
Time $t_L$ maintained above $T_L$	$t_L$	150 seconds max.	150 seconds max.
Peak package body temperature	$T_p$	235°C	260°C
Timeframe of within 5°C below and up to max actual peak body temperature	$t_p$	20 seconds max.	30 seconds max.
Ramp-down rate ( $T_L$ to $T_p$ )		max. 6 °C/second	max. 6 °C/second
Time 25°C to peak temperature		max. 6 minutes	max. 8 minutes

## REVISION TABLE

Revision	Date	Status	Notes
001	01/10/2021	Initial release	Initial publication

## DISCLAIMER

Except for the written expressed warranties, MGT does not implicitly, by assumption or whatever else, warrant, under-take, promise any other warranty or guaranty for any MGT product.

All information and technical specifications made available by MGT are for guidance only and we reserve the right to change or modify them without prior notice. Unless expressly stated in writing by MGT, we reject any guarantees, obligations, or warranties.

All MGT products with the technical specifications described are suitable for use in certain applications. Operating, production, storage and environmental conditions can have a massive influence on the parameters mentioned in the data sheets, which cause the performance to vary over time.

It is subject to the user's duty of care to design and validate his products in such a way that appropriate measures are taken, such as protective circuits or redundant systems to ensure the safety standards required in the application.

MGT components are not designed or rated for use in life support, rescue, safety critical, military, or aerospace applications where failure or malfunction could result in property or environmental damage, serious injury or death. In the aforementioned cases, please contact us before using MGT products.

In principle, we reserve all rights and MGT's general terms and conditions apply. You can find them on our website [www.mgt.co.com](http://www.mgt.co.com).

## X-ON Electronics

Largest Supplier of Electrical and Electronic Components

*Click to view similar products for [ESD Suppressors / TVS Diodes](#) category:*

*Click to view products by [MGT Brightek](#) manufacturer:*

Other Similar products are found below :

[60KS200C](#) [D18V0L1B2LP-7B](#) [D5V0F4U5P5-7](#) [NTE4902](#) [P4KE27CA](#) [P6KE11CA](#) [P6KE8.2A](#) [SA60CA](#) [SA64CA](#) [SMBJ12CATR](#)  
[SMBJ33CATR](#) [SMBJ6.5A](#) [SMBJ8.0A](#) [ESD101-B1-02ELS E6327](#) [ESD112-B1-02EL E6327](#) [ESD7451N2T5G](#) [19180-510](#) [CPDT-5V0USP-](#)  
[HF](#) [3.0SMCJ33CA-F](#) [3.0SMCJ36A-F](#) [HSPC16701B02TP](#) [JANTX1N6126A](#) [D3V3Q1B2DLP3-7](#) [D55V0M1B2WS-7](#) [DRTR5V0U4SL-7](#)  
[SCM1293A-04SO](#) [ESD200-B1-CSP0201 E6327](#) [ESDAULC45-1BF4](#) [SM12-7](#) [CEN955 W/DATA](#) [VESD12A1A-HD1-GS08](#) [CPDQC5V0-HF](#)  
[D1213A-01LP4-7B](#) [ESD101-B1-02EL E6327](#) [AOZ8808DI-03](#) [5KP15A](#) [5KP48A](#) [5KP90A](#) [ESD3V3D7-TP](#) [15KPA36A-LF](#) [NTE4900](#)  
[P4KE56CA](#) [P4KE68A](#) [P4KE91CATR](#) [P6KE120A](#) [P6KE13CA](#) [P6KE43CA](#) [P6KE6.8CA](#) [P6KE8.2](#) [P6SMBJ20CA](#)