

THIS IS A C.A.D. GENERATED DRAWING
DO NOT MAKE MANUAL REVISIONS TO MASTER.



* UNLESS OTHERWISE SPECIFIED TOLERANCES
ON DECIMAL IS: ANGLE $\pm 1^\circ$
UNIT: MM .XX ± 0.05

BACKSHELL KIT INCLUDES:

- (2)BACKSHELL HALVES
- (2)4-40 THUMBSCREWS
- (2)HOUSING SCREWS
- (1)SET OF COMPRESSION INSERTS-VARIOUS SIZES FOR 9-37
DIAMETERS 4mm(.157"), 5mm(.167"), 7mm(.276"), 9mm(.354")
- (1)SET OF COMPRESSION INSERTS-VARIOUS SIZES FOR 50
DIAMETERS 11mm(.433"), 12.5mm(.492"), 14mm(.551"), 15mm(.591")

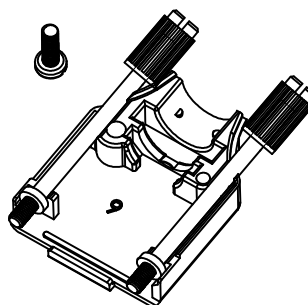
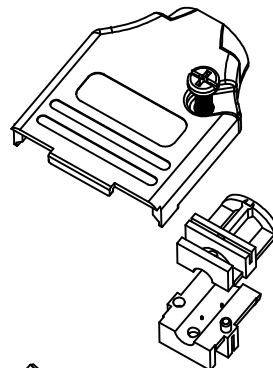
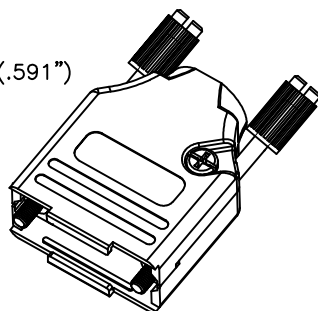
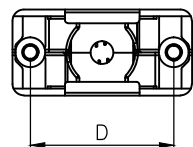
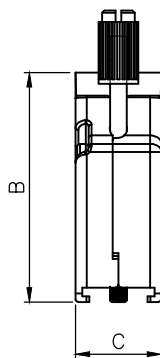
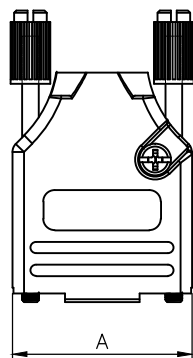

DIMENSIONS(mm/in)				
SIZE	A ± 0.02	B ± 0.02	C ± 0.02	D ± 0.01
9	31.20	39.90	15.00	24.99
	1.228	1.571	0.591	0.984
15	39.50	41.50	15.00	33.32
	1.555	1.634	0.591	1.312
25	53.40	48.60	15.00	47.04
	2.102	1.913	0.591	1.852
37	69.70	53.60	15.00	63.50
	2.744	2.110	0.591	2.500
50	67.50	54.00	18.70	61.00
	2.657	2.126	0.736	2.402

ORDERING INFORMATON:

SIZE	P/N - KITTED	PRODUCT CODE
9-WAY	6560-3105-01	MHDTZK-09-RA-PC-K
15-WAY	6560-3105-02	MHDTZK-15-RA-PC-K
25-WAY	6560-3105-03	MHDTZK-25-RA-PC-K
37-WAY	6560-3105-04	MHDTZK-37-RA-PC-K
50-WAY	6560-3105-05	MHDTZK-50-RA-PC-K

SIZE	P/N - BULK	PRODUCT CODE
9-WAY	6561-3105-01	MHDTZK-09-RA-PC
15-WAY	6561-3105-02	MHDTZK-15-RA-PC
25-WAY	6561-3105-03	MHDTZK-25-RA-PC
37-WAY	6561-3105-04	MHDTZK-37-RA-PC
50-WAY	6561-3105-05	MHDTZK-50-RA-PC

BACKSHELL MATERIAL: DIE-CAST ZINC ALLOY
 PLATING: NICKEL
 JACKSCREWS: STEEL:ZN PLATED WITH PLASTIC KNOB
 M3 HOODSCREWS: STEEL:ZN PLATED
 COMPRESSION INSERT: ABS,UL RECOGNIZED
 OPERATING TEMP: -40°C TO+120°C

THESE DRAWINGS AND SPECIFICATIONS ARE THE PROPERTY OF MH CONNECTORS AND SHALL NOT BE REPRODUCED, COPIED OR USED AS THE BASIS FOR THE MANUFACTURE OR SALE OF APPARATUS WITHOUT WRITTEN PERMISSION.

DRAWN Johnny	DATE 11-24-15
APPROVED Victor Lin	DATE 11-24-15



THIS SERIES FULLY CONFORMS TO THE EUROPEAN UNION DIRECTIVES 2002/95/EC AND 2002/96/EC FOR RoHS COMPLIANCY.



**MH CONNECTORS ,
DIVISION OF EDAC**

SCALE 1 : 1	SHEET OF 1 OF 1	REV: 7.0
----------------	--------------------	-------------

DRAWING No
MHDTZK-RA-PC

THIS IS A C.A.D. GENERATED DRAWING
DO NOT MAKE MANUAL REVISIONS TO MASTER.

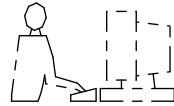

* UNLESS OTHERWISE SPECIFIED TOLERANCES
ON DECIMAL IS: ANGLE X.° ± 3' X.X' ± 1"
UNIT: MM
X. ± 0.30
X.X ± 0.25
X.XX ± 0.20
X.XXX ± 0.15

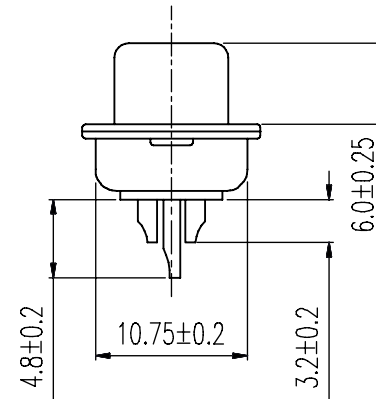
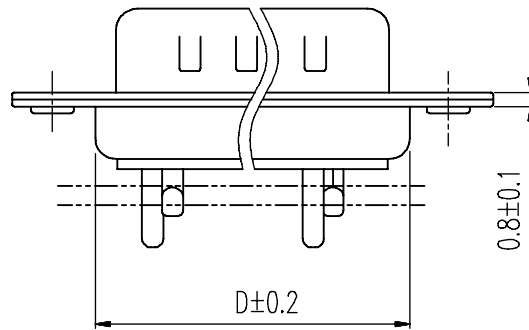
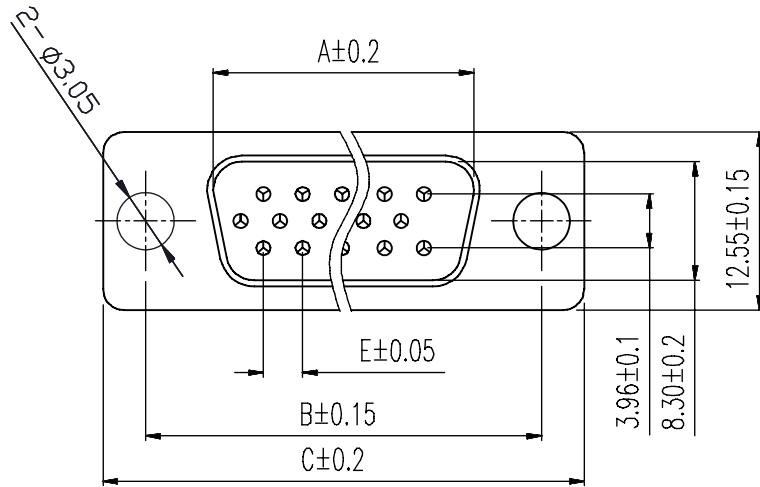

Order Codes:

Plug Connector Stamped & Formed

15-WAY	MHHDS-15-M-N-B-S
26-WAY	MHHDS-26-M-N-B-S
44-WAY	MHHDS-44-M-N-B-S
62-WAY	MHHDS-62-M-N-B-S

POS.	A	B	C	D	E
15	16.90	24.99	30.80	19.10	2.29
26	25.30	33.32	39.10	27.75	2.29
44	39.00	47.04	53.00	41.30	2.29
62	55.40	63.50	69.30	57.40	2.41

Remark:1.MATERIAL:

Plastic:PBT+30% G.F (UL94V-0) BLACK

Spcc shell:Spcc front shell is nickel plated back shell is nickel plated

THESE DRAWINGS AND SPECIFICATIONS ARE THE PROPERTY OF MH CONNECTORS AND SHALL NOT BE REPRODUCED, COPIED OR USED AS THE BASIS FOR THE MANUFACTURE OR SALE OF APPARATUS WITHOUT WRITTEN PERMISSION.

DRAWN
IVEN Ou DATE
08-18-22

APPROVED DATE

SCALE SHEET OF REV:
1 : 1 1 OF 1 3.0

DRAWING No
MHHDS-XX-M-N-B-S



THIS SERIES FULLY CONFORMS TO THE EUROPEAN UNION DIRECTIVES 2002/95/EC AND 2002/96/EC FOR RoHS COMPLIANCY.



MH CONNECTORS,
DIVISION OF EDAC

X-ON Electronics

Largest Supplier of Electrical and Electronic Components

Click to view similar products for [MH Connectors](#) manufacturer:

Other Similar products are found below :

[2801-0102-01](#) [2801-0102-02](#) [2801-0102-03](#) [2801-0102-04](#) [2801-0102-11-8](#) [2801-0102-12-8](#) [2801-0102-13-8](#) [6560-0139-12](#) [6560-0139-13](#)
[6560-0139-14](#) [CCOV-37SC-BLACK](#) [CCOV-9SC-MP](#) [DA25-PMJ8-R-K](#) [DA25-PMJ8-Y-K](#) [DA25-SMJ6-K](#) [DA25-SMJ8-B-K](#) [DA25-SMJ8-G-K](#) [DA25-SMJ8-R-K](#) [DA25-SMJ8-Y-K](#) [DA9-PMJ8-B-K](#) [DA9-SMJ8-B-K](#) [DA9-SMJ8-R-K](#) [DSSKM15L-DB15P-K](#) [DSSKM15L-DB15S-K](#)
[DSSKM25L-DB25P-K](#) [DSSKM25L-DB25S-K](#) [DSSKM9L-DB9S-K](#) [DSSKP15L-DB15S-K](#) [DSSKP25L-DB25S-K](#) [DSSKP9L-DB9P-K](#)
[DSSKP9L-DB9S-K](#) [DTZK15BKRAPCBK-K](#) [DTZK25BKRAPCBK-K](#) [DTZK9BKRAPCBK-K](#) [GA0909FFLGK-RC](#) [GA0909MFLGK-RC](#)
[GA1515MFLGK-RC](#) [GA1515MMLGK-RC](#) [GA2525FFLGK-RC](#) [GA2525MFLGK-RC](#) [GA2525MMLGK-RC](#) [MDS15S](#) [MDS25S](#) [MH3101-8821](#) [MH3101-CAT5E](#) [MH3101S-8821](#) [MH3101S-CAT5E](#) [MH3101S-CAT6](#) [MH3101S-CAT6A](#) [MHCDD3W3P4](#)