

Features

Wide Voltage Operation

- VCC = 1.7V to 5.5V

Operating Ambient Temperature: -40°C to +85°C

Internally Organized:

- HE24C02, 256 X 8 (2K bits)

- Two-wire Serial Interface

- Schmitt Trigger, Filtered Inputs for Noise Suppression

- Bidirectional Data Transfer Protocol

- 1 MHz (5V), 400 kHz (1.7V, 2.5V, 2.7V) Compatibility

- Write Protect Pin for Hardware Data Protection

- 8-byte Page (2K), 16-byte Page (4K, 8K, 16K) Write Modes

- Partial Page Writes Allowed

- Self-timed Write Cycle (5 ms max) High-reliability

- Endurance: 1 Million Write Cycles

- Data Retention: 100 Years

- 8-lead PDIP/SOP/TSSOP/MSOP, 8 PAD DFN and SOT23-5 Packages

General Description

The HE24C02 provides 2048 bits of serial electrically erasable and programmable read-only memory (EEPROM) organized as 256 words of 8 bits each. The device is optimized for use in many industrial and commercial applications where low-power and low-voltage operation are essential. The HE24C02 is available in space-saving 8-lead PDIP, 8-lead SOP, 8-lead TSSOP, 8-lead MSOP, 8 PAD DFN and SOT23-5 packages and is accessed via a two-wire serial interface.

Pin Configuration

Pin Name	Functions
A0-A2	Address Inputs
SDA	Serial Data
SCL	Serial Clock Input
WP	Write Protect
GND	Ground
VCC	Power Supply

8 - lead DFN

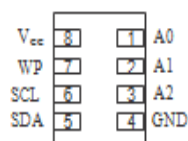

SOT23-5

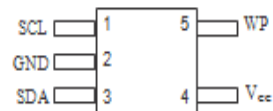

8 - lead PDIP

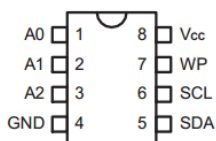

8 - lead SOP

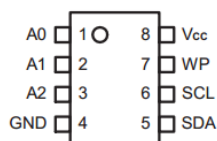

8 - lead TSSOP

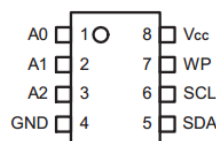

8 - lead MSOP

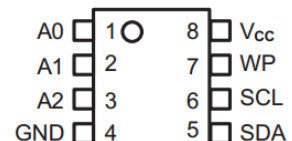

Block Diagram

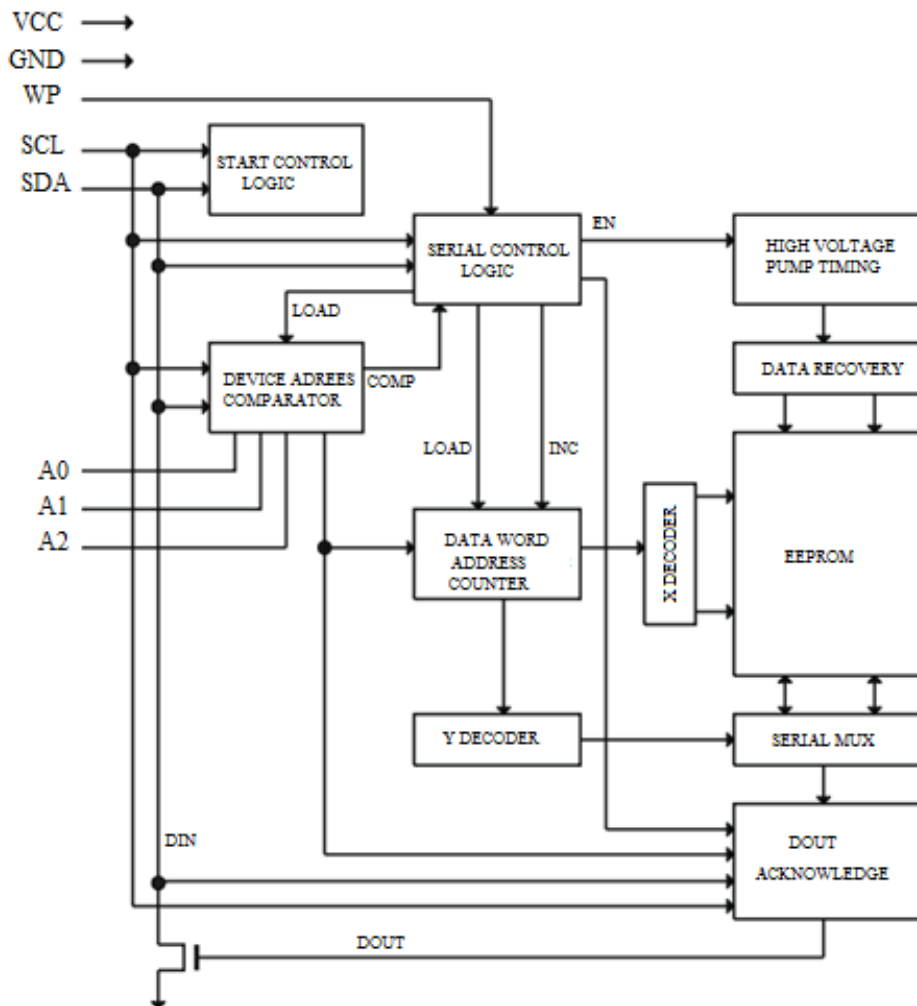

Pin Descriptions

DEVICE/PAGE ADDRESSES (A2, A1 and A0): The A2, A1 and A0 pins are device address inputs that are hard wired for the HE24C02.

SERIAL DATA (SDA): The SDA pin is bi-directional for serial data transfer. This pin is open-drain driven and may be wire-Read with any number of other open-drain or open-collector devices.

SERIAL CLOCK (SCL): The SCL input is used to positive edge clock data into each EEPROM device and negative edge clock data out of each device.

WRITE PROTECT (WP): The HE24C02 has a Write Protect pin that provides hardware data protection. The Write Protect pin allows normal read/write operations when connected to ground (GND). When the Write Protect pin is connected to VCC, the write protection feature is enabled and operates as shown in the following

Table 2:Write Protect

WP Pin Status	Part of the Array Protected
	HE24C02
At Vcc	Full(2K)Array
At GND	Normal Read/Write Operations

Memory Organization

HE24C02, 2K SERIAL EEPROM: Internally organized with 32 pages of 8 bytes each, the 2K requires an 8-bit data word address for random word addressing.

Device Operation

CLOCK and DATA TRANSITIONS: The SDA pin is normally pulled high with an external device. Data on the SDA pin may change only during SCL low time periods (see to Figure 1 on page 4). Data changes during SCL high periods will indicate a start or stop condition as defined below.

START CONDITION: A high-to-low transition of SDA with SCL high is a start condition which must precede any other command (see to Figure 2 on page 4).

STOP CONDITION: A low-to-high transition of SDA with SCL high is a stop condition. After a read sequence, the stop command will place the EEPROM in a standby power mode (see Figure 2 on page 4).

ACKNOWLEDGE: All addresses and data words are serially transmitted to and from the EEPROM in 8-bit words. The EEPROM sends a "0" to acknowledge that it has received each word. This happens during the ninth clock cycle.

STANDBY MODE: The HE24C02 features a low-power standby mode which is enabled: (a) upon power-up and (b) after the receipt of the STOP bit and the completion of any internal operations.

MEMORY RESET: After an interruption in protocol, power loss or system reset, any two-wire part can be reset by following these steps:

1. Clock up to 9 cycles.
2. Look for SDA high in each cycle while SCL is high.
3. Create a start condition.

Figure 1: Data Validity

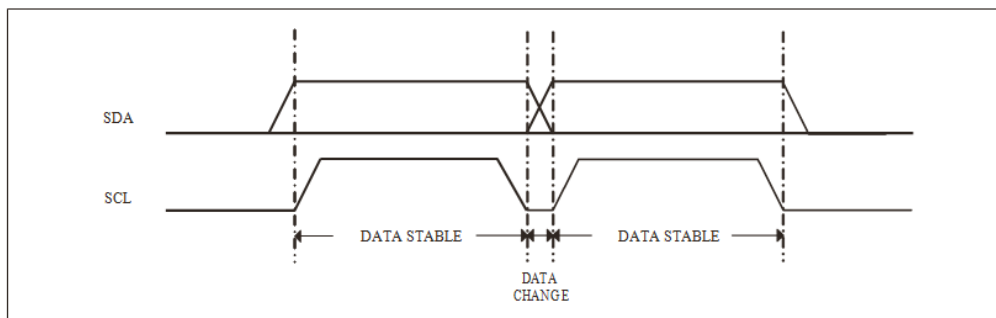

Figure 2: Start and Stop Definition

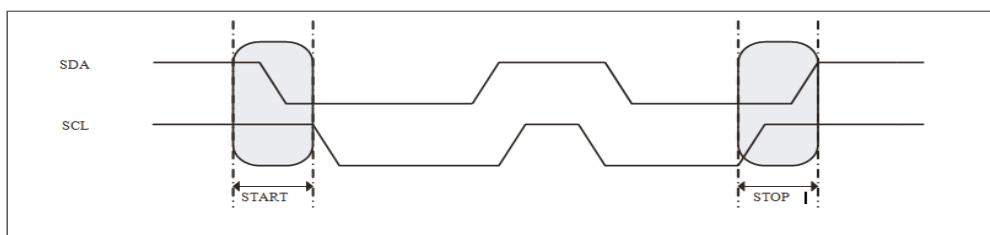
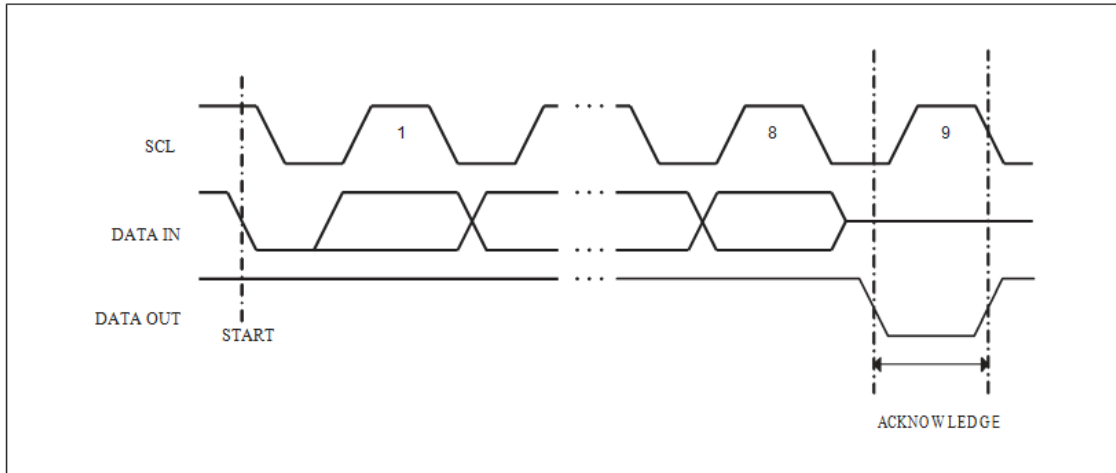



Figure 3: Output Acknowledge



Device Addressing

The 2K EEPROM device requires an 8-bit device address word following a start condition to enable the chip for a read or write operation (see to Figure 4 on page 7).

The device address word consists of a mandatory "1", "0" sequence for the first four most significant bits as shown. This is common to all the Serial EEPROM devices.

The next 3 bits are the A2, A1 and A0 device address bits for the 2K EEPROM. These 3 bits must compare to their corresponding hardwired input pins.

The eighth bit of the device address is the read/write operation select bit. A read operation is initiated if this bit is high and a write operation is initiated if this bit is low.

Upon a compare of the device address, the EEPROM will output a "0". If a compare is not made, the chip will return to a standby state.

Write Operations

BYTE WRITE: A write operation requires an 8-bit data word address following the device address word and acknowledgment. Upon receipt of this address, the EEPROM will again respond with a "0" and then clock in the first 8-bit data word. Following receipt of the 8-bit data word, the EEPROM will output a "0" and the addressing device, such as a microcontroller, must terminate the write sequence with a stop condition. At this time the EEPROM enters an internally timed write cycle, t_{WR} , to the nonvolatile memory. All inputs are disabled during this write cycle and the EEPROM will not respond until the write is complete (see Figure 5 on page 7).

PAGE WRITE: The 2K EEPROM is capable of an 8-byte page write.

A page write is initiated the same as a byte write, but the microcontroller does not send a stop condition after the first data word is clocked in. Instead, after the EEPROM acknowledges receipt of the first data word, the microcontroller can transmit up to seven (2K) more data words. The EEPROM will respond with a "0" after each data word received. The microcontroller must terminate the page write sequence with a stop condition (see Figure 6 on page 7).

The data word address lower three (2K) bits are internally incremented following the receipt of each data word. The higher data word address bits are not incremented, retaining the memory page row location. When the word address, internally generated, reaches the page boundary, the following byte is placed at the beginning of the same page. If more than eight (2K) data words are transmitted to the EEPROM, the data word address will "roll over" and previous data will be overwritten.

ACKNOWLEDGE POLLING: Once the internally timed write cycle has started and the EEPROM inputs are disabled, acknowledge polling can be initiated. This involves sending a start condition followed by the device address word. The read/write bit is representative of the operation desired. Only if the internal write cycle has completed will the EEPROM respond with a "0", allowing the read or write sequence to continue.

Read Operations

Read operations are initiated the same way as write operations with the exception that the read/write select bit in the device address word is set to "1". There are three read operations: current address read, random address read and sequential read.

CURRENT ADDRESS READ: The internal data word address counter maintains the last accessed address, and incremented by one.*This address stays valid between operations as long as the chip power is maintained. The address "roll over" during read is from the last byte of the last memory page to the first byte of the first page. The address "roll over" during write is from the last byte of the current page to the first byte of the same page.

Once the device address with the read/write select bit set to "1" is clocked in and acknowledged by the EEPROM, the current address data word is serially clocked out. The microcontroller does not respond with an input "0" but does generate a following stop condition (see Figure 7 on page 8).

Read Operations

RANDOM READ: A random read requires a "dummy" byte write sequence to load in the data word address. Once the device address word and data word address are clocked in and acknowledged by the EEPROM, the microcontroller must generate another start condition. The microcontroller now initiates a current address read by sending a device address with the read/write select bit high. The EEPROM acknowledges the device address and serially clocks out the data word. The microcontroller does not respond with a "0" but does generate a following stop condition (see Figure 8 on page 8).

SEQUENTIAL READ: Sequential reads are initiated by either a current address read or a random address read. After the microcontroller receives a data word, it responds with an acknowledge. As long as the EEPROM receives an acknowledge, it will continue to increment the data word address and serially clock out sequential data words. When the memory address limit is reached, the data word address will "roll over" and the sequential read will continue. The sequential read operation is terminated when the microcontroller does not respond with a "0" but does generate a following stop condition (see Figure 9 on page 8).

Figure 4: Device Address

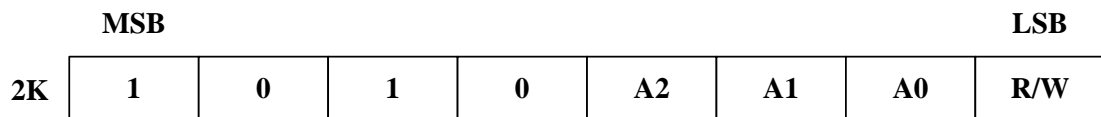

Figure 5: Byte Write

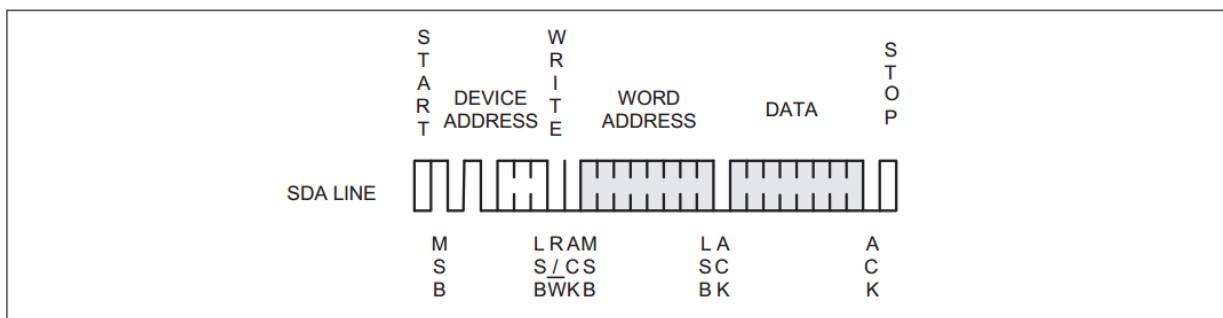

Figure 6: Page Write

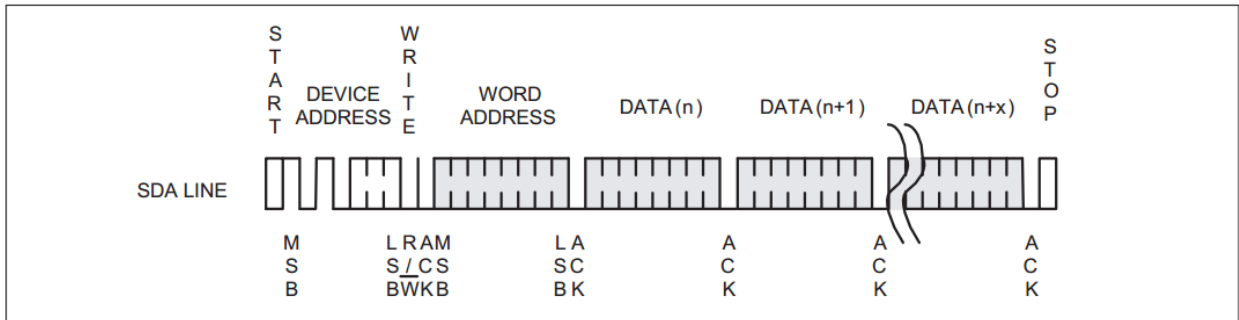

Figure 7: Current Address Read

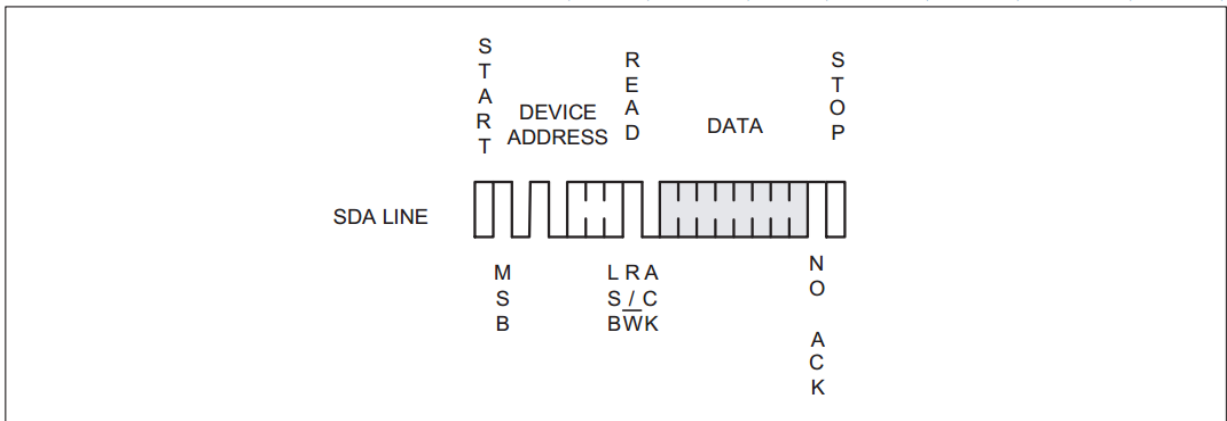

Figure 8: Random Read

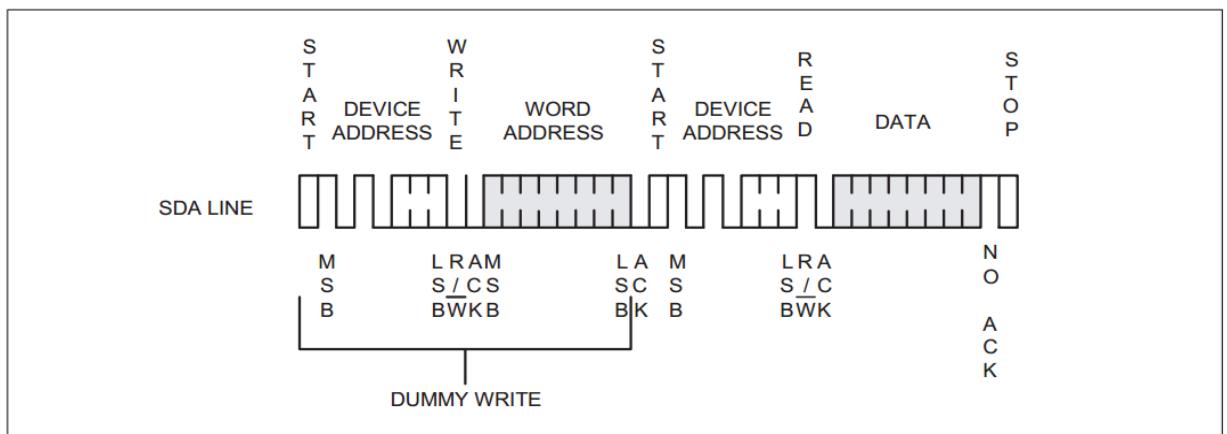
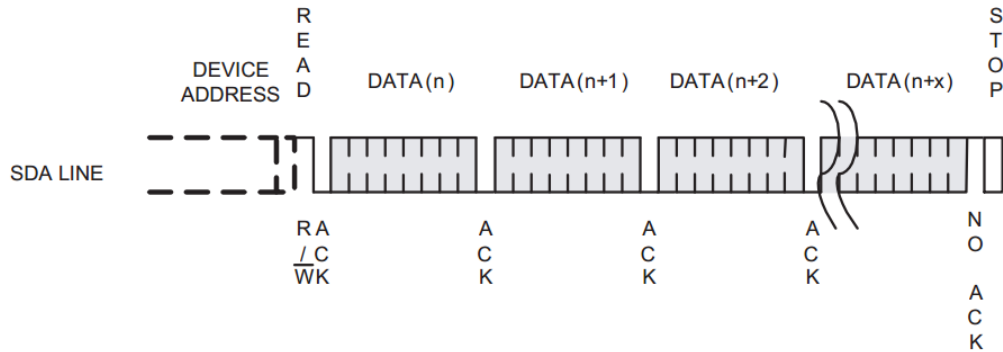

Figure 9: Sequential Read



Electrical Characteristics

Absolute Maximum Stress Ratings

- DC Supply Voltage.....-0.3V to +6.5V
- Input / Output VoltageGND-0.3V to VCC+0.3V
- Operating Ambient Temperature -40°C to +85°C
- Storage Temperature -65°C to +150°C

Comments

Stresses above those listed under "Absolute Maximum Ratings" may cause permanent damage to this device. These are stress ratings only. Functional operation of this device at these or any other conditions above those indicated in the operational sections of this specification is not implied or intended. Exposure to the absolute maximum rating conditions for extended periods may affect device reliability.

DC Electrical Characteristics

Applicable over recommended operating range from: TA = -40°C to +85°C, VCC = +1.7V to +5.5V (unless otherwise noted)

Parameter	Symbol	Min.	Typ.	Max.	Unit	Condition
Supply Voltage	Vcc	1.7	—	5.5	V	
Supply Current VCC = 5.0V	ICC1	—	0.4	1.0	mA	READ at 400KHz
Supply Current VCC = 5.0V	ICC2	—	2.0	3.0	mA	WRITE at 400KHz
Standby Current	ISB	—	—	3.0	µA	VIN=VCC or GND
Input Leakage Current	ILI	—	—	3.0	µA	VIN=VCC or GND
Output Leakage Current	ILO	—	0.05	3.0	µA	VOUT=VCC or GND
Input Low Level	VIL1	-0.3	—	Vcc*0.3	V	Vcc=1.8V to 5.5V
Input High Level	VIH1	Vcc*0.7	—	Vcc+0.3	V	Vcc=1.8V to 5.5V
Input Low Level	VIL2	-0.3	—	Vcc*0.2	V	Vcc=1.7V
Input High Level	VIH2	Vcc*0.7	—	Vcc+0.3	V	Vcc=1.7V
Output Low Level VCC =5.0V	VOL3	—	—	0.4	V	IOL=3.0mA
Output Low Level VCC =3.0V	VOL2	—	—	0.4	V	IOL=2.1mA
Output Low Level VCC =1.7V	VOL1	—	—	0.2	V	IOL=0.15mA

Pin Capacitance

Applicable over recommended operating range from $T_A = 25^\circ\text{C}$, $f = 1.0\text{ MHz}$, $V_{CC} = +1.7\text{V}$

Parameter	Symbol	Min.	Typ.	Max.	Unit	Condition
Input/Output Capacitance (SDA)	CI/O	-	-	8	pF	VI/O = 0V
Input Capacitance (A0, A1, A2, SCL)	CIN	-	-	6	pF	VIN = 0V

AC Electrical Characteristics

Parameter	Symbol	1.7v < Vcc < 2.5v			2.5v < Vcc < 5.5v			Units
		Min.	Typ.	Max.	Min.	Typ.	Max.	
Clock Frequency, SCL	fSCL	-	-	400	-	-	1000	KHz
Clock Pulse Width Low	tLOW	1.2	-	-	0.6	-	-	us
Clock Pulse Width High	tHIGH	0.6	-	-	0.4	-	-	us
Noise Suppression Time	tI	-	-	50	-	-	40	ns
Clock Low to Data Out Valid	tAA	0.05	-	0.9	0.05	-	0.55	us
Time the bus must be free before a new transmission can start	tBUF	1.2	-	-	0.5	-	-	us
Start Hold Time	tHD.STA	0.6	-	-	0.25	-	-	us
Start Setup Time	tSU.STA	0.6	-	-	0.25	-	-	us
Data In Hold Time	tHD.DAT	0	-	-	0	-	-	us
Data In Setup Time	tSU.DAT	100	-	-	100	-	-	ns
Inputs Rise Time(1)	tR	-	-	0.3	-	-	0.3	us
Inputs Fall Time(1)	tF	-	-	300	-	-	100	ns
Stop Setup Time	tSU.STO	0.6	-	-	0.25	-	-	us
Data Out Hold Time	tDH	50	-	-	50	-	-	ns
Write Cycle Time	tWR	-	1.5	5	-	1.5	5	ms
5.0V, 25°C, Byte Mode	Endurance	1M	-	-	-	-	-	Write Cycles

Bus Timing

Figure 10: SCL: Serial Clock, SDA: Serial Data I/O

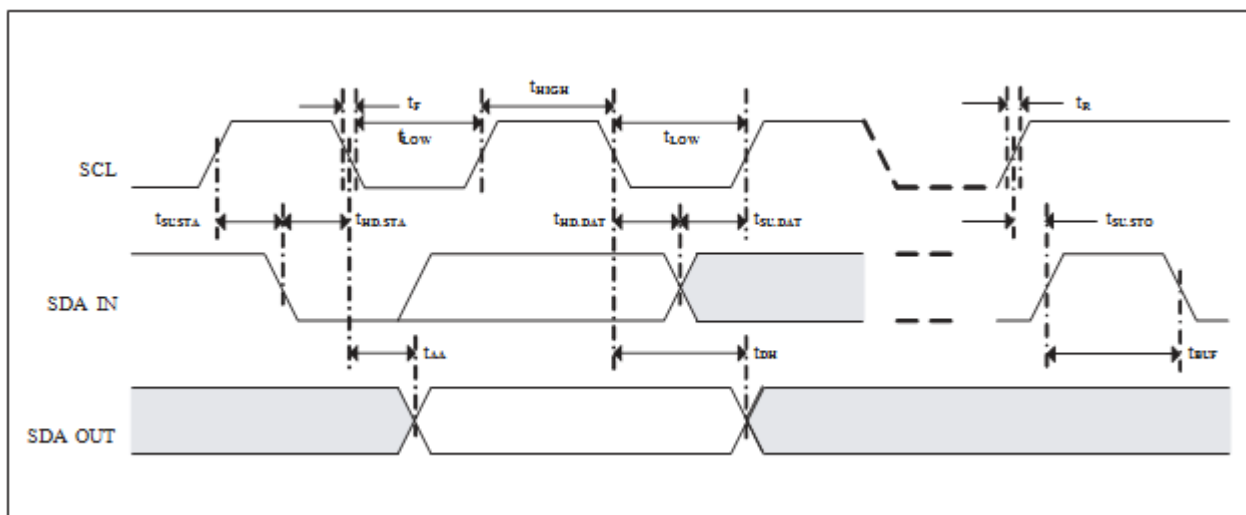

Write Cycle Timing

Figure 11: SCL: Serial Clock, SDA: Serial Data I/O

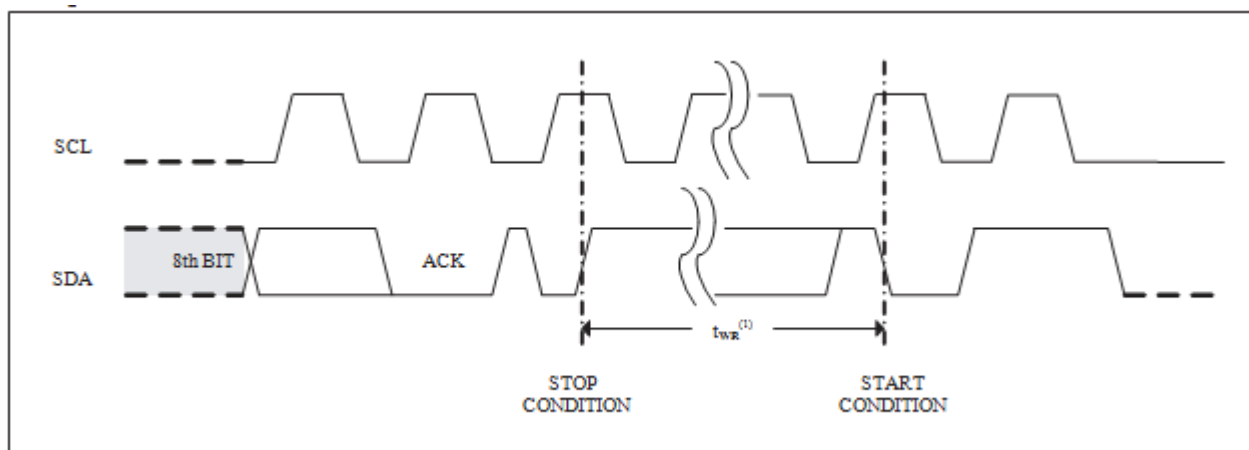

Note:

1. The write cycle time t_{WR} is the time from a valid stop condition of a write sequence to the end of the internal clear/write cycle.

DIP8

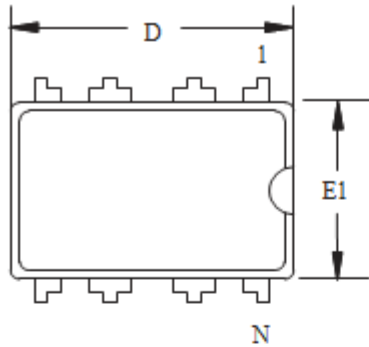

Top View

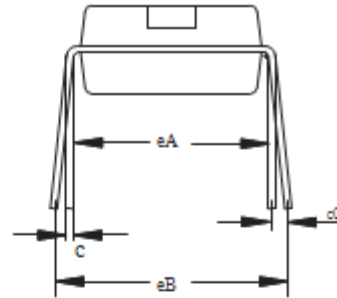

End View

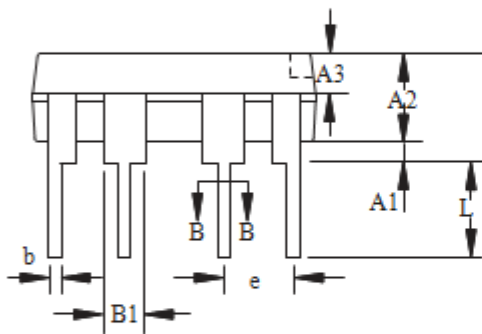

Side View

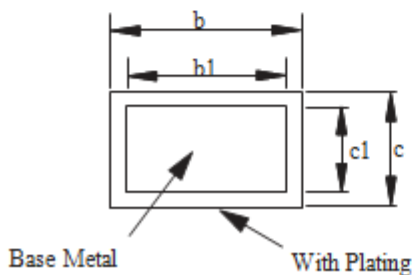

Section B-B

COMMON DIMENSIONS
(Unit of Measure = mm)

SYMBOL	MIN	MAX
A	3.60	4.00
A1	0.51	-
A2	3.10	3.50
A3	1.50	1.70
b	0.44	0.53
b1	0.43	0.48
B	1.52 BSC	
c	0.25	0.31
c1	0.24	0.26
D	9.05	9.45
E1	6.15	6.55
e	2.54 BSC	
eA	7.62 BSC	
eB	7.62	9.50
eC	0	0.94
L	3.00	-

SOP8

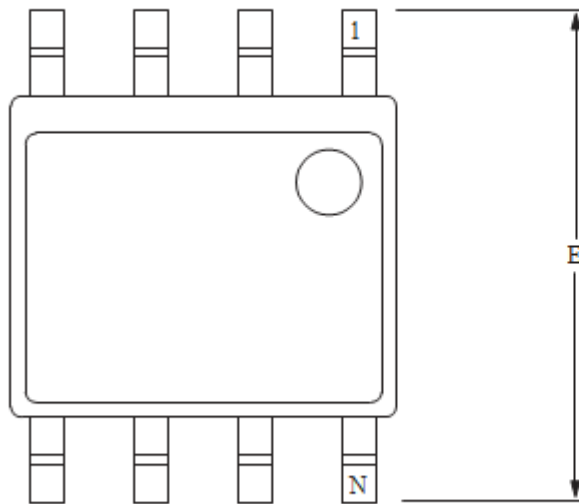

Top View

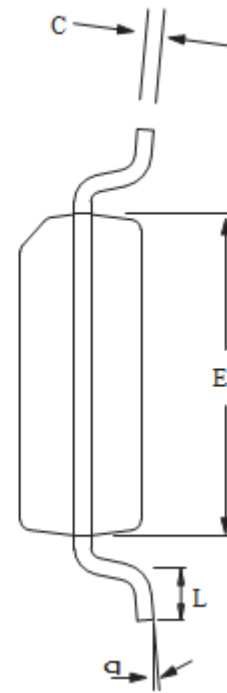

End View

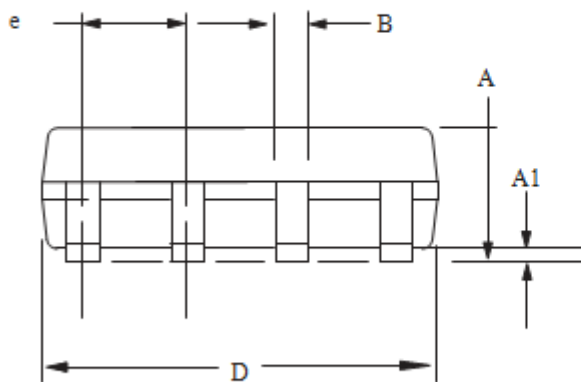

Side View

COMMON DIMENSIONS (Unit of Measure = mm)

SYMBOL	MIN	MAX
A	1.35	1.75
A1	0.10	0.25
b	0.31	0.51
C	0.17	0.25
D	4.70	5.10
E1	3.80	4.00
E	5.79	6.20
e	1.27 BSC	
L	0.40	1.27
φ	0°	8°

TSSOP8

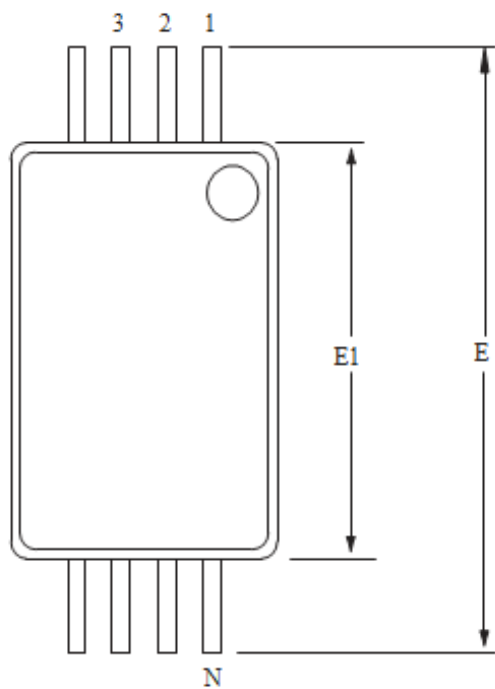

Top View

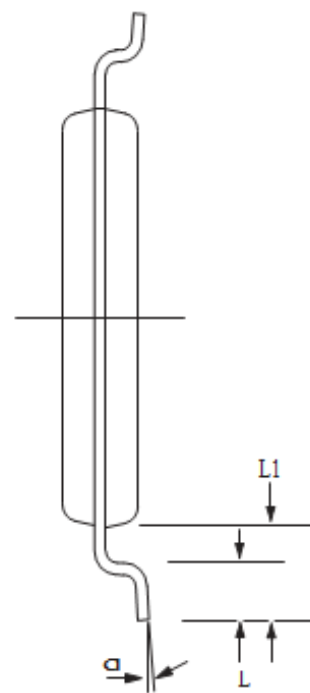

End View

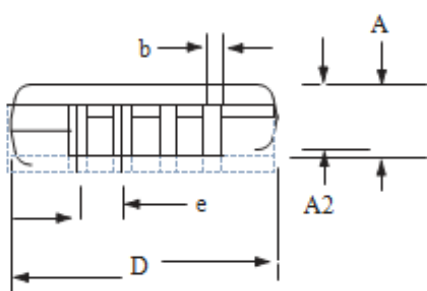

Side View

COMMON DIMENSIONS

(Unit of Measure = mm)

SYMBOL	MIN	MAX
D	2.80	3.20
E	6.20	6.60
E1	4.20	4.60
A	-	1.20
A2	0.80	1.15
b	0.19	0.30
e	0.65 BSC	
L	0.45	0.75
L1	1.00 BSC	
α	0°	8°

MSOP8

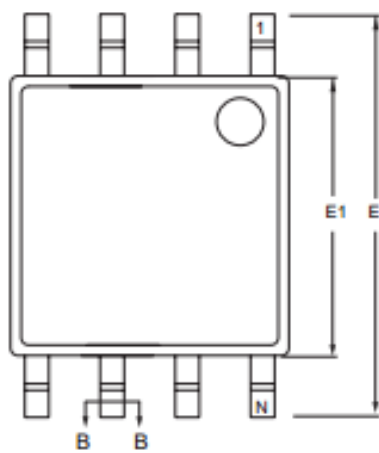

Top View

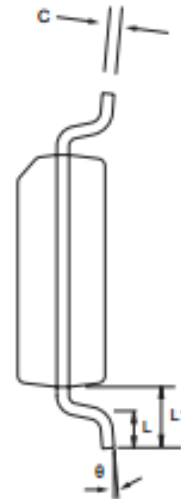

End View

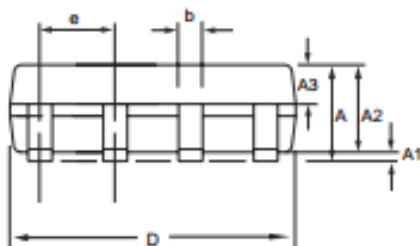

Side View

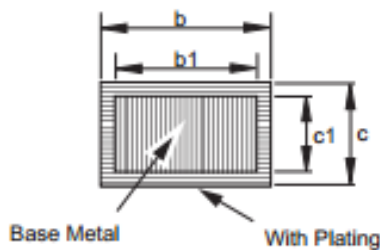

Section B-B

COMMON DIMENSIONS
(Unit of Measure = mm)

SYMBOL	MIN	MAX
A	-	1.10
A1	0.05	0.15
A2	0.75	0.95
A3	0.30	0.40
b	0.29	0.38
b1	0.28	0.33
c	0.15	0.20
c1	0.14	0.16
D	2.90	3.10
E	4.70	5.10
E1	2.90	3.10
e	0.65 BSC	
L	0.40	0.70
L1	0.95 BSC	
e	0°	8°

DFN

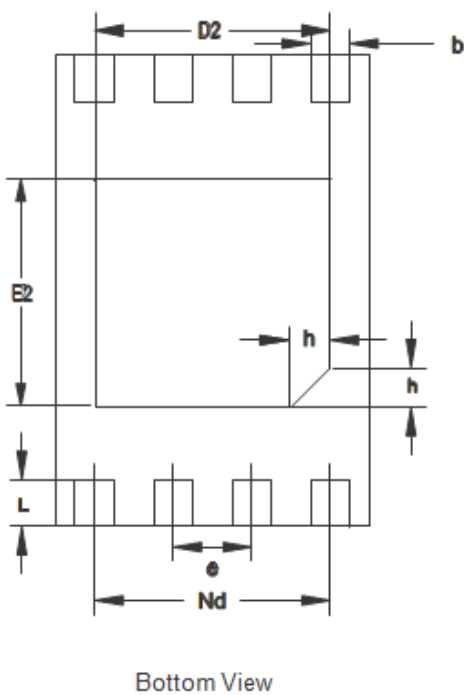
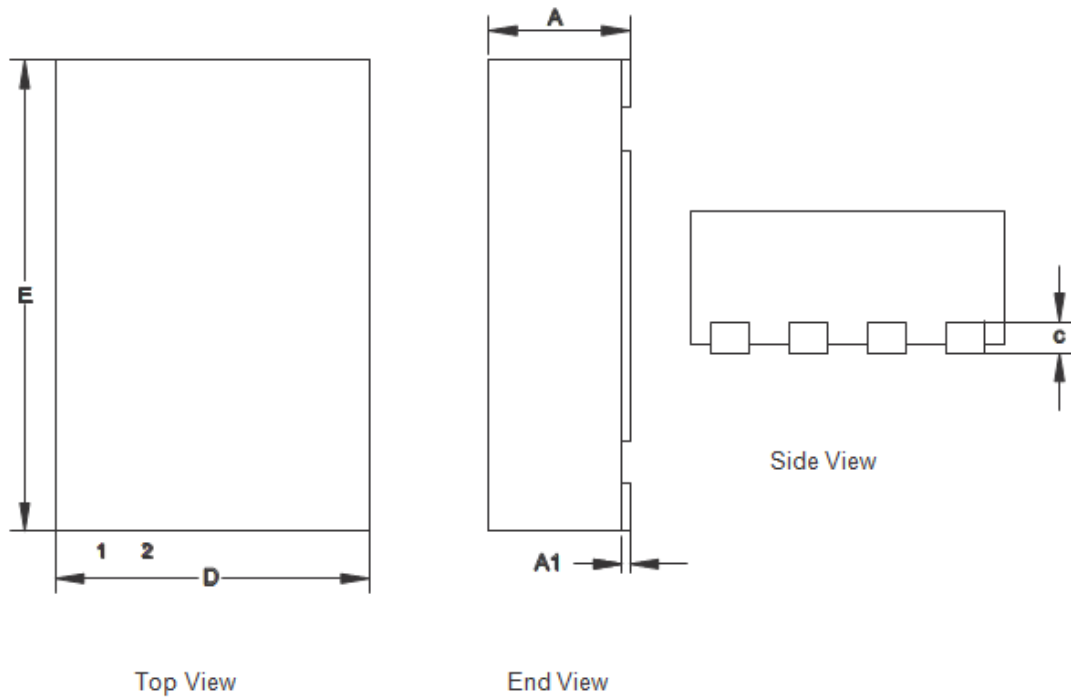

COMMON DIMENSIONS
(Unit of Measure = mm)

SYMBOL	MIN	MAX
A	0.70	0.80
A1	-	0.05
b	0.18	0.30
c	0.18	0.25
D	1.90	2.10
D2	1.50 REF	
e	0.50 BSC	
Nd	1.50 BSC	
E	2.90	3.10
E2	1.60 BSC	
L	0.30	0.50
h	0.20	0.30

SOT23-5

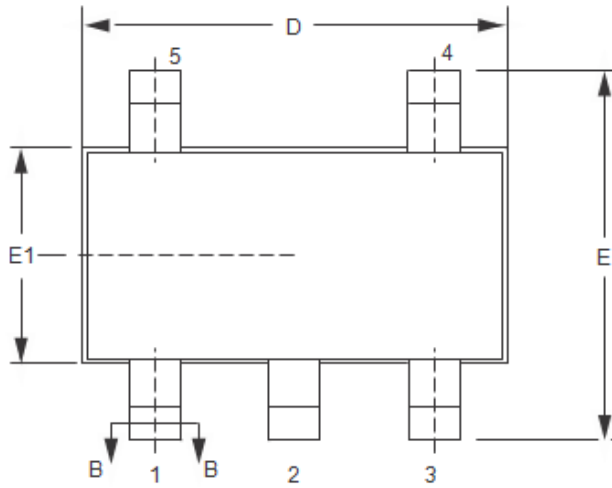

Top View

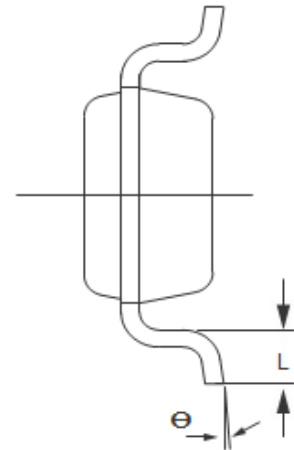

End View

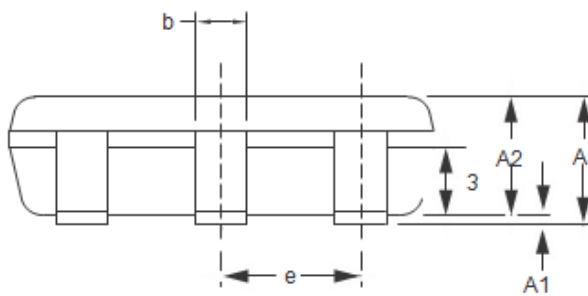

Side View

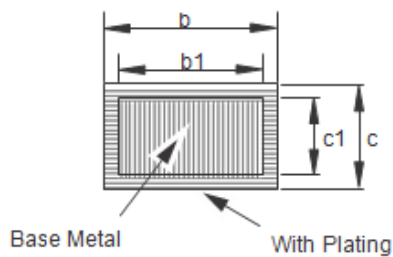

Section B-B

COMMON DIMENSIONS (Unit of Measure = mm)

SYMBOL	MIN	MAX
A	1.05	1.30
A1	0	0.10
A2	1.00	1.20
A3	0.55	0.75
b	0.30	0.50
b1	0.33	0.38
c	0.10	0.21
c1	0.14	0.16
D	2.72	3.12
E	2.60	3.00
E1	1.40	1.80
e	0.95 BSC	
L	0.30	0.60
θ	0°	8°



Order Information

HE 24C 02 XX X

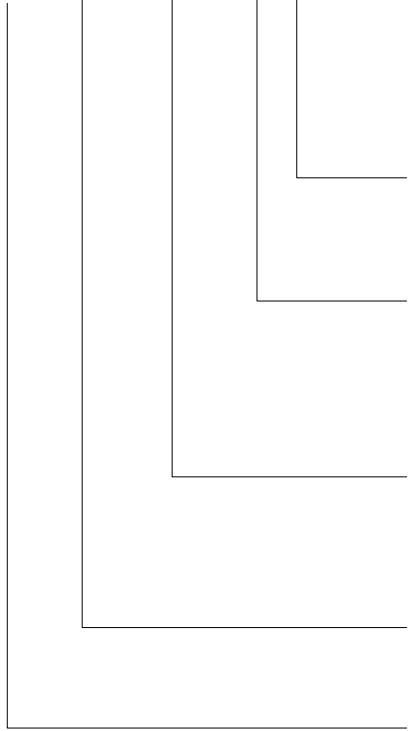

Pin Number:
H:8 pin E:5 pin D:4 pin

Package Type
 TS:TSSOP DFN:DFN
 SO:SOP PD:PDIP
 D23:SOT23-5 MS:MSOP

Density
 02:2Kbits 04:4Kbits 08:8Kbits
 16:16Kbits 32:32Kbits 64:64Kbits
 128:128Kbits 256:256Kbits 512:512Kbits

Product Family
24C:Two-wire EEPROM

Internal serial number

X-ON Electronics

Largest Supplier of Electrical and Electronic Components

Click to view similar products for [EEPROM](#) category:

Click to view products by [MIC](#) manufacturer:

Other Similar products are found below :

[M29F040-70K6](#) [718278CB](#) [718620G](#) [AT28C256-15PU-ND](#) [AT88SC6416CRF-MR1](#) [444358RB](#) [444362FB](#) [BR93C46-WMN6TP](#) [BR93C46-WMN7TP](#) [442652G](#) [701986CB](#) [TC58DVM92A5TA00](#) [TC58NVG0S3HBAI4](#) [X24645S8](#) [X2212P](#) [RM24C32C-LSNI-B](#) [5962-8751413XA](#) [TC58BVG0S3HBAI4](#) [TH58NYG3S0HBAI6](#) [CAT25320YIGT-KK](#) [CAT25320DWF](#) [TC58BYG0S3HBAI6](#) [LE24C162-R-E](#) [5962-8751417YA](#) [5962-8751409YA](#) [CAT25M01LI-G](#) [DS28E11P+](#) [BR9016AF-WE2](#) [LE2464DXATBG](#) [CAS93C66VP2I-GT3](#) [DS28E25+T](#) [DS28EL15Q+T](#) [M95320-DFDW6TP](#) [DS28E05GB+T](#) [AT25320B-SSPDGV-T](#) [BL24C128A-CSRC](#) [BL24SA128B-CSRC](#) [24FC16T-I/OT](#) [M24C02-DRMN3TPK](#) [M24C04-FMC5TG](#) [M24C16-DRMN3TPK](#) [M24C64-DFMN6TP](#) [M24C64-FCS6TPK](#) [34AA02-EMS](#) [M95080-RMC6TG](#) [M95128-DFCS6TP/K](#) [M95128-DFDW6TP](#) [M95256-DFMN6TP](#) [M95320-RDW6TP](#) [M95640-RDW6TP](#)