



## Ordering Information

Part Number	Junction Temperature Range	Package <sup>(1)</sup>
MIC3205YML	-40°C to +125°C	10-Pin 3mm x 3mm MLF

### Note:

1. MLF is a GREEN RoHS-compliant package. Lead finish is NiPdAu. Mold compound is Halogen Free.

## Pin Configuration

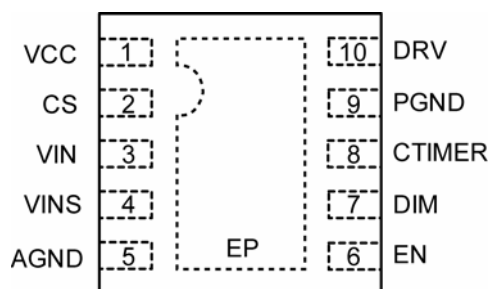

10-Pin 3mm x 3mm MLF (ML)  
Top View

## Pin Description

Pin Number	Pin Name	Pin Function
1	VCC	Voltage Regulator Output. The VCC pin is the output of a linear regulator powered from VIN, which supplies power to the internal circuitry. A 4.7µF ceramic capacitor is recommended for bypassing. Place it as close as possible to the VCC and AGND pins. Do not connect to an external load.
2	CS	Current Sense Input. Negative input to the current sense comparator. Connect an external sense resistor to set the LED current. Connect the current sense resistor as close as possible to the chip.
3	VIN	Input Power Supply. VIN is the input supply pin to the internal circuitry. Due to high frequency switching noise, a 10µF ceramic capacitor is recommended for bypassing and should be placed as close as possible to the VIN and PGND pins. See <a href="#">“PCB Layout Guidelines.”</a>
4	VINS	VIN Sense. Positive input to the current sense comparator. Connect as close as possible to the current sense resistor.
5	AGND	Analog Ground. Ground for all internal low-power circuitry.
6	EN	Enable Input. Logic high (greater than 2V) powers up the regulator. A logic low (less than 0.4V) powers down the regulator and reduces the supply current of the device to less than 2µA. A logic low pulls down the DRV pin turning off the external MOSFET. Do not drive the EN pin above VIN. Do not leave floating.
7	DIM	PWM Dimming Input. A PWM input can be used to control the brightness of the LED. Logic high (greater than 2V) enables the output. Logic low (less than 0.4V) disables the output regardless of the EN state. Do not drive the DIM pin above VIN. Do not leave floating.
8	CTIMER	Timer Capacitor. A capacitor is required from CTIMER to ground sets the target switching frequency using the equation $C_{TIMER} = 2.22 \cdot 10^{-4} / F_{SW}$
9	PGND	Power Ground. Ground for the power MOSFET gate driver. The current loop for the power ground should be as small as possible and separate from the analog ground loop. See <a href="#">“PCB Layout Recommendations.”</a>
10	DRV	Gate Drive Output. Connect to the gate of an external N-channel MOSFET. The drain of the external MOSFET connects directly to the inductor and provides the switching current necessary to operate in hysteretic mode.
EP	ePAD	Exposed Pad. Must be connected to a GND plane for best thermal performance.

**Absolute Maximum Ratings**<sup>(1)</sup>

$V_{IN}$ to PGND	-0.3V to +42V
$V_{INS}$ to PGND	-0.3V to ( $V_{IN}+0.3V$ )
$V_{CC}$ to PGND	-0.3V to +6.0V
CS to PGND	-0.3V to ( $V_{IN} + 0.3V$ )
EN to AGND	-0.3V to ( $V_{IN} + 0.3V$ )
DIM to AGND	-0.3V to ( $V_{IN} + 0.3V$ )
CTIMER to AGND	-0.3V to ( $V_{CC} + 0.3V$ )
DRV to PGND	-0.3V to ( $V_{CC} + 0.3V$ )
PGND to AGND	-0.3V to + 0.3V
Junction Temperature	150°C
Storage Temperature Range	-60°C to +150°C
Lead Temperature (Soldering, 10sec)	260°C
<b>ESD Ratings</b> <sup>(3)</sup>	
HBM	1.5kV
MM	200V

**Operating Ratings**<sup>(2)</sup>

Supply Voltage ( $V_{IN}$ )	4.5V to 40V
Enable Voltage ( $V_{EN}$ )	0V to $V_{IN}$
Dimming Voltage ( $V_{DIM}$ )	0V to $V_{IN}$
Junction Temperature ( $T_J$ )	-40°C to +125°C
<b>Junction Thermal Resistance</b>	
10-pin 3x3 MLF ( $\theta_{JA}$ )	60.7°C/W
10-pin 3x3 MLF ( $\theta_{JC}$ )	28.7°C/W

**Electrical Characteristics**<sup>(4)</sup>

$V_{IN} = V_{EN} = V_{DIM} = 12V$ ;  $C_{VCC} = 4.7\mu F$ ;  $T_J = 25^\circ C$ ; **bold** values indicate  $-40^\circ C \leq T_J \leq +125^\circ C$ , unless noted.

Symbol	Parameter	Condition	Min.	Typ.	Max.	Units
<b>Input Supply</b>						
$V_{IN}$	Input Voltage Range ( $V_{IN}$ )		<b>4.5</b>		<b>40</b>	V
$I_S$	Supply Current	DRV = Open		1.3	<b>3</b>	mA
$I_{SD}$	Shutdown Current	$V_{EN} = 0V$			<b>2</b>	$\mu A$
UVLO	$V_{IN}$ UVLO Threshold	$V_{IN}$ Rising	<b>3.2</b>	4	<b>4.5</b>	V
UVLO <sub>HYS</sub>	$V_{IN}$ UVLO Hysteresis			600		mV
<b>VCC Supply</b>						
$V_{CC}$	$V_{CC}$ Output Voltage	$V_{IN} = 12V$ , $I_{CC} = 5mA$	<b>4.5</b>	5	<b>5.5</b>	V
<b>Current Sense</b>						
$\Delta V_{CS}$	Average Current Sense Threshold	$\Delta V_{CS} = V_{INS} - V_{CS}$	190	200	210	mV
			<b>188</b>	200	<b>212</b>	mV
$\Delta t_{CS}$	Current Sense Response Time	$V_{CS}$ Rising		50		ns
		$V_{CS}$ Falling		70		ns
$I_{CS}$	CS Input Current	$V_{IN} = V_{CS}$		0.5	<b>10</b>	$\mu A$
$\Delta V_{HYS}$	Sense Voltage Hysteresis <sup>(5)</sup>	$V_{IN} = 12V$ , $V_{LED} = 3V$ , $L = 47\mu H$ , $F_{SW} = 250kHz$ , $V_D = 0.7V$ , $I_{LED} = 1A$		46		mV
<b>Frequency</b>						
$I_{TIMER}$	CTIMER Pull-up Current			66		$\mu A$
$V_{CTREF}$	CTIMER Threshold			1.189		V
$(4 \cdot I_{TIMER}) / V_{CTREF}$	Frequency Coefficient <sup>(6)</sup>		<b><math>1.776 \times 10^{-4}</math></b>	$2.22 \times 10^{-4}$	<b><math>2.664 \times 10^{-4}</math></b>	A/V

## Electrical Characteristics <sup>(4)</sup> (Continued)

$V_{IN} = V_{EN} = V_{DIM} = 12V$ ;  $C_{VCC} = 4.7\mu F$ ;  $T_J = 25^\circ C$ ; **bold** values indicate  $-40^\circ C \leq T_J \leq +125^\circ C$ , unless noted.

Symbol	Parameter	Condition	Min.	Typ.	Max.	Units
<b>Enable Input</b>						
EN <sub>HI</sub>	EN Logic Level High		<b>2.0</b>			V
EN <sub>LO</sub>	EN Logic Level Low				<b>0.4</b>	V
I <sub>EN</sub>	EN Bias Current	V <sub>EN</sub> = 12V		20	<b>60</b>	μA
		V <sub>EN</sub> = 0V			1	μA
t <sub>START</sub>	Start-Up Time	From EN pin going high to DRV going high		65		μs
<b>Dimming Input</b>						
DIM <sub>HI</sub>	DIM Logic Level High		<b>2.0</b>			V
DIM <sub>LO</sub>	DIM Logic Level Low				<b>0.4</b>	V
I <sub>DIM</sub>	DIM Bias Current	V <sub>DIM</sub> = 12V		20	<b>50</b>	μA
		V <sub>DIM</sub> = 0V			1	μA
t <sub>DIM</sub>	DIM Delay Time	From DIM pin going high to DRV going high		450		ns
f <sub>DIM</sub>	Maximum Dimming Frequency	% of switching frequency		2		%
<b>External FET Driver</b>						
R <sub>ON</sub>	DRV On-Resistance	Pull-Up, I <sub>SOURCE</sub> = 10mA		4		Ω
		Pull-Down, I <sub>SINK</sub> = -10mA		1.5		Ω
t <sub>DRV</sub>	DRV Transition Time	Rise Time, C <sub>LOAD</sub> = 1000pF		13		ns
		Fall Time, C <sub>LOAD</sub> = 1000pF		7		ns
<b>Thermal Protection</b>						
T <sub>LIM</sub>	Overtemperature Shutdown	T <sub>J</sub> Rising		160		°C
T <sub>LIMHYS</sub>	Overtemperature Shutdown Hysteresis			20		°C

### Notes:

- Exceeding the absolute maximum rating can damage the device.
- The device is not guaranteed to function outside its operating rating.
- Devices are ESD sensitive. Handling precautions are recommended. Human body model, 1.5kΩ in series with 100pF.
- Specification for packaged product only.
- See "Sense Voltage Hysteresis Range" in the "Application Information" section.
- See "Frequency of Operation" in the "Application Information" section.

# Typical Characteristics

**Efficiency ( $I_{LED} = 1A$ ) vs. Input Voltage**

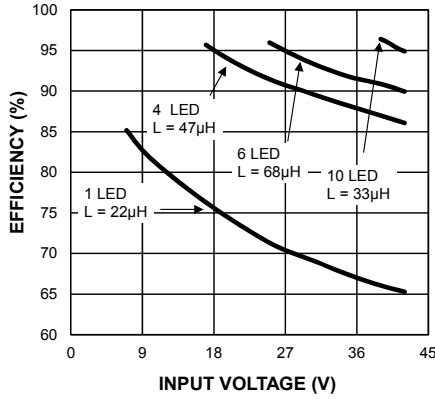

**$V_{IN}$  Supply Current vs. Input Voltage**

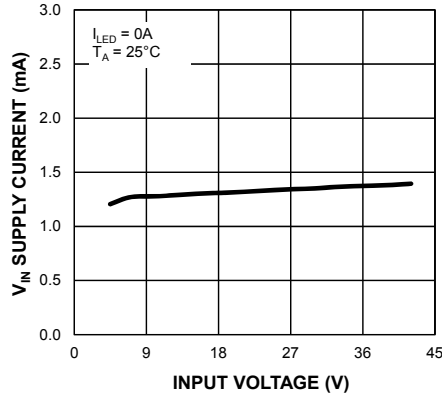

**$V_{IN}$  Shutdown Current vs. Input Voltage**

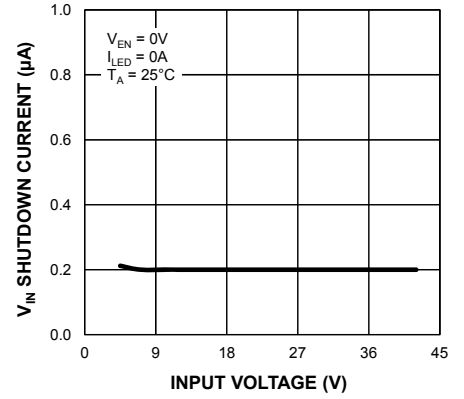

**$V_{CC}$  Output Voltage vs. Input Voltage**

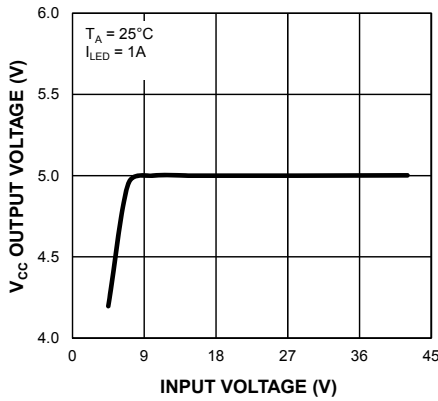

**Normalized Switching Frequency vs. Input Voltage**

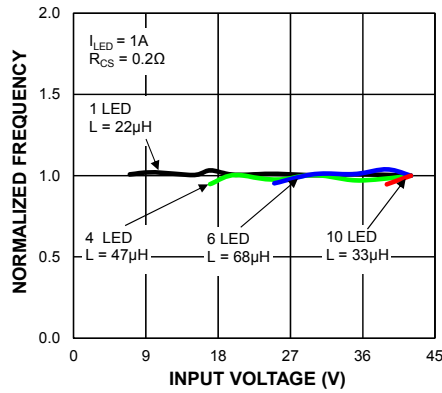

**$I_{LED}$  Output Current vs. Input Voltage**

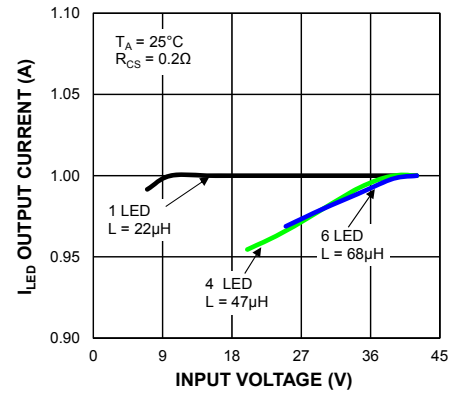

**CTIMER Current vs. Input Voltage**

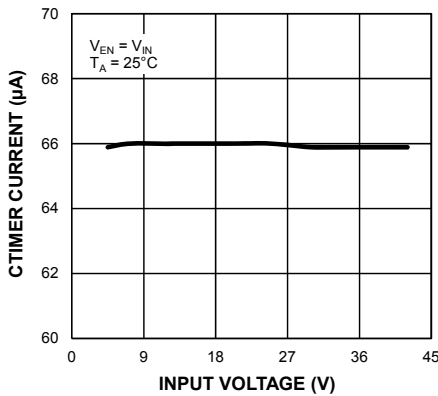

**Enable Threshold vs. Input Voltage**

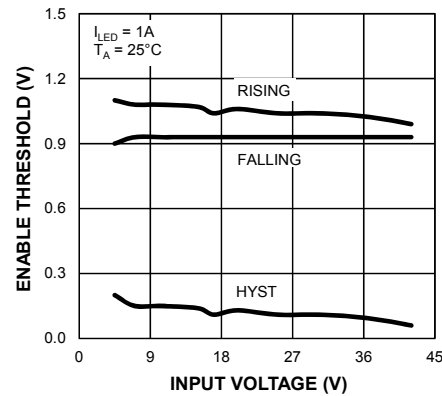

**Enable Bias Current vs. Input Voltage**

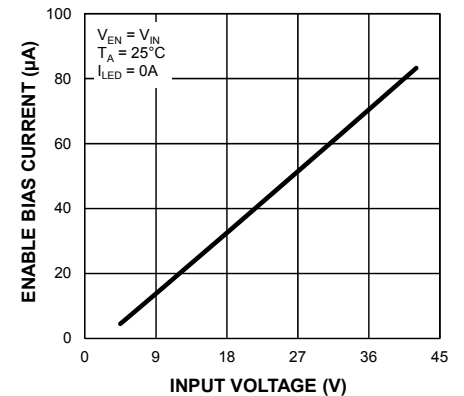

Typical Characteristics (Continued)

Enable Bias Current vs. Enable Voltage

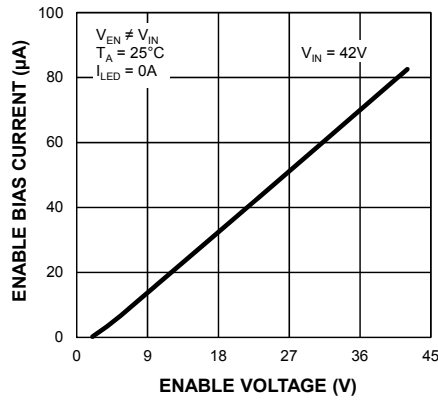

Thermal Shutdown vs. Input Voltage

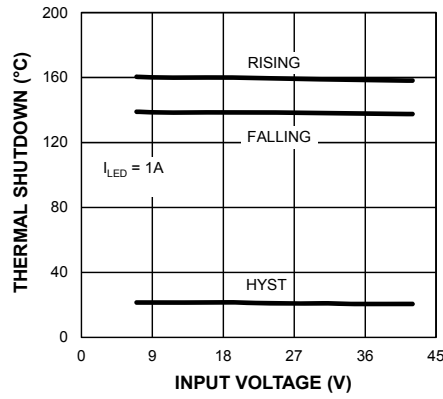

V<sub>IN</sub> Supply Current vs. Temperature

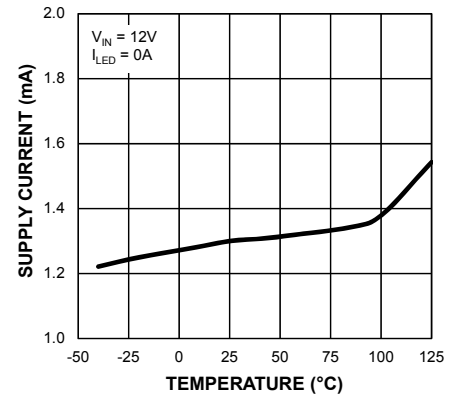

V<sub>IN</sub> Shutdown Current vs. Temperature

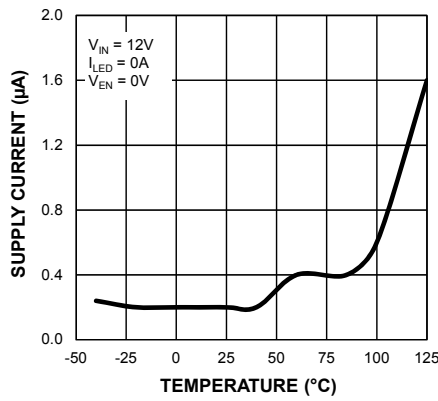

I<sub>LED</sub> Output Current vs. Temperature

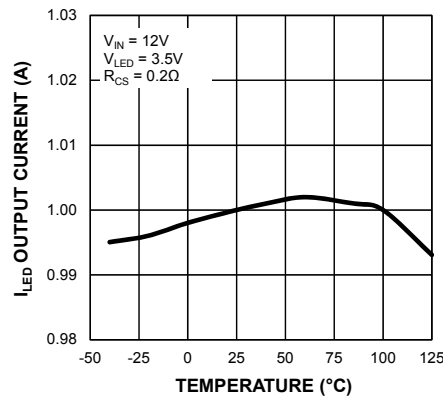

Switching Frequency vs. Temperature

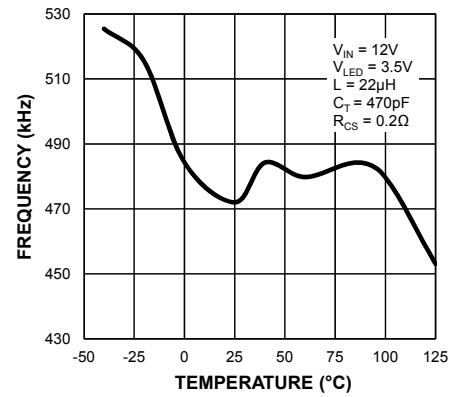

V<sub>CC</sub> vs. Temperature

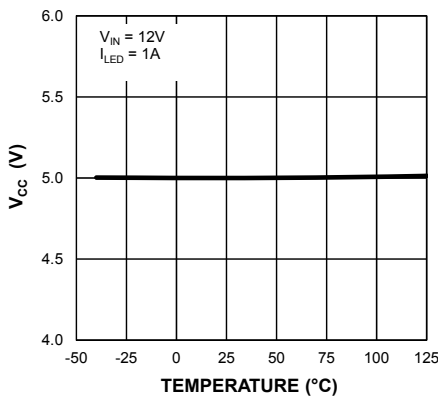

Enable Threshold vs. Temperature

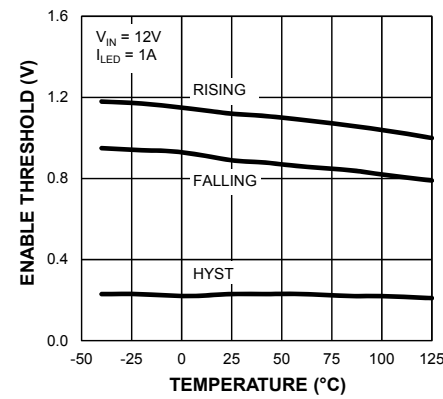

Enable Bias Current vs. Temperature

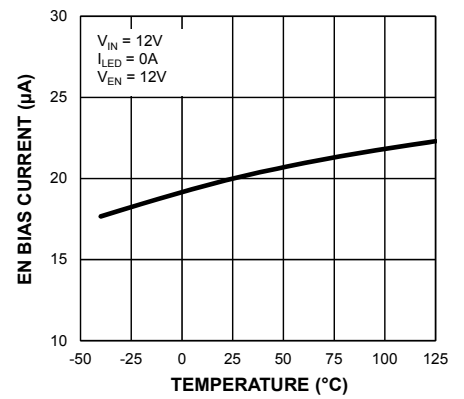

## Typical Characteristics (Continued)

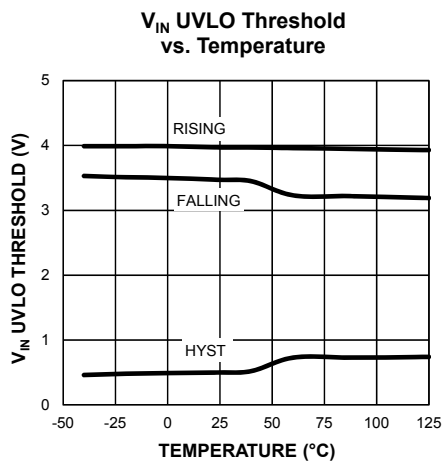

### Functional Characteristics

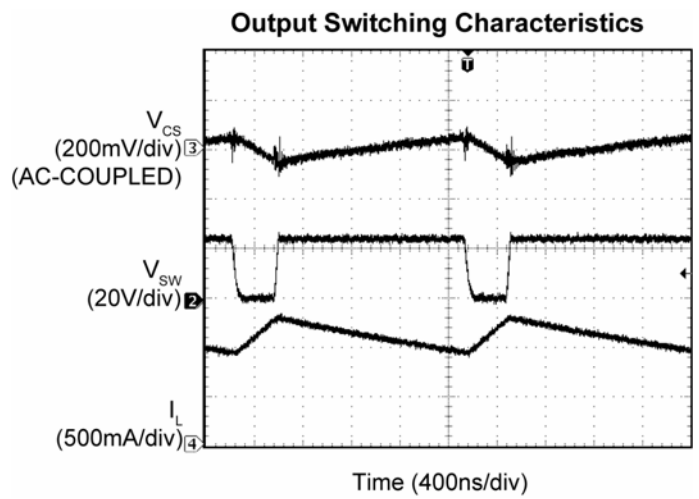
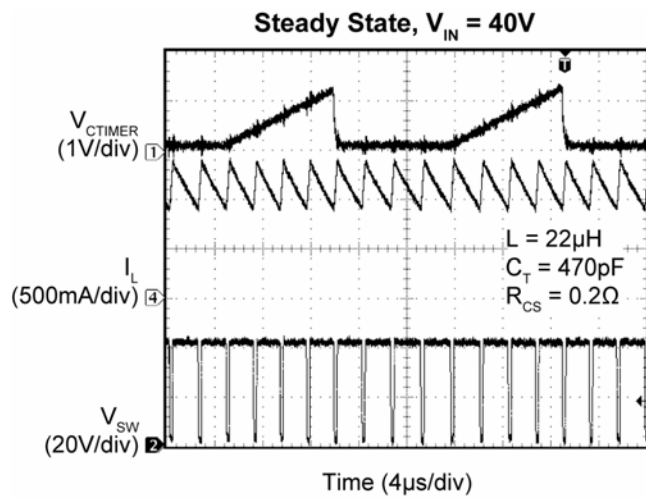
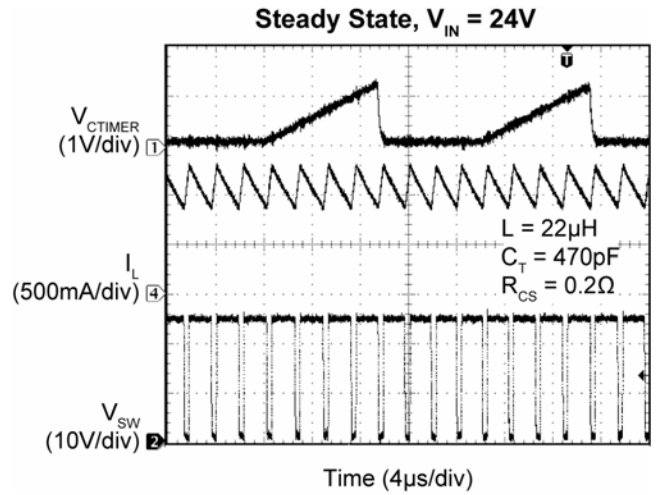
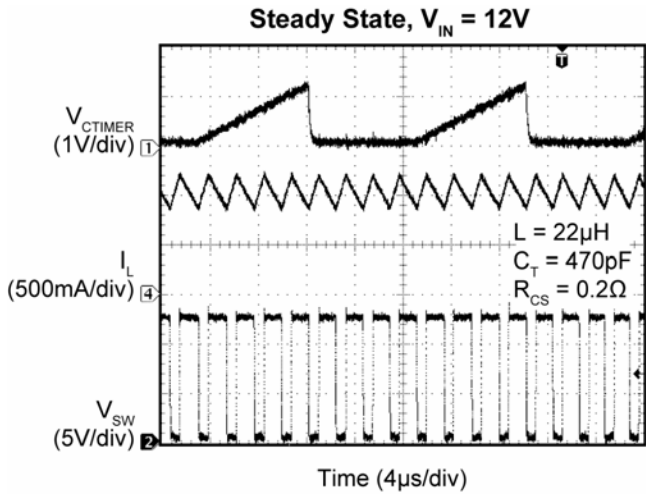



Functional Characteristics (Continued)

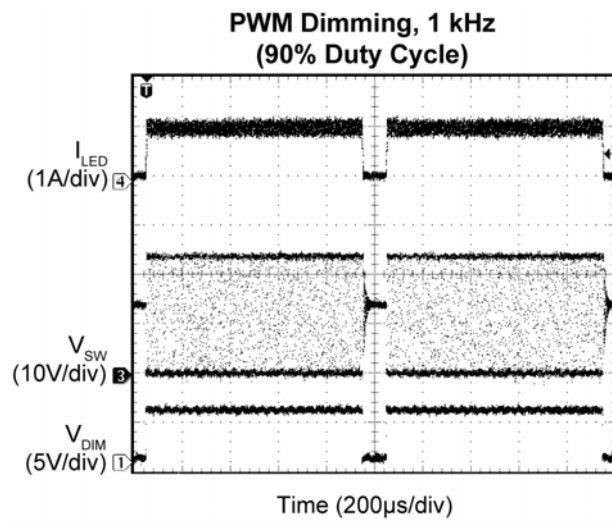
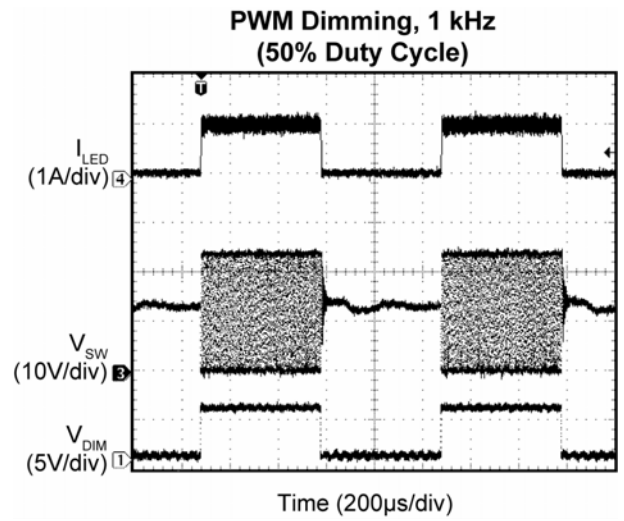
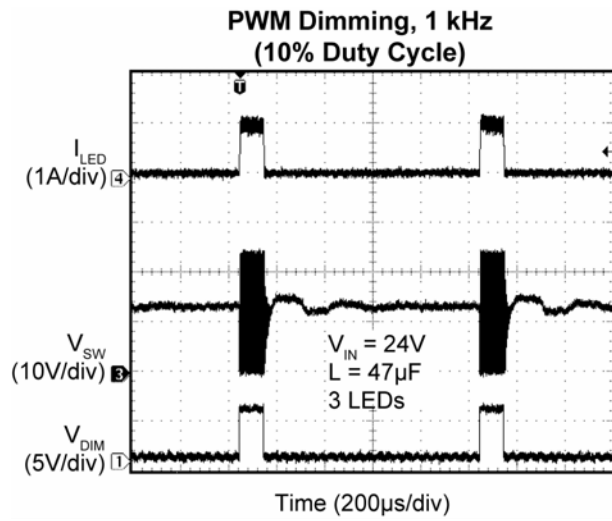

### Functional Diagram

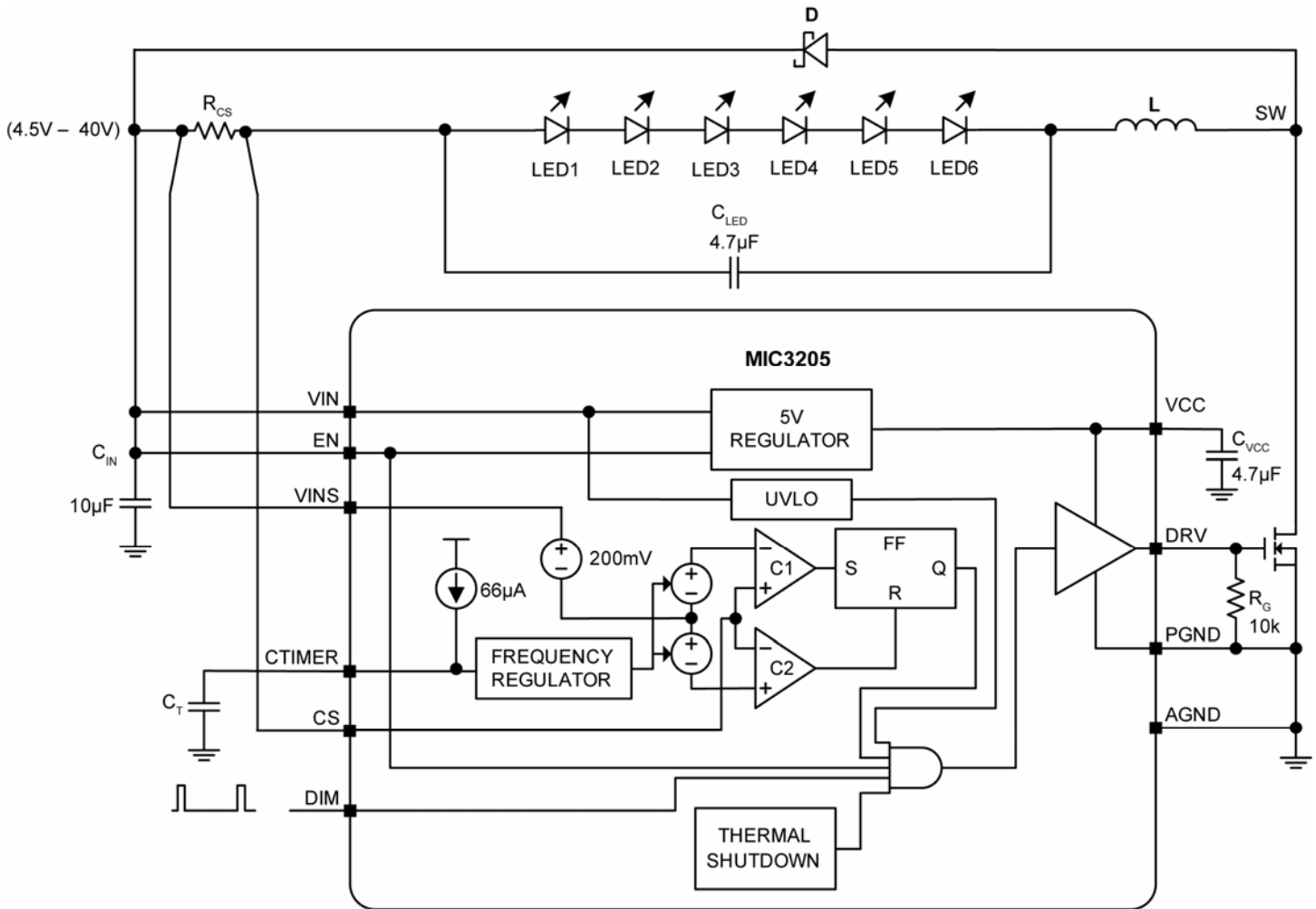

Figure 1. MIC3205 Block Diagram

## Functional Description

The MIC3205 is a hysteretic step-down driver that regulates the LED current with a patent pending frequency regulation scheme. This scheme maintains a fixed operating frequency over a wide input voltage range.

### Theory of Operation

The device operates from a 4.5V to 40V input MOSFET voltage. At turn-on, after the  $V_{IN}$  input voltage crosses 4.5V, the DRV pin is pulled high to turn on an external MOSFET. The inductor and series LED current builds up linearly. This rising current results in a rising differential voltage across the current sense resistor ( $R_{CS}$ ). When this differential voltage reaches an upper threshold, the DRV pin is pulled low, the MOSFET turns off, and the Schottky diode takes over and returns the series LEDs and inductor current to  $V_{IN}$ . Then, the current through the inductor and series LEDs starts to decrease. This decreasing current results in a decreasing differential voltage across  $R_{CS}$ . When this differential voltage reaches a lower threshold, the DRV pin is pulled high, the MOSFET is turned on, and the cycle repeats. The average of the CS pin voltage is 200mV below  $V_{IN}$  voltage. This is the average current sense threshold ( $\Delta V_{CS}$ ). Thus, the CS pin voltage switches about  $V_{IN} - 200\text{mV}$  with a peak-to-peak hysteresis that is the product of the peak-to-peak inductor current times the current sense resistor ( $R_{CS}$ ). The average LED current is set by  $R_{CS}$ , as explained in the “[Application Information](#)” section.

MIC3205 dynamically adjusts hysteresis to accommodate fixed-frequency operation. Average frequency is programmed using an external capacitor connected to the CTIMER pin, as explained in the “[Frequency of Operation](#)” subsection in the “[Application Information](#)” section. The internal frequency regulator dynamically adjusts the inductor current hysteresis every eight switching cycles to make the average switching frequency a constant. If the instantaneous frequency is higher than the programmed average value, the hysteresis is increased to lower the frequency and vice versa. In other hysteretic control systems, current sense hysteresis is constant and frequency can change with input voltage, inductor value, series LEDs voltage drop, or LED current. However, with this patent pending frequency regulation scheme, the MIC3205 changes inductor current hysteresis and keeps the frequency fixed even upon changing input voltage, inductor value, series LEDs voltage drop, or LED current.

The MIC3205 has an on-board 5V regulator, which is for internal use only. Connect a 4.7 $\mu\text{F}$  capacitor on VCC pin to analog ground.

The MIC3205 has an EN pin that gives the flexibility to enable and disable the output with logic high and low signals. The maximum EN voltage is  $V_{IN}$ .

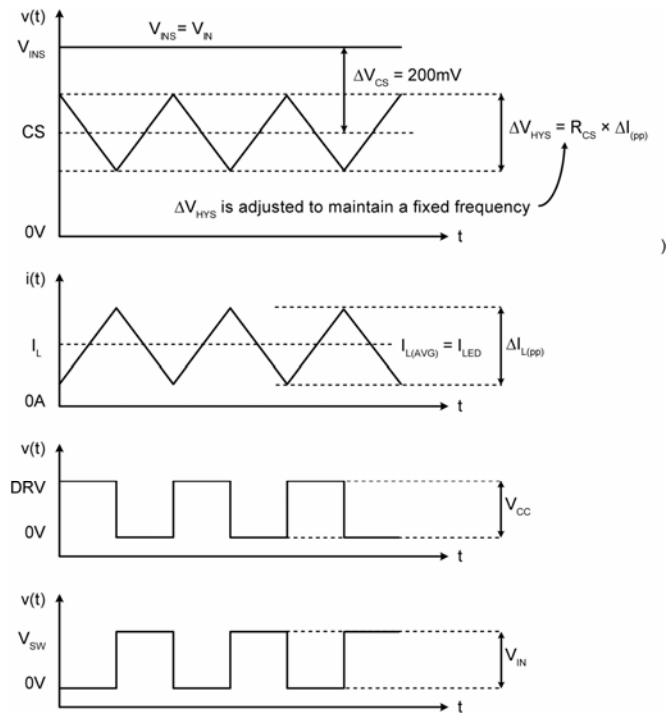

Figure 2. Theory of Operation

### LED Dimming

The MIC3205 LED driver can control the brightness of the LED string through the use of pulse width modulated (PWM) dimming. A DIM pin is provided, which can turn on and off the LEDs if EN is in an active-high state. This DIM pin controls the brightness of the LED by varying the duty cycle of DIM pin from 1% to 99%.

An input signal from DC up to 20kHz can be applied to the DIM pin (see “[Typical Application](#)”) to pulse the LED string on and off. A logic signal can be applied on the DIM pin for dimming, independent of input voltage ( $V_{IN}$ ). Using PWM dimming signals above 120Hz is recommended to avoid any recognizable flicker by the human eye. Maximum allowable dimming frequency is 2% of operating frequency that is set by the external capacitor on the CTIMER pin (see “[Frequency of Operation](#)”). See “[Functional Characteristics](#)” on page 9 for PWM dimming waveforms. Maximum DIM voltage is  $V_{IN}$ .

PWM dimming is the preferred way to dim an LED to prevent color/wavelength shifting. Color/wavelength shifting occurs with analog dimming. By using PWM dimming, the output current level remains constant during each DIM pulse. The hysteretic buck converter switches only when the DIM pin is high. When the DIM pin is low, no LED current flows and the DRV pin is low turning the MOSFET off.

## Application Information

The internal block diagram of the MIC3205 is shown in [Figure 1](#). The MIC3205 is composed of a current-sense comparator, voltage reference, frequency regulator, 5V regulator, and MOSFET driver. Hysteretic mode control, also called bang-bang control, is a topology that does not use an error amplifier, instead using an error comparator.

The frequency regulator dynamically adjusts hysteresis for the current sense comparator to regulate frequency. The inductor current is sensed by an external sense resistor ( $R_{CS}$ ) and controlled within a hysteretic window. It is a simple control scheme with no oscillator and no loop compensation. The control scheme does not need loop compensation. This makes design easy, and avoids instability problems.

Transient response to load and line variation is very fast and depends only on propagation delay. This makes the control scheme very popular for certain applications.

### LED Current and $R_{CS}$

The main feature in MIC3205 is that it controls the LED current accurately within  $\pm 5\%$  of set current. Choosing a high-side  $R_{CS}$  resistor is helpful for setting constant LED current regardless of wide input voltage range. The following equation and [Table 1](#) give the  $R_{CS}$  value for required LED current:

$$R_{CS} = \frac{200\text{mV}}{I_{LED}} \quad \text{Eq. 1}$$

$R_{CS}$ ( $\Omega$ )	$I_{LED}$ (A)	$I^2R$ (W)	Size (SMD)
1.33	0.15	0.03	0603
0.56	0.35	0.07	0805
0.4	0.5	0.1	0805
0.28	0.7	0.137	0805
0.2	1.0	0.2	1206
0.13	1.5	0.3	1206
0.1	2.0	0.4	2010
0.08	2.5	0.5	2010
0.068	3.0	0.6	2010

Table 1.  $R_{CS}$  for LED Current

### Frequency of Operation

The patent pending frequency regulation scheme allows for operating frequency to be programmed by an external capacitor from the CTIMER pin to AGND. The frequency co-efficient (typically  $2.22 \times 10^{-4}$  A/F) divided by the value of this external capacitor connected to the

CTIMER pin, gives the average frequency of operation, as seen in the following equation:

$$F_{SW} = \frac{2.22 \times 10^{-4}}{C_T} \quad \text{Eq. 2}$$

The actual average frequency can vary depending on the variation of the frequency co-efficient and the parasitic board capacitances in parallel to the external capacitor  $C_T$ . As shown in the [Electrical Characteristics](#) table, part to part variation for the frequency co-efficient is  $\pm 20\%$  over temperature, from the target frequency co-efficient of  $2.22 \times 10^{-4}$ .

Switching frequency selection is based on the trade-off between efficiency and system size. Higher frequencies result in smaller, but less efficient, systems and vice versa.

The operating frequency is independent of input voltage, inductor value, series LEDs voltage drop, or LED current, as long as  $40\text{mV} \leq \Delta V_{HYS} \leq 100\text{mV}$  is maintained as explained in the next sections.

### Sense Voltage Hysteresis Range

The frequency regulation scheme requires that the hysteresis remain in a controlled window. Components and operating conditions must be such that the hysteresis on the CS pin is between 40mV and 100mV.

Hysteresis less than 40mV or more than 100mV can result in loss of frequency regulation.

After average LED current ( $I_{LED}$ ) has been set by  $R_{CS}$  and operating frequency has been set by external capacitor  $C_T$ , the hysteresis  $\Delta V_{HYS}$  is calculated as follows:

As seen in [Figure 2](#), for the inductor,

$$\Delta I_L = \frac{\Delta V_{HYS}}{R_{CS}} \quad \text{Eq. 3}$$

where:

$\Delta I_L$  = inductor ripple current

$\Delta V_{HYS}$  = hysteresis on CS pin

For rising inductor current (MOSFET is on):

$$t_r = \frac{L \times \Delta I_L}{V_{L\_RISE}} \quad \text{Eq. 4}$$

where:

$V_{L\_RISE} = V_{IN} - I_{LED} \times R_{CS} - V_{LED}$

$V_{LED}$  is the total voltage drop of the LED string

$V_{IN}$  is the input voltage

$R_{CS}$  is the current sense resistor

$I_{LED}$  is the average LED current

$t_r$  is the MOSFET ON-time  
 $L$  is the inductor

For falling inductor current (MOSFET is off):

$$t_f = \frac{L \times \Delta I_L}{V_{L\_FALL}} \quad \text{Eq. 5}$$

where:

$$V_{L\_FALL} = V_D + I_{LED} \times R_{CS} + V_{LED}$$

$V_D$  is the freewheeling diode forward drop

$t_f$  is the MOSFET OFF-time

Operating frequency and time period are given by:

$$F_{SW} = \frac{1}{T} \quad \text{Eq. 6}$$

$$T = t_r + t_f \quad \text{Eq. 7}$$

Using Equations 3, 4, 5, 6, and 7:

$$\Delta V_{HYS} = \frac{(V_{IN} - I_{LED} \times R_{CS} - V_{LED}) \times (V_D + I_{LED} \times R_{CS} + V_{LED}) \times R_{CS}}{(V_{IN} + V_D) \times L \times F_{SW}} \quad \text{Eq. 8}$$

The value of  $\Delta V_{HYS}$  calculated in this way must be between 40mV and 100mV to ensure frequency regulation.

**Inductor**

According to the above equations, the inductor value can be calculated once average LED current, operating frequency and an appropriate hysteresis  $\Delta V_{HYS}$  value have been chosen.

Thus, inductor  $L$  is given by:

$$L = \frac{(V_{IN} - I_{LED} \times R_{CS} - V_{LED}) \times (V_D + I_{LED} \times R_{CS} + V_{LED}) \times R_{CS}}{(V_{IN} + V_D) \times \Delta V_{HYS} \times F_{SW}} \quad \text{Eq. 9}$$

Table 2, Table 3, and Table 4 give reference inductor values for an operating frequency of 400 kHz, for a given LED current, freewheeling diode forward drop, and number of LEDs. By selecting  $\Delta V_{HYS}$  in the 55mV to 75mV range, we get the following inductor values:

R <sub>CS</sub> (Ω)	I <sub>LED</sub> (A)	V <sub>IN</sub> (V)	L (μH)	ΔV <sub>HYS</sub> (mV)
0.56	0.35	5	22	64.1
0.56	0.35	12	68	57.7
0.28	0.7	5	10	70.5
0.28	0.7	12	33	59.4
0.2	1.0	5	6.8	72.6
0.2	1.0	12	22	62.4
0.1	2.0	5	3.6	68.5
0.1	2.0	12	10	68.6

**Table 2. Inductor for F<sub>SW</sub> = 400 kHz, V<sub>D</sub> = 0.4V, 1 LED**

R <sub>CS</sub> (Ω)	I <sub>LED</sub> (A)	V <sub>IN</sub> (V)	L (μH)	ΔV <sub>HYS</sub> (mV)
0.56	0.35	24	150	55.8
0.56	0.35	36	220	56.8
0.28	0.7	24	68	61.6
0.28	0.7	36	100	62.5
0.2	1.0	24	47	62.4
0.2	1.0	36	68	64.3
0.1	2.0	24	22	66.6
0.1	2.0	36	33	66.2

**Table 3. Inductor for F<sub>SW</sub> = 400 kHz, V<sub>D</sub> = 0.4V, 4 LED**

R <sub>CS</sub> (Ω)	I <sub>LED</sub> (A)	V <sub>IN</sub> (V)	L (μH)	ΔV <sub>HYS</sub> (mV)
0.56	0.35	36	150	58.4
0.56	0.35	40	220	54.3
0.28	0.7	36	68	64.4
0.28	0.7	40	100	59.6
0.2	1.0	36	47	65.2
0.2	1.0	40	68	61.4
0.1	2.0	36	22	69.6
0.1	2.0	40	33	63.3

**Table 4. Inductor for F<sub>SW</sub> = 400 kHz, V<sub>D</sub> = 0.4V, 8 LED**

Given an inductor value, the size of the inductor can be determined by its RMS and peak current rating. Because LEDs are in series with the inductor,

$$I_L = I_{LED} \quad \text{Eq. 10}$$

From Equations 1, 3, and 10:

$$\frac{\Delta I_L}{I_L} = \frac{\Delta V_{HYS}}{200m} \quad \text{Eq. 11}$$

With  $40\text{mV} \leq \Delta V_{\text{HYS}} \leq 100\text{mV}$ :

$$I_{\text{L(RMS)}} = \sqrt{I_{\text{L}}^2 + \frac{1}{12} \Delta I_{\text{L}}^2} \approx I_{\text{L}} \quad \text{Eq. 12}$$

$$I_{\text{L(PK)}} = I_{\text{L}} \left(1 + \frac{\Delta V_{\text{HYS}}}{400\text{m}}\right) \quad \text{Eq. 13}$$

where:

$I_{\text{L}}$  is the average inductor current

$I_{\text{L(PK)}}$  is the peak inductor current

Select an inductor with a saturation current rating at least 30% higher than the peak current.

For space-sensitive applications, smaller inductors with higher switching frequency could be used but regulator efficiency will be reduced.

### MOSFET

N-channel MOSFET selection depends on the maximum input voltage, output LED current, and switching frequency.

The selected N-channel MOSFET should have 30% margin on maximum voltage rating for high reliability requirements.

The MOSFET channel resistance ( $R_{\text{DS(ON)}}$ ) is selected such that it helps to get the required efficiency at the required LED currents and meets the cost requirement.

Logic level MOSFETs are preferred as the drive voltage is limited to 5V.

The MOSFET power loss has to be calculated for proper operation. The power loss consists of conduction loss and switching loss. The conduction loss can be found by:

$$P_{\text{LOSS(CON)}} = I_{\text{RMS(FET)}}^2 \times R_{\text{DS(ON)}}$$

$$I_{\text{RMS(FET)}} = I_{\text{LED}} \times \sqrt{D}$$

$$D \approx \frac{V_{\text{LED}}}{V_{\text{IN}}}$$

The switching loss occurs during the MOSFET turn-on and turn-off transition and can be found by:

$$P_{\text{LOSS(TRAN)}} = \frac{V_{\text{IN}} \times I_{\text{LED}} \times F_{\text{SW}}}{I_{\text{DRV}}} \times (Q_{\text{gs2}} + Q_{\text{gd}})$$

$$I_{\text{DRV}} = \frac{V_{\text{DRV}}}{R_{\text{GATE}}}$$

where:

$R_{\text{GATE}}$  is total MOSFET gate resistance;  $Q_{\text{gs2}}$  and  $Q_{\text{gd}}$  can be found in a MOSFET manufacturer data sheet.

A gate resistor can be connected between the MOSFET gate and the DRV pin to slow down MOSFET switching edges. A 2Ω resistor is usually sufficient.

The total power loss is:

$$P_{\text{LOSS(TOT)}} = P_{\text{LOSS(CON)}} + P_{\text{LOSS(TRAN)}}$$

The MOSFET junction temperature is given by:

$$T_{\text{J}} = P_{\text{LOSS(TOT)}} \times R_{\theta\text{JA}} + T_{\text{A}}$$

$T_{\text{J}}$  must not exceed maximum junction temperature under any conditions.

### Freewheeling Diode

The freewheeling diode should have a reverse voltage rating that is at least 20% higher than the maximum input supply voltage. The forward voltage drop should be small to get the lowest conduction dissipation for high efficiency. The forward current rating should be at least equal to the LED current. Schottky diodes with low forward voltage drop and fast reverse recovery are ideal choices and give the highest efficiency. The freewheeling diode average current ( $I_{\text{D}}$ ) is given by:

$$I_{\text{D}} = (1 - D) \times I_{\text{LED}}$$

Diode power dissipation ( $P_{\text{D}}$ ) is given by:

$$P_{\text{D}} = V_{\text{D}} \times I_{\text{D}}$$

Typically, higher current rating diodes have a lower  $V_{\text{D}}$  and have better thermal performance, improving efficiency.

### Input Capacitor

The ceramic input capacitor is selected by voltage rating and ripple current rating. A 10μF ceramic capacitor is usually sufficient. Select a voltage rating that is at least 30% larger than the maximum input voltage.

### LED Ripple Current

The LED current is the same as inductor current  $\Delta I_{\text{L}}$ . A ceramic capacitor should be placed across the series LEDs to pass the ripple current. A 4.7μF capacitor is usually sufficient for most applications. Voltage rating should be the same as the input capacitor.

## PCB Layout Guidelines

**NOTE:** To minimize EMI and output noise, follow these layout recommendations.

PCB layout is critical to achieve reliable, stable, and efficient performance. A ground plane is required to control EMI and minimize the inductance in power, signal, and return paths.

Follow these guidelines to ensure proper operation of the MIC3205.

### IC

- Use thick traces to route the input and output power lines.
- Keep signal and power grounds separate and connect them at only one location.

### Input Capacitor

- Place the input capacitors on the same side of the board and as close to the IC as possible.
- Keep both the VIN and PGND traces as short as possible.
- If the application requires vias to the ground plane, place them close to the input capacitor ground terminal, but not between the input capacitors and IC pins.
- Use either X7R or X5R dielectric input capacitors. Do not use Y5V or Z5U type capacitors.
- Do not replace the ceramic input capacitor with any other type of capacitor. Any type of capacitor can be placed in parallel with the ceramic input capacitor.
- If a tantalum input capacitor is placed in parallel with the ceramic input capacitor, it must be recommended for switching regulator applications and the operating voltage must be derated by 50%.
- In “Hot-Plug” applications, place a tantalum or electrolytic bypass capacitor in parallel to the ceramic capacitor to limit the overvoltage spike seen on the input supply when power is suddenly applied. In this case, an additional tantalum or electrolytic bypass input capacitor of 22 $\mu$ F or higher is required at the input power connection.

### Inductor

- Keep the inductor connection to the switch node (MOSFET drain) short.
- Do not route any digital lines underneath or close to the inductor.
- To minimize noise, place a ground plane underneath the inductor.

### LED Ripple Current Carrying Capacitor

- Place this ceramic capacitor as close to the LEDs as possible.
- Use either X7R or X5R dielectric capacitors. Do not use Y5V or Z5U type capacitors.

### MOSFET

- To avoid trace inductance, place the N-channel MOSFET as close as possible to the MIC3205.
- Provide sufficient copper area on MOSFET ground to dissipate the heat.

### Freewheeling Diode

- Place the Schottky diode on the same side of the board as the IC and input capacitor.
- Keep the connection from the Schottky diode’s anode to the switching node as short as possible.
- Keep the diode’s cathode connection to the R<sub>CS</sub> as short as possible.

### RC Snubber

- If an RC snubber is needed, place the RC snubber on the same side of the board and as close to the Schottky diode as possible. A 1.2 $\Omega$  resistor in series with a 1nF capacitor is usually a good choice.

### R<sub>CS</sub> (Current-Sense Resistor)

- VINS pin and CS pin must be as close as possible to R<sub>CS</sub>.
- Make a Kelvin connection to the VINS and CS pin, respectively, for current sensing. For low values of  $\Delta V_{HYS}$  (around 40mV) the switching noise could cause faulty switching on the DRV pin. If this occurs, place two 30 $\Omega$  resistors and a 1nF capacitor, as shown in [Figure 3](#), to filter out switching noise for low values of  $\Delta V_{HYS}$ . Alternatively, as seen in Equation 8, a smaller inductor value can be used to increase  $\Delta V_{HYS}$  and make the system more noise tolerant.

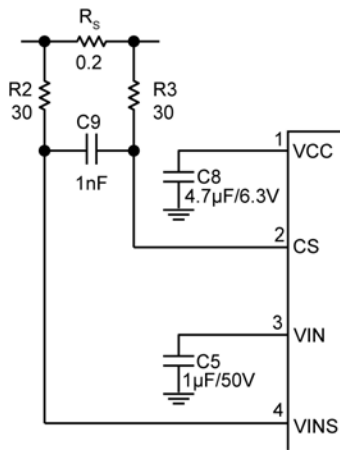

Figure 3. Input Filter for Low Values of  $\Delta V_{HYS}$

**Trace Routing Recommendation**

Keep the power traces as short and wide as possible. There is one current flowing loop during the MOSFET ON-time; the traces connect the input capacitor ( $C_{IN}$ ),  $R_{CS}$ , the LEDs, the inductor, the MOSFET, and back to  $C_{IN}$ . There is another current flowing loop during the MOSFET OFF-time; the traces for this loop connect  $R_{CS}$ , the LED, the inductor, the freewheeling diode, and back to  $R_{CS}$ . These two loop areas should be kept as small as possible to minimize noise interference

Keep all analog signal traces away from the switching node and its connecting traces.

**Design Example**

**SPECIFICATIONS:**

- $F_{SW} = 400 \text{ kHz}$
- $V_{SUPPLY} = 24V \text{ rectified AC}$
- $I_{LED} = 1A$
- Voltage drop per LED = 3.5V
- Number of LEDs = 4
- Schottky diode drop at 1A = 0.4V

**1. CURRENT SENSE RESISTOR**

From Equation 1:  $R_{CS} = \frac{200mV}{I_{LED}}$

For  $I_{LED} = 1A$   
 $R_{CS} = 0.2\Omega$

**2. SWITCHING FREQUENCY**

From Equation 2:  $F_{SW} = \frac{2.22 \times 10^{-4}}{C_T}$

For  $F_{SW} = 400 \text{ kHz}$

$C_T = 550pF$

The actual frequency may vary as explained in “Frequency of Operation” in the “Application Information” section.

**3. INDUCTOR SELECTION**

From Equation 9:

$$L = \frac{(V_{IN} - I_{LED} \times R_{CS} - V_{LED}) \times (V_D + I_{LED} \times R_{CS} + V_{LED}) \times R_{CS}}{(V_{IN} + V_D) \times \Delta V_{HYS} \times F_{SW}}$$

Given  $V_{SUPPLY} = 24V \text{ rectified AC}$

The peak voltage =  $\sqrt{2} \times V_{SUPPLY}$

Thus for MIC3205,  $V_{IN} \approx 34V$

$V_{LED} = 3.5 \times 4 = 14, V_D = 0.4V$

Select  $\Delta V_{HYS} = 60mV$

Thus,  $L = 70\mu H$

Chose  $L = 68\mu H$  as closest available value.

As a side note, for this example,  $L = 68\mu H$  can be used even if  $V_{SUPPLY} = 24V \text{ DC}$ . This is because  $\Delta V_{HYS}$  calculates to around 44mV (with  $V_{IN} = V_{SUPPLY} = 24V$ ) which is acceptable.

From Equations 12 and 13:

$I_{L(PK)} = 1.15A$

Thus, we choose  $L = 68\mu H$  with an RMS saturation current of 1.5A or higher.

**4. MOSFET SELECTION**

For this example,  $V_{IN} = 34V$ , a 50V rating or greater N-channel MOSFET is required. A high current rating MOSFET is a good choice because it has lower  $R_{DS(ON)}$ .

A 60V, 12A MOSFET with 10m $\Omega$   $R_{DS(ON)}$  is a good choice.

**5. CAPACITOR SELECTION**

Use a 10 $\mu F$ /50V X7R type ceramic capacitor for the input capacitor.

Use a 4.7 $\mu F$ /50V X5R type ceramic capacitor for the LED ripple current carrying capacitor connected across the series connection of 4 LEDs

**6. FREEWHEELING DIODE SELECTION**

With  $V_{IN} = 34V$ , choose a 2A, 60V Schottky diode with a forward drop voltage of 0.4V at 1A forward current.





## Bill of Materials

Item	Part Number	Manufacturer	Description	Qty.
C1, C2,C3,C4,C11	12105C475KAZ2A	AVX <sup>(1)</sup>	4.7μF/50V, Ceramic Capacitor, X7R, Size 1210	5
	GRM32ER71H475KA88L	Murata <sup>(2)</sup>		
	CGA6P3X7R1H475K	TDK <sup>(3)</sup>		
C5	GRM21BR71H105KA12L	Murata	1μF/50V, Ceramic Capacitor, X7R, Size 0805	1
	CGA4J3X7R1H105K	TDK		
C10	06035C471K4T2A	AVX	470pF/50V, Ceramic Capacitor, X7R, Size 0603	1
	GRM188R71H471KA01D	Murata		
	C1608X7R1H471K	TDK		
C8	06036D475KAT2A	AVX	4.7μF/6.3V, Ceramic Capacitor, X5R, Size 0603	1
	GRM188R60J475KE19J	Murata		
	CGA3E1X5R0J475K	TDK		
C7,C9	06035C102KAT2A	AVX	1nF/50V, Ceramic Capacitor, X7R, Size 0603	2
	GRM188R71H102KA01D	Murata		
	C1608X7R1H102K	TDK		
D1	SK36-TP	MCC <sup>(4)</sup>	60V, 3A, SMC, Schottky Diode	1
	SK36	Fairchild <sup>(5)</sup>		
	SK36-7-F	Diodes, Inc. <sup>(6)</sup>		
L1	SLF10145T-220M1R9-PF	TDK	22μH, 2.1A, 0.0591Ω, SMT, Power Inductor	1
M1	FDS5672	Fairchild	MOSFET, N-CH, 60V, 12A, SO-8	1
Rcs	CSR1206FKR200	Stackpole Electronics, Inc. <sup>(7)</sup>	0.2Ω Resistor, 1/2W, 1%, Size 1206	1
R5, R8	CRCW0603100KFKEA	Vishay Dale <sup>(8)</sup>	100kΩ Resistor, 1%, Size 0603	2
R2, R3	CRCW060330R0FKEA	Vishay Dale	30Ω Resistor, 1%, Size 0603	2
R1, R9	CRCW06032R00FKEA	Vishay Dale	2Ω Resistor, 1%, Size 0603	2
R4	CRCW060310K0FKEA	Vishay Dale	10kΩ Resistor, 1%, Size 0603	1
R6	CRCW060351R0FKEA	Vishay Dale	51Ω Resistor, 1%, Size 0603	1
R7	CRCW06030000Z0EA	Vishay Dale	0Ω Resistor, Size 0603	1
U1	MIC3205YML	Micrel, Inc. <sup>(9)</sup>	High-Brightness LED Driver Controller with Fixed Frequency Hysteretic Control	1

### Notes:

1. AVX: [www.avx.com](http://www.avx.com).
2. Murata: [www.murata.com](http://www.murata.com).
3. TDK: [www.tdk.com](http://www.tdk.com).
4. MCC: [www.mccsemi.com](http://www.mccsemi.com).
5. Fairchild: [www.fairchildsemi.com](http://www.fairchildsemi.com).
6. Diodes Inc.: [www.diodes.com](http://www.diodes.com).
7. Stackpole Electronics: [www.seielect.com](http://www.seielect.com).
8. Vishay Dale: [www.vishay.com](http://www.vishay.com).
9. Micrel, Inc.: [www.micrel.com](http://www.micrel.com).



### PCB Layout Recommendations (Continued)

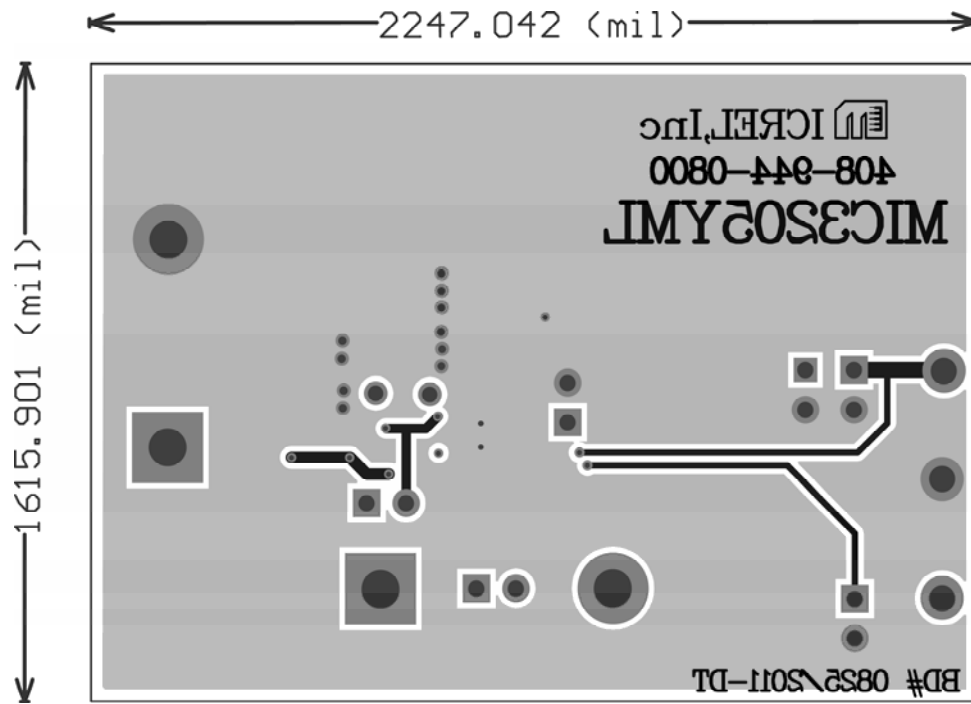

Bottom Layer

### Package Information

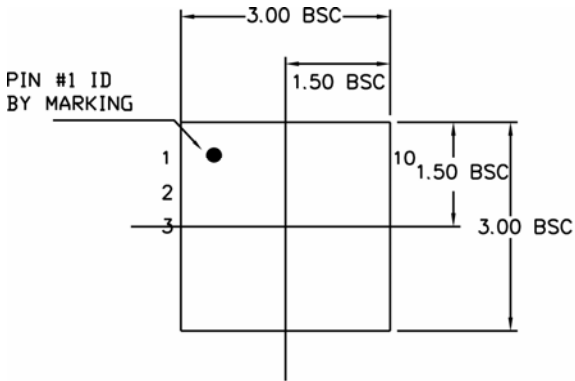

TOP VIEW

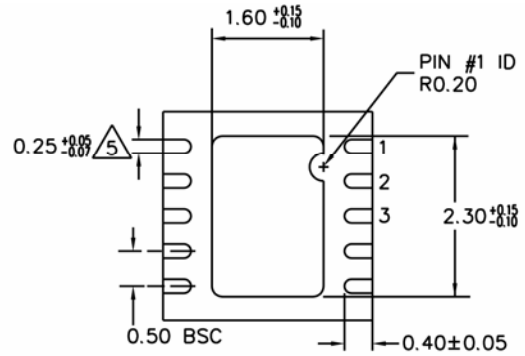

BOTTOM VIEW

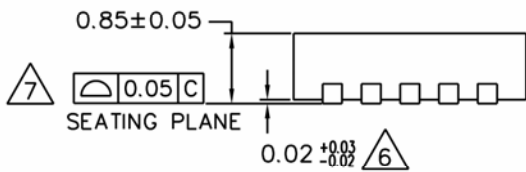

SIDE VIEW

NOTE:

1. ALL DIMENSIONS ARE IN MILLIMETERS.
2. MAX. PACKAGE WARPAGE IS 0.05 mm.
3. MAXIMUM ALLOWABLE BURRS IS 0.076 mm IN ALL DIRECTIONS.
4. PIN #1 ID ON TOP WILL BE LASER/INK MARKED.
5. DIMENSION APPLIES TO METALIZED TERMINAL AND IS MEASURED BETWEEN 0.20 AND 0.25 mm FROM TERMINAL TIP.
6. APPLIED ONLY FOR TERMINALS.
7. APPLIED FOR EXPOSED PAD AND TERMINALS.

10-Pin 3mm x 3mm MLF (ML)

## Recommended Landing Pattern

LP # **MLF33D-10LD-LP-1**  
 All units are in mm  
 Tolerance  $\pm 0.05$  if not noted

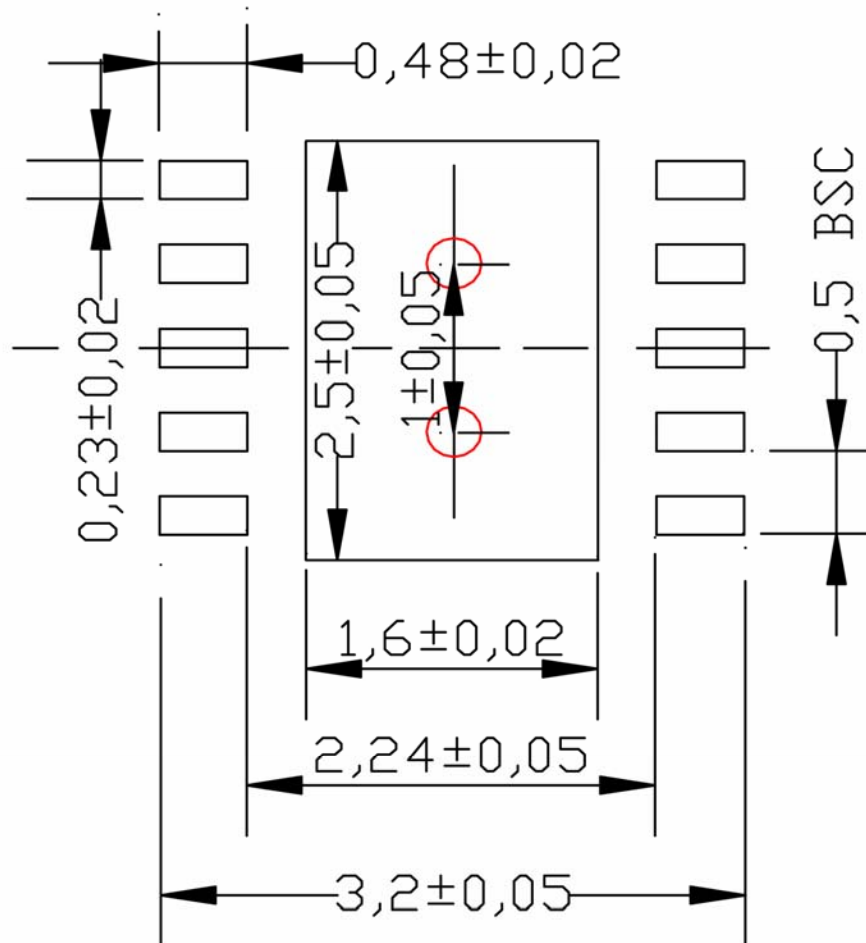

Red circle indicates Thermal Via. Size should be 0.300-0.350mm in diameter and it should be connected to GND plane for maximum thermal performance.

**10-Pin 3mm x 3mm MLF (ML) Land Pattern**

---

**MICREL, INC. 2180 FORTUNE DRIVE SAN JOSE, CA 95131 USA**  
TEL +1 (408) 944-0800 FAX +1 (408) 474-1000 WEB <http://www.micrel.com>

Micrel makes no representations or warranties with respect to the accuracy or completeness of the information furnished in this data sheet. This information is not intended as a warranty and Micrel does not assume responsibility for its use. Micrel reserves the right to change circuitry, specifications and descriptions at any time without notice. No license, whether express, implied, arising by estoppel or otherwise, to any intellectual property rights is granted by this document. Except as provided in Micrel's terms and conditions of sale for such products, Micrel assumes no liability whatsoever, and Micrel disclaims any express or implied warranty relating to the sale and/or use of Micrel products including liability or warranties relating to fitness for a particular purpose, merchantability, or infringement of any patent, copyright or other intellectual property right.

Micrel Products are not designed or authorized for use as components in life support appliances, devices or systems where malfunction of a product can reasonably be expected to result in personal injury. Life support devices or systems are devices or systems that (a) are intended for surgical implant into the body or (b) support or sustain life, and whose failure to perform can be reasonably expected to result in a significant injury to the user. A Purchaser's use or sale of Micrel Products for use in life support appliances, devices or systems is a Purchaser's own risk and Purchaser agrees to fully indemnify Micrel for any damages resulting from such use or sale.

© 2012 Micrel, Incorporated.

## X-ON Electronics

Largest Supplier of Electrical and Electronic Components

*Click to view similar products for [LED Lighting Drivers](#) category:*

*Click to view products by [Micrel](#) manufacturer:*

Other Similar products are found below :

[LV5235V-MPB-H](#) [MB39C602PNF-G-JNEFE1](#) [MIC2871YMK-T5](#) [AL1676-10BS7-13](#) [AL1676-20AS7-13](#) [AP5726WUG-7](#) [MX877RTR](#)  
[ICL8201](#) [IS31BL3228B-UTLS2-TR](#) [IS31BL3506B-TTLS2-TR](#) [AL3157F-7](#) [AP5725FDCG-7](#) [AP5726FDCG-7](#) [LV52204MTTBG](#)  
[AP5725WUG-7](#) [STP4CMPQTR](#) [NCL30086BDR2G](#) [CAT4004BHU2-GT3](#) [LV52207AXA-VH](#) [AP1694AS-13](#) [TLE4242EJ](#) [AS3688](#)  
[IS31LT3172-GRLS4-TR](#) [TLD2311EL](#) [KTD2694EDQ-TR](#) [KTZ8864EJAA-TR](#) [IS32LT3174-GRLA3-TR](#) [ZXLD1374QESTTC](#) [MP2488DN-](#)  
[LF-Z](#) [NLM0010XTSA1](#) [AL1676-20BS7-13](#) [MPQ7220GF-AEC1-P](#) [MPQ4425BGJ-AEC1-P](#) [MPQ7220GF-AEC1-Z](#) [MPQ4425BGJ-AEC1-Z](#)  
[IS31FL3737B-QFLS4-TR](#) [IS31FL3239-QFLS4-TR](#) [KTD2058EUAC-TR](#) [KTD2037EWE-TR](#) [DIO5662ST6](#) [IS31BL3508A-TTLS2-TR](#)  
[MAX20052CATC/V+](#) [MAX25606AUP/V+](#) [BD6586MUV-E2](#) [BD9206EFV-E2](#) [BD9416FS-E2](#) [LYT4227E](#) [LYT6079C-TL](#) [MP3394SGF-P](#)  
[MP4689AGN-P](#)