



## MIC5234

### Low-Quiescent Current 150mA LDO Regulator

#### General Description

The MIC5234 is a low-quiescent current,  $\mu$ Cap low-dropout regulator. With a maximum operating input voltage of 30V and quiescent current of 20 $\mu$ A, it is ideal for supplying keep-alive power in systems with high-voltage batteries.

Capable of 150mA output, the MIC5234 has a dropout voltage of only 320mV. It can also survive an input transient of -20V to +32V. The MIC5234 requires only a 2.2 $\mu$ F output capacitor for stable operation.

The MIC5234 includes a logic compatible enable input. Other features of the MIC5234 include thermal shutdown, current limit, overvoltage shutdown, load dump protection, reverse-leakage and reverse battery protection.

The MIC5234 is available in an 8-pin ePad SOIC package with a junction operating range from -40°C to +125°C.

Data sheets and support documentation can be found on Micrel's web site at: [www.micrel.com](http://www.micrel.com).

#### Features

- Ultra-low quiescent current ( $I_Q = 20\mu\text{A} @ I_O = 100\mu\text{A}$ )
- Wide input voltage range: 2.3V to 30V
- Low dropout:
  - 230mV @50mA
  - 320mV @150mA
- Adjustable output voltage
- Typical  $\pm 1.0\%$  initial output accuracy
- Logic compatible enable input
- Overcurrent protection
- Thermal-shutdown protection
- Reverse-leakage and reverse-battery protection
- Thermally enhanced 8-pin ePad SOIC package

#### Applications

- "Keep-alive" supply in notebook and portable personal computers
- Logic supply from high-voltage batteries
- Automotive electronics
- Battery-powered systems

#### Typical Application

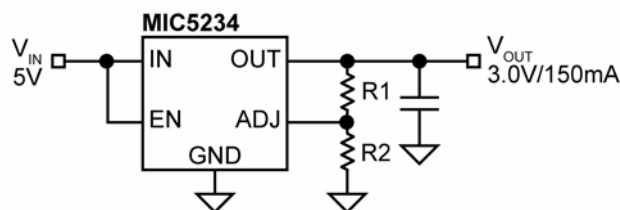

Regulator with Adjustable Output

## Ordering Information

Part Number	Voltage	Junction Temperature Range	Package <sup>(1)</sup>	Lead Finish
MIC5234YME	Adjustable	-40°C to +125°C	8-Pin ePad SOIC	NiPdAu

**Note:**

1. ePad SOIC is a Green RoHS-compliant package. Mold compound is halogen free.

## Pin Configuration

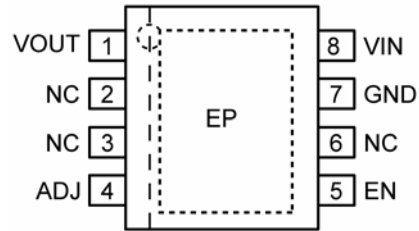

**8-Pin ePad SOIC**

## Pin Description

Pin Number	Pin Name	Pin Function
1	VOUT	Regulated Output.
2, 3, 6	NC	No Connect.
4	ADJ	Adjustable Feedback Input. Connect to voltage divider network.
5	EN	Enable (Input). Logic low = shutdown; logic high = enabled. Do not leave floating.
7	GND	Ground.
8	VIN	Power Supply Input.
EP	ePad	Exposed Thermal Pad. Connect to the ground plane to maximize thermal performance.

**Absolute Maximum Ratings<sup>(1)</sup>**

Supply Voltage ( $V_{IN}$ )	-20V to +32V
Power Dissipation <sup>(3)</sup>	Internally Limited
Junction Temperature ( $T_J$ )	+150°C
Storage Temperature ( $T_S$ )	-65°C to +150°C
Lead Temperature (soldering, 10s)	260°C
ESD Rating <sup>(4)</sup>	ESD Sensitive

**Operating Ratings<sup>(2)</sup>**

Supply Voltage ( $V_{IN}$ )	+2.3V to +30V
Enable Voltage ( $V_{EN}$ )	0V to +30V
Junction Temperature ( $T_J$ )	-40°C to +125°C
Package Thermal Resistance	
ePad SOIC ( $\theta_{JA}$ )	41°C/W

**Electrical Characteristics<sup>(5)</sup>**

$V_{IN} = V_{OUT} + 1V$ ;  $V_{EN} = 2.0V$ ;  $C_{OUT} = 4.7\mu F$ ;  $I_{OUT} = 100\mu A$ ;  $T_J = 25^\circ C$ , **bold** values indicate  $-40^\circ C \leq T_J \leq +125^\circ C$ , unless noted.

Symbol	Parameter	Condition	Min.	Typ.	Max.	Units
$V_{ADJ}$	Feedback Voltage		<b>1.2054</b>	1.23	<b>1.2546</b>	V
$\Delta V_{OUT}/\Delta T$	Output Voltage Temperature Coefficient <sup>(6)</sup>			50		ppm/°C
$\Delta V_{OUT}/V_{OUT}$	Line Regulation	$V_{IN} = V_{OUT} + 1V$ to 30V		0.2	0.5	%
$\Delta V_{OUT}/V_{OUT}$	Load Regulation	$I_{OUT} = 100\mu A$ to 50mA <sup>(7)</sup>		0.15	0.3	%
		$I_{OUT} = 100\mu A$ to 150mA <sup>(7)</sup>		0.3	0.6	
$\Delta V$	Dropout Voltage <sup>(8)</sup>	$I_{OUT} = 100\mu A$		50	<b>120</b>	mV
		$I_{OUT} = 50mA$		230	<b>400</b>	
		$I_{OUT} = 100mA$		270		
		$I_{OUT} = 150mA$		320	<b>550</b>	
$I_{GND}$	Ground Pin Current	$V_{EN} = 2.0V$ , $I_{OUT} = 100\mu A$		20	<b>30</b>	$\mu A$
		$V_{EN} = 2.0V$ , $I_{OUT} = 50mA$		0.5	<b>0.9</b>	mA
		$V_{EN} = 2.0V$ , $I_{OUT} = 100mA$		1.5		
		$V_{EN} = 2.0V$ , $I_{OUT} = 150mA$		2.8	<b>5.0</b>	
$I_{GND}(SHDN)$	Ground Pin in Shutdown	$V_{EN} = 0V$ , $V_{IN} = 30V$		0.1	1	$\mu A$
$I_{SC}$	Short-Circuit Current	$V_{OUT} = 0V$	<b>150</b>	260	<b>400</b>	mA
$e_N$	Output Noise	10Hz to 100kHz, $V_{OUT} = 3.0V$ , $C_{OUT} = 2.2\mu F$		160		$\mu V_{RMS}$

**Notes:**

- Exceeding the absolute maximum rating may damage the device.
- The device is not guaranteed to function outside its operating rating.
- The maximum allowable power dissipation of any  $T_A$  (ambient temperature) is  $P_{D(MAX)} = (T_{J(MAX)} - T_A) \div \theta_{JA}$ . Exceeding the maximum allowable power dissipation will result in excessive die temperature, and the regulator will go into thermal shutdown.
- Devices are ESD sensitive. Handling precautions recommended. Human body model, 1.5k $\Omega$  in series with 100pF.
- Specification for packaged parts only.
- Output voltage temperature coefficient is defined as the worst-case voltage change divided by the total temperature range.
- Regulation is measured at constant junction temperature using pulse testing with a low duty cycle. Changes in output voltage due to heating effects are covered by the speculation for thermal regulation.
- Dropout voltage is defined as the input-to-output differential at which the output voltage drops 2% below its nominal value measured at  $V_{IN} = V_{OUT} + 1V$ .

**Electrical Characteristics<sup>(4)</sup> (Continued)**

$V_{IN} = V_{OUT} + 1V$ ;  $V_{EN} = 2.0V$ ;  $C_{OUT} = 4.7\mu F$ ;  $I_{OUT} = 100\mu A$ ;  $T_J = 25^\circ C$ , **bold** values indicate  $-40^\circ C \leq T_J \leq +125^\circ C$ , unless noted.

Symbol	Parameter	Condition	Min.	Typ.	Max.	Units
<b>Enable Input</b>						
$V_{IL}$	Input Low Voltage	Regulator off			<b>0.6</b>	<b>V</b>
$V_{IH}$	Input High Voltage	Regulator on	<b>2.0</b>			<b>V</b>
$I_{EN}$	Enable Input Current	$V_{EN} = 0.6V$ , regulator off		0.01	1.0	<b><math>\mu A</math></b>
					<b>2.0</b>	
		$V_{EN} = 2.0V$ , regulator on		0.15	1.0	
					<b>2.0</b>	
		$V_{EN} = 30V$ , regulator on		0.5	2.5	
					<b>5.0</b>	

# Typical Characteristics

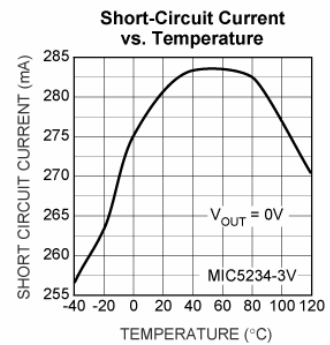
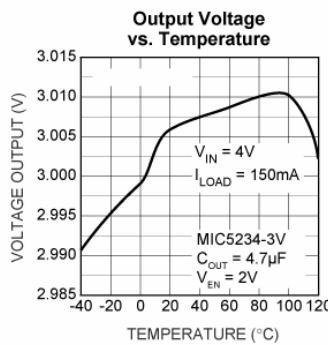
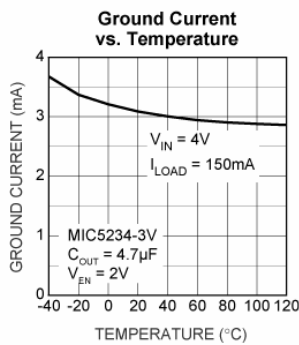
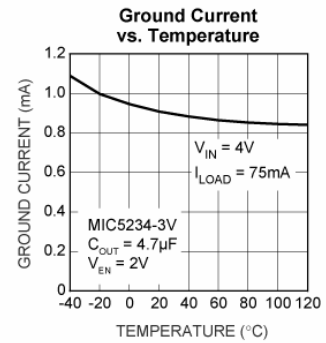
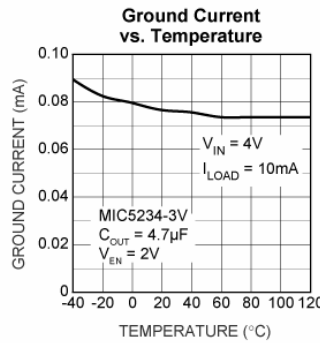
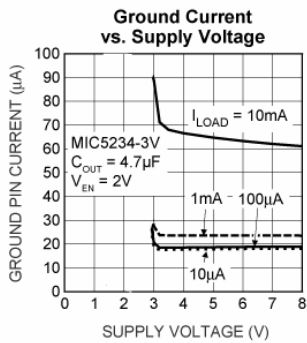
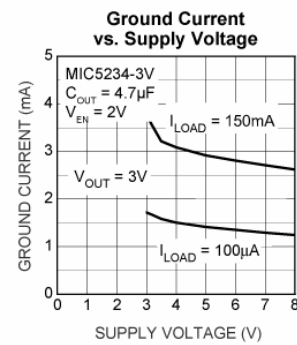
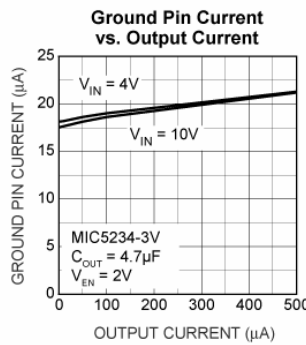
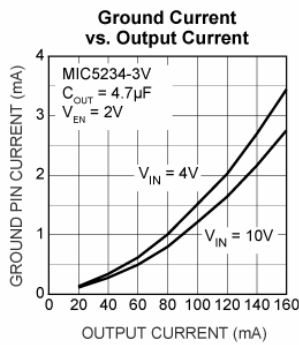
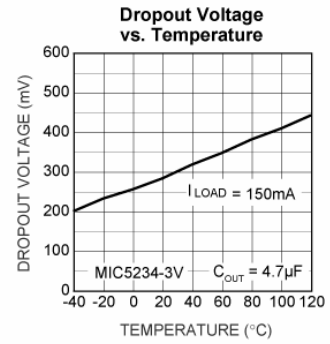
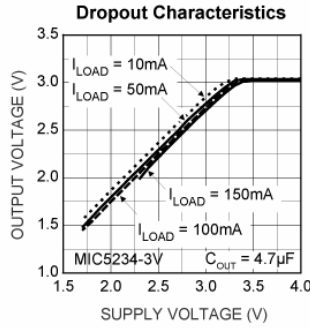
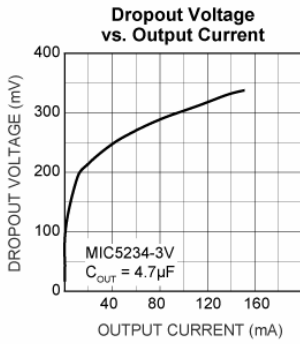

## Typical Characteristics (Continued)

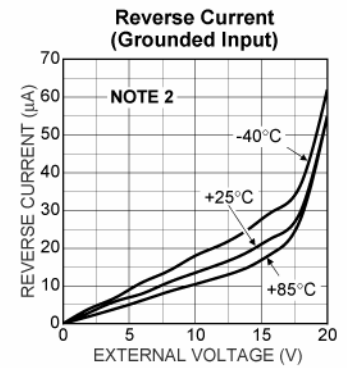
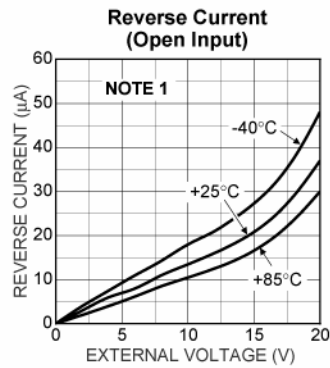
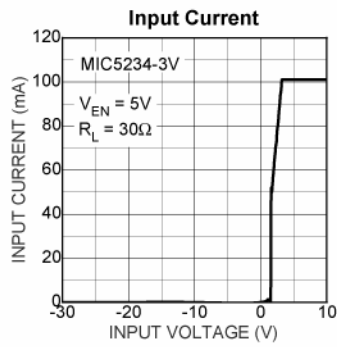
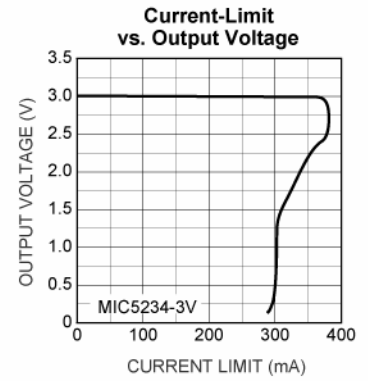
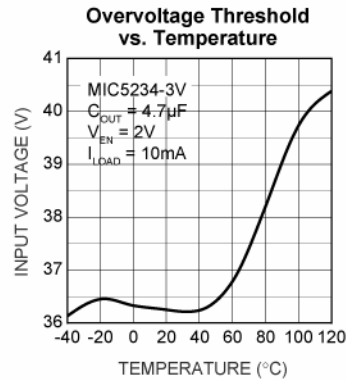
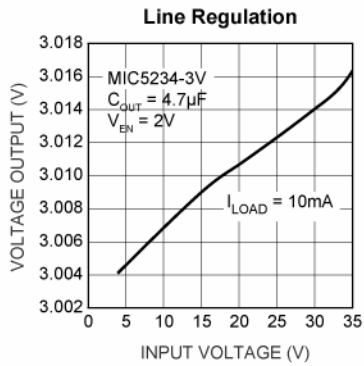

NOTE 1

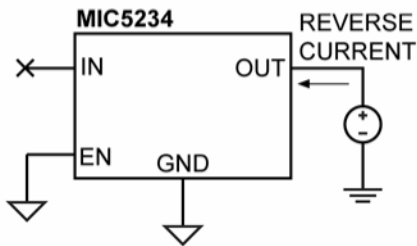

NOTE 2

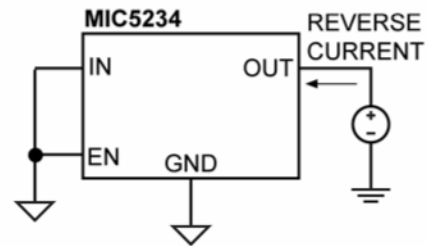

## Functional Characteristics

**Enable  
Turn-On Time**

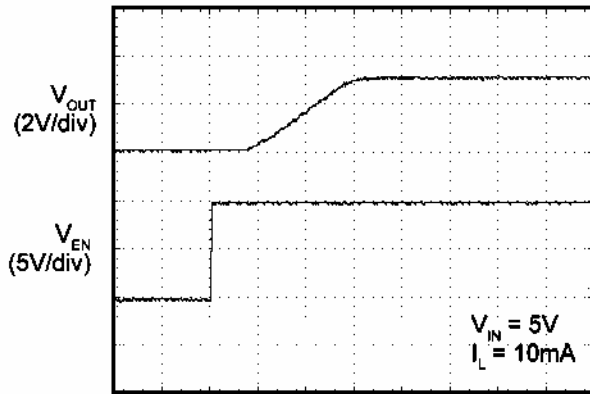

TIME (250 $\mu$ s/div)

**Load  
Transient Response**

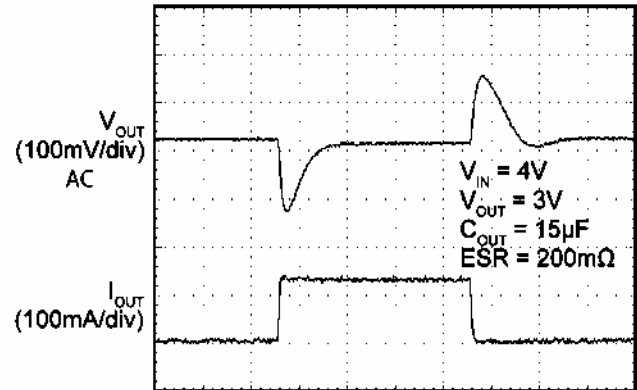

TIME (250 $\mu$ s/div)

**Line Transient**

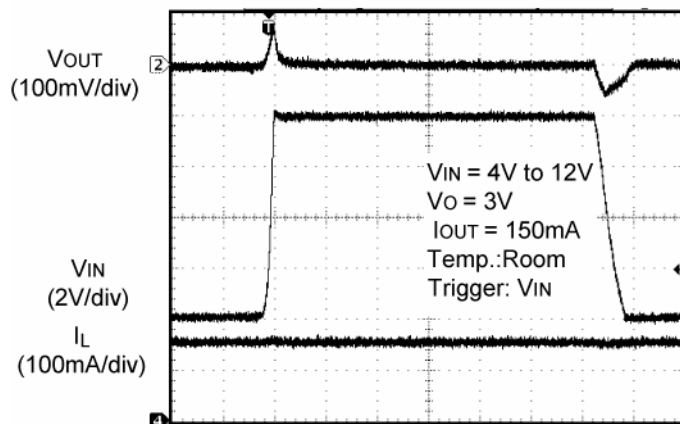

Time (100 $\mu$ s/div)

### Functional Diagram

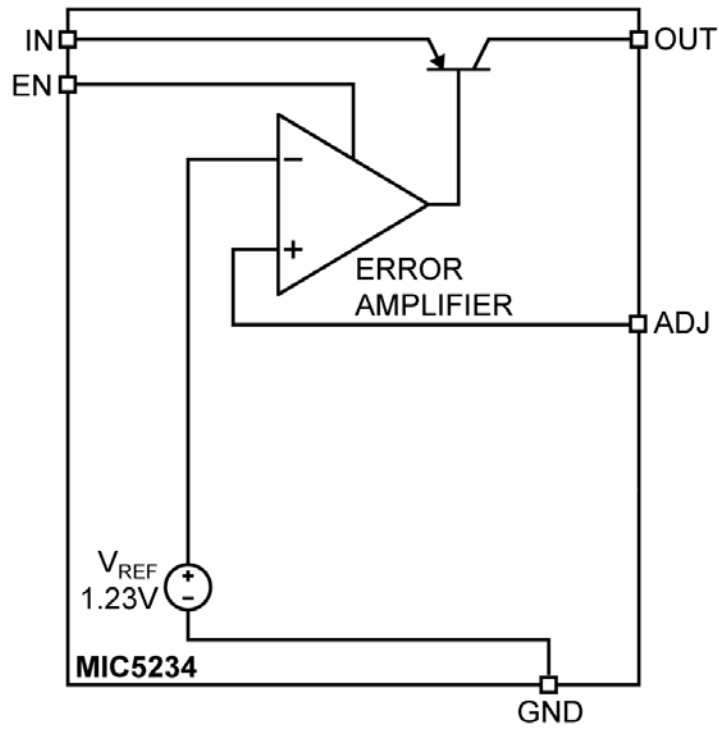



## Application Information

The MIC5234 is a  $\mu$ cap low dropout linear regulator which provides wide input voltage range, reversed-battery protection, reduced quiescent current and small package. When disabled, the quiescent current is reduced to 0.1 $\mu$ A.

### Enable

A low on the enable pin disables the part, forcing the quiescent current to less than 0.1 $\mu$ A. Thermal shutdown is not functional while the device is disabled. The maximum enable bias current is 2 $\mu$ A for a 2.0V input. An open collector pull-up resistor tied to the input voltage should be set low enough to maintain 2V on the enable input. Figure 1 shows an open collector output driving the enable pin through a 200k pull-up resistor tied to the input voltage. In order to avoid output oscillations, slow transitions from low to high should be avoided.

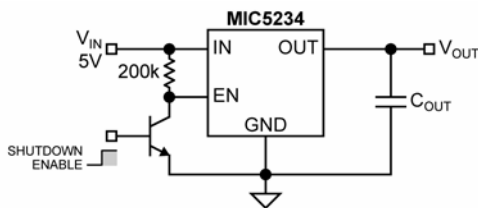

Figure 1. Remote Enable

### Input Capacitor

An input capacitor may be required when the device is not near the source power supply or when supplied by a battery. Small, surface mount, ceramic capacitors can be used for bypassing. Larger values may be required if the source supply has high ripple.

### Output Capacitor

The MIC5234 has been designed to minimize the effect of the output capacitor ESR on the closed loop stability. As a result, ceramic or film capacitors can be used at the output. Figure 2 displays a range of ESR values for a 10 $\mu$ F capacitor. A 10 $\mu$ F capacitor with an ESR less than 3.4 $\Omega$  is sufficient for stability over the entire input voltage range. Stability can also be maintained throughout the specified load and line conditions with 2.2 $\mu$ F film or ceramic capacitors.

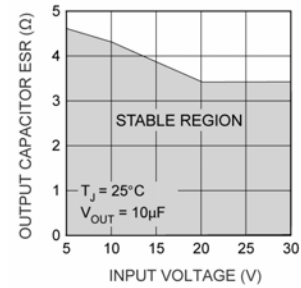

Figure 2. Output Capacitor ESR

### Reverse Current Protection

The MIC5234 is designed to limit the reverse current flow from output to input in the event that the MIC5234 output has been tied to the output of another power supply. Refer to the Typical Characteristics to see the graphs detailing the reverse current flow with the input grounded and open.

### Thermal Shutdown

The MIC5234 has integrated thermal protection. This feature is only for protection purposes. The device should never be intentionally operated near this temperature as this may have detrimental effects on the life of the device. The thermal shutdown may become inactive while the enable input is transitioning a high to a low. When disabling the device via the enable pin, transition from a high to low quickly. This will insure that the output remains disabled in the event of a thermal shutdown.

### ePad SOIC-8 Thermal Characteristics

The MIC5234 is a high input voltage device intended to provide 150mA of continuous output current in one a small profile package. The ePad SOIC-8 allows the device to dissipate approximately 50% more power than the SOIC-8 package.

The benefit of the MIC5234 ePad SOIC-8 package is an improvement to less than half the thermal resistance over the standard SO-8 packing. Lower thermal resistance means more output current or higher input voltage for a given package size. Lower thermal resistance is achieved by joining the die with the die attach paddle to create a single piece electrical and thermal conductor. This concept has been used by MOSFET manufacturers for years, proving very reliable and cost effective for the user. Thermal resistance consists of two main elements,  $\theta_{JC}$  (junction-to-case thermal resistance) and  $\theta_{CA}$  (case-to-ambient thermal resistance). See Figure 3.  $\theta_{JC}$  is the resistance from the die to the case (ePad) of the package.  $\theta_{CA}$  is the

resistance from the case (ePad) to the ambient air and it includes  $\theta_{CS}$  case (ePad)-to-sink thermal resistance and  $\theta_{SA}$  sink-to-ambient thermal resistance.

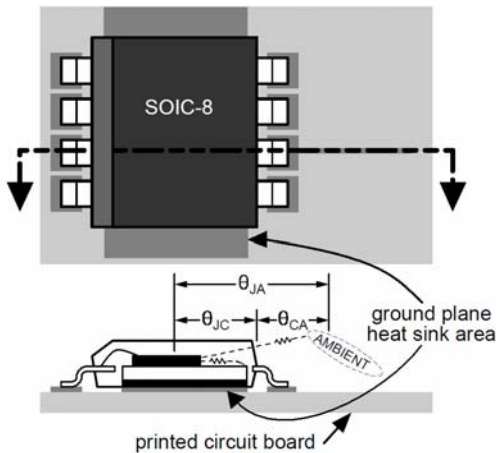

**Figure 3. Thermal Resistance**

Using the ePad SOIC-8 reduces the  $\theta_{JC}$  dramatically and allows the user to reduce  $\theta_{CA}$ . The total thermal resistance,  $\theta_{JA}$  (junction-to-ambient thermal resistance) is the limiting factor in calculating the maximum power dissipation capability of the device. Typically, the ePad SOIC-8 has a  $\theta_{JC}$  of 14.7°C/W, this is significantly lower than the standard SOIC-8 which is typically 48.8°C/W.  $\theta_{CA}$  is reduced because ePad can now be soldered directly to a ground plane which significantly reduces the case-to-sink thermal resistance and sink-to-ambient thermal resistance.

Low-dropout linear regulators from Micrel are rated to a maximum junction temperature of 125°C. It is important not to exceed this maximum junction temperature during operation of the device. To prevent this maximum junction temperature from being exceeded, the appropriate ground plane heat sink must be used.

The maximum allowable temperature rise must be calculated to determine the required heat sink:

$$\Delta T = T_{J(MAX)} - T_{A(MAX)}$$

$$T_{J(MAX)} = 125^{\circ}\text{C}$$

$$T_{A(MAX)} = \text{maximum ambient operating temperature}$$

For example, the maximum ambient temperature is 50°C, the  $\Delta T$  is determined as follows:

$$\Delta T = 125^{\circ}\text{C} - 50^{\circ}\text{C}$$

$$\Delta T = 75^{\circ}\text{C}$$

Power dissipation in a linear regulator is calculated as follows:

$$P_D = (V_{IN} - V_{OUT}) \times I_{OUT} + (V_{IN} \times I_{GND})$$

If we use a 3V output device and a 8V input with an output current of 150mA, then our power dissipation is as follows:

$$P_D = (8V - 3V) \times 150\text{mA} + (8V \times 2.6\text{mA})$$

$$P_D = 750\text{mW} + 20.8\text{mW}$$

$$P_D = 770.8\text{mW}$$

A copper plane should be provided to dissipate the heat to keep junction temperature 125°C.

**Adjustable Regulator Application**

The MIC5234 can be adjusted from 1.24V to 20V by using two external resistors (see Figure 4). The resistors set the output voltage based on Equation 1:

$$V_{OUT} = V_{REF} \times \left(1 + \frac{R1}{R2}\right) \tag{Eq. 1}$$

Where  $V_{REF} = 1.23\text{V}$ .

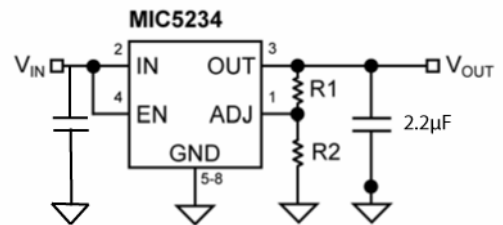

**Figure 4. Adjustable Voltage Application**

Example:

If output voltage to be set is 3.3V and R2 is selected as 1.2kΩ.

$$\text{Then } R1 = R2 \times \left(\frac{V_{OUT}}{V_{REF}} - 1\right)$$

$$R1 = 1.2\text{k}\Omega \times \left(\frac{3.3\text{V}}{1.23\text{V}} - 1\right) = 2.019 \text{ k}\Omega$$

## Evaluation Board Schematic

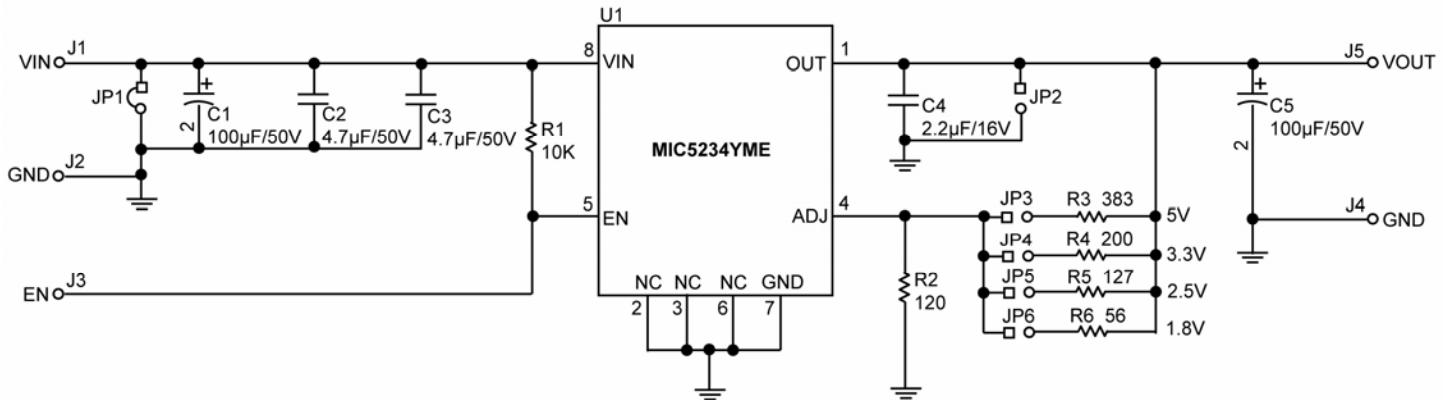

## Bill of Materials

Item	Part Number	Manufacturer	DESCRIPTION	Qty.
C1, C5	EKY-500ELL101MHB5D	United Chemi-con <sup>(1)</sup>	Capacitor, Aluminum, 100µF, 50V, 20%, Radial	2
C2, C3	12065C475KAT2A	AVX <sup>(2)</sup>	Capacitor, 4.7µF, 50V, X5R, size 1206	2
	GRM31CR71H475KA12L	Murata <sup>(3)</sup>		
	C3216X5R1H475K	TDK <sup>(4)</sup>		
C4	0805YD225KAT2A	AVX <sup>(2)</sup>	Capacitor, 2.2µF, 16V, X7R, size 0805	1
	GRM219R61C225KA88D	Murata <sup>(3)</sup>		
	C2012X7R1C225K	TDK <sup>(4)</sup>		
R1	CRCW060310K0FKEA	Vishay <sup>(5)</sup>	Resistor, 10KΩ, 1%, size 0603	1
R2	CRCW06031200FKEA	Vishay <sup>(5)</sup>	Resistor, 120Ω, 1%, size 0603	1
R3	CRCW06033830FKEA	Vishay <sup>(5)</sup>	Resistor, 383Ω, 1%, size 0603	1
R4	CRCW06032000FKEA	Vishay <sup>(5)</sup>	Resistor, 200Ω, 1%, size 0603	1
R5	CRCW06031270FKEA	Vishay <sup>(5)</sup>	Resistor, 127Ω, 1%, size 0603	1
R6	CRCW060356R0FKEA	Vishay <sup>(5)</sup>	Resistor, 56Ω, 1%, size 0603	1
U1	MIC5234YME	Micrel <sup>(6)</sup>	Low-Quiescent Current µCap LDO Regulator	1

### Notes:

1. United Chemi-Con: [www.chemi-con.com](http://www.chemi-con.com).
2. AVX: [www.avx.com](http://www.avx.com).
3. Murata: [www.murata.com](http://www.murata.com).
4. TDK: [www.tdk.com](http://www.tdk.com).
5. Vishay: [www.vishay.com](http://www.vishay.com).
6. Micrel, Inc.: [www.micrel.com](http://www.micrel.com).

### PCB Layout Recommendations

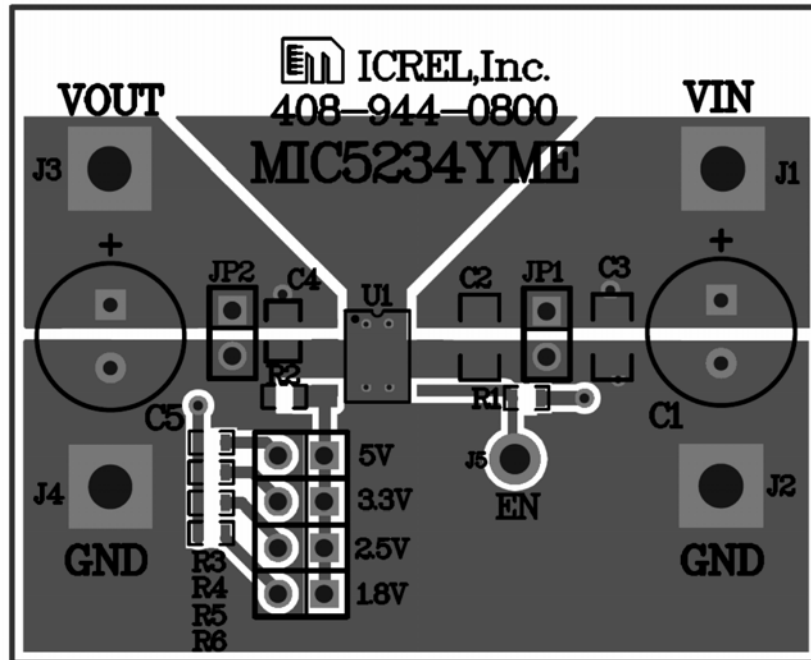

MIC5234 Evaluation Board Top Layer

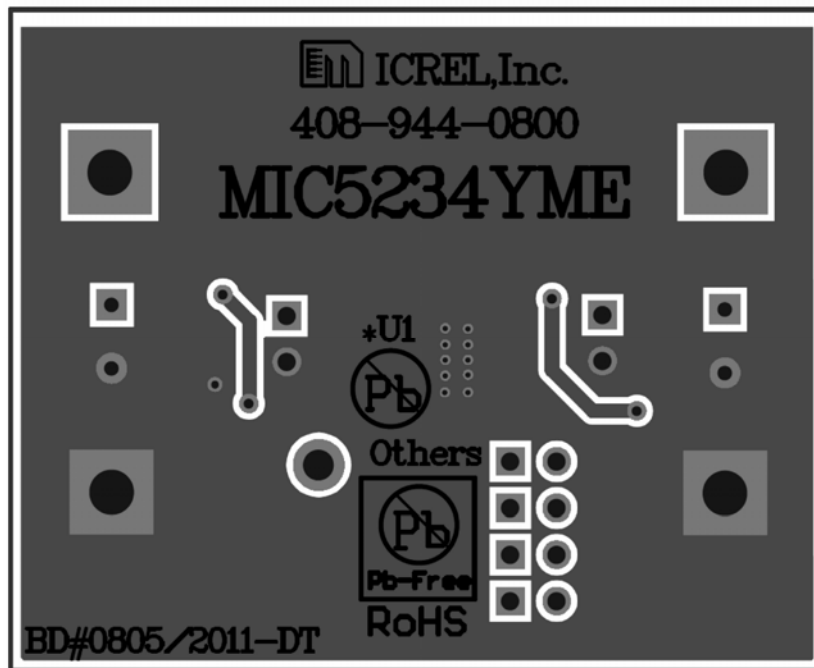

MIC5234 Evaluation Board Bottom Layer

PCB Layout Recommendations (Continued)

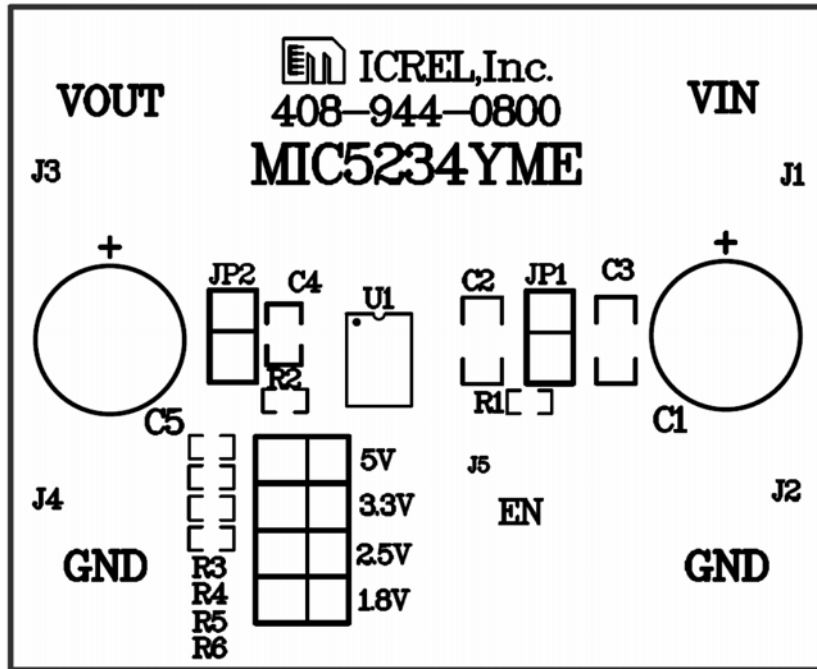

MIC5234 Evaluation Board Top Silk

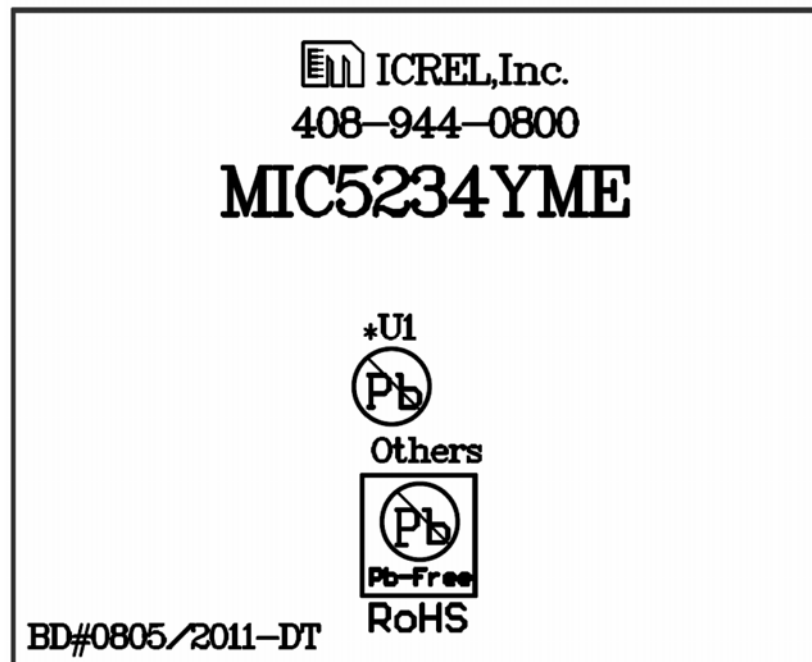

MIC5234 Evaluation Board Bottom Silk

Package Information

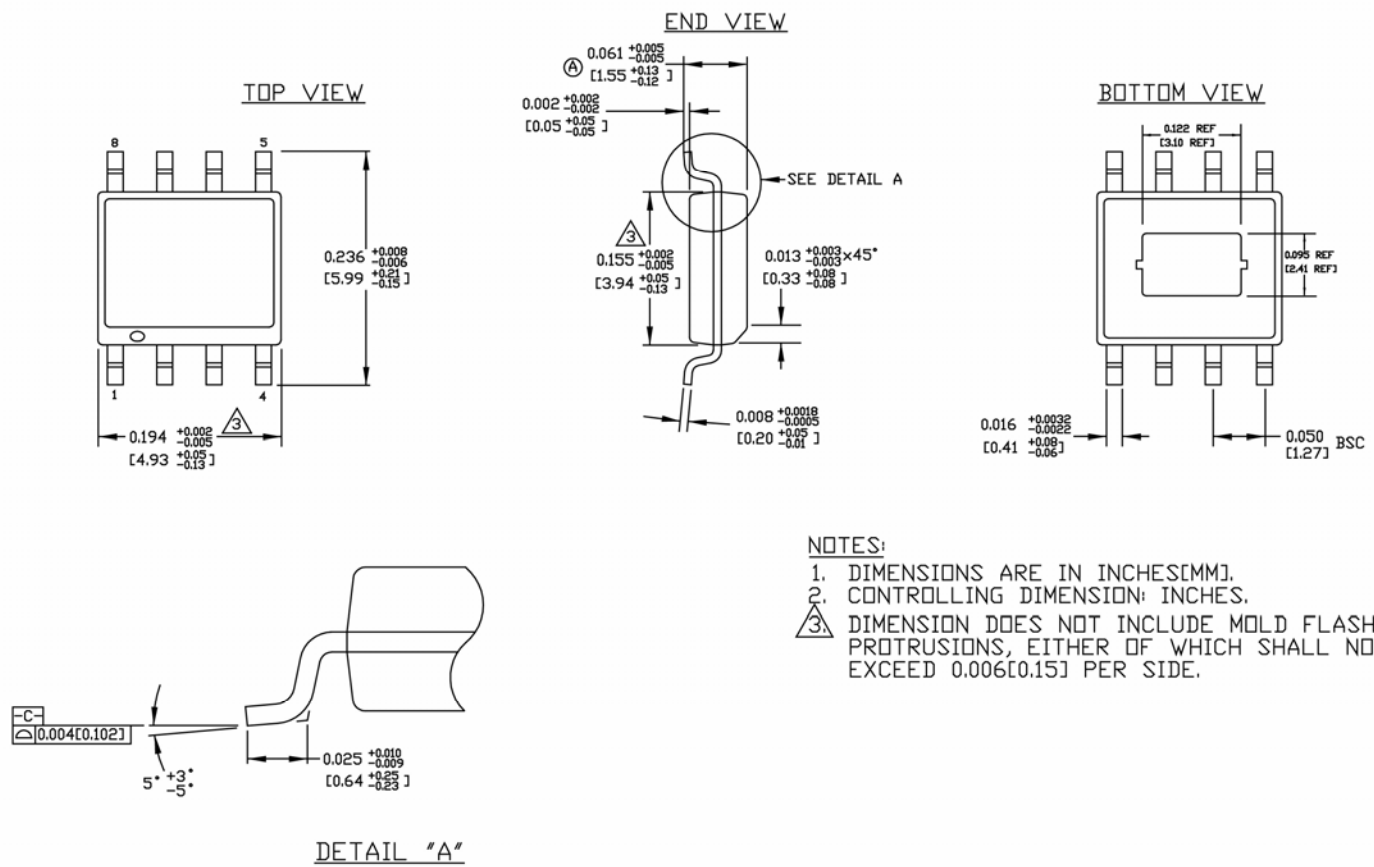

NOTES:

1. DIMENSIONS ARE IN INCHES[MM].
2. CONTROLLING DIMENSION: INCHES.
3. DIMENSION DOES NOT INCLUDE MOLD FLASH OR PROTRUSIONS, EITHER OF WHICH SHALL NOT EXCEED 0.006[0.15] PER SIDE.

8-Pin ePad SOIC (NE)

### Recommended Land Pattern

LP # SOICNEP-8LD-LP-1  
 All units are in inches  
 Tolerance  $\pm 0.05$  if not noted

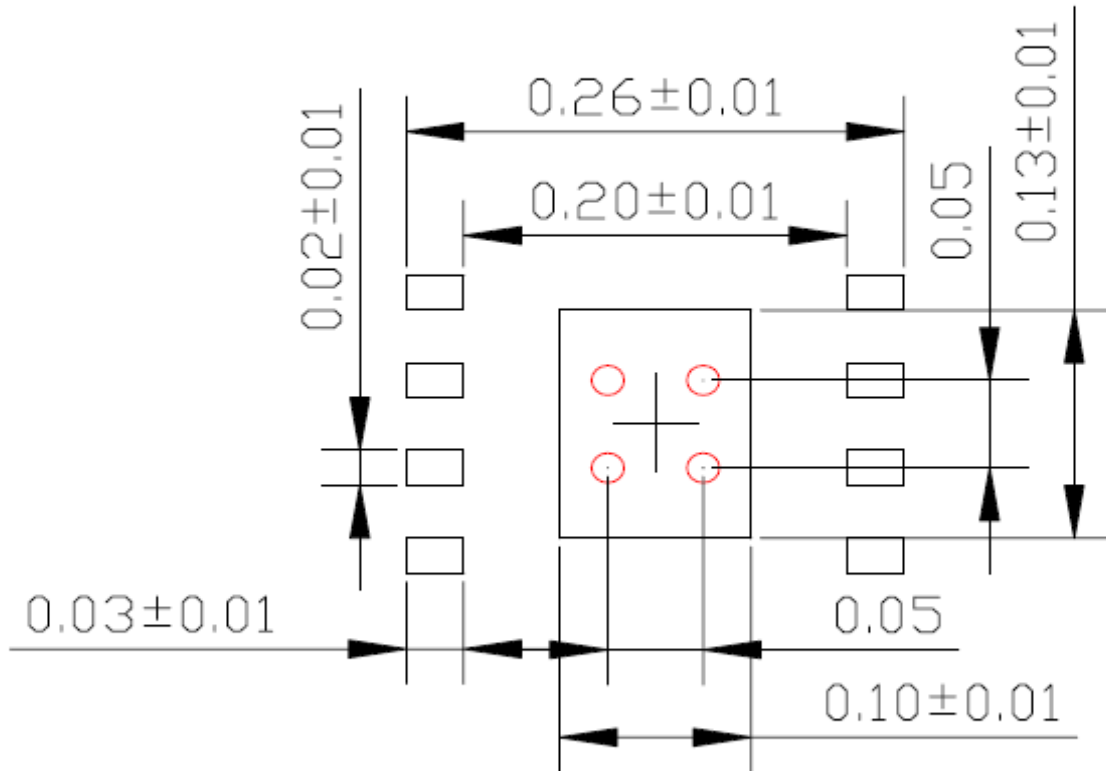

Red circle indicates Thermal Via. Size should be .015-.017 inches in diameter and it should be connected to GND plane for maximum thermal performance.

8-Pin ePad SOIC (NE)

---

**MICREL, INC. 2180 FORTUNE DRIVE SAN JOSE, CA 95131 USA**  
TEL +1 (408) 944-0800 FAX +1 (408) 474-1000 WEB <http://www.micrel.com>

Micrel makes no representations or warranties with respect to the accuracy or completeness of the information furnished in this data sheet. This information is not intended as a warranty and Micrel does not assume responsibility for its use. Micrel reserves the right to change circuitry, specifications and descriptions at any time without notice. No license, whether express, implied, arising by estoppel or otherwise, to any intellectual property rights is granted by this document. Except as provided in Micrel's terms and conditions of sale for such products, Micrel assumes no liability whatsoever, and Micrel disclaims any express or implied warranty relating to the sale and/or use of Micrel products including liability or warranties relating to fitness for a particular purpose, merchantability, or infringement of any patent, copyright or other intellectual property right.

Micrel Products are not designed or authorized for use as components in life support appliances, devices or systems where malfunction of a product can reasonably be expected to result in personal injury. Life support devices or systems are devices or systems that (a) are intended for surgical implant into the body or (b) support or sustain life, and whose failure to perform can be reasonably expected to result in a significant injury to the user. A Purchaser's use or sale of Micrel Products for use in life support appliances, devices or systems is a Purchaser's own risk and Purchaser agrees to fully indemnify Micrel for any damages resulting from such use or sale.

© 2011 Micrel, Incorporated.



## X-ON Electronics

Largest Supplier of Electrical and Electronic Components

*Click to view similar products for [LDO Voltage Regulators](#) category:*

*Click to view products by [Micrel](#) manufacturer:*

Other Similar products are found below :

[AP7363-SP-13](#) [L79M05TL-E](#) [PT7M8202B12TA5EX](#) [TCR3DF185,LM\(CT](#) [TCR3DF24,LM\(CT](#) [TCR3DF285,LM\(CT](#) [TCR3DF31,LM\(CT](#)  
[TCR3DF45,LM\(CT](#) [MP2013GQ-33-Z](#) [059985X](#) [NCP4687DH15T1G](#) [701326R](#) [TCR2EN28,LF\(S](#) [NCV8170AXV250T2G](#)  
[TCR3DF27,LM\(CT](#) [TCR3DF19,LM\(CT](#) [TCR3DF125,LM\(CT](#) [TCR2EN18,LF\(S](#) [AP7315-25W5-7](#) [IFX30081LDVGRNXUMA1](#)  
[NCV47411PAAJR2G](#) [AP2113KTR-G1](#) [AP2111H-1.2TRG1](#) [ZLDO1117QK50TC](#) [AZ1117IH-1.8TRG1](#) [TCR3DG12,LF](#) [MIC5514-3.3YMT-](#)  
[T5](#) [MIC5512-1.2YMT-T5](#) [MIC5317-2.8YM5-T5](#) [SCD7912BTG](#) [NCP154MX180270TAG](#) [SCD33269T-5.0G](#) [NCV8170BMX330TCG](#)  
[NCV8170AMX120TCG](#) [NCP706ABMX300TAG](#) [NCP153MX330180TCG](#) [NCP114BMX075TCG](#) [MC33269T-3.5G](#) [CAT6243-ADJCMT5T](#)  
[TCR3DG33,LF](#) [AP2127N-1.0TRG1](#) [TCR4DG35,LF](#) [LT1117CST-3.3](#) [LT1117CST-5](#) [TAR5S15U\(TE85L,F\)](#) [TAR5S18U\(TE85L,F\)](#)  
[TCR3UG19A,LF](#) [TCR4DG105,LF](#) [NCV8170AMX360TCG](#) [MIC94310-NYMT-T5](#)