

- 1N4565AUR-1 THRU 1N4584AUR-1 AVAILABLE IN JAN, JANTX, JANTXV AND JANS PER MIL-PRF-19500/452
- TEMPERATURE COMPENSATED ZENER REFERENCE DIODES
- LEADLESS PACKAGE FOR SURFACE MOUNT
- LOW CURRENT OPERATING RANGE: 0.5 TO 4.0 mA
- METALLURGICALLY BONDED, DOUBLE PLUG CONSTRUCTION

1N4565AUR-1 thru 1N4584AUR-1  
and  
CDLL4565 thru CDLL4584A

### MAXIMUM RATINGS

Operating Temperature: -65°C to +175°C  
Storage Temperature: -65°C to +175°C  
DC Power Dissipation: 500mW @ +50°C  
Power Derating: 4 mW / °C above +50°C

### REVERSE LEAKAGE CURRENT

IR = 2µA @ 25°C & VR = 3Vdc

ELECTRICAL CHARACTERISTICS @ 25°C, unless otherwise specified.

CDI TYPE NUMBER	ZENER TEST CURRENT I <sub>ZT</sub>	EFFECTIVE TEMPERATURE COEFFICIENT	VOLTAGE TEMPERATURE STABILITY <sup>3</sup> V <sub>ZT</sub> MAX -55° to + 100° (Note 1)	TEMPERATURE RANGE	MAX.DYNAMIC ZENER IMPEDANCE Z <sub>ZT</sub> (Note 2)
	mA	%/°C	mV	°C	OHMS
CDLL4565 CDLL4565A	.5 .5	.01 .01	48 100	0 to + 75°C -55 to + 100°C	200 200
CDLL4566 CDLL4566A	.5 .5	.005 .005	24 50	0 to + 75°C -55 to + 100°C	200 200
CDLL4567 CDLL4567A	.5 .5	.002 .002	10 20	0 to + 75°C -55 to + 100°C	200 200
CDLL4568 CDLL4568A	.5 .5	.001 .001	5 10	0 to + 75°C -55 to + 100°C	200 200
CDLL4569 CDLL4569A	.5 .5	.0005 .0005	2.5 5	0 to + 75°C -55 to + 100°C	200 200
CDLL4570 CDLL4570A	1.0 1.0	.01 .01	48 100	0 to + 75°C -55 to + 100°C	100 100
CDLL4571 CDLL4571A	1.0 1.0	.005 .005	24 50	0 to + 75°C -55 to + 100°C	100 100
CDLL4572 CDLL4572A	1.0 1.0	.002 .002	10 20	0 to + 75°C -55 to + 100°C	100 100
CDLL4573 CDLL4573A	1.0 1.0	.001 .001	5 10	0 to + 75°C -55 to + 100°C	100 100
CDLL4574 CDLL4574A	1.0 1.0	.0005 .0005	2.5 5	0 to + 75°C -55 to + 100°C	100 100
CDLL4575 CDLL4575A	2.0 2.0	.01 .01	48 100	0 to + 75°C -55 to + 100°C	50 50
CDLL4576 CDLL4576A	2.0 2.0	.005 .005	24 50	0 to + 75°C -55 to + 100°C	50 50
CDLL4577 CDLL4577A	2.0 2.0	.002 .002	10 20	0 to + 75°C -55 to + 100°C	50 50
CDLL4578 CDLL4578A	2.0 2.0	.001 .001	5 10	0 to + 75°C -55 to + 100°C	50 50
CDLL4579 CDLL4579A	2.0 2.0	.0005 .0005	2.5 5	0 to + 75°C -55 to + 100°C	50 50
CDLL4580 CDLL4580A	4.0 4.0	.01 .01	48 100	0 to + 75°C -55 to + 100°C	25 25
CDLL4581 CDLL4581A	4.0 4.0	.005 .005	24 50	0 to + 75°C -55 to + 100°C	25 25
CDLL4582 CDLL4582A	4.0 4.0	.002 .002	10 20	0 to + 75°C -55 to + 100°C	25 25
CDLL4583 CDLL4583A	4.0 4.0	.001 .001	5 10	0 to + 75°C -55 to + 100°C	25 25
CDLL4584 CDLL4584A	4.0 4.0	.0005 .0005	2.5 5	0 to + 75°C -55 to + 100°C	25 25

**NOTE 1** The maximum allowable change observed over the entire temperature range i.e., the diode voltage will not exceed the specified mV at any discrete temperature between the established limits, per JEDEC standard No.5.

**NOTE 2** Zener impedance is derived by superimposing on I<sub>ZT</sub> A 60Hz rms a.c. current equal to 10% of I<sub>ZT</sub>.

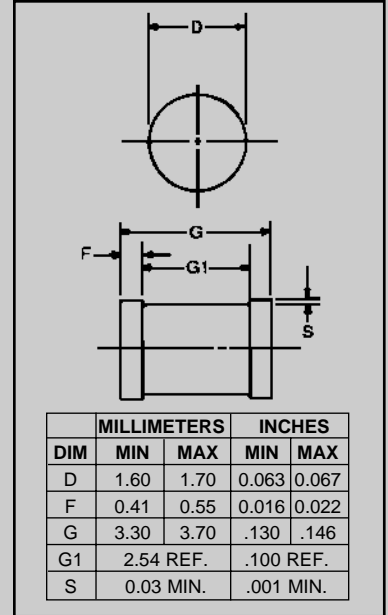

FIGURE 1

### DESIGN DATA

**CASE:** DO-213AA, Hermetically sealed glass case. (MELF, SOD-80, LL34)

**LEAD FINISH:** Tin / Lead

**POLARITY:** Diode to be operated with the banded (cathode) end positive.

**MOUNTING POSITION:** Any.

**MOUNTING SURFACE SELECTION:**  
The Axial Coefficient of Expansion (COE) of this Device is Approximately +6PPM/°C. The COE of the Mounting Surface System Should Be Selected To Provide A Suitable Match With This Device.



# CDLL4565 thru CDLL4584A

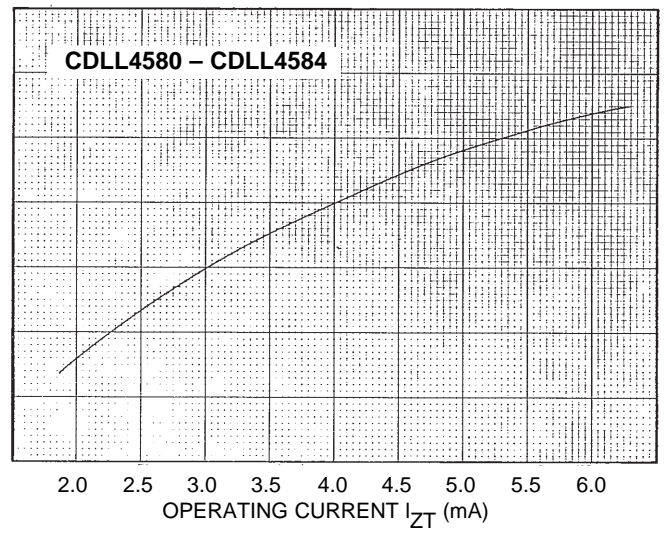
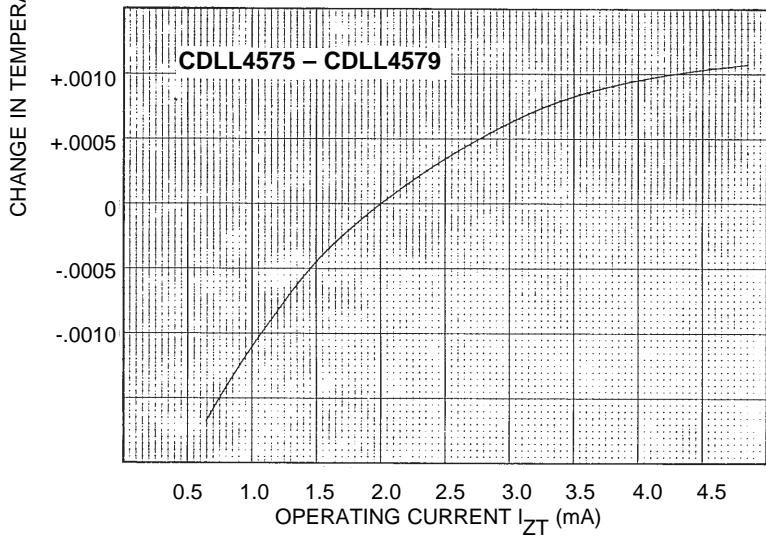
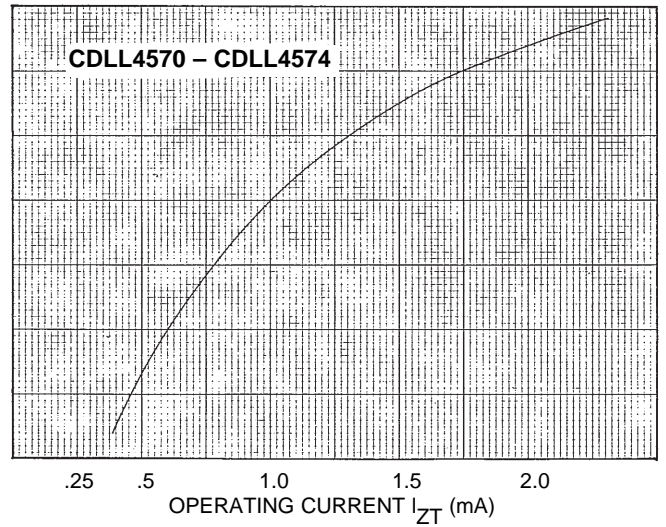
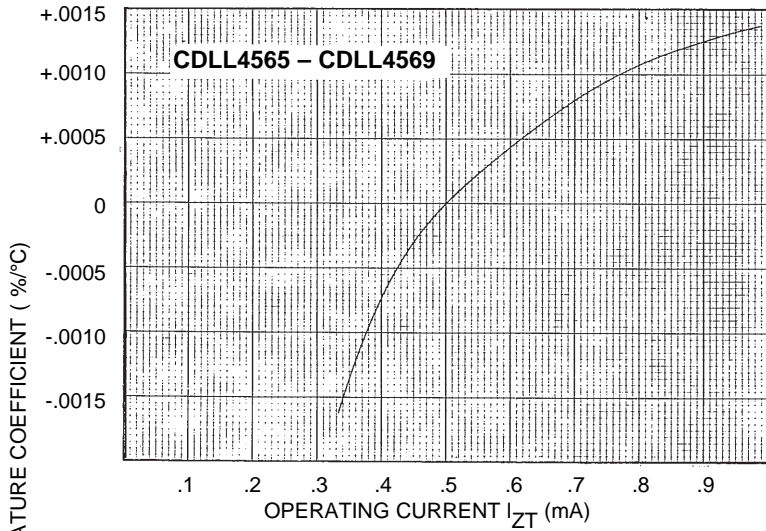

**TYPICAL CHANGE OF TEMPERATURE COEFFICIENT WITH CHANGE IN OPERATING CURRENT**

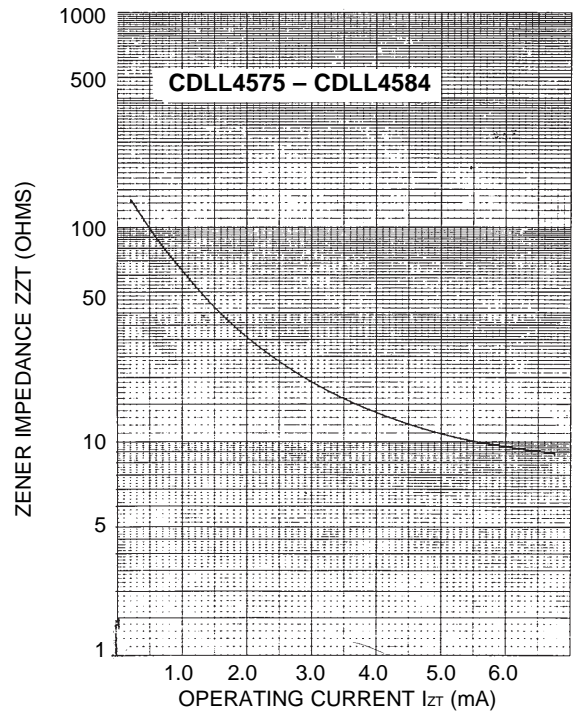
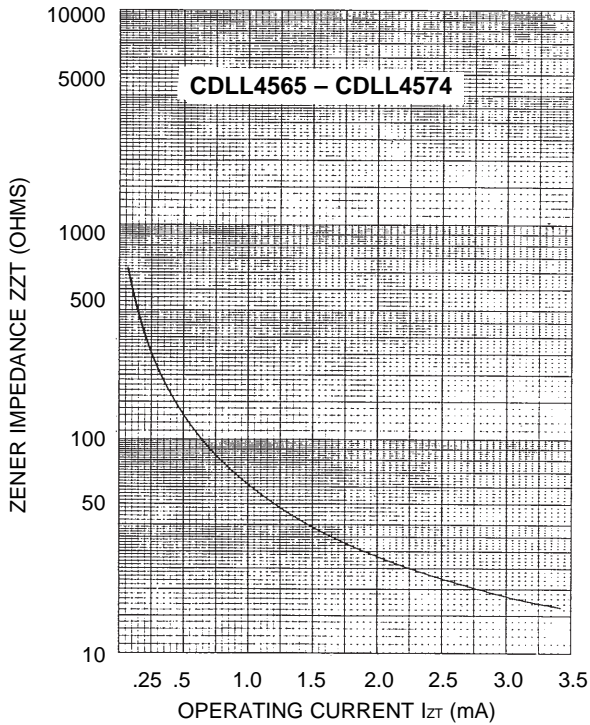

**ZENER IMPEDANCE VS. OPERATING CURRENT**

## X-ON Electronics

Largest Supplier of Electrical and Electronic Components

*Click to view similar products for [Zener Diodes](#) category:*

*Click to view products by [Microchip](#) manufacturer:*

Other Similar products are found below :

[RKZ13B2KG#P1](#) [DL5234B](#) [1N4682](#) [1N4691](#) [1N4693](#) [1N4732A](#) [1N4733A-TR](#) [1N4736A](#) [1N4759ARL](#) [1N5241B](#) [1N5365B](#) [1N5369B](#)  
[1N959B](#) [1N964B](#) [1N966B](#) [1N972B](#) [NTE149A](#) [NTE5116A](#) [NTE5121A](#) [NTE5147A](#) [NTE5152A](#) [NTE5155A](#) [NTE5164A](#) [JANS1N4974US](#)  
[1N4692](#) [1N4700](#) [1N4702](#) [1N4704](#) [1N4711](#) [1N4714](#) [1N4737A](#) [1N4745ARL](#) [1N4752A](#) [1N4752ARL](#) [1N4760ARL](#) [1N5221B](#) [1N5236B](#)  
[1N5241BTR](#) [1N5242BTR](#) [1N5350B](#) [1N5352B](#) [1N961BRR1](#) [1N964BRL](#) [RKZ5.1BKU#P6](#) [3SMAJ5950B-TP](#) [3SMBJ5925B-TP](#) [TDZTR24](#)  
[441774C](#) [MMSZ5230BQ-13-F](#) [MMSZ5232BQ-13-F](#)