

PIC32 Audio Codec Daughter Board – AK4954 Information Sheet

Thank you for purchasing a PIC32 Audio Codec Daughter Board, AK4954 (AC324954). This information sheet provides important information that will help you successfully use the daughter board as quickly as possible.

The PIC32 Audio Codec Daughter Board – AK4954 is based on the AKM AK4954 codec. This information sheet provides an overview as well as detailed schematics of the board.

This daughter board is designed specifically to be used with the PIC32 Bluetooth® Audio Development kit (DV320032); however, it can also be used with other Microchip development hardware.

Visit <http://www.microchip.com> for additional information on the PIC32 Audio Codec Daughter Board

Features

The PIC32 Audio Codec Daughter Board – AK4954 is a high-performance stereo codec board for select PIC32 hardware development platforms. This board features the AKM AK4954 stereo codec, including built-in microphone and headphone amplifiers. This board is suitable for adding audio input and output capabilities to the PIC32 Bluetooth Starter Kit (DM320018) and the PIC32 Bluetooth Audio Development Kit.

The PIC32 Audio Codec Daughter Board – AK4954 features include:

- AKM AK4954 codec
- MCP1801 power regulator
- On-board MEMS microphone
- 3.5 mm inputs and outputs:
 - Line in
 - External Mic in
 - Headphone out
- 32-bit I²S audio
- Up to 96 kHz audio sample rates
- Suitable for audio and voice, and utilized in Bluetooth applications
- X32 connection interface

Additional Information

For more information on drivers and examples, please visit:

- www.microchip.com/pic32btsuites
- www.microchip.com/harmony

Americas

Atlanta - 678-957-9614
Austin - 512-257-3370
Boston - 774-760-0087
Chicago - 630-285-0071
Cleveland - 216-447-0464
Dallas - 972-818-7423
Detroit - 248-848-4000
Houston - 281-894-5983
Indianapolis - 317-773-8323
Los Angeles - 949-462-9523
New York - 631-435-6000
Phoenix - 480-792-7200
Santa Clara - 408-961-6444
Toronto - 905-673-0699

Europe

Austria - Wels - 43-7242-2244-39
Denmark - Copenhagen - 45-4450-2828
France - Paris - 33-1-69-53-63-20
Germany - Munich - 49-89-627-144-0
Italy - Milan - 39-0331-742611
Netherlands - Drunen - 31-416-690399
Spain - Madrid - 34-91-708-08-90
UK - Wokingham - 44-118-921-5869

Asia/Pacific

Australia - Sydney - 61-2-9868-6733
China - Beijing - 86-10-8569-2100

Asia/Pacific (Continued)

China - Chengdu - 86-28-8665-5511
China - Chongqing - 86-23-8980-9588
China - Hangzhou - 86-571-8792-8115
China - Hong Kong SAR - 852-2943-5100
China - Nanjing - 86-25-8473-2460
China - Qingdao - 86-532-8502-7355
China - Shanghai - 86-21-5407-5533
China - Shenyang - 86-24-2334-2829
China - Shenzhen - 86-755-8864-2200
China - Wuhan - 86-27-5980-5300
China - Xiamen - 86-592-2388138
China - Xian - 86-29-8833-7252
China - Zhuhai - 86-756-3210040
India - Bangalore - 91-80-3090-4444
India - New Delhi - 91-11-4160-8631
India - Pune - 91-20-3019-1500
Japan - Osaka - 81-6-6152-7160
Japan - Tokyo - 81-3-6880-3770
Korea - Daegu - 82-53-744-4301
Korea - Seoul - 82-2-554-7200
Malaysia - Kuala Lumpur - 60-3-6201-9857
Malaysia - Penang - 60-4-227-8870
Philippines - Manila - 63-2-634-9065
Singapore - 65-6334-8870
Taiwan - Hsin Chu - 886-3-5778-366
Taiwan - Kaohsiung - 886-7-213-7840
Taiwan - Taipei - 886-2-2508-8600
Thailand - Bangkok - 66-2-694-1351

01/11/17



Microchip Technology Inc. • 2355 West Chandler Blvd. • Chandler, AZ 85224-6199

www.microchip.com

The Microchip name and logo, the Microchip logo, and MPLAB are registered trademarks of Microchip Technology Incorporated in the U.S.A. and other countries. All other trademarks mentioned herein are property of their respective companies. © 2014, Microchip Technology Incorporated, Printed in the U.S.A. All Rights Reserved. 01/17

DS50002658A



PIC32 Audio Codec Daughter Board – AK4954 Schematic

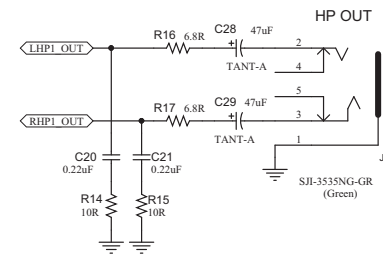
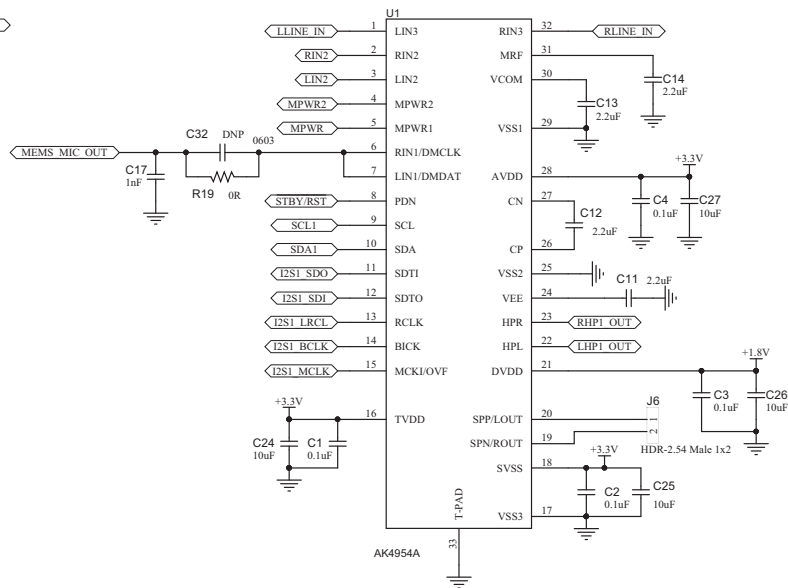
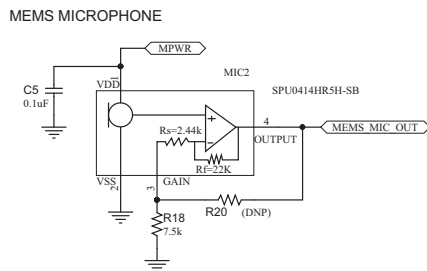
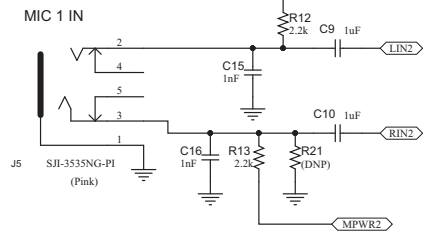
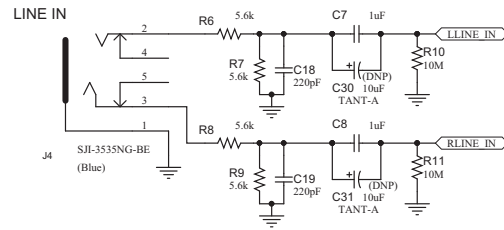
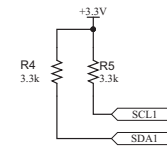
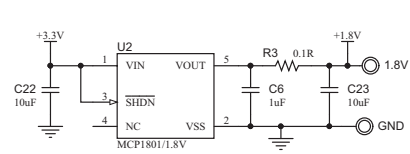
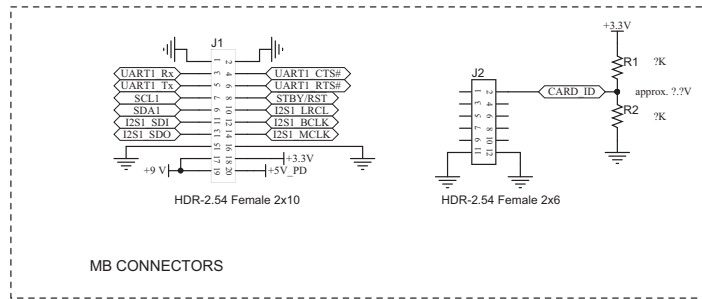

X-ON Electronics

Largest Supplier of Electrical and Electronic Components

Click to view similar products for [Daughter Cards & OEM Boards](#) category:

Click to view products by [Microchip](#) manufacturer:

Other Similar products are found below :

[ADZS-21262-1-EZEXT](#) [27911](#) [SPC56ELADPT144S](#) [TMDXRM46CNCD](#) [DM160216](#) [EV-ADUCM350GPIOHZ](#) [EV-ADUCM350-BIO3Z](#)
[ATSTK521](#) [1130](#) [MA160015](#) [MA180033](#) [MA240013](#) [MA240026](#) [MA320014](#) [MA330014](#) [MA330017](#) [TLK10034SMAEVM](#) [MIKROE-](#)
[2152](#) [MIKROE-2154](#) [MIKROE-2381](#) [TSSOP20EV](#) [DEV-11723](#) [MIKROE-1108](#) [MIKROE-1516](#) [SPS-READER-GEVK](#) [AC244049](#)
[AC244050](#) [AC320004-3](#) [2077](#) [ATSMARTCARD-XPRO](#) [EIC - Q600 -230](#) [ATZB-212B-XPRO](#) [SPC560PADPT100S](#) [SPC560BADPT64S](#)
[MA180018](#) [EIC - Q600 -220](#) [AC164134-1](#) [BOB-12035](#) [STM8/128-D/RAIS](#) [AC164127-6](#) [AC164127-4](#) [AC164134-3](#) [AC164156](#) [MA320021](#)
[MA320024](#) [DFR0285](#) [DFR0312](#) [DFR0356](#) [MA320023](#) [MIKROE-2564](#)