



MICROCHIP

**MCP37X10-200
12-Bit Single-Channel
Evaluation Kit
User's Guide**

Note the following details of the code protection feature on Microchip devices:

- Microchip products meet the specification contained in their particular Microchip Data Sheet.
- Microchip believes that its family of products is one of the most secure families of its kind on the market today, when used in the intended manner and under normal conditions.
- There are dishonest and possibly illegal methods used to breach the code protection feature. All of these methods, to our knowledge, require using the Microchip products in a manner outside the operating specifications contained in Microchip's Data Sheets. Most likely, the person doing so is engaged in theft of intellectual property.
- Microchip is willing to work with the customer who is concerned about the integrity of their code.
- Neither Microchip nor any other semiconductor manufacturer can guarantee the security of their code. Code protection does not mean that we are guaranteeing the product as "unbreakable."

Code protection is constantly evolving. We at Microchip are committed to continuously improving the code protection features of our products. Attempts to break Microchip's code protection feature may be a violation of the Digital Millennium Copyright Act. If such acts allow unauthorized access to your software or other copyrighted work, you may have a right to sue for relief under that Act.

Information contained in this publication regarding device applications and the like is provided only for your convenience and may be superseded by updates. It is your responsibility to ensure that your application meets with your specifications. MICROCHIP MAKES NO REPRESENTATIONS OR WARRANTIES OF ANY KIND WHETHER EXPRESS OR IMPLIED, WRITTEN OR ORAL, STATUTORY OR OTHERWISE, RELATED TO THE INFORMATION, INCLUDING BUT NOT LIMITED TO ITS CONDITION, QUALITY, PERFORMANCE, MERCHANTABILITY OR FITNESS FOR PURPOSE. Microchip disclaims all liability arising from this information and its use. Use of Microchip devices in life support and/or safety applications is entirely at the buyer's risk, and the buyer agrees to defend, indemnify and hold harmless Microchip from any and all damages, claims, suits, or expenses resulting from such use. No licenses are conveyed, implicitly or otherwise, under any Microchip intellectual property rights unless otherwise stated.

Microchip received ISO/TS-16949:2009 certification for its worldwide headquarters, design and wafer fabrication facilities in Chandler and Tempe, Arizona; Gresham, Oregon and design centers in California and India. The Company's quality system processes and procedures are for its PIC[®] MCUs and dsPIC[®] DSCs, KEELOQ[®] code hopping devices, Serial EEPROMs, microperipherals, nonvolatile memory and analog products. In addition, Microchip's quality system for the design and manufacture of development systems is ISO 9001:2000 certified.

**QUALITY MANAGEMENT SYSTEM
CERTIFIED BY DNV
= ISO/TS 16949 =**

Trademarks

The Microchip name and logo, the Microchip logo, AnyRate, dsPIC, FlashFlex, flexPWR, Heldo, JukeBlox, KeeLoq, KeeLoq logo, Klear, LANCheck, LINK MD, MediaLB, MOST, MOST logo, MPLAB, OptoLyzer, PIC, PICSTART, PIC32 logo, RightTouch, SpyNIC, SST, SST Logo, SuperFlash and UNI/O are registered trademarks of Microchip Technology Incorporated in the U.S.A. and other countries.

ClockWorks, The Embedded Control Solutions Company, ETHERSYNCH, Hyper Speed Control, HyperLight Load, IntelliMOS, mTouch, Precision Edge, and QUIET-WIRE are registered trademarks of Microchip Technology Incorporated in the U.S.A.

Analog-for-the-Digital Age, Any Capacitor, AnyIn, AnyOut, BodyCom, chipKIT, chipKIT logo, CodeGuard, dsPICDEM, dsPICDEM.net, Dynamic Average Matching, DAM, ECAN, EtherGREEN, In-Circuit Serial Programming, ICSP, Inter-Chip Connectivity, JitterBlocker, KlearNet, KlearNet logo, MiWi, motorBench, MPASM, MPF, MPLAB Certified logo, MPLIB, MPLINK, MultiTRAK, NetDetach, Omniscient Code Generation, PICDEM, PICDEM.net, PICkit, PICtail, PureSilicon, RightTouch logo, REAL ICE, Ripple Blocker, Serial Quad I/O, SQL, SuperSwitcher, SuperSwitcher II, Total Endurance, TSHARC, USBCheck, VariSense, ViewSpan, WiperLock, Wireless DNA, and ZENA are trademarks of Microchip Technology Incorporated in the U.S.A. and other countries.

SQTP is a service mark of Microchip Technology Incorporated in the U.S.A.

Silicon Storage Technology is a registered trademark of Microchip Technology Inc. in other countries.

GettIC is a registered trademarks of Microchip Technology Germany II GmbH & Co. KG, a subsidiary of Microchip Technology Inc., in other countries.

All other trademarks mentioned herein are property of their respective companies.

© 2016, Microchip Technology Incorporated, Printed in the U.S.A., All Rights Reserved.

ISBN: 978-1-5224-0889-5

Object of Declaration: MCP37X10-200 12-Bit Single-Channel Evaluation Kit

EU Declaration of Conformity

Manufacturer: Microchip Technology Inc.
2355 W. Chandler Blvd.
Chandler, Arizona, 85224-6199
USA

This declaration of conformity is issued by the manufacturer.

The development/evaluation tool is designed to be used for research and development in a laboratory environment. This development/evaluation tool is not a Finished Appliance, nor is it intended for incorporation into Finished Appliances that are made commercially available as single functional units to end users under EU EMC Directive 2004/108/EC and as supported by the European Commission's Guide for the EMC Directive 2004/108/EC (8th February 2010).

This development/evaluation tool complies with EU RoHS2 Directive 2011/65/EU.

This development/evaluation tool, when incorporating wireless and radio-telecom functionality, is in compliance with the essential requirement and other relevant provisions of the R&TTE Directive 1999/5/EC and the FCC rules as stated in the declaration of conformity provided in the module datasheet and the module product page available at www.microchip.com.

For information regarding the exclusive, limited warranties applicable to Microchip products, please see Microchip's standard terms and conditions of sale, which are printed on our sales documentation and available at www.microchip.com.

Signed for and on behalf of Microchip Technology Inc. at Chandler, Arizona, USA

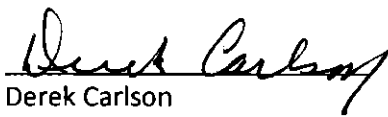
Derek Carlson
VP Development Tools

12-Sep-14
Date



MCP37X10-200 12-BIT SINGLE-CHANNEL EVALUATION KIT USER'S GUIDE

Table of Contents

Preface	5
Introduction.....	5
Document Layout	5
Conventions Used in this Guide	6
Recommended Reading.....	7
The Microchip Website.....	7
Customer Support	7
Document Revision History	7
Chapter 1. Product Overview	
1.1 Introduction	9
1.2 What is the MCP37X10-200 12-Bit Single-Channel Evaluation Board (ADM00735)?	9
1.3 What is the MCP37XXX High-Speed Pipeline ADC Data Capture Card (ADM00506)?	11
1.4 What is the Pipeline ADC Utility Software?	13
1.5 MCP37X10-200 12-Bit Single-Channel Evaluation Kit Requirements	14
Chapter 2. Installation and Operation	
2.1 MCP37X10-200 12-Bit Single-Channel Evaluation Kit Features	15
2.2 Getting Started	15
2.2.1 Configuration Requirements	15
2.2.2 Power Input Connection	15
2.2.3 Evaluation Kit Set-Up	16
2.2.4 Input/Output Optimization	17
Appendix A. Schematics and Layouts	21
Appendix B. Bill of Materials (BOM)	23
Worldwide Sales and Service	24



MCP37X10-200 12-BIT SINGLE-CHANNEL EVALUATION KIT USER'S GUIDE

Preface

NOTICE TO CUSTOMERS

All documentation becomes dated, and this manual is no exception. Microchip tools and documentation are constantly evolving to meet customer needs, so some actual dialogs and/or tool descriptions may differ from those in this document. Please refer to our website (www.microchip.com) to obtain the latest documentation available.

Documents are identified with a “DS” number. This number is located on the bottom of each page, in front of the page number. The numbering convention for the DS number is “DSXXXXXXXXA”, where “XXXXXXXX” is the document number and “A” is the revision level of the document.

For the most up-to-date information on development tools, see the MPLAB® IDE online help. Select the Help menu, and then Topics to open a list of available online help files.

INTRODUCTION

This chapter contains general information that will be useful to know before using the MCP37X10-200 12-Bit Single-Channel Evaluation Kit. Items discussed in this chapter include:

- Document Layout
- Conventions Used in this Guide
- Recommended Reading
- The Microchip Website
- Customer Support
- Document Revision History

DOCUMENT LAYOUT

This document describes how to use the MCP37X10-200 12-Bit Single-Channel Evaluation Kit to demonstrate the performance of the MCP37X10-200 device family. The manual layout is as follows:

- **Chapter 1. “Product Overview”** – Important information about the MCP37X10-200 12-Bit Single-Channel Evaluation Kit.
- **Chapter 2. “Installation and Operation”** – Includes instructions on how to get started with the MCP37X10-200 12-Bit Single-Channel Evaluation Kit.
- **Appendix A. “Schematics and Layouts”** – Refer to the board's web page for the complete Schematics and Layouts.
- **Appendix B. “Bill of Materials (BOM)”** – Refer to the board's web page for the complete Bill of Materials.

CONVENTIONS USED IN THIS GUIDE

This manual uses the following documentation conventions:

DOCUMENTATION CONVENTIONS

Description	Represents	Examples
Arial font:		
Italic characters	Referenced books	<i>MPLAB[®] IDE User's Guide</i>
	Emphasized text	...is the <i>only</i> compiler...
Initial caps	A window	the Output window
	A dialog	the Settings dialog
	A menu selection	select Enable Programmer
Quotes	A field name in a window or dialog	"Save project before build"
Underlined, Italic text with right angle bracket	A menu path	<u><i>File>Save</i></u>
Bold characters	A dialog button	Click OK
	A tab	Click the Power tab
N'Rnnnn	A number in verilog format, where N is the total number of digits, R is the radix and n is a digit.	4'b0010, 2'hF1
Text in angle brackets < >	A key on the keyboard	Press <Enter>, <F1>
Courier New font:		
Plain Courier New	Sample source code	#define START
	Filenames	autoexec.bat
	File paths	c:\mcc18\h
	Keywords	_asm, _endasm, static
	Command-line options	-Opa+, -Opa-
	Bit values	0, 1
	Constants	0xFF, 'A'
Italic Courier New	A variable argument	<i>file.o</i> , where <i>file</i> can be any valid filename
Square brackets []	Optional arguments	mcc18 [options] <i>file</i> [options]
Curly brackets and pipe character: { }	Choice of mutually exclusive arguments; an OR selection	errorlevel {0 1}
Ellipses...	Replaces repeated text	var_name [, var_name...]
	Represents code supplied by user	void main (void) { ... }

RECOMMENDED READING

This user's guide describes how to use the MCP37X10-200 12-Bit Single-Channel Evaluation Kit. Other useful documents are listed below. The following Microchip documents are available and recommended as supplemental reference resources.

- **MCP37210-D10 Data Sheet – “200 Msps, 12-Bit Low-Power Single-Channel ADC” (DS20005395)**

THE MICROCHIP WEBSITE

Microchip provides online support via our website at www.microchip.com. This website is used as a means to make files and information easily available to customers. Accessible by using your favorite Internet browser, the website contains the following information:

- **Product Support** – Data sheets and errata, application notes and sample programs, design resources, user's guides and hardware support documents, latest software releases and archived software
- **General Technical Support** – Frequently Asked Questions (FAQs), technical support requests, online discussion groups, Microchip consultant program member listing
- **Business of Microchip** – Product selector and ordering guides, latest Microchip press releases, listing of seminars and events, listings of Microchip sales offices, distributors and factory representatives

CUSTOMER SUPPORT

Users of Microchip products can receive assistance through several channels:

- Distributor or Representative
- Local Sales Office
- Field Application Engineer (FAE)
- Technical Support

Customers should contact their distributor, representative or field application engineer (FAE) for support. Local sales offices are also available to help customers. A listing of sales offices and locations is included in the back of this document.

Technical support is available through the website at:
<http://www.microchip.com/support>.

DOCUMENT REVISION HISTORY

Revision A (August 2016)

- Initial release of this document.

NOTES:

Chapter 1. Product Overview

1.1 INTRODUCTION

This chapter provides an overview of the MCP37X10-200 12-Bit Single-Channel Evaluation Board (ADM00735) and covers the following topics:

- What is the MCP37X10-200 12-Bit Single-Channel Evaluation Board (ADM00735)?
- What is the MCP37XXX High-Speed Pipeline ADC Data Capture Card (ADM00506)?
- What is the Pipeline ADC Utility Software?
- MCP37X10-200 12-Bit Single-Channel Evaluation Kit Requirements

1.2 WHAT IS THE MCP37X10-200 12-BIT SINGLE-CHANNEL EVALUATION BOARD (ADM00735)?

The MCP37X10-200 12-Bit Single-Channel Evaluation Board (ADM00735) is intended to demonstrate the performance of the MCP37X10-200 device family. This evaluation board is used together with:

- MCP37XXX High-Speed Pipeline ADC Data Capture Card (ADM00506)
- Pipeline ADC Utility Software

Refer to [Figure 1-1](#) for the system setup.

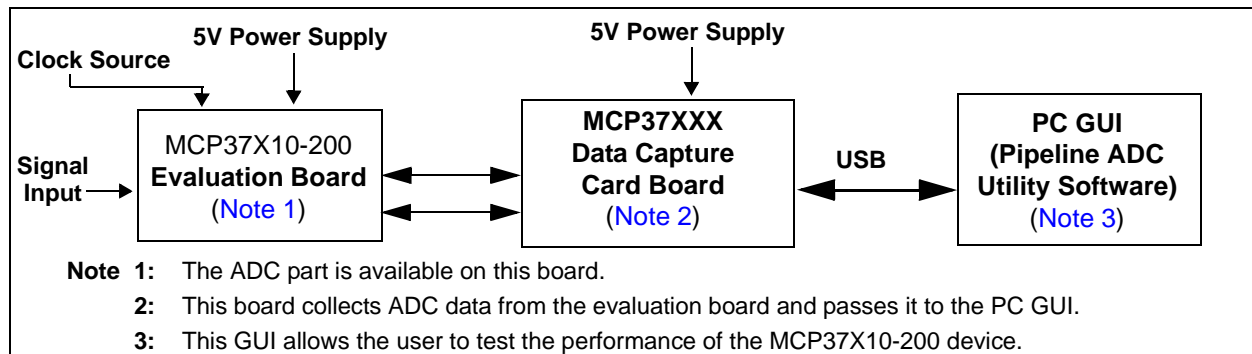
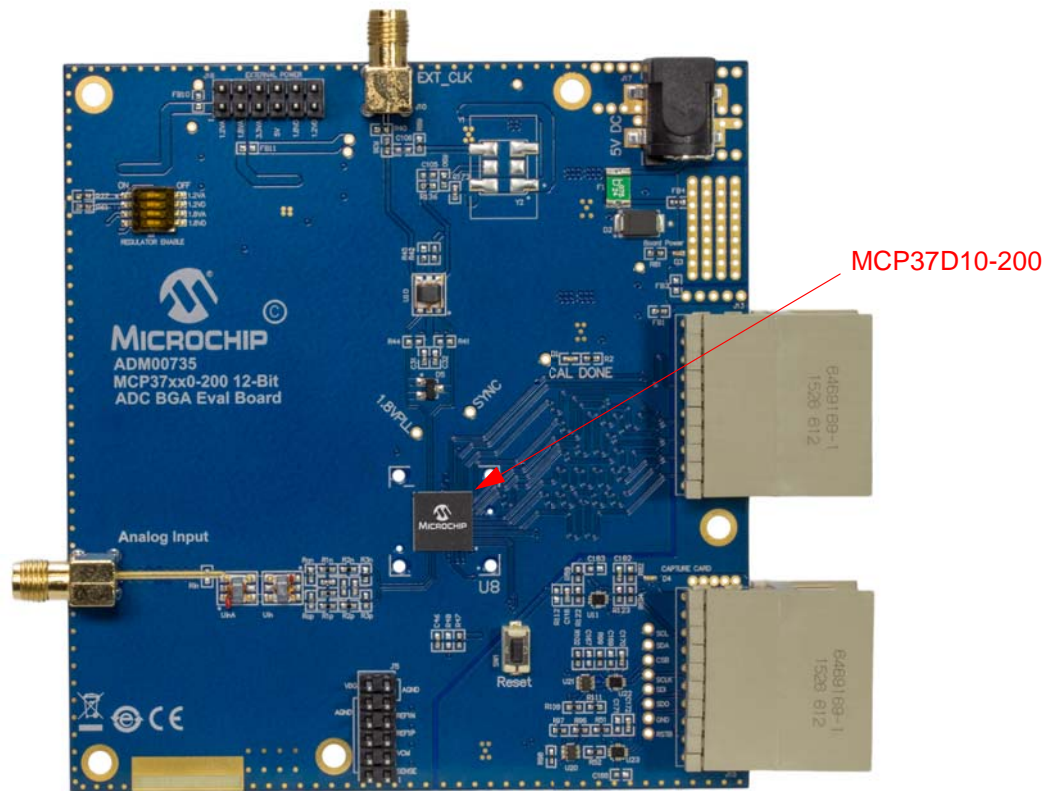

FIGURE 1-1: Evaluation Kit System Setup.

This evaluation board supports the following Microchip high-speed ADC device families:

- The MCP37210-200, which is Microchip Technology Inc.'s baseline single-channel 12-bit 200 Msps pipelined Analog-to-Digital Converter (ADC) device family, featuring a built-in high-order digital decimation filter, gain and offset adjustment, and a noise-shaping requantizer, which improves SNR within a specified frequency band.
- The MCP37D10-200 device family, which features digital down-conversion, in addition to the features offered by the baseline device family.

The MCP37X10-200 12-Bit Single-Channel Evaluation Board (ADM00735) comes with the MCP37D10-200 device on board. All conditions and features can be evaluated using this device. Refer to [Figure 1-3](#) for close-up photos of the evaluation board.



(a) Top View

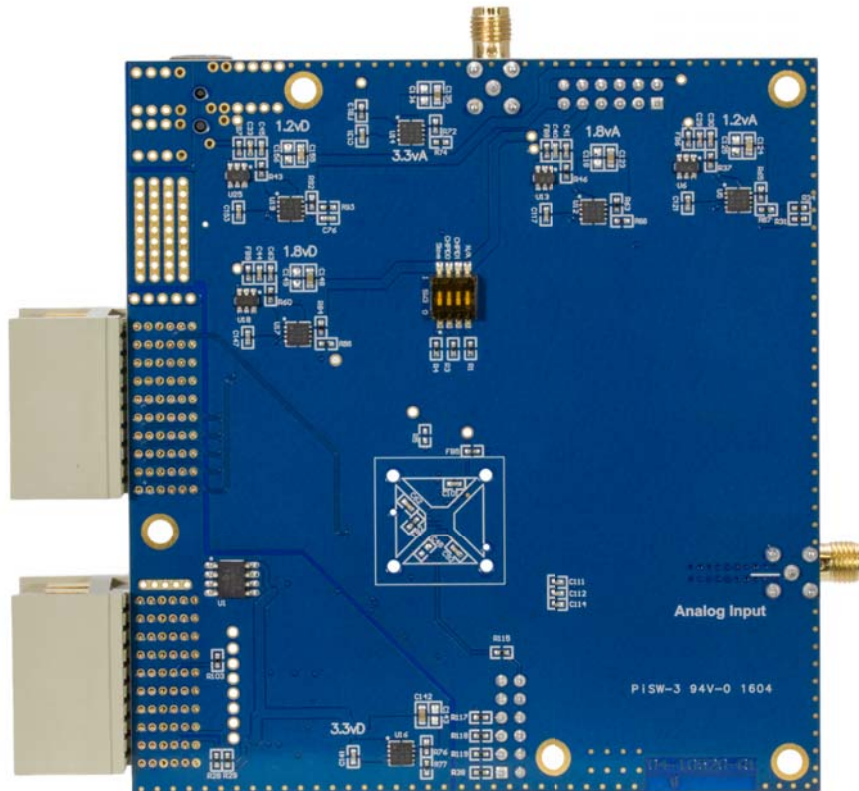

(b) Bottom View

FIGURE 1-2: MCP37X10-200 12-Bit 200 Mps ADC BGA Evaluation Board (ADM00735).

1.3 WHAT IS THE MCP37XXX HIGH-SPEED PIPELINE ADC DATA CAPTURE CARD (ADM00506)?

The MCP37XXX High-Speed Pipeline ADC Data Capture Card (ADM00506) is an FPGA-based memory buffer for the digital data received from the Analog-to-Digital Converter (ADC) evaluation board. [Figure 1-1](#) shows the connection of the data capture card directly between the evaluation board and the PC GUI.

The data capture card connects to the PC through a USB cable, providing the user with two functionalities:

- The ability to send user commands directly to the device from the PC GUI.
- The ability to collect data from the evaluation board and send it to the PC GUI.

Refer to [Figure 1-3](#) for close-up photos of the data capture card.

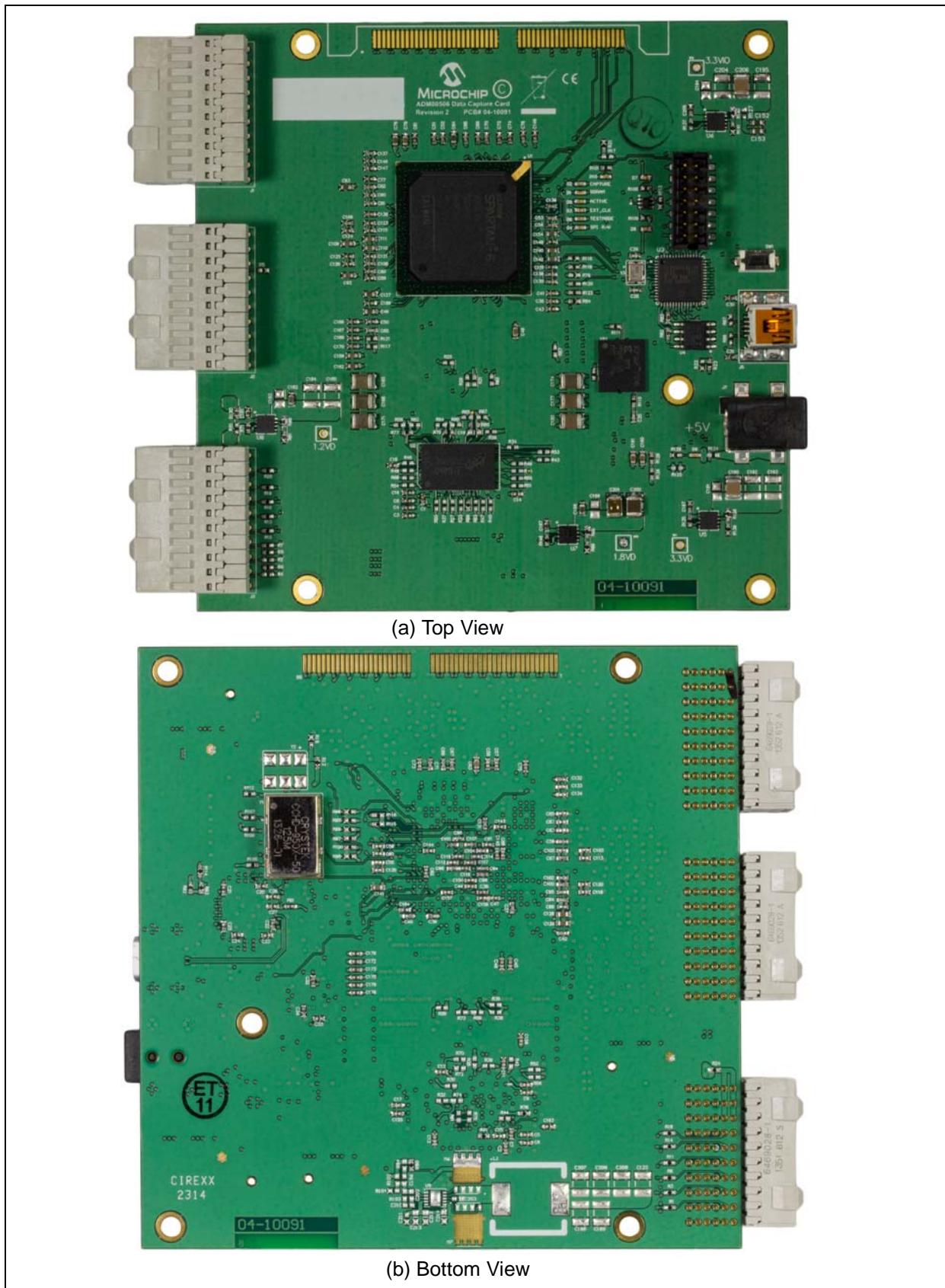

FIGURE 1-3: MCP37XXX High-Speed Pipeline ADC Data Capture Card (ADM00506).

1.4 WHAT IS THE PIPELINE ADC UTILITY SOFTWARE?

The Pipeline ADC Utility software is the graphical user interface (GUI) used to communicate with and to configure the operating parameters of the device. The software communicates with the part through the data capture card via a USB cable, allowing the user to program the internal ADC registers. When the user interacts with the software (for example, by updating the registers), the user's commands are passed to the MCP37D10-200 device via the data capture card. Once the commands are executed by the evaluation board, the software receives the requested data from the data capture card. The software will then analyze the data, perform a FFT or other analysis, and display the results. Refer to [Figure 1-1](#) for a diagram of the system setup. [Figure 1-4](#) shows a screen shot of the graphical interface.

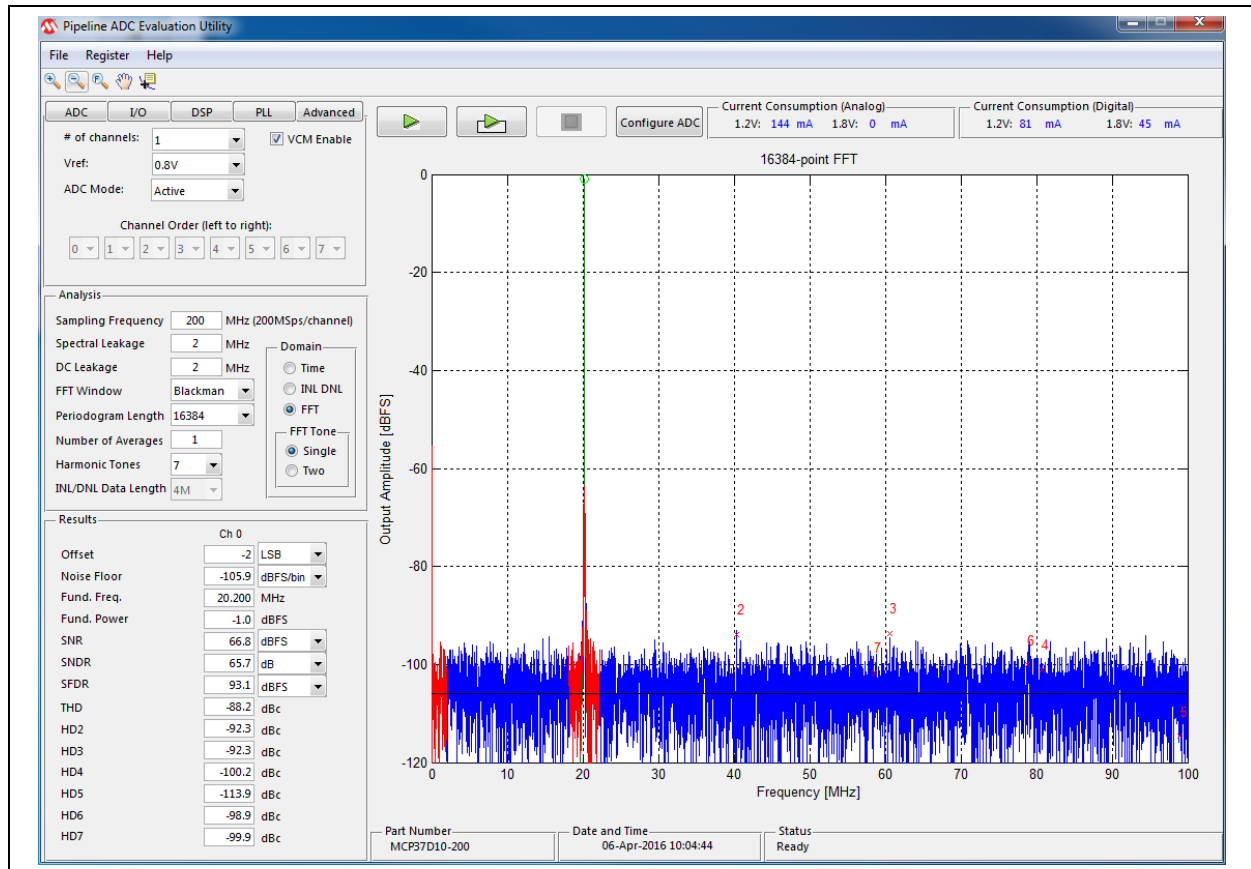

FIGURE 1-4: Pipeline ADC Utility Software Displaying a Typical FFT Waveform.

The Pipeline ADC Utility software is available for download on Microchip's website. For instructions on using the GUI, refer to the software's supporting documentation included with the installation file, as well as within the application Help menu.

1.5 MCP37X10-200 12-BIT SINGLE-CHANNEL EVALUATION KIT REQUIREMENTS

The evaluation kit requires the following:

- MCP37X10-200 12-Bit Single-Channel Evaluation Board (ADM00735)
- MCP37XXX High-Speed Pipeline ADC Data Capture Card (ADM00506)
 - Sold separately
- Two 5V Power Supplies
 - Included with the evaluation board and data capture card
- USB-A to USB Mini-B Cable
 - Included with the data capture card
- External Clock Source or Crystal Oscillator
 - Supplied by the user
- External Signal Input
 - Supplied by the user
- Pipeline ADC Utility Software
 - Available on the Microchip website

Chapter 2. Installation and Operation

2.1 MCP37X10-200 12-BIT SINGLE-CHANNEL EVALUATION KIT FEATURES

This MCP37X10-200 12-Bit Single-Channel Evaluation Kit is a fully assembled, programmed and tested solution (with the exception of a clock source) to evaluate and demonstrate the MCP37X10-200 operating performance.

The evaluation kit has the following features:

- Programmable Full-Scale Analog Input Range
- Dynamic Performance Monitoring
- Evaluation of Performance Metrics, such as: SNR, SFDR, INL, DNL, etc.
- User-Programmable Registers
- Real-Time Monitoring of Power Consumption
- Digital Post Processing Options: Decimation Filter, Digital Down-Conversion, Noise-Shaping Requantizer, etc.
- Ability to Save and Load Software Configurations
- Ability to Save and Load Raw Data for User Post-Processing

The evaluation kit features a sample rate of up to 200 Msps. For information about the device features, refer to the **MCP37X10-200 Data Sheet – “200 Msps, 12-Bit Low-Power Single-Channel ADC” (DS20005395)**.

2.2 GETTING STARTED

2.2.1 Configuration Requirements

To power-up and run the evaluation kit, the following are required:

- Pipeline ADC Utility Software
- MCP37X10-200 12-Bit Single-Channel Evaluation Board (ADM00735)
- MCP37XXX High-Speed Pipeline ADC Data Capture Card (ADM00506)
- Two 5V Power Supplies
- A USB-A to USB Mini-B Cable
- External Clock Source or Crystal Oscillator (see [Section 2.2.4.1 “Optimizing the Clock Connection”](#))
- External Signal Input (see [Section 2.2.4.2 “Optimizing the Analog Input Connection”](#))

2.2.2 Power Input Connection

This evaluation kit comes with two switching power supplies (Mean Well: GS06U-1P1J): one for each of the boards. These power supplies are able to provide a 5V, 1A maximum output. They can be connected to an AC wall outlet rated between 90V AC and 264V AC, at a frequency of 47 Hz to 63 Hz. The other end of the power supply is a 2.1 mm barrel plug that connects to both the evaluation board and the data capture card (see [Figure 2-1](#)). If the user chooses to connect a different external power supply, a minimum output of 750 mA is required.

The evaluation board's power supplies can also be supplied by external voltages directly to the power domains. This can be done by disabling the desired regulator using the dip switch SW2 - Regulator Enable on the silkscreen. Then, a DC voltage can be driven directly into the appropriate pin of header J16. Note that the even pins of the J16 header are GND.

The power domains on the evaluation board may be merged, if needed. Specifically, the 1.2VA and 1.2VD power domains may be merged by populating a ferrite bead on FB10. Similarly, the 1.8VA and 1.8VD power domains may be merged by populating a ferrite bead on FB11. In both cases, the digital regulators should be disabled using the appropriate switches.

WARNING

Avoid connecting a power supply with a voltage greater than 5V. Doing so can damage the voltage regulators, requiring them to be replaced.

2.2.3 Evaluation Kit Set-Up

1. Connect the evaluation board and the data capture card as shown in [Figure 2-1](#).
2. Power up both boards using the supplied 5V Power Supplies.
3. Ensure that a clock input is connected or that a crystal oscillator is installed correctly. Follow instructions in section [Section 2.2.4.1 "Optimizing the Clock Connection"](#).

1: Note: If this is done correctly, the CAL DONE LED will be ON. Otherwise, the user should check the clock input or crystal oscillator for issues.

4. Connect the data capture card to a computer using the provided USB cable.
5. Press the Reset button on both boards.
6. Run the Pipeline ADC Utility Software.

For help with troubleshooting the boards and operating the GUI, please refer to the software's supporting documentation.

WARNING

Avoid applying an input signal while the board is powered off. This may damage the input baluns! If a high second harmonic is seen, it is likely that these baluns need to be replaced.

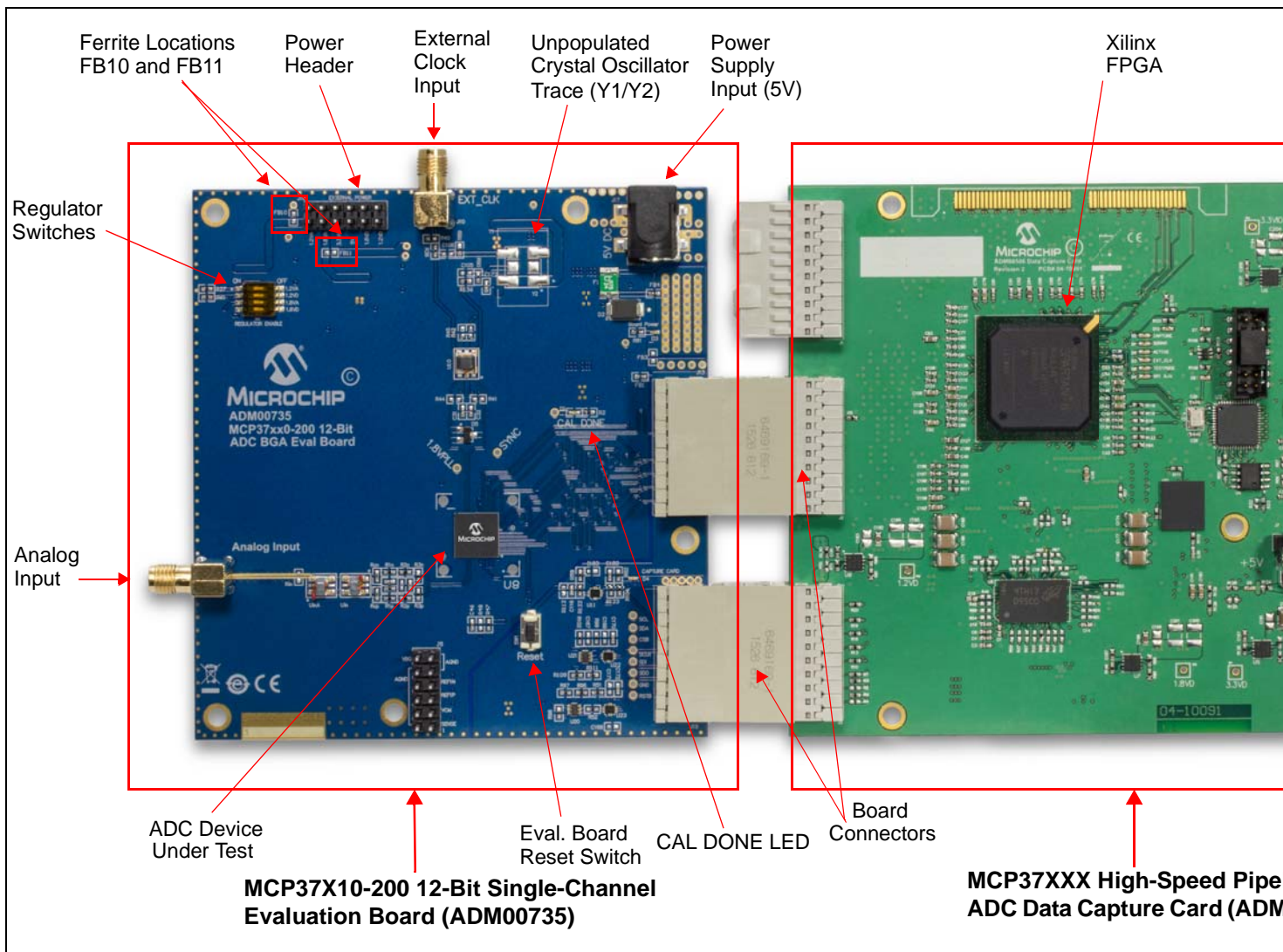

FIGURE 2-1: Evaluation Kit - The evaluation board connected to the data capture card.

2.2.4 Input/Output Optimization

2.2.4.1 OPTIMIZING THE CLOCK CONNECTION

The evaluation board does not come with a clock source for the device. The user must provide a clock source in order to run this evaluation board. The user has the following options:

- Using Microchip's 200 MHz Clock Source Evaluation Boards:
 - Microchip's ADM00725 or ADM00791 evaluation boards may be connected to the external clock SMA input (See [Figure 2-1](#)). These boards were developed as an optimized clock source for Microchip's High-Speed ADCs. For more information, refer to the board web page.
- Using a signal generator:
 - A clean and low-jitter clock signal can be connected to the external clock SMA input. For the signal generation, Rohde & Schwarz[®] SMA100A or Agilent Technologies HP8644B signal generators can be used. To ensure that a clean and low-jitter clock signal is provided, the user should interpose a band-pass filter to reduce the harmonics coming from the signal source. A 200 MHz band-pass filter, such as KC4T-200M-10P-50-3A from TTE[®] Inc., is recommended. A high-jitter or unfiltered clock source will reduce achievable SNR at higher input frequencies.
- Using a Crystal Oscillator on the board:
 - An unpopulated footprint is available on the board where the user can place a crystal oscillator. For a single-ended clock, refer to the instructions in Example 1. For a differential clock, refer to the instructions in Example 2. The user may also choose to place another type of clock as well. Note that the component values given below are for example only and may vary depending on the exact clock source used.

Example 1

A clock oscillator with a single-ended output may be populated on Y2. The use of a Microchip oscillator is recommended, such as the MXT573ABC200M000 for a 200 MHz clock. In this case, proceed to make the following modifications:

1. Remove R36
2. Populate R89 with a 499 Ω resistor
3. Populate C106 with a 15 pF capacitor.

Example 2

A clock oscillator with a differential LVPECL output may be populated on Y2. The use of a Microchip oscillator is recommended, such as the MXT575ABA200M000 for a 200 MHz clock. In this case, proceed to make the following modifications:

1. Remove R36 and R136
2. Populate R89 and R90 with a 210 Ω resistor
3. Populate C105 and C106 with a 22 pF capacitor.

2.2.4.2 OPTIMIZING THE ANALOG INPUT CONNECTION

The best way to evaluate the MCP37X10-200 device is to use a clean analog input signal with as little noise as possible. The signal can be provided using a signal generator, such as Rohde & Schwarz SMA100A or Agilent Technologies HP8644B, and can be used along with a bandpass filter. The filter will help with filtering the harmonic tones of the fundamental, as well as with reducing the phase noise of the source. Two such filters that can be used are:

-
-
- KC4T-70M-15P-50-69A, TTE Inc.'s 70 MHz filter
 - KC4T-20M-15P-50-69A, TTE Inc.'s 20 MHz filter

Note: If one of the analog inputs appears to not work properly, exhibiting issues such as a high 2nd harmonic or substantially lower fundamental power, it is likely that the baluns on that input network are damaged. Replacing them should resolve these issues.

2.2.4.3 OUTPUT DATA CONFIGURATION

The MCP37X10-200 device is able to provide both LVDS and CMOS outputs. However, this evaluation kit is designed for LVDS outputs only. The user can modify various other output data properties using the GUI, with the exception of the LVDS/CMOS output mode.

NOTES:



MCP37X10-200 12-BIT SINGLE-CHANNEL EVALUATION KIT USER'S GUIDE

Appendix A. Schematics and Layouts

NOTICE TO CUSTOMERS

Refer to the board's [web page](#) for the complete Schematics and Layouts.

NOTES:



MCP37X10-200 12-BIT SINGLE-CHANNEL EVALUATION KIT USER'S GUIDE

Appendix B. Bill of Materials (BOM)

NOTICE TO CUSTOMERS

Refer to the board's [web page](#) for the complete Bill of Materials.



MICROCHIP

Worldwide Sales and Service

AMERICAS

Corporate Office
2355 West Chandler Blvd.
Chandler, AZ 85224-6199
Tel: 480-792-7200
Fax: 480-792-7277
Technical Support:
<http://www.microchip.com/support>
Web Address:
www.microchip.com

Atlanta
Duluth, GA
Tel: 678-957-9614
Fax: 678-957-1455

Austin, TX
Tel: 512-257-3370

Boston
Westborough, MA
Tel: 774-760-0087
Fax: 774-760-0088

Chicago
Itasca, IL
Tel: 630-285-0071
Fax: 630-285-0075

Cleveland
Independence, OH
Tel: 216-447-0464
Fax: 216-447-0643

Dallas
Addison, TX
Tel: 972-818-7423
Fax: 972-818-2924

Detroit
Novi, MI
Tel: 248-848-4000

Houston, TX
Tel: 281-894-5983

Indianapolis
Noblesville, IN
Tel: 317-773-8323
Fax: 317-773-5453

Los Angeles
Mission Viejo, CA
Tel: 949-462-9523
Fax: 949-462-9608

New York, NY
Tel: 631-435-6000

San Jose, CA
Tel: 408-735-9110

Canada - Toronto
Tel: 905-695-1980
Fax: 905-695-2078

ASIA/PACIFIC

Asia Pacific Office
Suites 3707-14, 37th Floor
Tower 6, The Gateway
Harbour City, Kowloon

Hong Kong
Tel: 852-2943-5100
Fax: 852-2401-3431

Australia - Sydney
Tel: 61-2-9868-6733
Fax: 61-2-9868-6755

China - Beijing
Tel: 86-10-8569-7000
Fax: 86-10-8528-2104

China - Chengdu
Tel: 86-28-8665-5511
Fax: 86-28-8665-7889

China - Chongqing
Tel: 86-23-8980-9588
Fax: 86-23-8980-9500

China - Dongguan
Tel: 86-769-8702-9880

China - Guangzhou
Tel: 86-20-8755-8029

China - Hangzhou
Tel: 86-571-8792-8115
Fax: 86-571-8792-8116

China - Hong Kong SAR
Tel: 852-2943-5100
Fax: 852-2401-3431

China - Nanjing
Tel: 86-25-8473-2460
Fax: 86-25-8473-2470

China - Qingdao
Tel: 86-532-8502-7355
Fax: 86-532-8502-7205

China - Shanghai
Tel: 86-21-5407-5533
Fax: 86-21-5407-5066

China - Shenyang
Tel: 86-24-2334-2829
Fax: 86-24-2334-2393

China - Shenzhen
Tel: 86-755-8864-2200
Fax: 86-755-8203-1760

China - Wuhan
Tel: 86-27-5980-5300
Fax: 86-27-5980-5118

China - Xian
Tel: 86-29-8833-7252
Fax: 86-29-8833-7256

ASIA/PACIFIC

China - Xiamen
Tel: 86-592-2388138
Fax: 86-592-2388130

China - Zhuhai
Tel: 86-756-3210040
Fax: 86-756-3210049

India - Bangalore
Tel: 91-80-3090-4444
Fax: 91-80-3090-4123

India - New Delhi
Tel: 91-11-4160-8631
Fax: 91-11-4160-8632

India - Pune
Tel: 91-20-3019-1500

Japan - Osaka
Tel: 81-6-6152-7160
Fax: 81-6-6152-9310

Japan - Tokyo
Tel: 81-3-6880-3770
Fax: 81-3-6880-3771

Korea - Daegu
Tel: 82-53-744-4301
Fax: 82-53-744-4302

Korea - Seoul
Tel: 82-2-554-7200
Fax: 82-2-558-5932 or
82-2-558-5934

Malaysia - Kuala Lumpur
Tel: 60-3-6201-9857
Fax: 60-3-6201-9859

Malaysia - Penang
Tel: 60-4-227-8870
Fax: 60-4-227-4068

Philippines - Manila
Tel: 63-2-634-9065
Fax: 63-2-634-9069

Singapore
Tel: 65-6334-8870
Fax: 65-6334-8850

Taiwan - Hsin Chu
Tel: 886-3-5778-366
Fax: 886-3-5770-955

Taiwan - Kaohsiung
Tel: 886-7-213-7828

Taiwan - Taipei
Tel: 886-2-2508-8600
Fax: 886-2-2508-0102

Thailand - Bangkok
Tel: 66-2-694-1351
Fax: 66-2-694-1350

EUROPE

Austria - Wels
Tel: 43-7242-2244-39
Fax: 43-7242-2244-393

Denmark - Copenhagen
Tel: 45-4450-2828
Fax: 45-4485-2829

France - Paris
Tel: 33-1-69-53-63-20
Fax: 33-1-69-30-90-79

Germany - Dusseldorf
Tel: 49-2129-3766400

Germany - Karlsruhe
Tel: 49-721-625370

Germany - Munich
Tel: 49-89-627-144-0
Fax: 49-89-627-144-44

Italy - Milan
Tel: 39-0331-742611
Fax: 39-0331-466781

Italy - Venice
Tel: 39-049-7625286

Netherlands - Drunen
Tel: 31-416-690399
Fax: 31-416-690340

Poland - Warsaw
Tel: 48-22-3325737

Spain - Madrid
Tel: 34-91-708-08-90
Fax: 34-91-708-08-91

Sweden - Stockholm
Tel: 46-8-5090-4654

UK - Wokingham
Tel: 44-118-921-5800
Fax: 44-118-921-5820

06/23/16

X-ON Electronics

Largest Supplier of Electrical and Electronic Components

Click to view similar products for [Data Conversion IC Development Tools](#) category:

Click to view products by [Microchip](#) manufacturer:

Other Similar products are found below :

[EVAL-AD7265EDZ](#) [EVAL-AD7719EBZ](#) [EVAL-AD7767-1EDZ](#) [EVAL-AD7995EBZ](#) [AD9211-200EBZ](#) [AD9251-20EBZ](#) [AD9251-65EBZ](#)
[AD9613-170EBZ](#) [AD9629-20EBZ](#) [AD9716-DPG2-EBZ](#) [AD9737A-EBZ](#) [AD9993-EBZ](#) [DAC8555EVM](#) [EVAL-AD5061EBZ](#) [EVAL-](#)
[AD5062EBZ](#) [EVAL-AD5443-DBRDZ](#) [EVAL-AD5570SDZ](#) [EVAL-AD7992EBZ](#) [EVAL-AD7994EBZ](#) [AD9119-MIX-EBZ](#) [AD9233-125EBZ](#)
[AD9629-80EBZ](#) [AD9650-80EBZ](#) [AD9767-EBZ](#) [DAC8531EVM](#) [LM96080EB/NOPB](#) [EVAL-AD5445SDZ](#) [EVAL-AD5660EBZ](#) [EVAL-](#)
[AD7685SDZ](#) [EVAL-AD7687SDZ](#) [MAX5318PMB#](#) [MAX1246EVL11-QSOP](#) [MAX117EVKIT-DIP](#) [DC2365A-C](#) [DC2795A-B](#) [DC2795A-A](#)
[DAC088S085EB/NOPB](#) [SIM8909-EVB-KIT](#) [82635ASRCDVKHV 961443](#) [DC1466B-B](#) [EVAL-AD5413SDZ](#) [ADC12D1600RB/NOPB](#) [1083](#)
[RFPDK FOR CMT2X5X](#) [TS7003DB](#) [TSC2014EVM-PDK](#) [MOD-USB3G](#) [KDC5514EVALZ](#) [650201392G](#) [ISL28005FH-100EVAL1Z](#)