

## ULTRAFAST SOFT RECOVERY RECTIFIER DIODE

### PRODUCT APPLICATIONS

- Anti-Parallel Diode
  - Switchmode Power Supply
  - Inverters
- Free Wheeling Diode
  - Motor Controllers
  - Converters
  - Inverters
- Snubber Diode
- PFC

### PRODUCT FEATURES

- Ultrafast Recovery Times
- Soft Recovery Characteristics
- Popular TO-247 Package or Surface Mount D<sup>3</sup>PAK Package
- Low Forward Voltage
- Low Leakage Current
- Avalanche Energy Rated

### PRODUCT BENEFITS

- Low Losses
- Low Noise Switching
- Cooler Operation
- Higher Reliability Systems
- Increased System Power Density

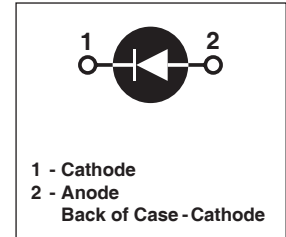
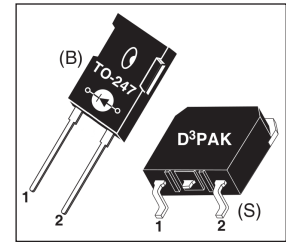

### MAXIMUM RATINGS

 All Ratings:  $T_C = 25^\circ\text{C}$  unless otherwise specified.

Symbol	Characteristic / Test Conditions	APT15DQ60(B/S)G	UNIT
$V_R$	Maximum D.C. Reverse Voltage	600	Volts
$V_{RRM}$	Maximum Peak Repetitive Reverse Voltage		
$V_{RWM}$	Maximum Working Peak Reverse Voltage		
$I_{F(AV)}$	Maximum Average Forward Current ( $T_C = 129^\circ\text{C}$ , Duty Cycle = 0.5)	15	Amps
$I_{F(RMS)}$	RMS Forward Current (Square wave, 50% duty)	30	
$I_{FSM}$	Non-Repetitive Forward Surge Current ( $T_J = 45^\circ\text{C}$ , 8.3ms)	110	
$E_{AVL}$	Avalanche Energy (1A, 40mH)	20	mJ
$T_J, T_{STG}$	Operating and Storage Temperature Range	-55 to 175	°C
$T_L$	Lead Temperature for 10 Sec.	300	

### STATIC ELECTRICAL CHARACTERISTICS

Symbol	Characteristic / Test Conditions	MIN	TYP	MAX	UNIT
$V_F$	Forward Voltage	$I_F = 15\text{A}$	2.0	2.4	Volts
		$I_F = 30\text{A}$	2.5		
		$I_F = 15\text{A}, T_J = 125^\circ\text{C}$	1.56		
$I_{RM}$	Maximum Reverse Leakage Current	$V_R = 600\text{V}$		25	$\mu\text{A}$
		$V_R = 600\text{V}, T_J = 125^\circ\text{C}$		500	
$C_T$	Junction Capacitance, $V_R = 200\text{V}$		25		pF

## DYNAMIC CHARACTERISTICS

APT15DQ60(B/S)G

Symbol	Characteristic	Test Conditions	MIN	TYP	MAX	UNIT
$t_{rr}$	Reverse Recovery Time	$I_F = 1A, di_F/dt = -100A/\mu s, V_R = 30V, T_J = 25^\circ C$	-	15		ns
$t_{rr}$	Reverse Recovery Time	$I_F = 15A, di_F/dt = -200A/\mu s, V_R = 400V, T_C = 25^\circ C$	-	19		
$Q_{rr}$	Reverse Recovery Charge		-	21		
$I_{RRM}$	Maximum Reverse Recovery Current		-	2	-	Amps
$t_{rr}$	Reverse Recovery Time	$I_F = 15A, di_F/dt = -200A/\mu s, V_R = 400V, T_C = 125^\circ C$	-	105		ns
$Q_{rr}$	Reverse Recovery Charge		-	250		nC
$I_{RRM}$	Maximum Reverse Recovery Current		-	5	-	Amps
$t_{rr}$	Reverse Recovery Time	$I_F = 15A, di_F/dt = -1000A/\mu s, V_R = 400V, T_C = 125^\circ C$	-	55		ns
$Q_{rr}$	Reverse Recovery Charge		-	420		nC
$I_{RRM}$	Maximum Reverse Recovery Current		-	15		Amps

## THERMAL AND MECHANICAL CHARACTERISTICS

Symbol	Characteristic / Test Conditions	MIN	TYP	MAX	UNIT
$R_{\theta JC}$	Junction-to-Case Thermal Resistance			1.35	$^\circ C/W$
$W_T$	Package Weight		0.22		oz
			5.9		g
Torque	Maximum Mounting Torque			10	lb•in
				1.1	N•m

Microsemi reserves the right to change, without notice, the specifications and information contained herein.

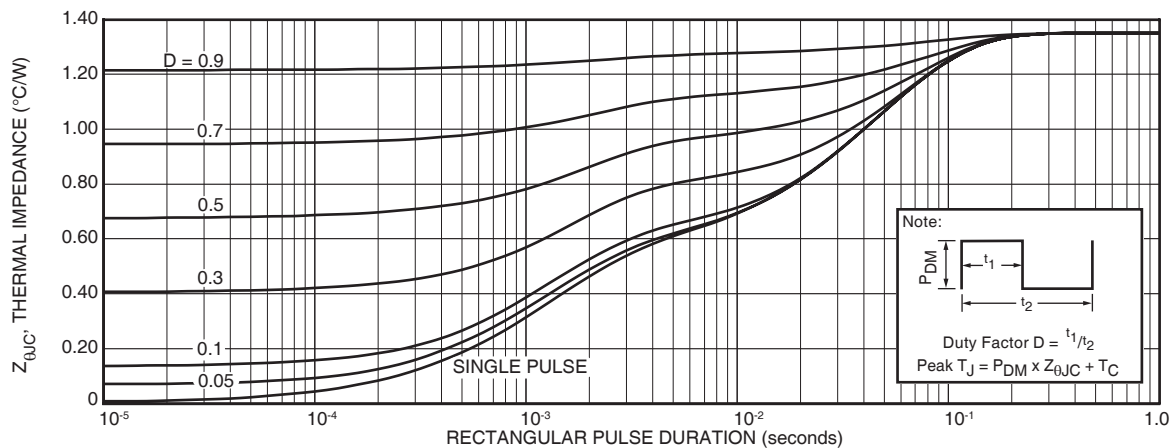

FIGURE 1a. MAXIMUM EFFECTIVE TRANSIENT THERMAL IMPEDANCE, JUNCTION-TO-CASE vs. PULSE DURATION

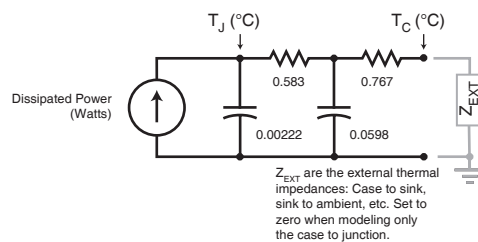

FIGURE 1b, TRANSIENT THERMAL IMPEDANCE MODEL

# TYPICAL PERFORMANCE CURVES

APT15DQ60(B/S)G

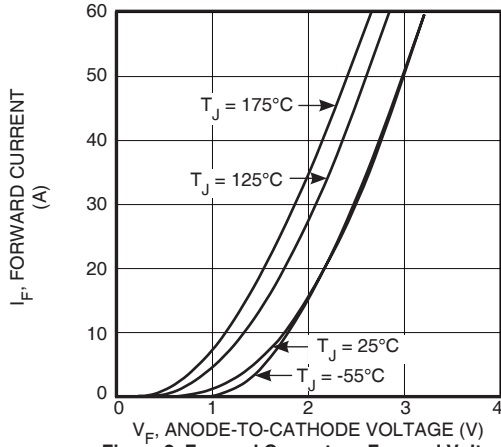

Figure 2. Forward Current vs. Forward Voltage

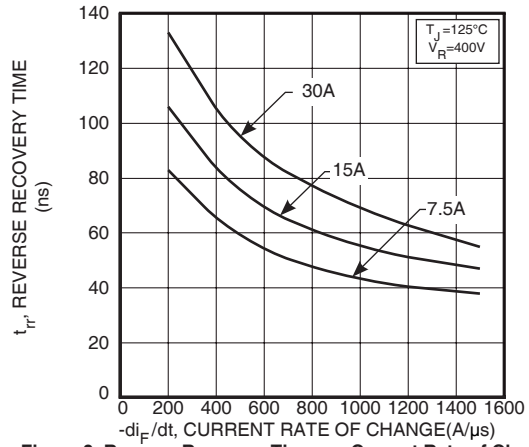

Figure 3. Reverse Recovery Time vs. Current Rate of Change

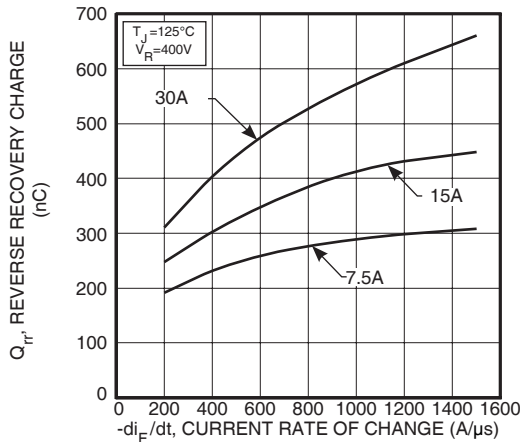

Figure 4. Reverse Recovery Charge vs. Current Rate of Change

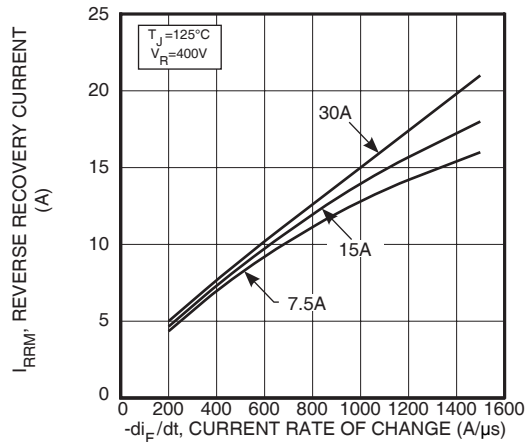

Figure 5. Reverse Recovery Current vs. Current Rate of Change

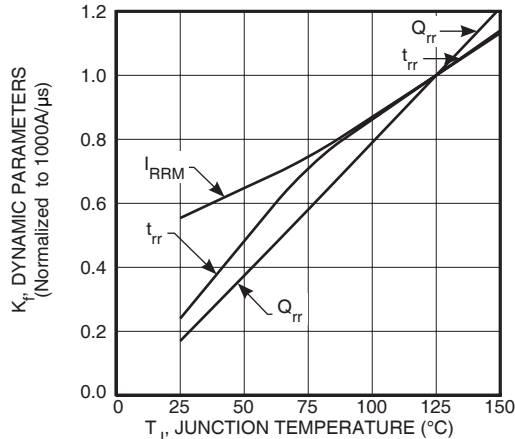

Figure 6. Dynamic Parameters vs. Junction Temperature

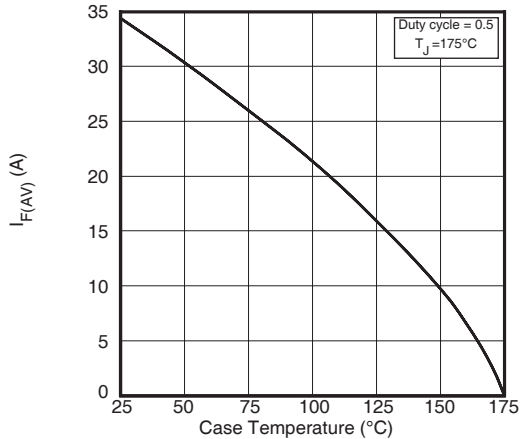

Figure 7. Maximum Average Forward Current vs. Case Temperature

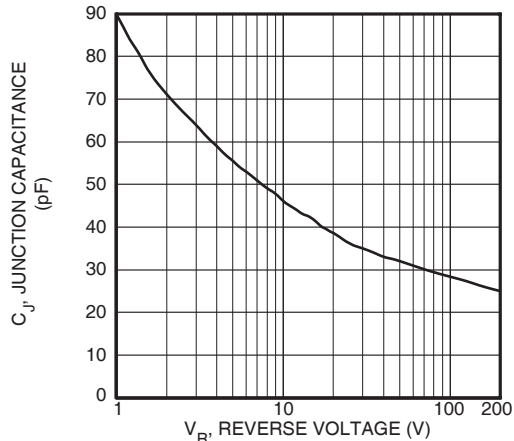

Figure 8. Junction Capacitance vs. Reverse Voltage

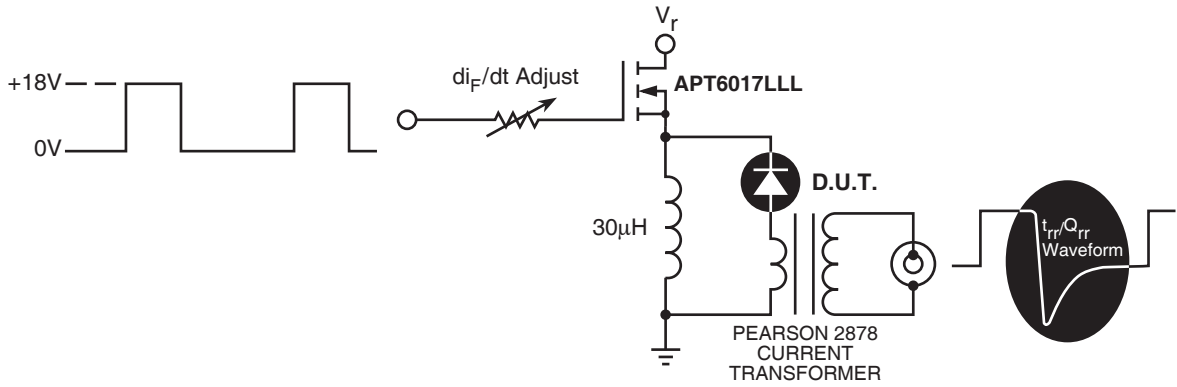

Figure 9. Diode Test Circuit

- 1  $I_F$  - Forward Conduction Current
- 2  $di_F/dt$  - Rate of Diode Current Change Through Zero Crossing.
- 3  $I_{RRM}$  - Maximum Reverse Recovery Current.
- 4  $t_{rr}$  - Reverse Recovery Time, measured from zero crossing where diode current goes from positive to negative, to the point at which the straight line through  $I_{RRM}$  and  $0.25 \cdot I_{RRM}$  passes through zero.
- 5  $Q_{rr}$  - Area Under the Curve Defined by  $I_{RRM}$  and  $t_{rr}$ .

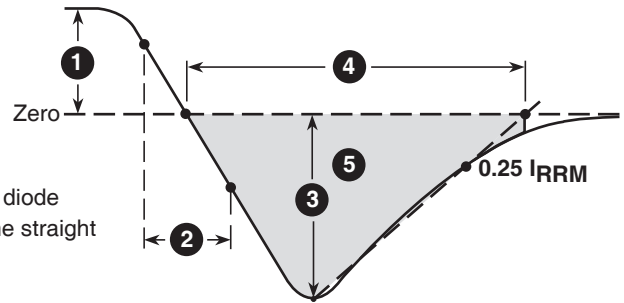
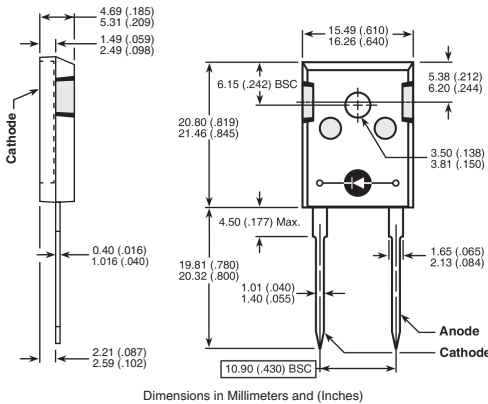
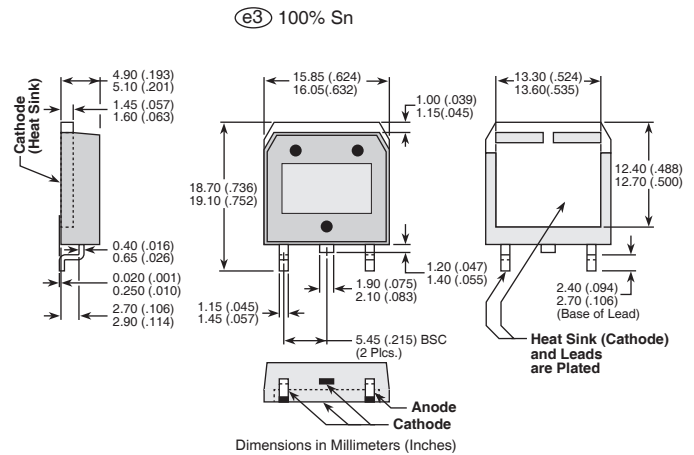

Figure 10, Diode Reverse Recovery Waveform and Definitions

TO-247 Package Outline



D<sup>3</sup>PAK Package Outline



**Microsemi Headquarters**  
 One Enterprise, Aliso Viejo,  
 CA 92656 USA  
 Within the USA: +1 (800) 713-4113  
 Outside the USA: +1 (949) 380-6100  
 Sales: +1 (949) 380-6136  
 Fax: +1 (949) 215-4996  
 Email: sales.support@microsemi.com  
 www.microsemi.com

© 2019 Microsemi. All rights reserved. Microsemi and the Microsemi logo are trademarks of Microsemi Corporation. All other trademarks and service marks are the property of their respective owners.

Microsemi makes no warranty, representation, or guarantee regarding the information contained herein or the suitability of its products and services for any particular purpose, nor does Microsemi assume any liability whatsoever arising out of the application or use of any product or circuit. The products sold hereunder and any other products sold by Microsemi have been subject to limited testing and should not be used in conjunction with mission-critical equipment or applications. Any performance specifications are believed to be reliable but are not verified, and Buyer must conduct and complete all performance and other testing of the products, alone and together with, or installed in, any end-products. Buyer shall not rely on any data and performance specifications or parameters provided by Microsemi. It is the Buyer's responsibility to independently determine suitability of any products and to test and verify the same. The information provided by Microsemi hereunder is provided "as is, where is" and with all faults, and the entire risk associated with such information is entirely with the Buyer. Microsemi does not grant, explicitly or implicitly, to any party any patent rights, licenses, or any other IP rights, whether with regard to such information itself or anything described by such information. Information provided in this document is proprietary to Microsemi, and Microsemi reserves the right to make any changes to the information in this document or to any products and services at any time without notice.

Microsemi, a wholly owned subsidiary of Microchip Technology Inc. (Nasdaq: MCHP), offers a comprehensive portfolio of semiconductor and system solutions for aerospace & defense, communications, data center and industrial markets. Products include high-performance and radiation-hardened analog mixed-signal integrated circuits, FPGAs, SoCs and ASICs; power management products; timing and synchronization devices and precise time solutions, setting the world's standard for time; voice processing devices; RF solutions; discrete components; enterprise storage and communication solutions; security technologies and scalable anti-tamper products; Ethernet solutions; Power-over-Ethernet ICs and midspans; as well as custom design capabilities and services. Microsemi is headquartered in Aliso Viejo, California, and has approximately 4,800 employees globally. Learn more at www.microsemi.com.

## X-ON Electronics

Largest Supplier of Electrical and Electronic Components

*Click to view similar products for [Rectifiers](#) category:*

*Click to view products by [Microchip](#) manufacturer:*

Other Similar products are found below :

[70HFR40](#) [RL252-TP](#) [150KR30A](#) [1N5397](#) [NTE5841](#) [NTE6038](#) [SCF5000](#) [1N4002G](#) [1N4005-TR](#) [JANS1N6640US](#) [481235F](#)  
[RRE02VS6SGTR](#) [067907F](#) [MS306](#) [70HF40](#) [T85HFL60S02](#) [US2JFL-TP](#) [A1N5404G-G](#) [ACGRA4007-HF](#) [ACGRB207-HF](#)  
[CLH03\(Te16L,Q\)](#) [ACGRC307-HF](#) [ACEFC304-HF](#) [NTE6356](#) [NTE6359](#) [NTE6002](#) [NTE6023](#) [NTE6039](#) [NTE6077](#) [85HFR60](#) [40HFR60](#)  
[70HF120](#) [85HFR80](#) [D126A45C](#) [SCF7500](#) [D251N08B](#) [SCHJ22.5K](#) [SM100](#) [SCPA2](#) [SCH10000](#) [SDHD5K](#) [VS-12FL100S10](#) [ACGRA4001-](#)  
[HF](#) [D1821SH45T PR](#) [D1251S45T](#) [NTE5990](#) [NTE6358](#) [NTE6162](#) [NTE5850](#) [SKN300/16](#)