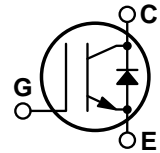
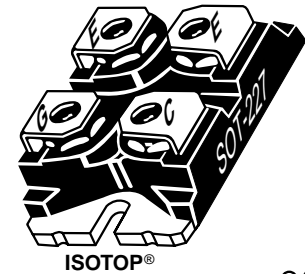

Fast IGBT

The Fast IGBT is a new generation of high voltage power IGBTs. Using Non-Punch Through Technology the Fast IGBT offers superior ruggedness, fast switching speed and low Collector-Emitter On voltage.

- Low Forward Voltage Drop
- Low Tail Current
- High Freq. Switching to 20KHz
- Ultra Low Leakage Current
- RBSOA and SCSOA Rated

MAXIMUM RATINGS

 All Ratings: $T_C = 25^\circ\text{C}$ unless otherwise specified.

Symbol	Parameter	APT50GF60B2RD/LRD	UNIT
V_{CES}	Collector-Emitter Voltage	1200	Volts
V_{CGR}	Collector-Gate Voltage ($R_{GE} = 20K\Omega$)	1200	
V_{GE}	Gate Emitter Voltage	± 20	
I_{C1}	Continuous Collector Current ³ @ $T_C = 25^\circ\text{C}$	75	Amps
I_{C2}	Continuous Collector Current @ $T_C = 60^\circ\text{C}$	50	
I_{CM}	Pulsed Collector Current ^① @ $T_C = 25^\circ\text{C}$	150	
I_{LM}	RBSOA Clamped Inductive Load Current @ $R_G = 11\Omega$ $T_C = 90^\circ\text{C}$	100	
P_D	Total Power Dissipation	460	Watts
T_J, T_{STG}	Operating and Storage Junction Temperature Range	-55 to 150	$^\circ\text{C}$
T_L	Max. Lead Temp. for Soldering: 0.063" from Case for 10 Sec.	300	

STATIC ELECTRICAL CHARACTERISTICS

Symbol	Characteristic / Test Conditions	MIN	TYP	MAX	UNIT
$V_{GE(TH)}$	Gate Threshold Voltage ($V_{CE} = V_{GE}, I_C = 700\mu\text{A}, T_j = 25^\circ\text{C}$)	4.5	5.5	6.5	Volts
$V_{CE(ON)}$	Collector-Emitter On Voltage ($V_{GE} = 15\text{V}, I_C = 50\text{A}, T_j = 25^\circ\text{C}$)		2.9	3.4	
	Collector-Emitter On Voltage ($V_{GE} = 15\text{V}, I_C = 50\text{A}, T_j = 125^\circ\text{C}$)		3.5	4.1	
I_{CES}	Collector Cut-off Current ($V_{CE} = V_{CES}, V_{GE} = 0\text{V}, T_j = 25^\circ\text{C}$)			0.75	mA
	Collector Cut-off Current ($V_{CE} = V_{CES}, V_{GE} = 0\text{V}, T_j = 125^\circ\text{C}$)			5.5	
I_{GES}	Gate-Emitter Leakage Current ($V_{GE} = \pm 20\text{V}, V_{CE} = 0\text{V}$)			± 100	nA

 **CAUTION:** These Devices are Sensitive to Electrostatic Discharge. Proper Handling Procedures Should Be Followed.

DYNAMIC CHARACTERISTICS

APT50GF120JRD

Symbol	Characteristic	Test Conditions	MIN	TYP	MAX	UNIT
C _{ies}	Input Capacitance	Capacitance V _{GE} = 0V V _{CE} = 25V f = 1 MHz		3450	4200	pF
C _{oes}	Output Capacitance			330	470	
C _{res}	Reverse Transfer Capacitance			230	350	
Q _g	Total Gate Charge ③	Gate Charge V _{GE} = 15V V _{CC} = 0.5V _{CES} I _C = I _{C2}		325	490	nC
Q _{ge}	Gate-Emitter Charge			35	40	
Q _{gc}	Gate-Collector ("Miller") Charge			195	300	
t _{d(on)}	Turn-on Delay Time	Resistive Switching (25°C) V _{GE} = 15V V _{CC} = 0.5V _{CES} I _C = I _{C2} R _G = 10Ω		47	94	ns
t _r	Rise Time			178	360	
t _{d(off)}	Turn-off Delay Time			320	480	
t _f	Fall Time			190	380	
t _{d(on)}	Turn-on Delay Time	Inductive Switching (150°C) V _{CLAMP(Peak)} = 0.66V _{CES} V _{GE} = 15V I _C = I _{C2} R _G = 10Ω T _J = +150°C		45	90	ns
t _r	Rise Time			102	210	
t _{d(off)}	Turn-off Delay Time			440	880	
t _f	Fall Time			102	210	
E _{on}	Turn-on Switching Energy	R _G = 10Ω T _J = +150°C		6.4	13	mJ
E _{off}	Turn-off Switching Energy			5.6	12	
E _{ts}	Total Switching Losses			12.0	25	
t _{d(on)}	Turn-on Delay Time	Inductive Switching (25°C) V _{CLAMP(Peak)} = 0.66V _{CES} V _{GE} = 15V I _C = I _{C2} R _G = 10Ω T _J = +25°C		46	100	ns
t _r	Rise Time			115	230	
t _{d(off)}	Turn-off Delay Time			390	790	
t _f	Fall Time			100	210	
E _{ts}	Total Switching Losses			10.8	22	mJ
g _{fe}	Forward Transconductance	V _{CE} = 20V, I _C = I _{C2}	8			S

THERMAL AND MECHANICAL CHARACTERISTICS

Symbol	Characteristic	MIN	TYP	MAX	UNIT
R _{θJC}	Junction to Case (IGBT)			0.32	°C/W
	Junction to Case (FRED)			0.66	
R _{θJA}	Junction to Ambient			40	
W _T	Package Weight		1.03		oz
			29.2		gm
Torque	Mounting Torque (Mounting = 8-32 or 4mm Machine and Terminals = 4mm Machine)			10	lb•in
				1.1	N•m

① Repetitive Rating: Pulse width limited by maximum junction temperature.

② I_C = I_{C2}, R_{GE} = 25Ω, L = 68μH, T_J = 25°C

③ See MIL-STD-750 Method 3471

APT Reserves the right to change, without notice, the specifications and information contained herein.

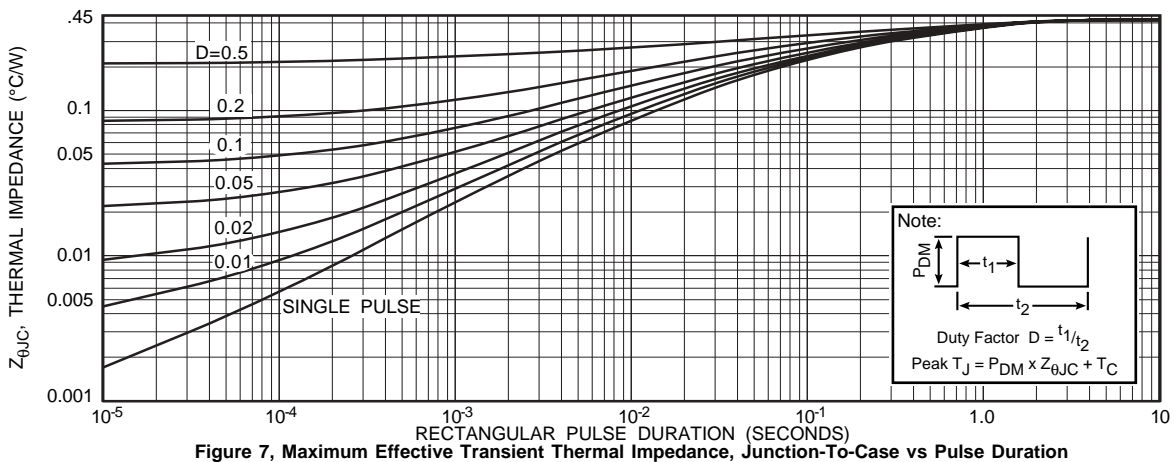
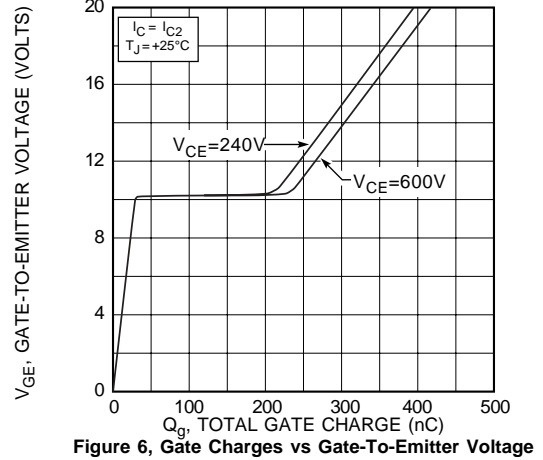
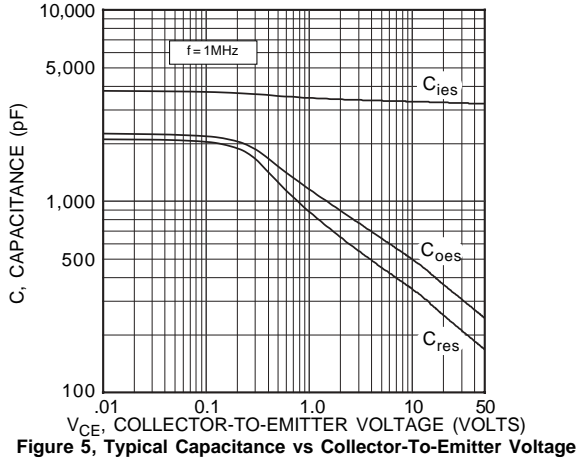
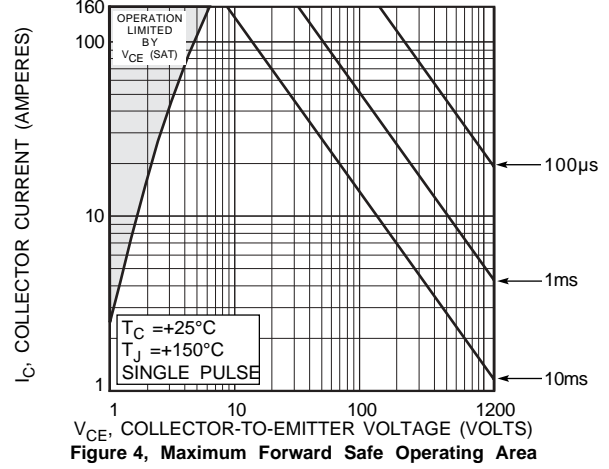
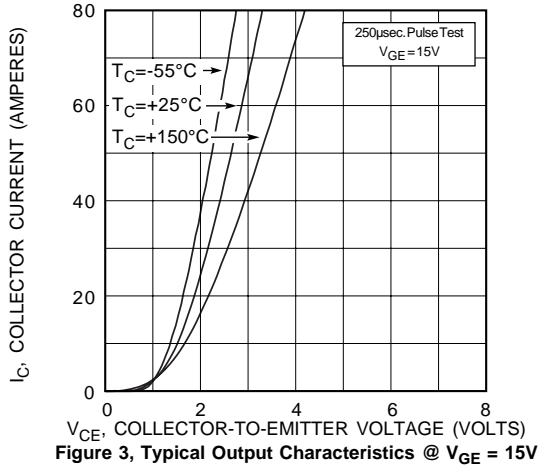
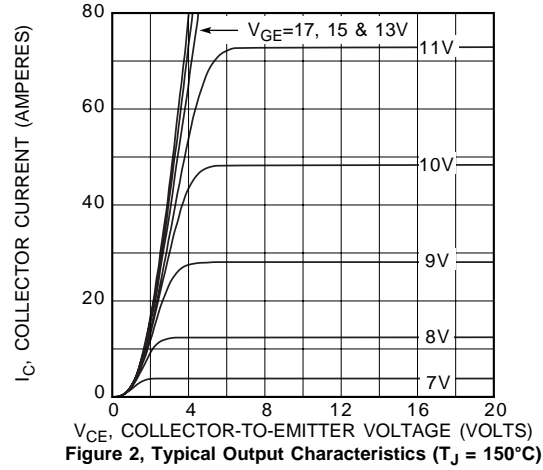
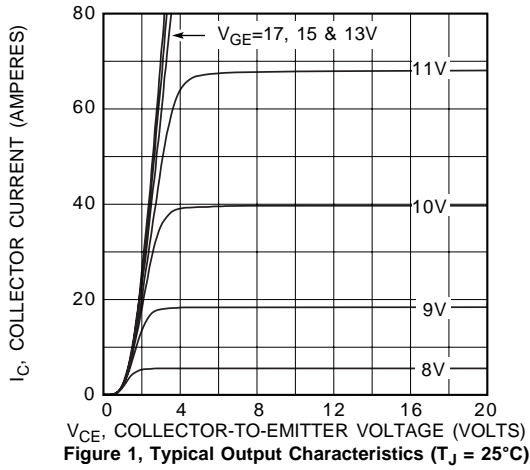

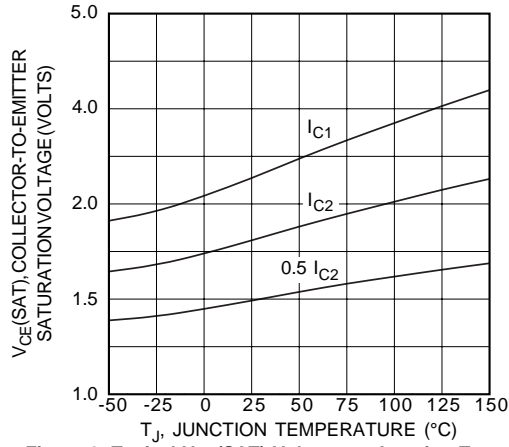

Figure 8, Typical $V_{CE(SAT)}$ Voltage vs Junction Temperature

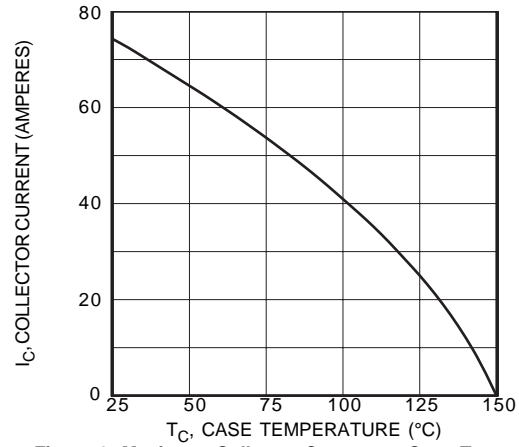

Figure 9, Maximum Collector Current vs Case Temperature

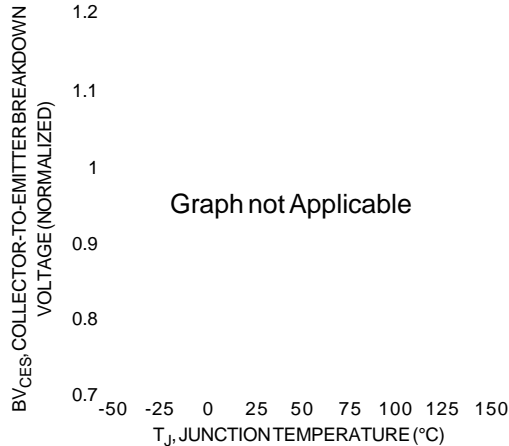

Figure 10, Breakdown Voltage vs Junction Temperature

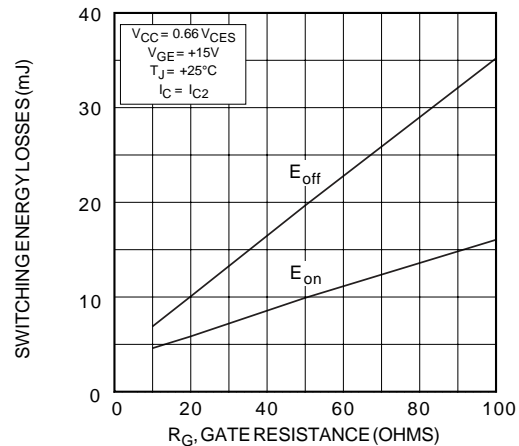

Figure 11, Typical Switching Energy Losses vs Gate Resistance

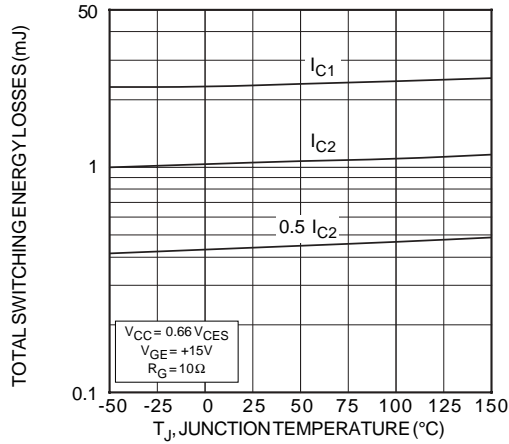

Figure 12, Typical Switching Energy Losses vs. Junction Temperature

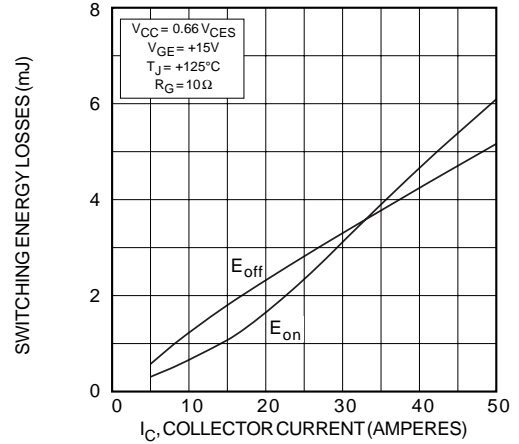

Figure 13, Typical Switching Energy Losses vs Collector Current

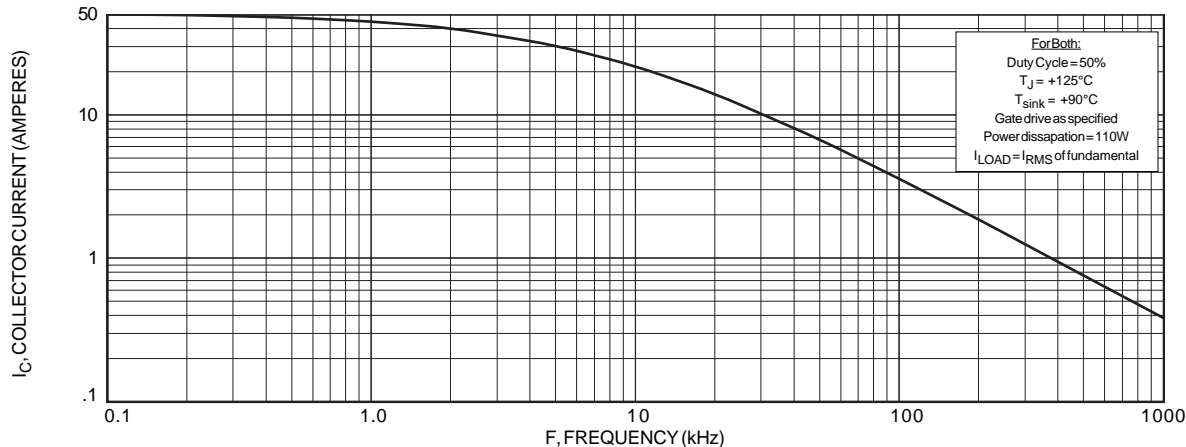

Figure 14, Typical Load Current vs Frequency

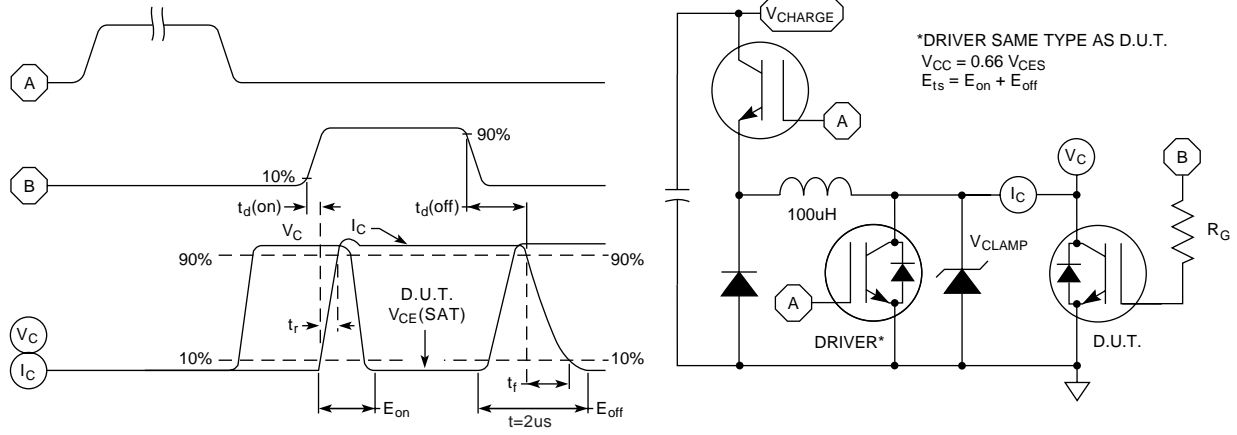

Figure 15, Switching Loss Test Circuit and Waveforms

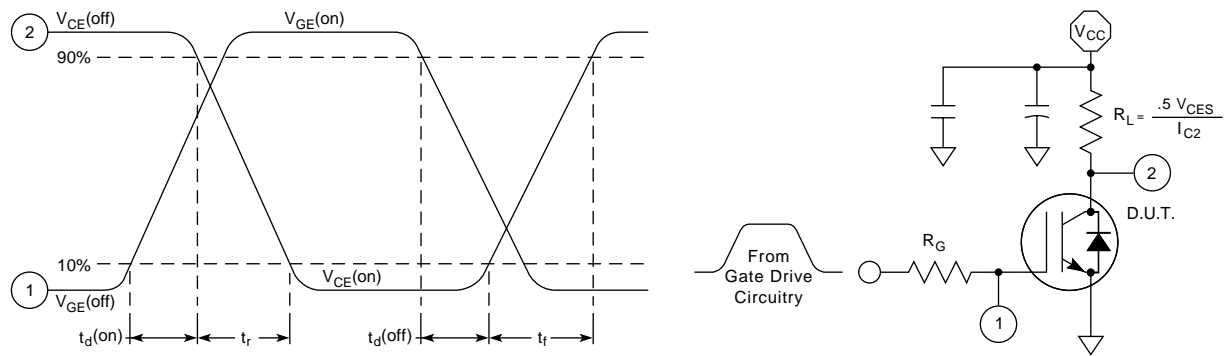

Figure 16, Resistive Switching Time Test Circuit and Waveforms

MAXIMUM RATINGS (FRED)

All Ratings: $T_C = 25^\circ C$ unless otherwise specified.

Symbol	Characteristic	APT50GF120JRD	UNIT
$I_{F_{AV}}$	Maximum Average Forward Current ($T_C = 100^\circ C$, Duty Cycle = 0.5)	60	Amps
$I_{F_{RMS}}$	RMS Forward Current	115	
$I_{F_{FSM}}$	Non-Repetive Forward Surge Current ($T_J = 45^\circ C$, 8.3 ms)	540	

STATIC ELECTRICAL CHARACTERISTICS (FRED)

Symbol	Characteristic / Test Conditions	MIN	TYP	MAX	UNIT
V_F	Maximum Forward Voltage	$I_F = 60A$		2.5	Volts
		$I_F = 120A$		2.7	
		$I_F = 60A, T_J = 150^\circ C$		2.0	

Symbol	Characteristic	MIN	TYP	MAX	UNIT
t_{rr1}	Reverse Recovery Time, $I_F = 1.0A, di_F/dt = -15A/\mu s, V_R = 30V, T_J = 25^\circ C$		70	85	ns
t_{rr2}	Reverse Recovery Time	$T_J = 25^\circ C$	70		
t_{rr3}	$I_F = 60A, di_F/dt = -480A/\mu s, V_R = 650V$	$T_J = 100^\circ C$	130		
t_{fr1}	Forward Recovery Time	$T_J = 25^\circ C$	170		
t_{fr2}	$I_F = 60A, di_F/dt = 480A/\mu s, V_R = 650V$	$T_J = 100^\circ C$	170		
I_{RRM1}	Reverse Recovery Current	$T_J = 25^\circ C$	18	30	
I_{RRM2}	$I_F = 60A, di_F/dt = -480A/\mu s, V_R = 650V$	$T_J = 100^\circ C$	29	40	
Q_{rr1}	Recovery Charge	$T_J = 25^\circ C$	630		nC
Q_{rr2}	$I_F = 60A, di_F/dt = -480A/\mu s, V_R = 650V$	$T_J = 100^\circ C$	1820		
V_{fr1}	Forward Recovery Voltage	$T_J = 25^\circ C$	12		Volts
V_{fr2}	$I_F = 60A, di_F/dt = 480A/\mu s, V_R = 650V$	$T_J = 100^\circ C$	12		
diM/dt	Rate of Fall of Recovery Current	$T_J = 25^\circ C$	900		A/ μs
	$I_F = 60A, di_F/dt = -480A/\mu s, V_R = 650V$	$T_J = 100^\circ C$	600		

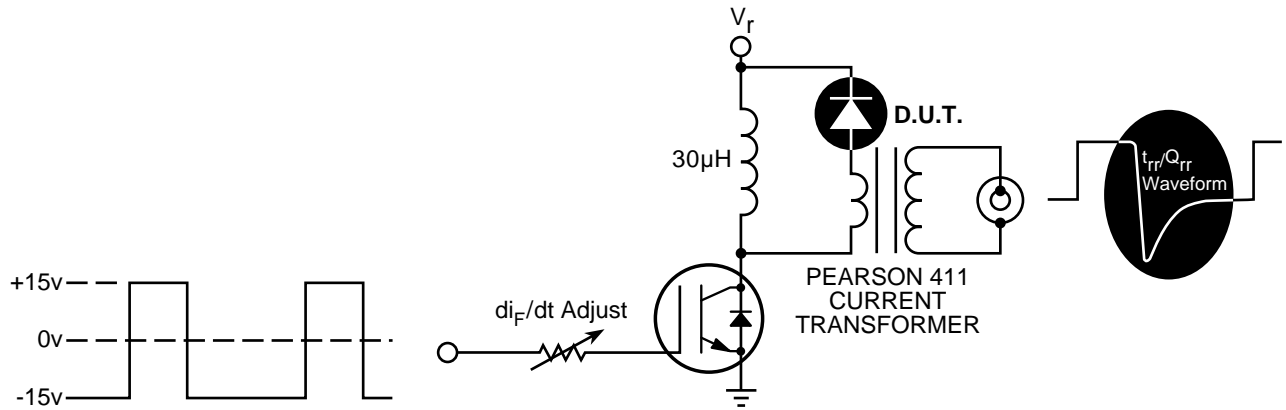

Figure 17, Diode Reverse Recovery Test Circuit and Waveforms

- ❶ I_F - Forward Conduction Current
- ❷ di_F/dt - Current Slew Rate, Rate of Forward Current Change Through Zero Crossing.
- ❸ I_{RRM} - Peak Reverse Recovery Current.
- ❹ t_{rr} - Reverse Recovery Time Measured from Point of I_F Current Falling Through Zero to a Tangent Line {❻ diM/dt } Extrapolated Through Zero Defined by 0.75 and 0.50 I_{RRM} .
- ❺ Q_{rr} - Area Under the Curve Defined by I_{RRM} and t_{rr} .
- ❻ diM/dt - Maximum Rate of Current Change During the Trailing Portion of t_{rr} .

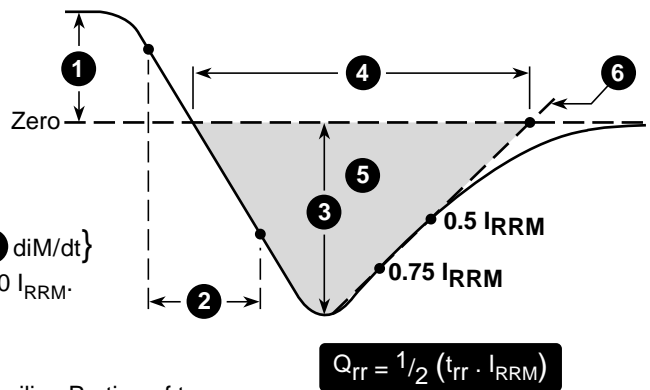

Figure 18. Diode Reverse Recovery Waveform and Definitions

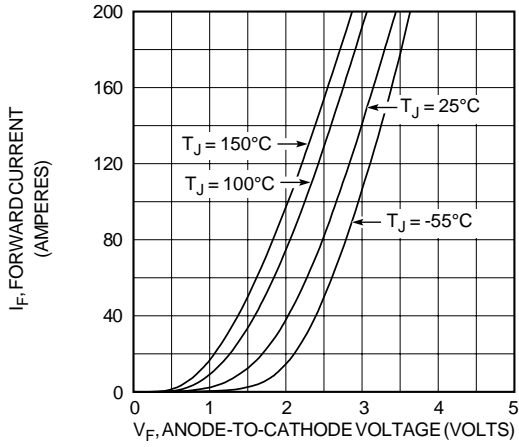

Figure 2, Forward Voltage Drop vs Forward Current

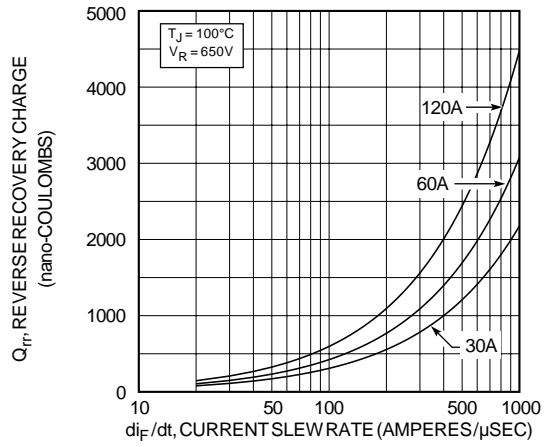

Figure 3, Reverse Recovery Charge vs Current Slew Rate

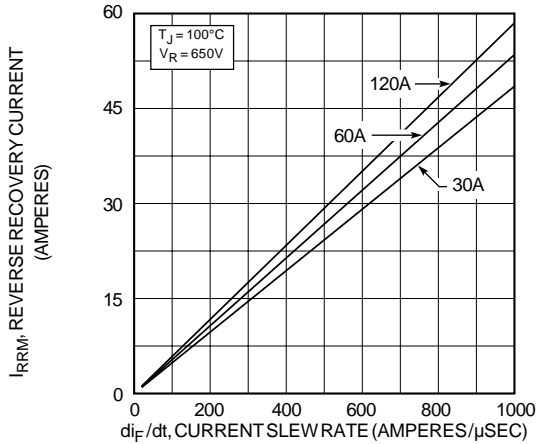

Figure 4, Reverse Recovery Current vs Current Slew Rate

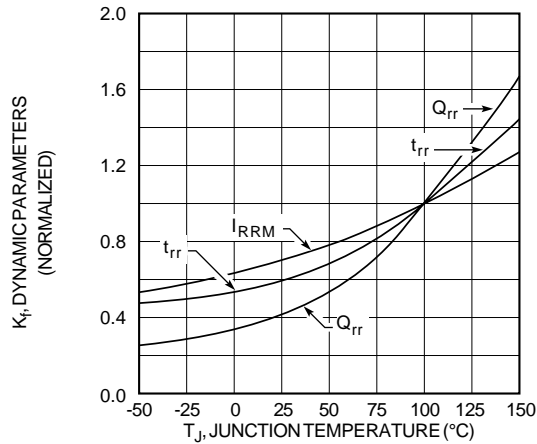

Figure 5, Dynamic Parameters vs Junction Temperature

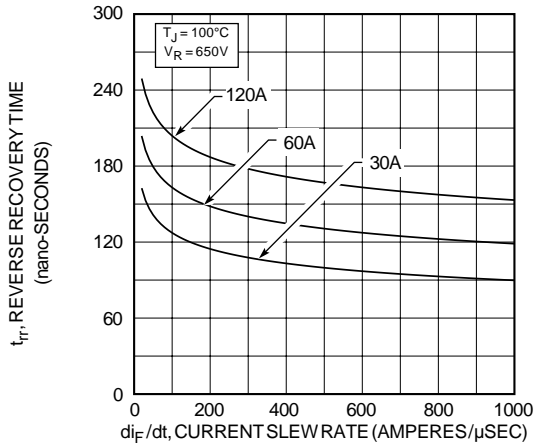

Figure 6, Reverse Recovery Time vs Current Slew Rate

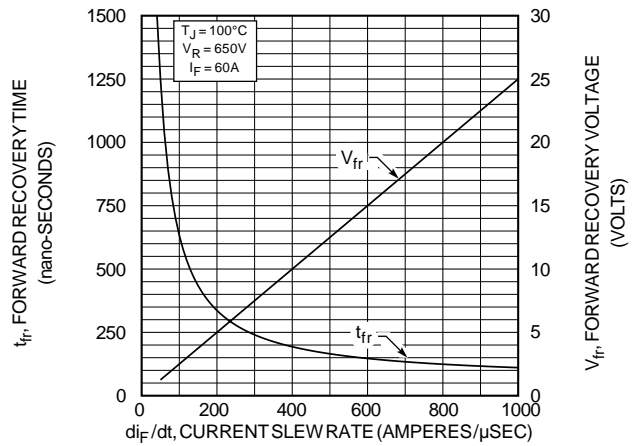

Figure 7, Forward Recovery Voltage/Time vs Current Slew Rate

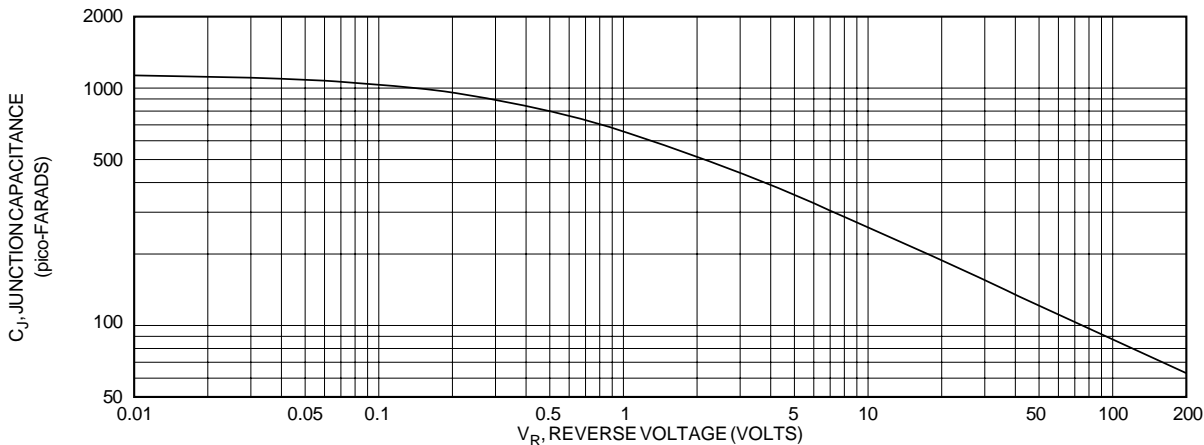
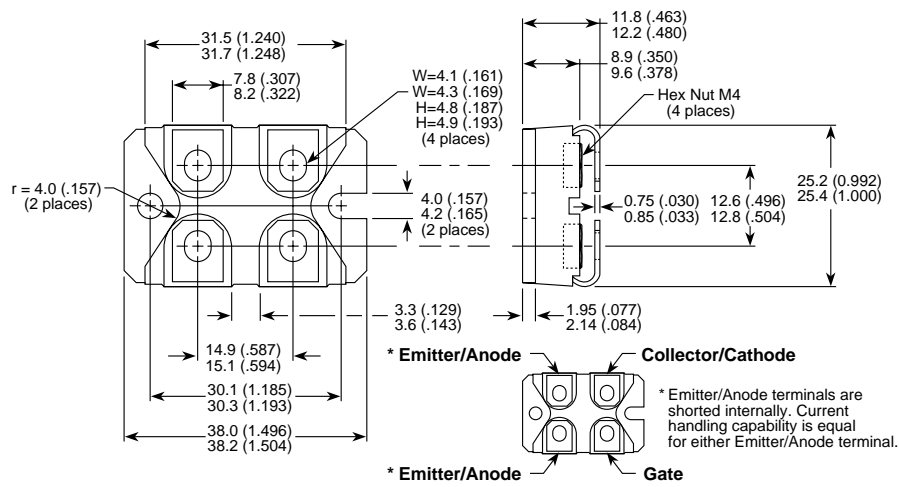

Figure 8, Junction Capacitance vs Reverse Voltage

SOT-227 (ISOTOP®) Package Outline



Dimensions in Millimeters and (Inches)

APT's devices are covered by one or more of the following U.S. patents:

4,895,810	5,045,903	5,089,434	5,182,234	5,019,522	5,262,336
5,256,583	4,748,103	5,283,202	5,231,474	5,434,095	5,528,058

X-ON Electronics

Largest Supplier of Electrical and Electronic Components

Click to view similar products for [IGBT Modules category](#):

Click to view products by [Microchip manufacturer](#):

Other Similar products are found below :

[F3L100R07W2E3_B11](#) [F3L15R12W2H3_B27](#) [F3L400R07ME4_B22](#) [F3L400R12PT4_B26](#) [F4-100R12KS4](#) [F4-50R07W2H3_B51](#) [F4-75R12KS4_B11](#) [FB15R06W1E3](#) [FB20R06W1E3_B11](#) [FD1000R33HE3-K](#) [FD200R12KE3](#) [FD300R06KE3](#) [FD300R12KE3](#) [FD300R12KS4_B5](#) [FD400R12KE3](#) [FD400R33KF2C-K](#) [FD401R17KF6C_B2](#) [FD-DF80R12W1H3_B52](#) [FF100R12KS4](#) [FF1200R17KE3_B2](#) [FF150R12KE3G](#) [FF200R06KE3](#) [FF200R06YE3](#) [FF200R12KT3](#) [FF200R12KT3_E](#) [FF200R12KT4](#) [FF200R17KE3](#) [FF300R06KE3_B2](#) [FF300R12KE4_E](#) [FF300R12KS4HOSA1](#) [FF300R12ME4_B11](#) [FF300R12MS4](#) [FF300R17ME4](#) [FF450R12ME4P](#) [FF450R17IE4](#) [FF600R12IE4V](#) [FF600R12IP4V](#) [FF800R17KE3](#) [FF900R12IE4V](#) [MIXA30W1200TED](#) [MIXA450PF1200TSF](#) [FP06R12W1T4_B3](#) [FP100R07N3E4](#) [FP100R07N3E4_B11](#) [FP10R06W1E3_B11](#) [FP10R12W1T4_B11](#) [FP10R12YT3](#) [FP10R12YT3_B4](#) [FP150R07N3E4](#) [FP15R12KT3](#)