

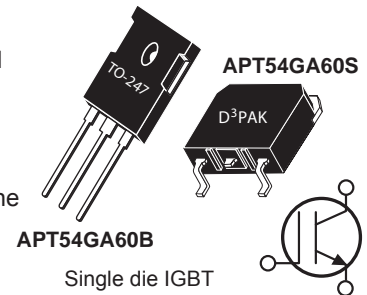

High Speed PT IGBT

POWER MOS 8® is a high speed Punch-Through switch-mode IGBT. Low E_{off} is achieved through leading technology silicon design and lifetime control processes. A reduced $E_{off} - V_{CE(ON)}$ tradeoff results in superior efficiency compared to other IGBT technologies. Low gate charge and a greatly reduced ratio of C_{res}/C_{ies} provide excellent noise immunity, short delay times and simple gate drive. The intrinsic chip gate resistance and capacitance of the poly-silicone gate structure help control di/dt during switching, resulting in low EMI, even when switching at high frequency.



FEATURES

- Fast switching with low EMI
- Very Low E_{off} for maximum efficiency
- Ultra low C_{res} for improved noise immunity
- Low conduction loss
- Low gate charge
- Increased intrinsic gate resistance for low EMI
- RoHS compliant 

TYPICAL APPLICATIONS

- ZVS phase shifted and other full bridge
- Half bridge
- High power PFC boost
- Welding
- UPS, solar, and other inverters
- High frequency, high efficiency industrial

Absolute Maximum Ratings

Symbol	Parameter	Ratings	Unit
V_{CES}	Collector Emitter Voltage	600	V
I_{C1}	Continuous Collector Current @ $T_c = 25^\circ\text{C}$	96	A
I_{C2}	Continuous Collector Current @ $T_c = 100^\circ\text{C}$	54	
I_{CM}	Pulsed Collector Current ¹	161	
V_{GE}	Gate-Emitter Voltage ²	± 30	V
P_D	Total Power Dissipation @ $T_c = 25^\circ\text{C}$	416	W
SSOA	Switching Safe Operating Area @ $T_j = 150^\circ\text{C}$	161A @ 600V	
T_J, T_{STG}	Operating and Storage Junction Temperature Range	-55 to 150	°C
T_L	Lead Temperature for Soldering: 0.063" from Case for 10 Seconds	300	

Static Characteristics

$T_J = 25^\circ\text{C}$ unless otherwise specified

Symbol	Parameter	Test Conditions	Min	Typ	Max	Unit
$V_{BR(CES)}$	Collector-Emitter Breakdown Voltage	$V_{GE} = 0V, I_C = 1.0mA$	600			V
$V_{CE(on)}$	Collector-Emitter On Voltage	$V_{GE} = 15V, I_C = 32A$		2.0	2.5	
		$T_J = 25^\circ\text{C}$ $T_J = 125^\circ\text{C}$		1.9		
$V_{GE(th)}$	Gate Emitter Threshold Voltage	$V_{GE} = V_{CE}, I_C = 1mA$	3	4.5	6	
I_{CES}	Zero Gate Voltage Collector Current	$V_{CE} = 600V, V_{GE} = 0V$			250	μA
		$T_J = 25^\circ\text{C}$ $T_J = 125^\circ\text{C}$			2500	
I_{GES}	Gate-Emitter Leakage Current	$V_{GS} = \pm 30V$			± 100	nA

Thermal and Mechanical Characteristics

Symbol	Characteristic	Min	Typ	Max	Unit
$R_{\theta JC}$	Junction to Case Thermal Resistance	-	-	.3	°C/W
W_T	Package Weight	-	5.9	-	g
Torque	Mounting Torque (TO-247 Package), 4-40 or M3 screw			10	in·lbf

Dynamic Characteristics

T_J = 25°C unless otherwise specified

APT54GA60B_S

Symbol	Parameter	Test Conditions	Min	Typ	Max	Unit
C _{ies}	Input Capacitance	Capacitance V _{GE} = 0V, V _{CE} = 25V f = 1MHz		4130		pF
C _{oes}	Output Capacitance			350		
C _{res}	Reverse Transfer Capacitance			45		
Q _g ³	Total Gate Charge	Gate Charge V _{GE} = 15V V _{CE} = 300V I _C = 32A		158		nC
Q _{ge}	Gate-Emitter Charge			26		
Q _{gc}	Gate- Collector Charge			52		
SSOA	Switching Safe Operating Area	T _J = 150°C, R _G = 4.7Ω ⁴ , V _{GE} = 15V, L = 100uH, V _{CE} = 600V	161			A
t _{d(on)}	Turn-On Delay Time	Inductive Switching (25°C) V _{CC} = 400V V _{GE} = 15V I _C = 32A R _G = 4.7Ω ⁴ T _J = +25°C		17		ns
t _r	Current Rise Time			20		
t _{d(off)}	Turn-Off Delay Time			112		
t _f	Current Fall Time			86		
E _{on2}	Turn-On Switching Energy			534		
E _{off} ⁶	Turn-Off Switching Energy		466			
t _{d(on)}	Turn-On Delay Time	Inductive Switching (125°C) V _{CC} = 400V V _{GE} = 15V I _C = 32A R _G = 4.7Ω ⁴ T _J = +125°C		16		ns
t _r	Current Rise Time			21		
t _{d(off)}	Turn-Off Delay Time			146		
t _f	Current Fall Time			145		
E _{on2}	Turn-On Switching Energy			891		
E _{off} ⁶	Turn-Off Switching Energy		838			

1 Repetitive Rating: Pulse width and case temperature limited by maximum junction temperature.

2 Pulse test: Pulse Width < 380μs, duty cycle < 2%.

3 See Mil-Std-750 Method 3471

4 R_G is external gate resistance, not including internal gate resistance or gate driver impedance. (MIC4452)

5 E_{on2} is the clamped inductive turn on energy that includes a commutating diode reverse recovery current in the IGBT turn on energy loss. A combi device is used for the clamping diode.

6 E_{off} is the clamped inductive turn-off energy measured in accordance with JEDEC standard JESD24-1.

Microsemi reserves the right to change, without notice, the specifications and information contained herein.

Typical Performance Curves

APT54GA60B_S

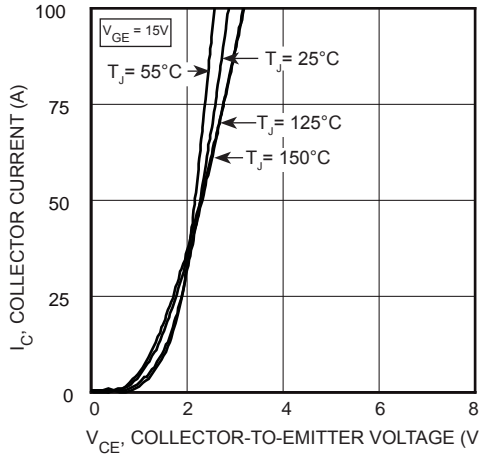

FIGURE 1, Output Characteristics ($T_J = 25^\circ\text{C}$)

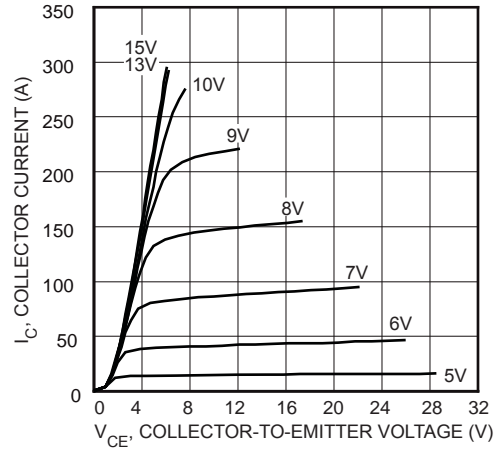

FIGURE 2, Output Characteristics ($T_J = 25^\circ\text{C}$)

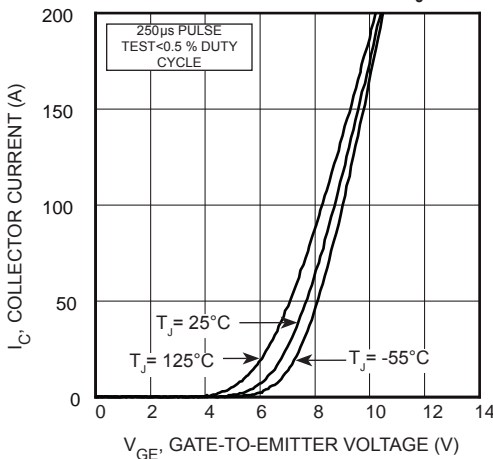

FIGURE 3, Transfer Characteristics

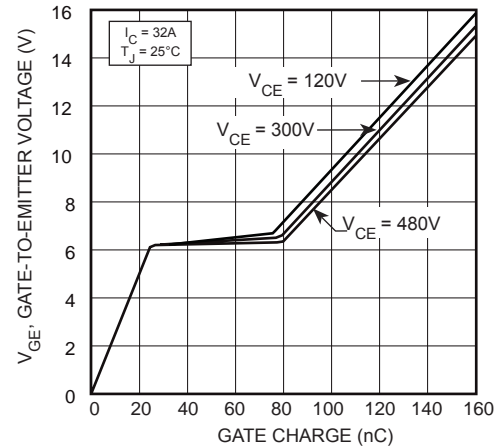

FIGURE 4, Gate charge

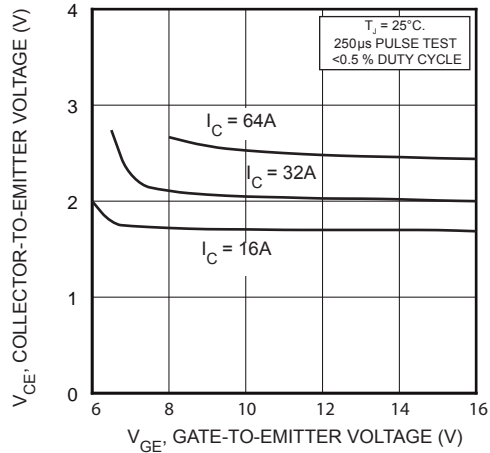

FIGURE 5, On State Voltage vs Gate-to-Emitter Voltage

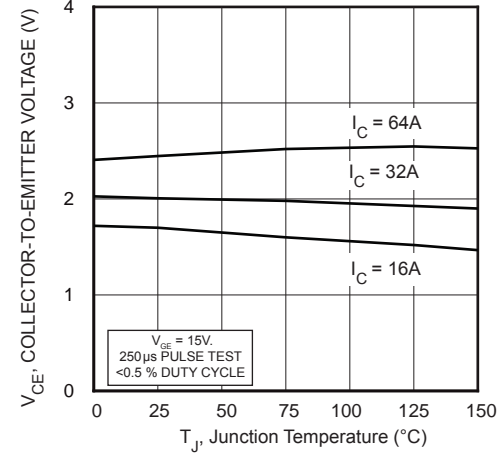

FIGURE 6, On State Voltage vs Junction Temperature

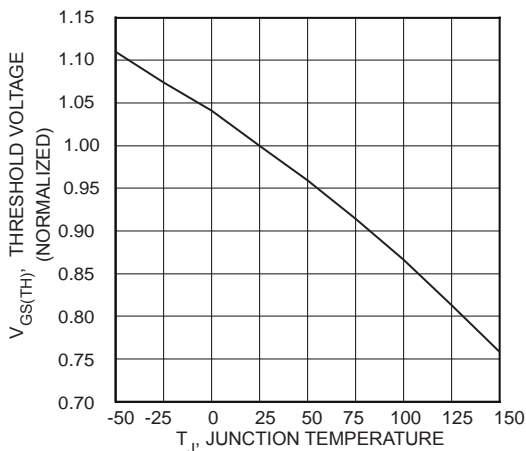

FIGURE 7, Threshold Voltage vs Junction Temperature

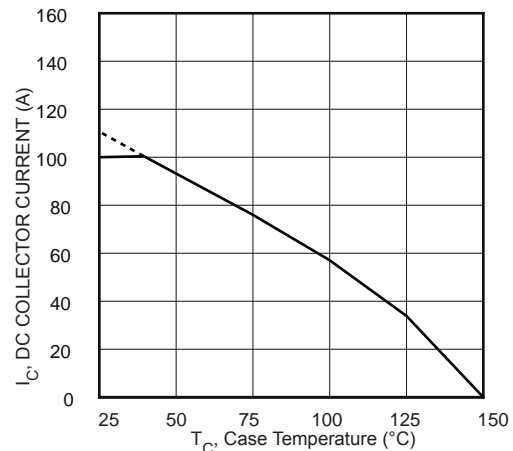

FIGURE 8, DC Collector Current vs Case Temperature

Typical Performance Curves

APT54GA60B_S

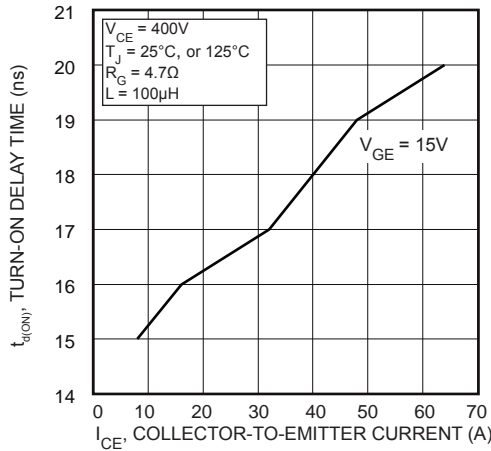

FIGURE 9, Turn-On Delay Time vs Collector Current

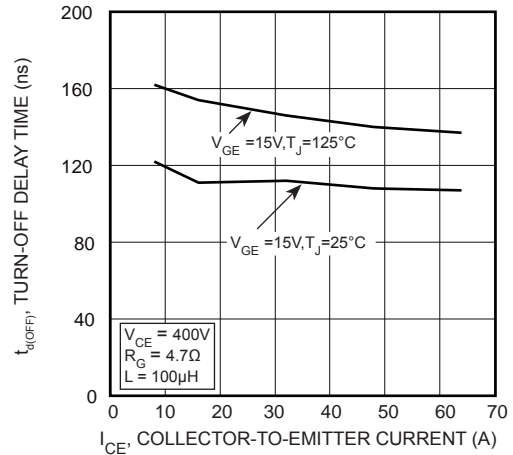

FIGURE 10, Turn-Off Delay Time vs Collector Current

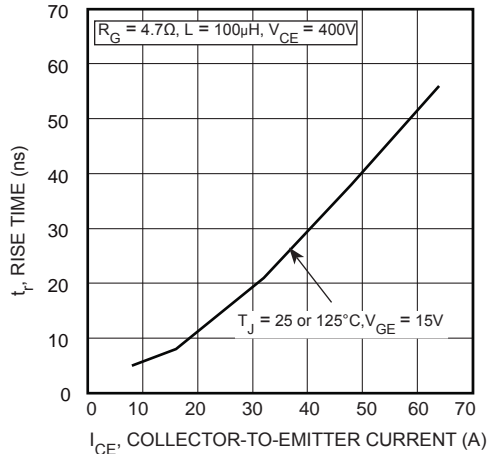

FIGURE 11, Current Rise Time vs Collector Current

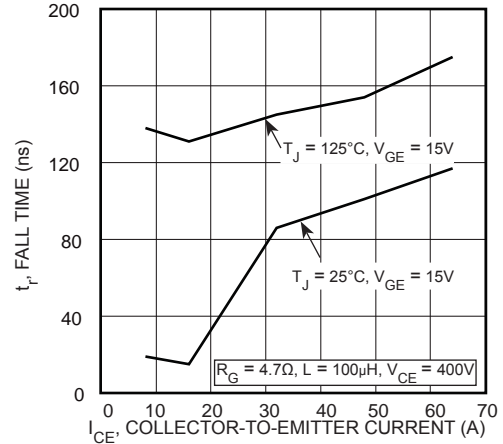

FIGURE 12, Current Fall Time vs Collector Current

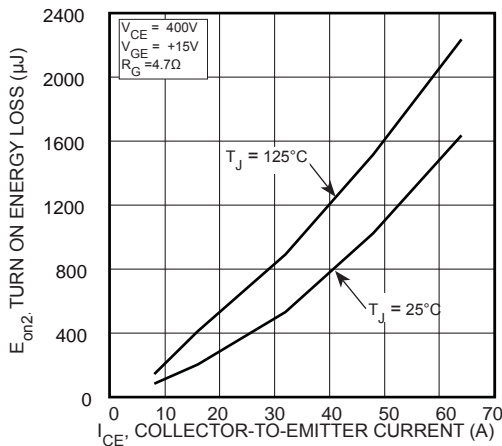

FIGURE 13, Turn-On Energy Loss vs Collector Current

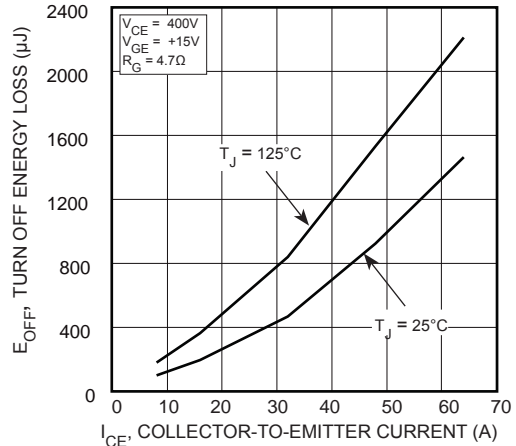

FIGURE 14, Turn-Off Energy Loss vs Collector Current

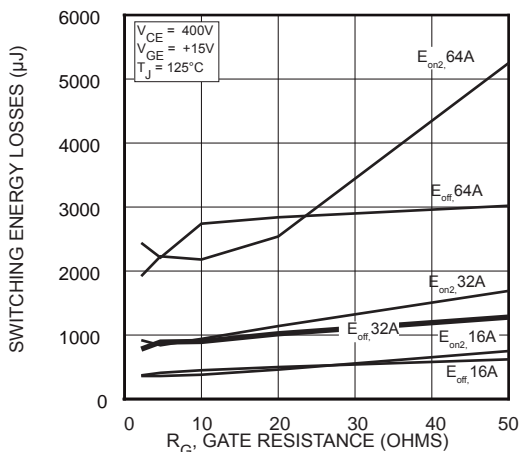

FIGURE 15, Switching Energy Losses vs Gate Resistance

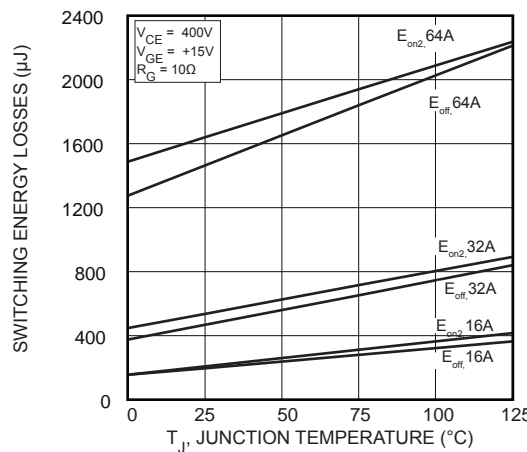

FIGURE 16, Switching Energy Losses vs Junction Temperature

Typical Performance Curves

APT54GA60B_S

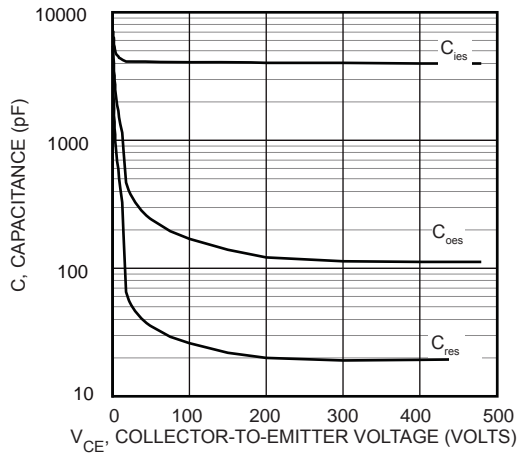

FIGURE 17, Capacitance vs Collector-To-Emitter Voltage

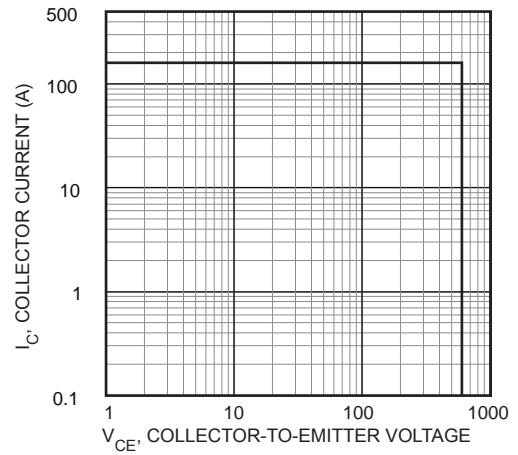

FIGURE 18, Minimum Switching Safe Operating Area

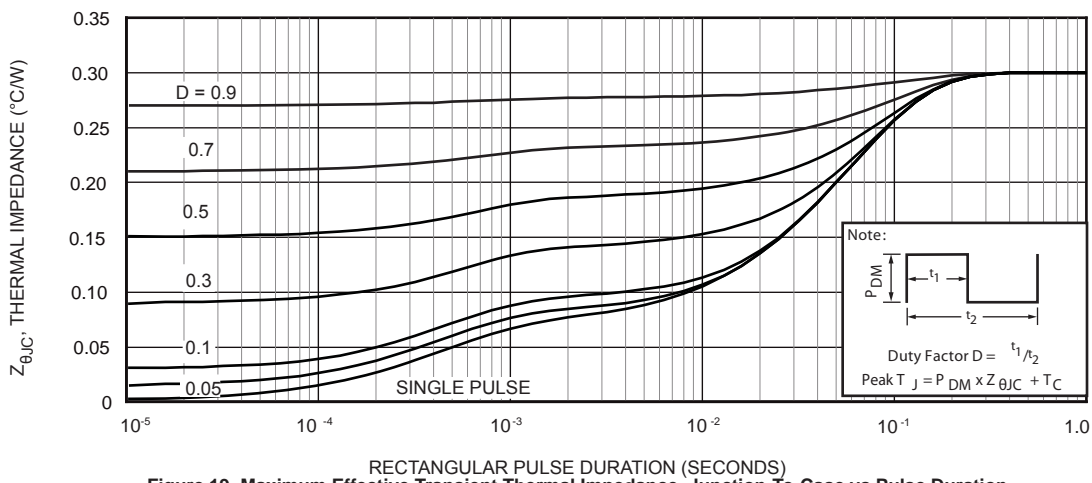

Figure 19, Maximum Effective Transient Thermal Impedance, Junction-To-Case vs Pulse Duration

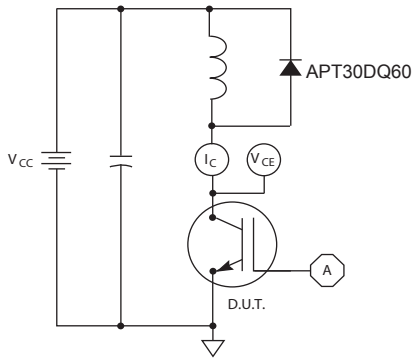

Figure 12, Inductive Switching Test Circuit

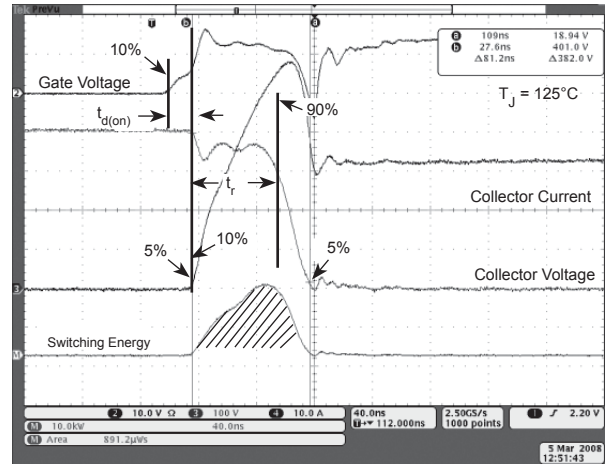

Figure 13, Turn-on Switching Waveforms and Definitions

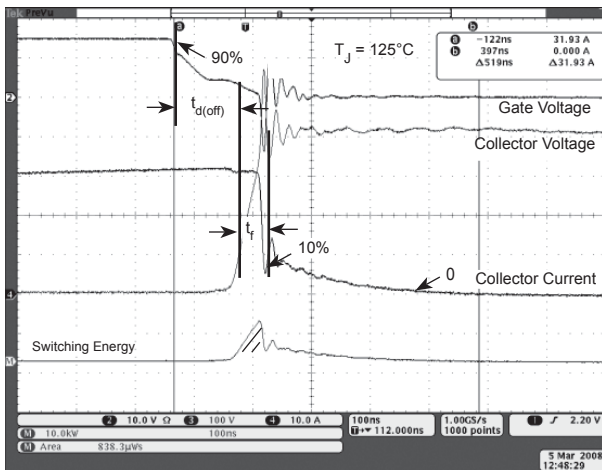
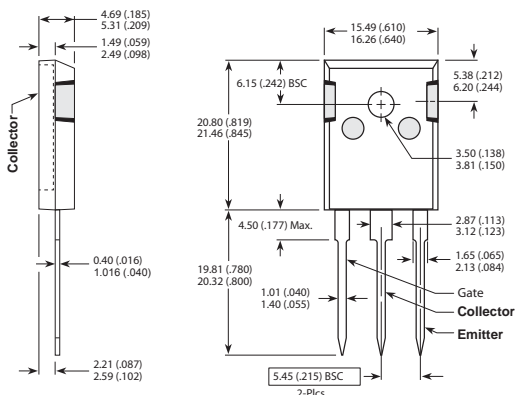

Figure 14, Turn-off Switching Waveforms and Definitions

TO-247 Package Outline

Ⓔ SAC: Tin, Silver, Copper



Dimensions in Millimeters (Inches)

D³PAK Package Outline

Ⓔ 100% Sn Plated

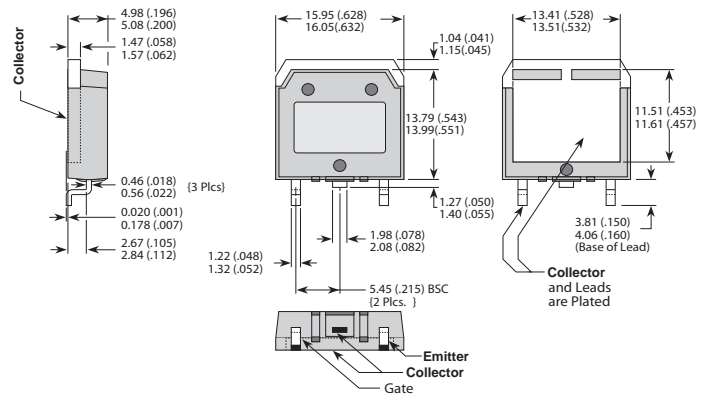

Dimensions in Millimeters (Inches)

X-ON Electronics

Largest Supplier of Electrical and Electronic Components

Click to view similar products for [IGBT Transistors category](#):

Click to view products by [Microchip manufacturer](#):

Other Similar products are found below :

[748152A](#) [APT100GT60B2RG](#) [APT13GP120BG](#) [APT15GN120BDQ1G](#) [APT20GN60BG](#) [APT20GT60BRDQ1G](#) [APT25GN120B2DQ2G](#)
[APT35GA90BD15](#) [APT36GA60BD15](#) [APT40GP60B2DQ2G](#) [APT40GP90B2DQ2G](#) [APT50GN120B2G](#) [APT50GT60BRG](#)
[APT64GA90B2D30](#) [APT70GR120J](#) [NGTB10N60FG](#) [NGTB30N60L2WG](#) [NGTG25N120FL2WG](#) [IGP30N60H3XKSA1](#) [STGB15H60DF](#)
[STGFW20V60DF](#) [STGFW30V60DF](#) [STGFW40V60F](#) [STGWA25H120DF2](#) [FGB3236_F085](#) [APT25GN120BG](#) [APT25GR120S](#)
[APT30GN60BDQ2G](#) [APT30GN60BG](#) [APT30GP60BG](#) [APT30GS60BRDQ2G](#) [APT30N60BC6](#) [APT35GP120JDQ2](#) [APT36GA60B](#)
[APT45GR65B2DU30](#) [APT50GP60B2DQ2G](#) [APT68GA60B](#) [APT70GR65B](#) [APT70GR65B2SCD30](#) [GT50JR22\(STA1ES\)](#) [TIG058E8-TL-H](#)
[IDW40E65D2](#) [SGB15N120ATMA1](#) [NGTB50N60L2WG](#) [STGB10H60DF](#) [STGB20V60F](#) [STGB40V60F](#) [STGFW80V60F](#)
[IGW40N120H3FKSA1](#) [RJH60D7BDPQ-E0#T2](#)