

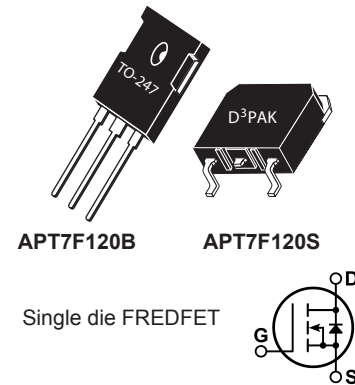

N-Channel FREDFET

Power MOS 8™ is a high speed, high voltage N-channel switch-mode power MOSFET. This 'FREDFET' version has a drain-source (body) diode that has been optimized for high reliability in ZVS phase shifted bridge and other circuits through reduced t_{rr} , soft recovery, and high recovery dv/dt capability. Low gate charge, high gain, and a greatly reduced ratio of C_{rSS}/C_{iSS} result in excellent noise immunity and low switching loss. The intrinsic gate resistance and capacitance of the poly-silicon gate structure help control di/dt during switching, resulting in low EMI and reliable paralleling, even when switching at very high frequency.



FEATURES

- Fast switching with low EMI
- Low t_{rr} for high reliability
- Ultra low C_{rSS} for improved noise immunity
- Low gate charge
- Avalanche energy rated
- RoHS compliant 

TYPICAL APPLICATIONS

- ZVS phase shifted and other full bridge
- Half bridge
- PFC and other boost converter
- Buck converter
- Single and two switch forward
- Flyback

Absolute Maximum Ratings

| Symbol | Parameter | Ratings | Unit |
|----------|-------------------------------------------------|---------|------|
| I_D | Continuous Drain Current @ $T_C = 25^\circ C$ | 7 | A |
| | Continuous Drain Current @ $T_C = 100^\circ C$ | 5 | |
| I_{DM} | Pulsed Drain Current ^① | 28 | |
| V_{GS} | Gate-Source Voltage | ±30 | V |
| E_{AS} | Single Pulse Avalanche Energy ^② | 575 | mJ |
| I_{AR} | Avalanche Current, Repetitive or Non-Repetitive | 3 | A |

Thermal and Mechanical Characteristics

| Symbol | Characteristic | Min | Typ | Max | Unit |
|-----------------|--------------------------------------------------------|-----|------|------|--------|
| P_D | Total Power Dissipation @ $T_C = 25^\circ C$ | | | 335 | W |
| $R_{\theta JC}$ | Junction to Case Thermal Resistance | | | 0.37 | °C/W |
| $R_{\theta CS}$ | Case to Sink Thermal Resistance, Flat, Greased Surface | | 0.11 | | |
| T_J, T_{STG} | Operating and Storage Junction Temperature Range | -55 | | 150 | °C |
| T_L | Soldering Temperature for 10 Seconds (1.6mm from case) | | | 300 | |
| W_T | Package Weight | | 0.22 | | oz |
| | | | 6.2 | | g |
| Torque | Mounting Torque (TO-247 Package), 6-32 or M3 screw | | | 10 | in·lbf |
| | | | | 1.1 | N·m |

Static Characteristics
T_J = 25°C unless otherwise specified
APT7F120B S

| Symbol | Parameter | Test Conditions | Min | Typ | Max | Unit |
|----------------------------------------|-------------------------------------------|----------------------------------------------------------|------|------|------|-------|
| V _{BR(DSS)} | Drain-Source Breakdown Voltage | V _{GS} = 0V, I _D = 250μA | 1200 | | | V |
| ΔV _{BR(DSS)} /ΔT _J | Breakdown Voltage Temperature Coefficient | Reference to 25°C, I _D = 250μA | | 1.41 | | V/°C |
| R _{DS(on)} | Drain-Source On Resistance ^③ | V _{GS} = 10V, I _D = 3A | | 1.57 | 2.4 | Ω |
| V _{GS(th)} | Gate-Source Threshold Voltage | V _{GS} = V _{DS} , I _D = 1mA | 2.5 | 4 | 5 | V |
| ΔV _{GS(th)} /ΔT _J | Threshold Voltage Temperature Coefficient | | | -10 | | mV/°C |
| I _{DSS} | Zero Gate Voltage Drain Current | V _{DS} = 1200V V _{GS} = 0V | | | 250 | μA |
| I _{GSS} | Gate-Source Leakage Current | V _{GS} = ±30V | | | 1000 | nA |

Dynamic Characteristics
T_J = 25°C unless otherwise specified

| Symbol | Parameter | Test Conditions | Min | Typ | Max | Unit |
|---------------------------------|----------------------------------------------|-----------------------------------------------------------------------------------------------------------------------------------------|-----|------|-----|------|
| g _{fs} | Forward Transconductance | V _{DS} = 50V, I _D = 3A | | 8 | | S |
| C _{iss} | Input Capacitance | V _{GS} = 0V, V _{DS} = 25V f = 1MHz | | 2565 | | pF |
| C _{rss} | Reverse Transfer Capacitance | | | 31 | | |
| C _{oss} | Output Capacitance | | | 190 | | |
| C _{o(cr)} ^④ | Effective Output Capacitance, Charge Related | V _{GS} = 0V, V _{DS} = 0V to 800V | | 75 | | pF |
| C _{o(er)} ^⑤ | Effective Output Capacitance, Energy Related | | | 38 | | |
| Q _g | Total Gate Charge | V _{GS} = 0 to 10V, I _D = 3A, V _{DS} = 600V | | 80 | | nC |
| Q _{gs} | Gate-Source Charge | | | 13 | | |
| Q _{gd} | Gate-Drain Charge | | | 37 | | |
| t _{d(on)} | Turn-On Delay Time | Resistive Switching V _{DD} = 800V, I _D = 3A R _G = 4.7Ω ^⑥ , V _{GG} = 15V | | 14 | | ns |
| t _r | Current Rise Time | | | 8 | | |
| t _{d(off)} | Turn-Off Delay Time | | | 45 | | |
| t _f | Current Fall Time | | | 13 | | |

Source-Drain Diode Characteristics

| Symbol | Parameter | Test Conditions | Min | Typ | Max | Unit |
|------------------|-------------------------------------------------|-----------------------------------------------------------------------------------------------|------------------------|------|------|------|
| I _S | Continuous Source Current (Body Diode) | MOSFET symbol showing the integral reverse p-n junction diode (body diode) | | | 7 | A |
| I _{SM} | Pulsed Source Current (Body Diode) ^① | | | | 28 | |
| V _{SD} | Diode Forward Voltage | I _{SD} = 3A, T _J = 25°C, V _{GS} = 0V | | | 1.2 | V |
| t _{rr} | Reverse Recovery Time | I _{SD} = 3A ^② di _{SD} /dt = 100A/μs V _{DD} = 100V | T _J = 25°C | | 190 | ns |
| | | | T _J = 125°C | | 325 | |
| Q _{rr} | Reverse Recovery Charge | | T _J = 25°C | | 0.64 | μC |
| | | | T _J = 125°C | | 1.45 | |
| I _{rrm} | Reverse Recovery Current | | T _J = 25°C | | 7.5 | A |
| | | T _J = 125°C | | 10.7 | | |
| dv/dt | Peak Recovery dv/dt | I _{SD} ≤ 3A, di/dt ≤ 1000A/μs, V _{DD} = 800V, T _J = 125°C | | | 25 | V/ns |

① Repetitive Rating: Pulse width and case temperature limited by maximum junction temperature.

② Starting at T_J = 25°C, L = 127.78mH, R_G = 4.7Ω, I_{AS} = 3A.

③ Pulse test: Pulse Width < 380μs, duty cycle < 2%.

④ C_{o(cr)} is defined as a fixed capacitance with the same stored charge as C_{oss} with V_{DS} = 67% of V_{(BR)DSS}.

⑤ C_{o(er)} is defined as a fixed capacitance with the same stored energy as C_{oss} with V_{DS} = 67% of V_{(BR)DSS}. To calculate C_{o(er)} for any value of V_{DS} less than V_{(BR)DSS}, use this equation: C_{o(er)} = -1.17E-7/V_{DS}² + 1.42E-8/V_{DS} + 2.01E-11.

⑥ R_G is external gate resistance, not including internal gate resistance or gate driver impedance. (MIC4452)

Microsemi reserves the right to change, without notice, the specifications and information contained herein.

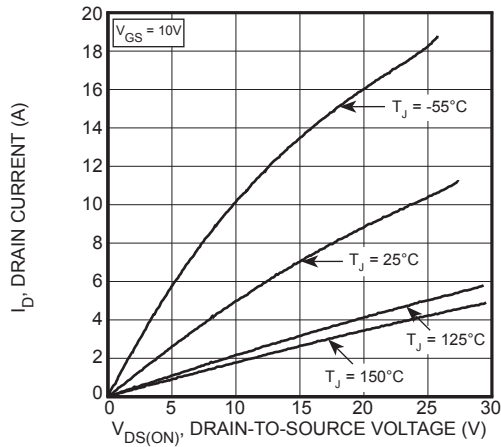

Figure 1, Output Characteristics

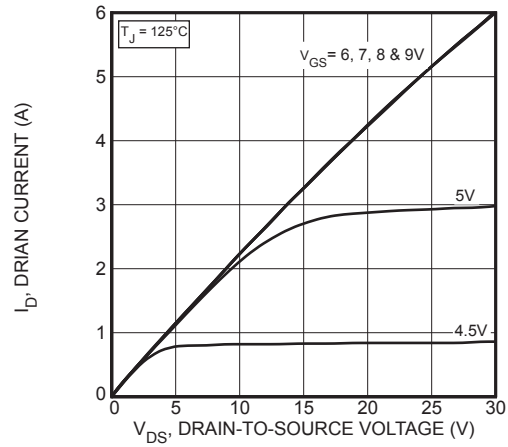

Figure 2, Output Characteristics

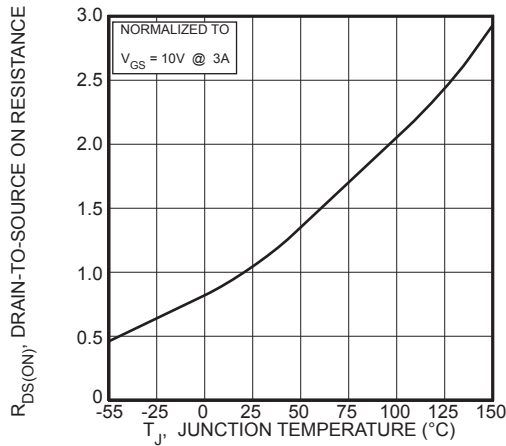

Figure 3, $R_{DS(ON)}$ vs Junction Temperature

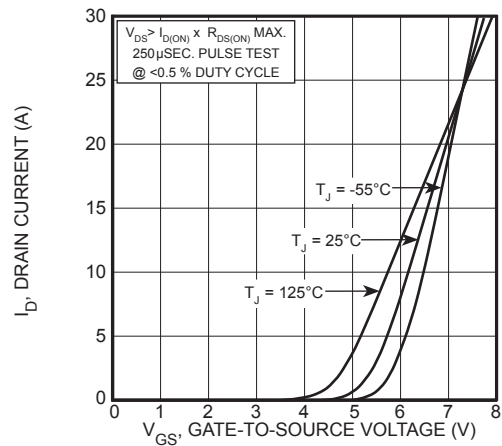

Figure 4, Transfer Characteristics

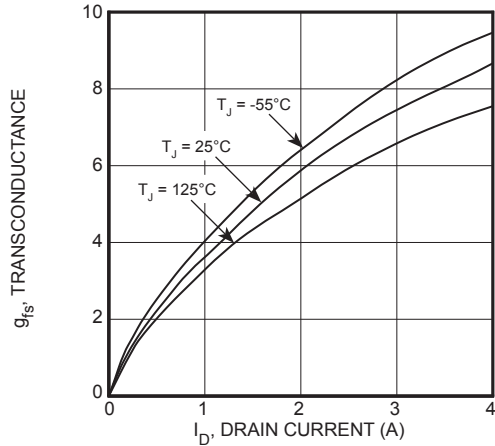

Figure 5, Gain vs Drain Current

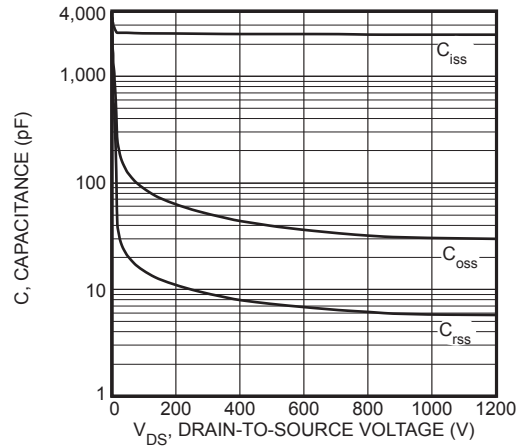

Figure 6, Capacitance vs Drain-to-Source Voltage

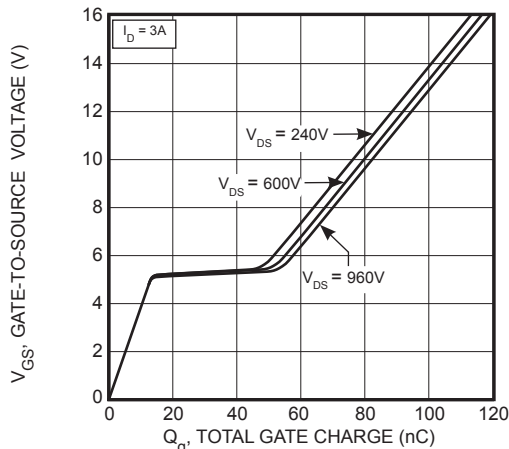

Figure 7, Gate Charge vs Gate-to-Source Voltage

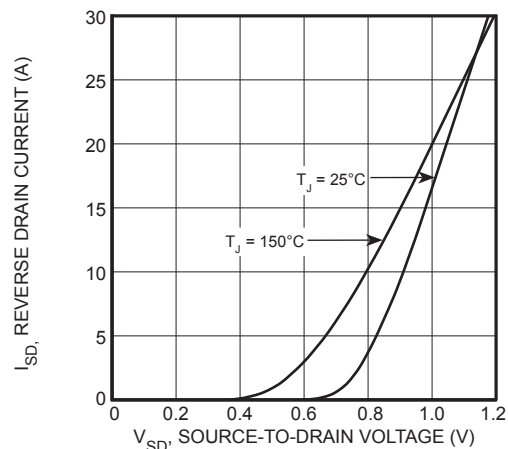

Figure 8, Reverse Drain Current vs Source-to-Drain Voltage

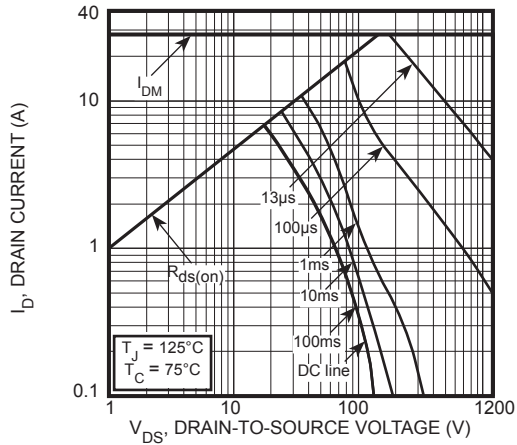

Figure 9, Forward Safe Operating Area

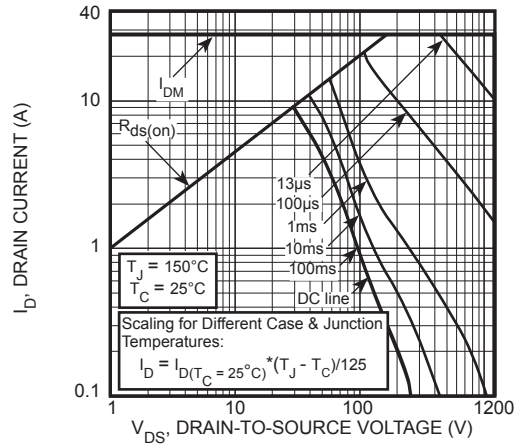

Figure 10, Maximum Forward Safe Operating Area

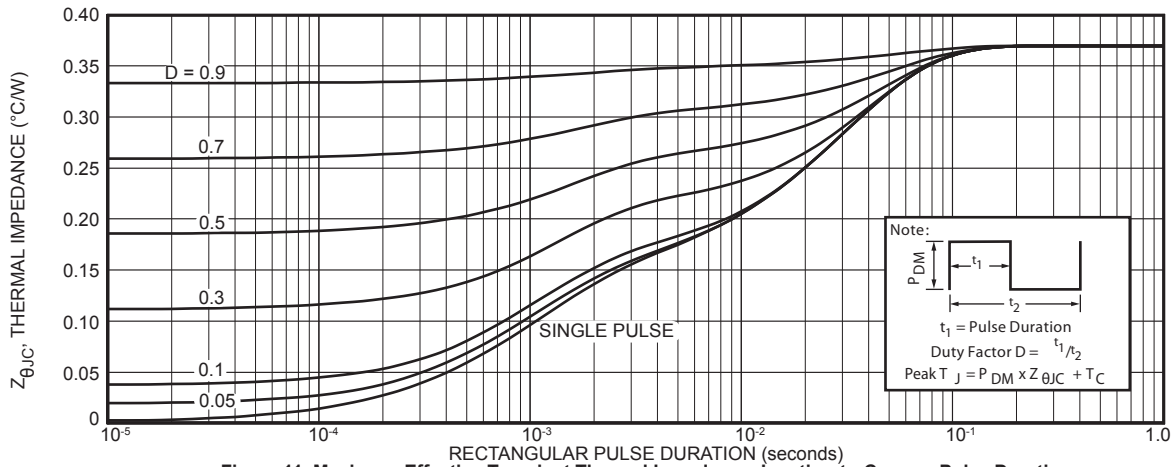
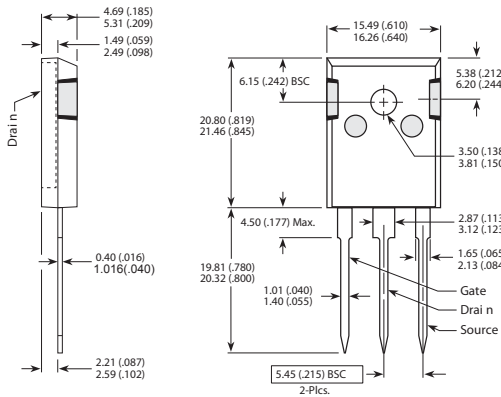

Figure 11. Maximum Effective Transient Thermal Impedance Junction-to-Case vs Pulse Duration

TO-247 (B) Package Outline

Ⓔ SAC: Tin, Silver, Copper



Dimensions in Millimeters (Inches)

D³PAK Package Outline

Ⓔ 100% Sn Plated

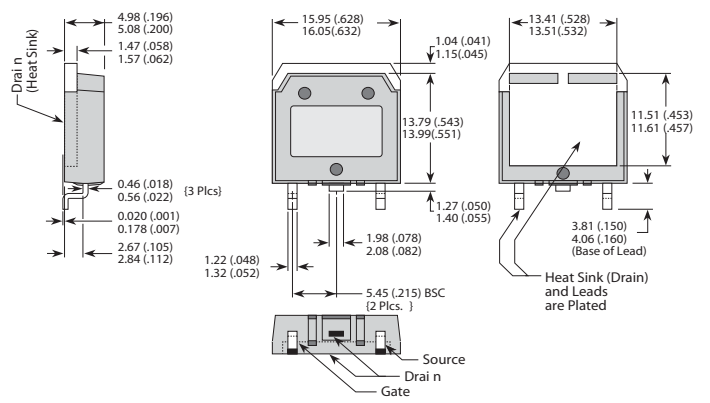

Dimensions in Millimeters (Inches)

X-ON Electronics

Largest Supplier of Electrical and Electronic Components

Click to view similar products for [MOSFET](#) category:

Click to view products by [Microchip](#) manufacturer:

Other Similar products are found below :

[614233C](#) [648584F](#) [D2003UK](#) [MCH3443-TL-E](#) [MCH6422-TL-E](#) [FDPF9N50NZ](#) [FW216A-TL-2W](#) [FW231A-TL-E](#) [APT5010JVR](#)
[NTNS3A92PZT5G](#) [IRF100S201](#) [JANTX2N5237](#) [2SK2464-TL-E](#) [2SK3818-DL-E](#) [FCA20N60_F109](#) [FDZ595PZ](#) [STD6600NT4G](#)
[FQD4P40TM_AM002](#) [FSS804-TL-E](#) [FW217A-TL-2W](#) [2SJ277-DL-E](#) [2SK1691-DL-E](#) [2SK2545\(Q,T\)](#) [D2294UK](#) [405094E](#) [423220D](#)
[MCH6646-TL-E](#) [TPCC8103,L1Q\(CM](#) [367-8430-0972-503](#) [VN1206L](#) [424134F](#) [026935X](#) [051075F](#) [SBVS138LT1G](#) [614234A](#) [715780A](#)
[NTNS3166NZT5G](#) [751625C](#) [873612G](#) [IPS70R2K0CEAKMA1](#) [RJK60S3DPP-E0#T2](#) [RJK60S5DPK-M0#T0](#) [APT8015JVFR](#) [APT5010JVFR](#)
[APT12031JFLL](#) [APT12040JVR](#) [DMN3404LQ-7](#) [NTE6400](#) [NVC3S5A51PLZT1G](#) [JANTX2N6796U](#)