

## Super Junction MOSFET

- Ultra Low  $R_{DS(ON)}$
- Low Miller Capacitance
- Ultra Low Gate Charge,  $Q_g$
- Avalanche Energy Rated
- Extreme  $dv/dt$  Rated

APT94N65B2C6

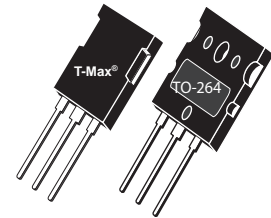

APT94N65LC6

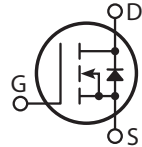

Unless stated otherwise, Microsemi discrete MOSFETs contain a single MOSFET die. This device is made with two parallel MOSFET die. It is intended for switch-mode operation. It is not suitable for linear mode operation.

### MAXIMUM RATINGS

All Ratings per die:  $T_C = 25^\circ\text{C}$  unless otherwise specified.

Symbol	Parameter	APT94N65B2_LC6	UNIT
$V_{DSS}$	Drain-Source Voltage	650	Volts
$I_D$	Continuous Drain Current @ $T_C = 25^\circ\text{C}$ <sup>1</sup>	95	Amps
	Continuous Drain Current @ $T_C = 100^\circ\text{C}$	61	
$I_{DM}$	Pulsed Drain Current <sup>2</sup>	282	
$V_{GS}$	Gate-Source Voltage Continuous	$\pm 20$	Volts
$P_D$	Total Power Dissipation @ $T_C = 25^\circ\text{C}$	833	Watts
$T_J, T_{STG}$	Operating and Storage Junction Temperature Range	-55 to 150	$^\circ\text{C}$
$T_L$	Lead Temperature: 0.063" from Case for 10 Sec.	260	
$I_{AR}$	Avalanche Current <sup>2</sup>	9.3	Amps
$E_{AR}$	Repetitive Avalanche Energy <sup>3</sup> ( $I_d = 9.3\text{A}, V_{dd} = 50\text{V}$ )	1.76	mJ
$E_{AS}$	Single Pulse Avalanche Energy ( $I_d = 9.3\text{A}, V_{dd} = 50\text{V}$ )	1160	

### STATIC ELECTRICAL CHARACTERISTICS

Symbol	Characteristic / Test Conditions	MIN	TYP	MAX	UNIT
$BV_{(DSS)}$	Drain-Source Breakdown Voltage ( $V_{GS} = 0\text{V}, I_D = 2.0\text{mA}$ )	650			Volts
$R_{DS(on)}$	Drain-Source On-State Resistance <sup>4</sup> ( $V_{GS} = 10\text{V}, I_D = 35.2\text{A}$ )		0.03	0.035	Ohms
$I_{DSS}$	Zero Gate Voltage Drain Current ( $V_{DS} = 650\text{V}, V_{GS} = 0\text{V}$ )		1.0	50	$\mu\text{A}$
	Zero Gate Voltage Drain Current ( $V_{DS} = 650\text{V}, V_{GS} = 0\text{V}, T_C = 150^\circ\text{C}$ )		100		
$I_{GSS}$	Gate-Source Leakage Current ( $V_{GS} = \pm 20\text{V}, V_{DS} = 0\text{V}$ )			$\pm 200$	nA
$V_{GS(th)}$	Gate Threshold Voltage ( $V_{DS} = V_{GS}, I_D = 3.5\text{mA}$ )	2.5	3	3.5	Volts

 CAUTION: These Devices are Sensitive to Electrostatic Discharge. Proper Handling Procedures Should Be Followed.

"COOLMOS™" comprise a new family of transistors developed by Infineon Technologies AG. "COOLMOS" is a trademark of Infineon Technologies AG."

Microsemi Website - <http://www.microsemi.com>

## DYNAMIC CHARACTERISTICS

APT94N65B2\_LC6

Symbol	Characteristic	Test Conditions	MIN	TYP	MAX	UNIT
$C_{iss}$	Input Capacitance	$V_{GS} = 0V$ $V_{DS} = 25V$ $f = 1\text{ MHz}$		8140		pF
$C_{oss}$	Output Capacitance			5451		
$C_{rss}$	Reverse Transfer Capacitance			603		
$Q_g$	Total Gate Charge <sup>⑤</sup>	$V_{GS} = 10V$ $V_{DD} = 300V$ $I_D = 94A @ 25^\circ C$		320		nC
$Q_{gs}$	Gate-Source Charge			50		
$Q_{gd}$	Gate-Drain ("Miller") Charge			168		
$t_{d(on)}$	Turn-on Delay Time	<b>INDUCTIVE SWITCHING</b> $V_{GS} = 15V$ $V_{DD} = 400V$ $I_D = 94A @ 25^\circ C$ $R_G = 4.3\Omega$		26		ns
$t_r$	Rise Time			59		
$t_{d(off)}$	Turn-off Delay Time			323		
$t_f$	Fall Time			172		
$E_{on}$	Turn-on Switching Energy <sup>⑥</sup>	<b>INDUCTIVE SWITCHING @ 25°C</b> $V_{DD} = 400V, V_{GS} = 15V$ $I_D = 94A, R_G = 4.3\Omega$		2916		μJ
$E_{off}$	Turn-off Switching Energy			3257		
$E_{on}$	Turn-on Switching Energy <sup>⑥</sup>	<b>INDUCTIVE SWITCHING @ 125°C</b> $V_{DD} = 400V, V_{GS} = 15V$ $I_D = 94A, R_G = 4.3\Omega$		3947		
$E_{off}$	Turn-off Switching Energy			4034		

## SOURCE-DRAIN DIODE RATINGS AND CHARACTERISTICS

Symbol	Characteristic / Test Conditions	MIN	TYP	MAX	UNIT
$I_S$	Continuous Source Current (Body Diode)			92.6	Amps
$I_{SM}$	Pulsed Source Current <sup>②</sup> (Body Diode)			282	
$V_{SD}$	Diode Forward Voltage <sup>④</sup> ( $V_{GS} = 0V, I_S = -52.4A$ )		0.9	1.2	Volts
$dv/dt$	Peak Diode Recovery $dv/dt$ <sup>⑦</sup>			15	V/ns
$t_{rr}$	Reverse Recovery Time ( $I_S = -94A, di/dt = 100A/\mu s$ )	$T_j = 25^\circ C$		1063	ns
$Q_{rr}$	Reverse Recovery Charge ( $I_S = -94A, di/dt = 100A/\mu s$ )	$T_j = 25^\circ C$		39	μC
$I_{RRM}$	Peak Recovery Current ( $I_S = -94A, di/dt = 100A/\mu s$ )	$T_j = 25^\circ C$		63	Amps

## THERMAL CHARACTERISTICS

Symbol	Characteristic	MIN	TYP	MAX	UNIT
$R_{\theta JC}$	Junction to Case			0.15	°C/W
$R_{\theta JA}$	Junction to Ambient			31	

- Continuous current limited by package lead temperature.
  - Repetitive Rating: Pulse width limited by maximum junction temperature
  - Repetitive avalanche causes additional power losses that can be calculated as  $P_{AV} = E_{AR} \cdot f$ . Pulse width tp limited by  $T_j$  max.
  - Pulse Test: Pulse width < 380 μs, Duty Cycle < 2%
  - See MIL-STD-750 Method 3471
  - Eon includes diode reverse recovery.
  - Maximum diode commutation speed = di/dt 300A/μs
- Microsemi reserves the right to change, without notice, the specifications and information contained herein.

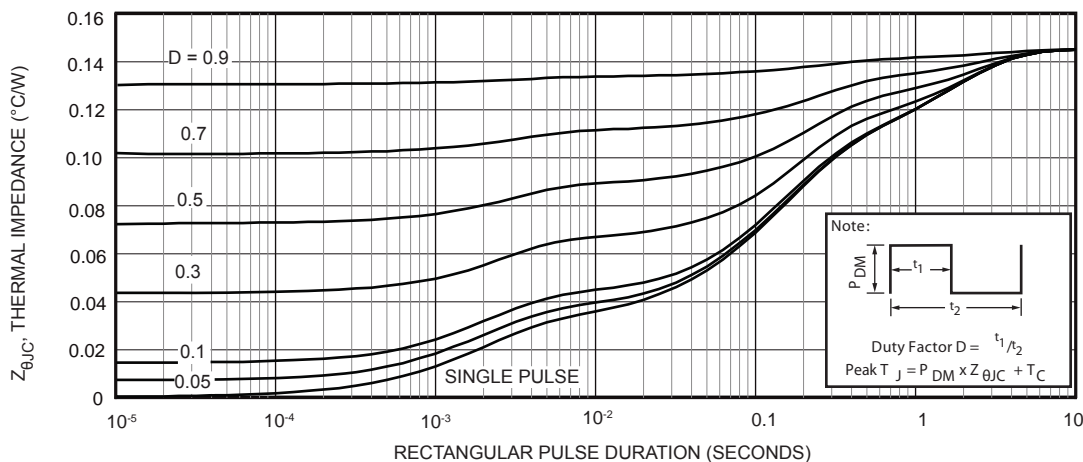

Figure 1, Maximum Effective Transient Thermal Impedance, Junction-To-Case vs Pulse Duration

# Typical Performance Curves

APT94N65B2\_LC6

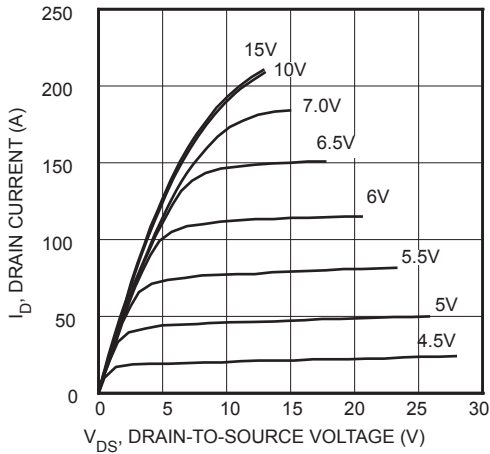

FIGURE 2, Low Voltage Output Characteristics

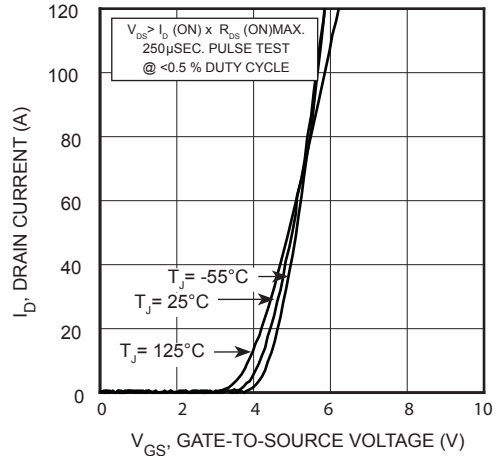

FIGURE 3, Transfer Characteristics

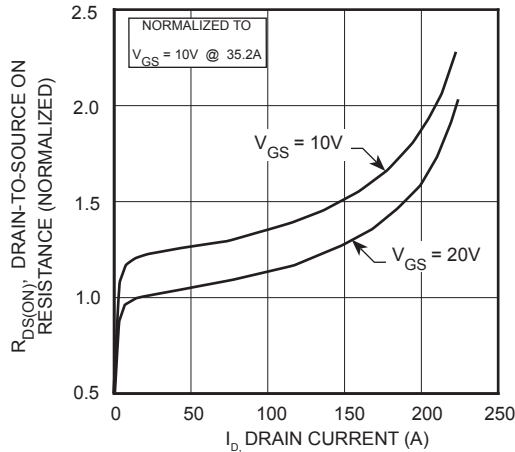

FIGURE 4,  $R_{DS(ON)}$  vs Drain Current

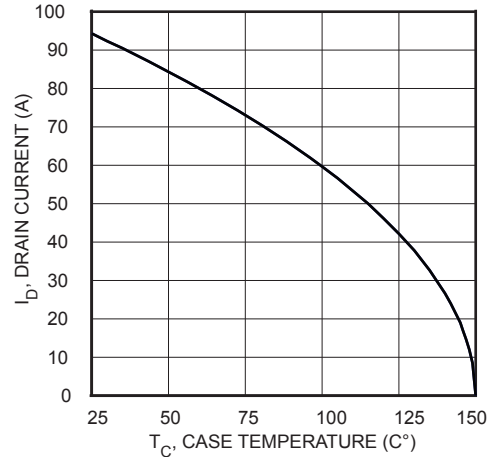

FIGURE 5, Maximum Drain Current vs Case Temperature

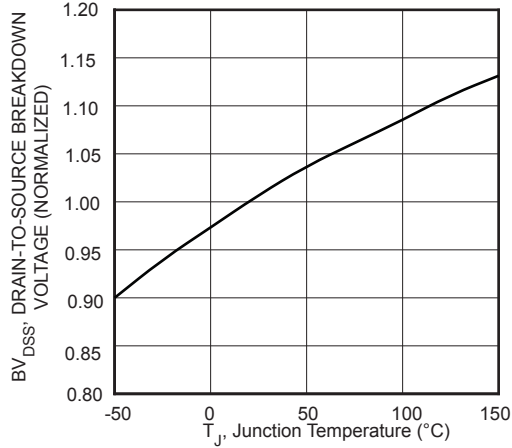

FIGURE 6, Breakdown Voltage vs Temperature

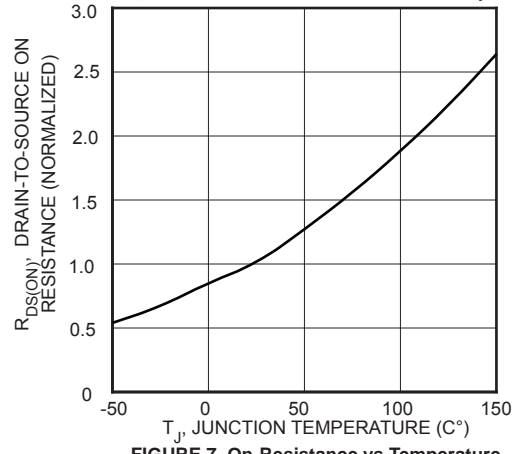

FIGURE 7, On-Resistance vs Temperature

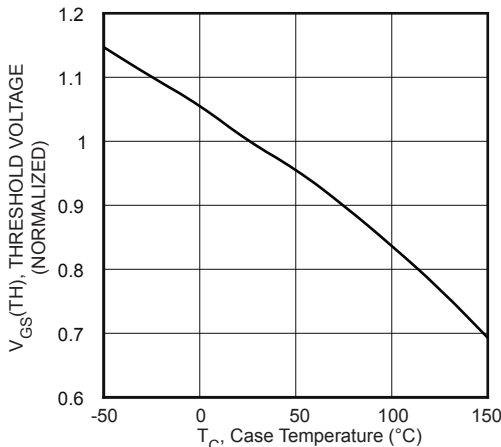

FIGURE 8, Threshold Voltage vs Temperature

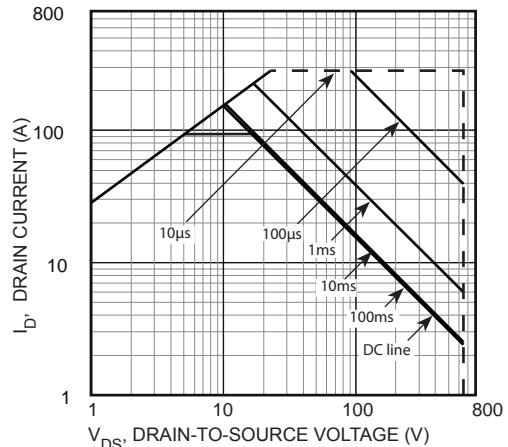

FIGURE 9, Maximum Safe Operating Area

# Typical Performance Curves

APT94N65B2\_LC6

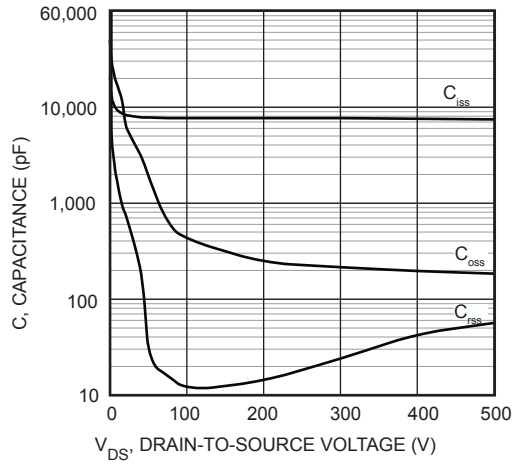

FIGURE 10, Capacitance vs Collector-To-Emitter Voltage

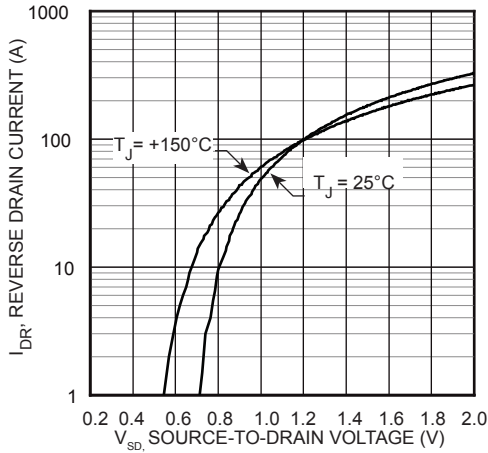

FIGURE 12, Source-Drain Diode Forward Voltage

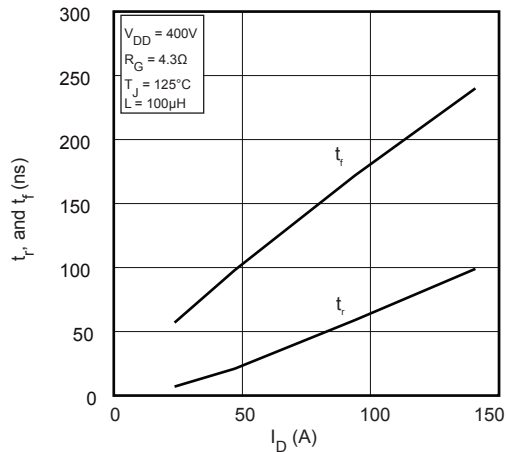

FIGURE 14, Rise and Fall Times vs Current

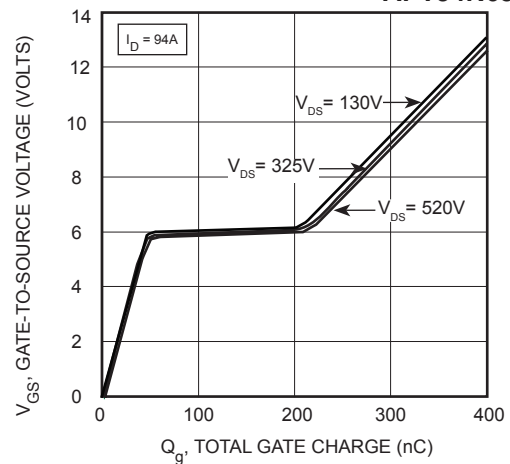

FIGURE 11, Gate Charges vs Gate-To-Source Voltage

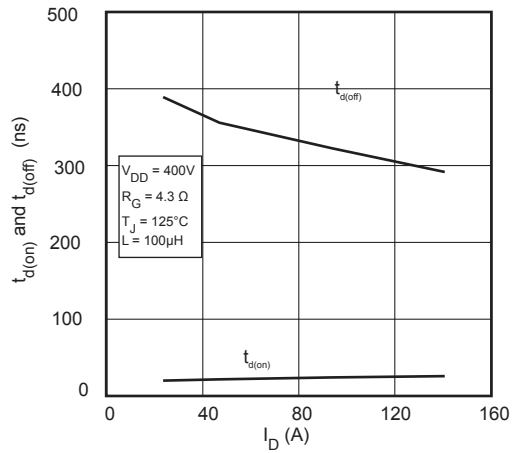

FIGURE 13, Delay Times vs Current

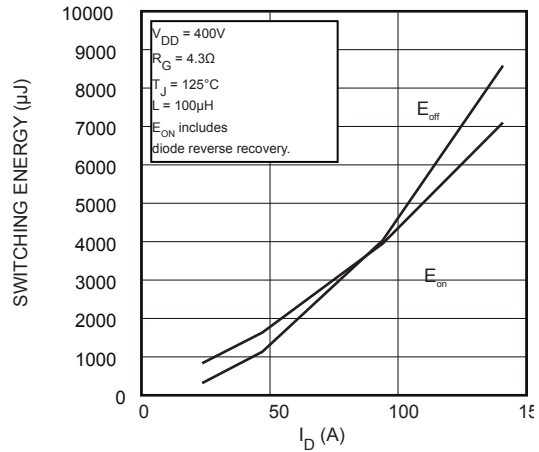

FIGURE 15, Switching Energy vs Current

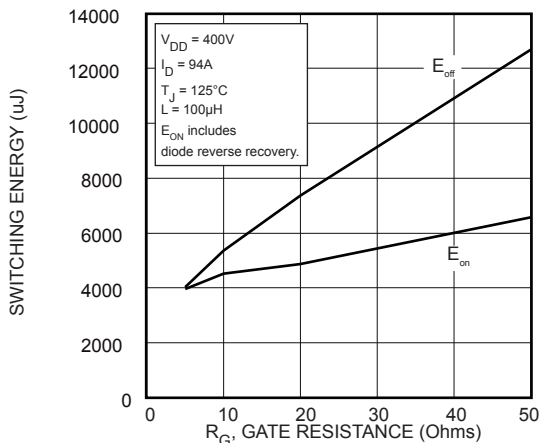

FIGURE 16, Switching Energy vs Gate Resistance

# Typical Performance Curves

APT94N65B2\_LC6

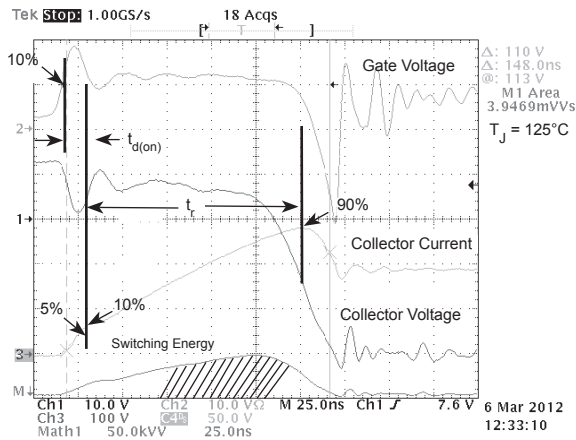

Figure 17, Turn-on Switching Waveforms and Definitions

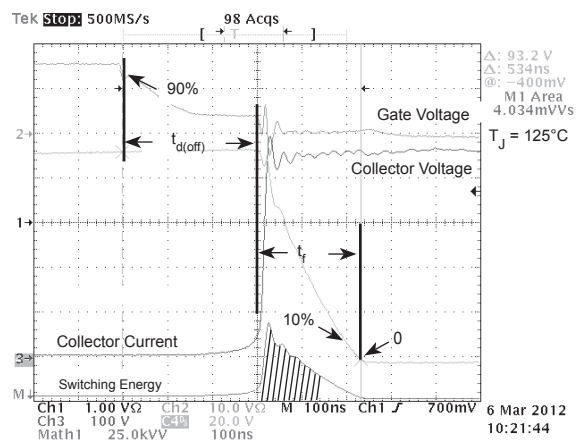

Figure 18, Turn-off Switching Waveforms and Definitions

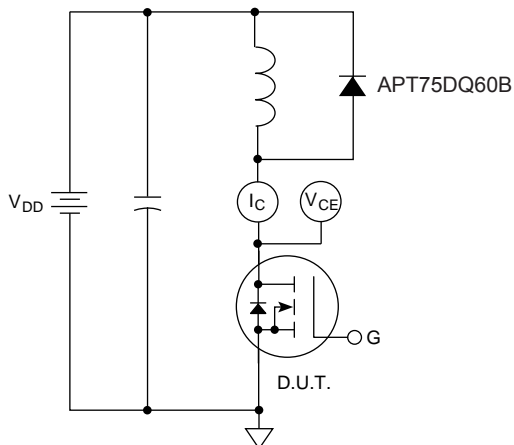
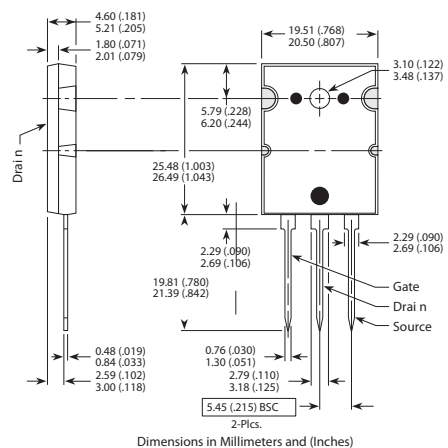
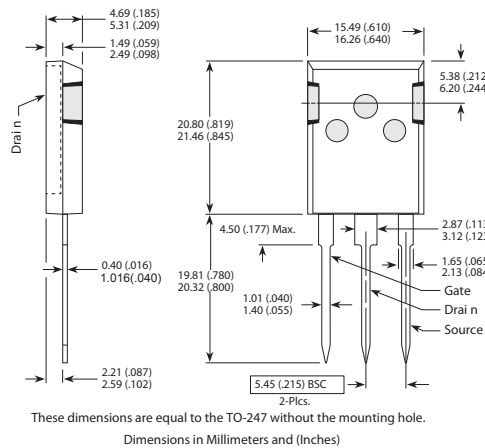

Figure 19, Inductive Switching Test Circuit

## T-MAX® (B2) Package Outline

## TO-264 (L) Package Outline

e3 100% Sn Plated



## X-ON Electronics

Largest Supplier of Electrical and Electronic Components

*Click to view similar products for [MOSFET](#) category:*

*Click to view products by [Microchip](#) manufacturer:*

Other Similar products are found below :

[614233C](#) [648584F](#) [IRFD120](#) [JANTX2N5237](#) [FCA20N60\\_F109](#) [FDZ595PZ](#) [2SK2545\(Q,T\)](#) [405094E](#) [423220D](#) [TPCC8103,L1Q\(CM](#)  
[MIC4420CM-TR](#) [VN1206L](#) [614234A](#) [715780A](#) [NTNS3166NZT5G](#) [SSM6J414TU,LF\(T](#) [751625C](#) [BUK954R8-60E](#) [NTE6400](#) [SQJ402EP-](#)  
[T1-GE3](#) [2SK2614\(TE16L1,Q\)](#) [2N7002KW-FAI](#) [DMN1017UCP3-7](#) [EFC2J004NUZTDG](#) [ECH8691-TL-W](#) [FCAB21350L1](#) [P85W28HP2F-](#)  
[7071](#) [DMN1053UCP4-7](#) [NTE221](#) [NTE222](#) [NTE2384](#) [NTE2903](#) [NTE2941](#) [NTE2945](#) [NTE2946](#) [NTE2960](#) [NTE2967](#) [NTE2969](#) [NTE2976](#)  
[NTE6400A](#) [NTE2910](#) [NTE2916](#) [NTE2956](#) [NTE2911](#) [DMN2080UCB4-7](#) [TK10A80W,S4X\(S](#) [SSM6P69NU,LF](#) [DMP22D4UFO-7B](#)  
[DMN1006UCA6-7](#) [DMN16M9UCA6-7](#)