

**Full – Bridge + boost chopper  
CoolMOS Power module**

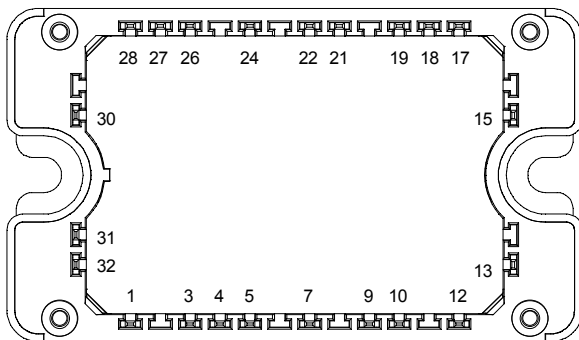
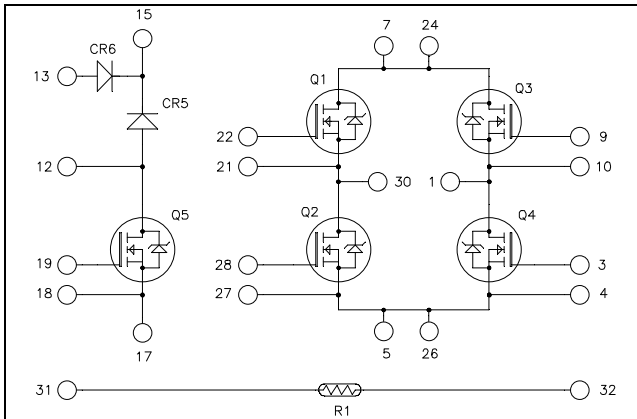

All multiple inputs and outputs must be shorted together  
7/24 ; 5/26

**All ratings @  $T_j = 25^\circ\text{C}$  unless otherwise specified**

## 1. Full bridge switches

### 1.1 CoolMOS™ characteristics (Per CoolMOS™)

#### Absolute maximum ratings

Symbol	Parameter	Max ratings	Unit
$V_{DSS}$	Drain - Source Breakdown Voltage	600	V
$I_D$	Continuous Drain Current	$T_c = 25^\circ\text{C}$	39
		$T_c = 80^\circ\text{C}$	29
$I_{DM}$	Pulsed Drain current	160	A
$V_{GS}$	Gate - Source Voltage	$\pm 20$	V
$R_{DSon}$	Drain - Source ON Resistance	70	$m\Omega$
$P_D$	Maximum Power Dissipation	$T_c = 25^\circ\text{C}$	250
$I_{AR}$	Avalanche current (repetitive and non repetitive)	20	A
$E_{AR}$	Repetitive Avalanche Energy	1	mJ
$E_{AS}$	Single Pulse Avalanche Energy	1800	

**CAUTION:** These Devices are sensitive to Electrostatic Discharge. Proper Handling Procedures Should Be Followed. See application note APT0502 on [www.microsemi.com](http://www.microsemi.com)

#### CoolMOS™ Q1 to Q4:

$V_{DSS} = 600\text{V}$

$R_{DSon} = 70m\Omega \text{ max @ } T_j = 25^\circ\text{C}$

#### CoolMOS™ Q5:

$V_{DSS} = 600\text{V}$

$R_{DSon} = 45m\Omega \text{ max @ } T_j = 25^\circ\text{C}$

#### Application

- Solar converter

#### Features

- CoolMOS™**
  - Ultra low  $R_{DSon}$
  - Low Miller capacitance
  - Ultra low gate charge
  - Avalanche energy rated

- Very low stray inductance
- Kelvin source for easy drive
- Internal thermistor for temperature monitoring
- High level of integration

#### Benefits

- Optimized conduction & switching losses
- Direct mounting to heatsink (isolated package)
- Low junction to case thermal resistance
- Solderable terminals both for power and signal for easy PCB mounting
- Low profile
- Easy paralleling due to positive  $T_C$  of  $V_{CEsat}$
- RoHS Compliant

**Electrical Characteristics**

Symbol	Characteristic	Test Conditions		Min	Typ	Max	Unit
I <sub>DSS</sub>	Zero Gate Voltage Drain Current	V <sub>GS</sub> = 0V, V <sub>DS</sub> = 600V	T <sub>j</sub> = 25°C			25	μA
		V <sub>GS</sub> = 0V, V <sub>DS</sub> = 600V	T <sub>j</sub> = 125°C			250	
R <sub>DS(on)</sub>	Drain – Source on Resistance	V <sub>GS</sub> = 10V, I <sub>D</sub> = 39A				70	mΩ
V <sub>GS(th)</sub>	Gate Threshold Voltage	V <sub>GS</sub> = V <sub>DS</sub> , I <sub>D</sub> = 2.7mA		2.1	3	3.9	V
I <sub>GSS</sub>	Gate – Source Leakage Current	V <sub>GS</sub> = ±20 V, V <sub>DS</sub> = 0V				±100	nA

**Dynamic Characteristics**

Symbol	Characteristic	Test Conditions		Min	Typ	Max	Unit
C <sub>iss</sub>	Input Capacitance	V <sub>GS</sub> = 0V			7		nF
C <sub>oss</sub>	Output Capacitance	V <sub>DS</sub> = 25V			2.56		
C <sub>rss</sub>	Reverse Transfer Capacitance	f = 1MHz			0.21		
Q <sub>g</sub>	Total gate Charge	V <sub>GS</sub> = 10V			259		nC
Q <sub>gs</sub>	Gate – Source Charge	V <sub>Bus</sub> = 300V			29		
Q <sub>gd</sub>	Gate – Drain Charge	I <sub>D</sub> = 39A			111		
T <sub>d(on)</sub>	Turn-on Delay Time	<b>Inductive Switching @ 125°C</b>			21		ns
T <sub>r</sub>	Rise Time	V <sub>GS</sub> = 15V			30		
T <sub>d(off)</sub>	Turn-off Delay Time	V <sub>Bus</sub> = 400V			283		
T <sub>f</sub>	Fall Time	I <sub>D</sub> = 39A R <sub>G</sub> = 5Ω			84		
E <sub>off</sub>	Turn-off Switching Energy	V <sub>GS</sub> = 15V V <sub>Bus</sub> = 400V	T <sub>j</sub> = 25°C		980		μJ
E <sub>off</sub>	Turn-off Switching Energy	I <sub>D</sub> = 39A R <sub>G</sub> = 5Ω	T <sub>j</sub> = 125°C		1206		
R <sub>thJC</sub>	Junction to Case Thermal resistance					0.5	°C/W

**Source - Drain diode ratings and characteristics**

Symbol	Characteristic	Test Conditions		Min	Typ	Max	Unit
I <sub>S</sub>	Continuous Source current (Body diode)	T <sub>c</sub> = 25°C			39		A
		T <sub>c</sub> = 80°C			29		
V <sub>SD</sub>	Diode Forward Voltage	V <sub>GS</sub> = 0V, I <sub>S</sub> = - 39A				1.2	V
dv/dt	Peak Diode Recovery ❶					6	V/ns
t <sub>rr</sub>	Reverse Recovery Time	I <sub>S</sub> = - 39A V <sub>R</sub> = 350V	T <sub>j</sub> = 25°C		580		ns
Q <sub>rr</sub>	Reverse Recovery Charge	di <sub>S</sub> /dt = 100A/μs	T <sub>j</sub> = 25°C		23		μC

❶ dv/dt numbers reflect the limitations of the circuit rather than the device itself.

$$I_S \leq -39A \quad di/dt \leq 100A/\mu s \quad V_R \leq V_{DSS} \quad T_j \leq 150^\circ C$$

**2. Boost chopper Q5, CR5**
**2.1 Q5 CoolMOS™ characteristics**
**Absolute maximum ratings**

<i>Symbol</i>	<i>Parameter</i>	<i>Max ratings</i>	<i>Unit</i>
V <sub>DSS</sub>	Drain - Source Breakdown Voltage	600	V
I <sub>D</sub>	Continuous Drain Current	T <sub>c</sub> = 25°C	49
		T <sub>c</sub> = 80°C	38
I <sub>DM</sub>	Pulsed Drain current	130	A
V <sub>GS</sub>	Gate - Source Voltage	±20	V
R <sub>DS(on)</sub>	Drain - Source ON Resistance	45	mΩ
P <sub>D</sub>	Maximum Power Dissipation	T <sub>c</sub> = 25°C	250
I <sub>AR</sub>	Avalanche current (repetitive and non repetitive)	15	A
E <sub>AR</sub>	Repetitive Avalanche Energy	3	mJ
E <sub>AS</sub>	Single Pulse Avalanche Energy	1900	

**Electrical Characteristics**

<i>Symbol</i>	<i>Characteristic</i>	<i>Test Conditions</i>	<i>Min</i>	<i>Typ</i>	<i>Max</i>	<i>Unit</i>
I <sub>DSS</sub>	Zero Gate Voltage Drain Current	V <sub>GS</sub> = 0V, V <sub>DS</sub> = 600V	T <sub>j</sub> = 25°C		250	μA
		V <sub>GS</sub> = 0V, V <sub>DS</sub> = 600V	T <sub>j</sub> = 125°C		500	
R <sub>DS(on)</sub>	Drain – Source on Resistance	V <sub>GS</sub> = 10V, I <sub>D</sub> = 24.5A		40	45	mΩ
V <sub>GS(th)</sub>	Gate Threshold Voltage	V <sub>GS</sub> = V <sub>DS</sub> , I <sub>D</sub> = 3mA	2.1	3	3.9	V
I <sub>GSS</sub>	Gate – Source Leakage Current	V <sub>GS</sub> = ±20 V, V <sub>DS</sub> = 0V			100	nA

**Dynamic Characteristics**

<i>Symbol</i>	<i>Characteristic</i>	<i>Test Conditions</i>	<i>Min</i>	<i>Typ</i>	<i>Max</i>	<i>Unit</i>
C <sub>iss</sub>	Input Capacitance	V <sub>GS</sub> = 0V ; V <sub>DS</sub> = 25V f = 1MHz		7.2		nF
C <sub>oss</sub>	Output Capacitance			8.5		
Q <sub>g</sub>	Total gate Charge	V <sub>GS</sub> = 10V V <sub>Bus</sub> = 300V I <sub>D</sub> = 49A		150		nC
Q <sub>gs</sub>	Gate – Source Charge			34		
Q <sub>gd</sub>	Gate – Drain Charge			51		
T <sub>d(on)</sub>	Turn-on Delay Time	<b>Inductive Switching (125°C)</b> V <sub>GS</sub> = 10V V <sub>Bus</sub> = 400V I <sub>D</sub> = 49A R <sub>G</sub> = 5Ω		21		ns
T <sub>r</sub>	Rise Time			30		
T <sub>d(off)</sub>	Turn-off Delay Time			100		
T <sub>f</sub>	Fall Time			45		
E <sub>on</sub>	Turn-on Switching Energy	<b>Inductive switching @ 25°C</b> V <sub>GS</sub> = 10V ; V <sub>Bus</sub> = 400V I <sub>D</sub> = 49A ; R <sub>G</sub> = 5Ω		675		μJ
E <sub>off</sub>	Turn-off Switching Energy			520		
E <sub>on</sub>	Turn-on Switching Energy	<b>Inductive switching @ 125°C</b> V <sub>GS</sub> = 10V ; V <sub>Bus</sub> = 400V I <sub>D</sub> = 49A ; R <sub>G</sub> = 5Ω		1096		μJ
E <sub>off</sub>	Turn-off Switching Energy			635		
R <sub>thJC</sub>	Junction to Case Thermal resistance				0.5	°C/W

**Source - Drain diode ratings and characteristics**

Symbol	Characteristic	Test Conditions	Min	Typ	Max	Unit
I <sub>S</sub>	Continuous Source current (Body diode)		T <sub>c</sub> = 25°C		49	A
			T <sub>c</sub> = 80°C		38	
V <sub>SD</sub>	Diode Forward Voltage	V <sub>GS</sub> = 0V, I <sub>S</sub> = - 49A			1.2	V
dv/dt	Peak Diode Recovery ❶				4	V/ns
t <sub>rr</sub>	Reverse Recovery Time	I <sub>S</sub> = - 49A V <sub>R</sub> = 350V di <sub>S</sub> /dt = 100A/μs	T <sub>j</sub> = 25°C		600	ns
Q <sub>rr</sub>	Reverse Recovery Charge		T <sub>j</sub> = 25°C		17	μC

❶ dv/dt numbers reflect the limitations of the circuit rather than the device itself.  
 I<sub>S</sub> ≤ - 49A    di/dt ≤ 100A/μs    V<sub>R</sub> ≤ V<sub>DSS</sub>    T<sub>j</sub> ≤ 150°C

**2.2 Chopper diode characteristics (CR5)**

Symbol	Characteristic	Test Conditions	Min	Typ	Max	Unit
V <sub>RRM</sub>	Maximum Peak Repetitive Reverse Voltage		600			V
I <sub>RM</sub>	Maximum Reverse Leakage Current	V <sub>R</sub> = 600V	T <sub>j</sub> = 25°C		25	μA
			T <sub>j</sub> = 125°C		500	
I <sub>F</sub>	DC Forward Current			30		A
V <sub>F</sub>	Diode Forward Voltage	I <sub>F</sub> = 30A		1.8	2.2	V
		I <sub>F</sub> = 60A		2.2		
		I <sub>F</sub> = 30A	T <sub>j</sub> = 125°C	1.5		
t <sub>rr</sub>	Reverse Recovery Time	I <sub>F</sub> = 30A V <sub>R</sub> = 400V di/dt = 200A/μs	T <sub>j</sub> = 25°C		25	ns
			T <sub>j</sub> = 125°C		160	
Q <sub>rr</sub>	Reverse Recovery Charge		T <sub>j</sub> = 25°C		35	nC
			T <sub>j</sub> = 125°C		480	
R <sub>thJC</sub>	Junction to Case Thermal resistance				1.2	°C/W

**3. By pass diode (CR6)**
**Absolute maximum ratings**

Symbol	Parameter	Max ratings	Unit
V <sub>R</sub>	Maximum DC reverse Voltage	1600	V
V <sub>RRM</sub>	Maximum Peak Repetitive Reverse Voltage		
I <sub>F</sub>	DC Forward Current	T <sub>C</sub> = 80°C	40
I <sub>FSM</sub>	Non-Repetitive Forward Surge Current	t = 10ms T <sub>J</sub> = 45°C	400

**Electrical Characteristics**

Symbol	Characteristic	Test Conditions	Min	Typ	Max	Unit
I <sub>R</sub>	Reverse Current	V <sub>R</sub> = 1600V	T <sub>j</sub> = 25°C		20	μA
			T <sub>j</sub> = 125°C		2	mA
V <sub>F</sub>	Forward Voltage	I <sub>F</sub> = 40A	T <sub>j</sub> = 25°C		1.3	V
			T <sub>j</sub> = 125°C		1.1	
V <sub>T</sub>	On – state Voltage			0.8		V
r <sub>T</sub>	On – state Slope resistance			10.5		mΩ
R <sub>thJC</sub>	Junction to Case Thermal resistance				1.5	°C/W

#### 4. Temperature sensor

Temperature sensor NTC (see application note APT0406 on www.microsemi.com for more information).

Symbol	Characteristic	Min	Typ	Max	Unit
R <sub>25</sub>	Resistance @ 25°C		50		kΩ
ΔR <sub>25</sub> /R <sub>25</sub>			5		%
B <sub>25/85</sub>	T <sub>25</sub> = 298.15 K		3952		K
ΔB/B			4		%

$$R_T = \frac{R_{25}}{\exp \left[ B_{25/85} \left( \frac{1}{T_{25}} - \frac{1}{T} \right) \right]}$$

T: Thermistor temperature  
 R<sub>T</sub>: Thermistor value at T

#### 5. Package characteristics

Symbol	Characteristic	Min	Typ	Max	Unit	
V <sub>ISOL</sub>	RMS Isolation Voltage, any terminal to case t=1 min, 50/60Hz	4000			V	
T <sub>J</sub>	Operating junction temperature range	-40		150	°C	
T <sub>STG</sub>	Storage Temperature Range	-40		125		
T <sub>C</sub>	Operating Case Temperature	-40		100		
Torque	Mounting torque	To heatsink	M4	2	3	N.m
Wt	Package Weight				110	g

#### 6. SP3F Package outline (dimensions in mm)

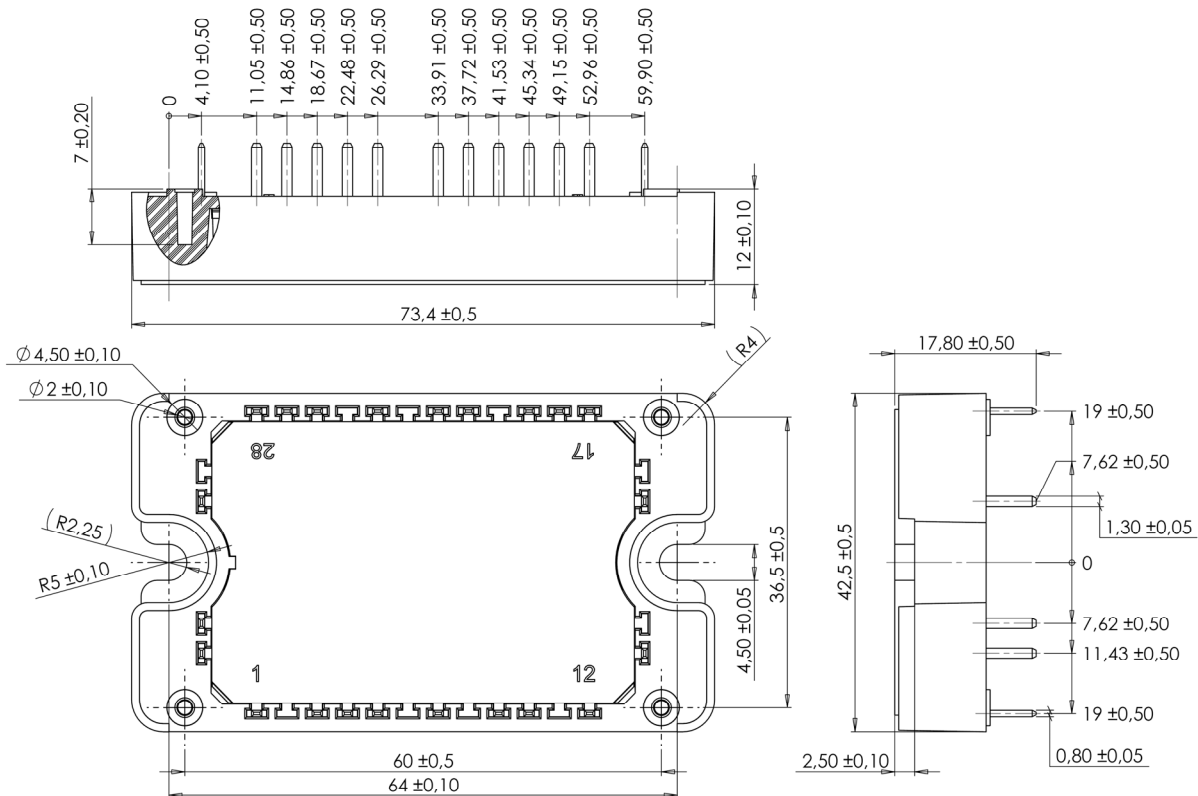

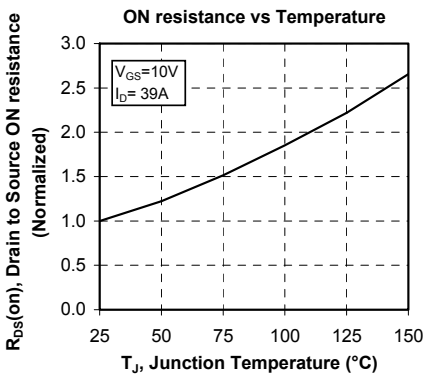
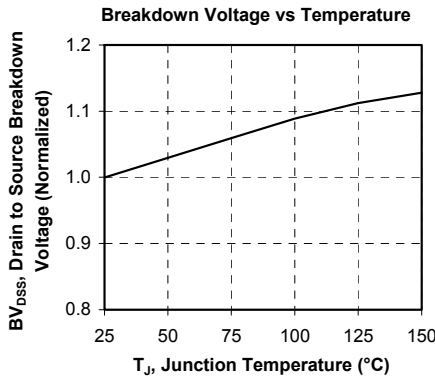
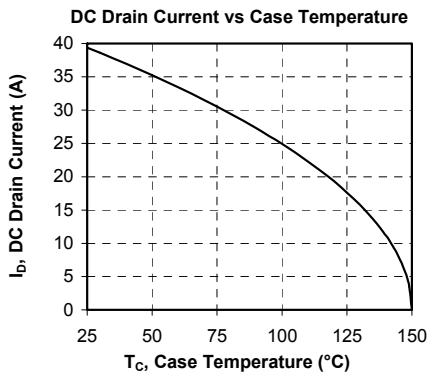
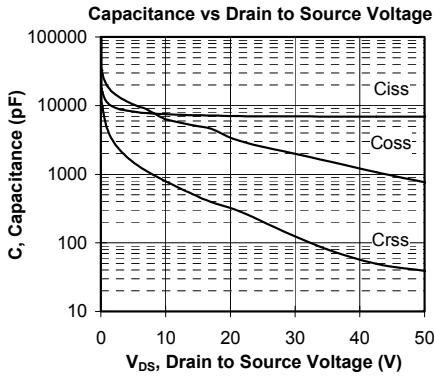
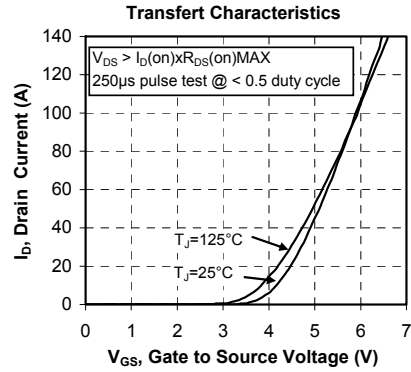
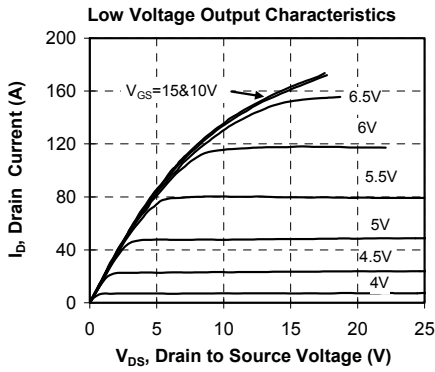
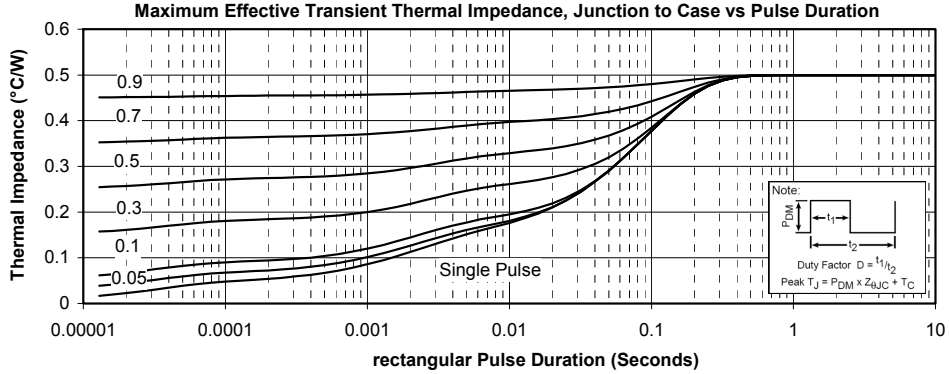
**7. Full bridge switches curves (Per CoolMOS™)**

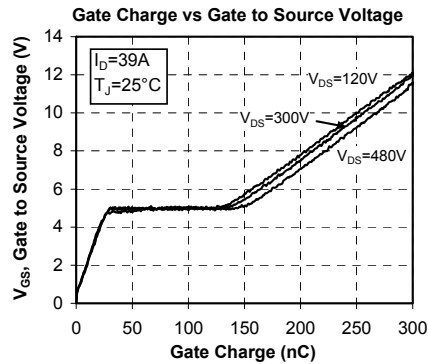
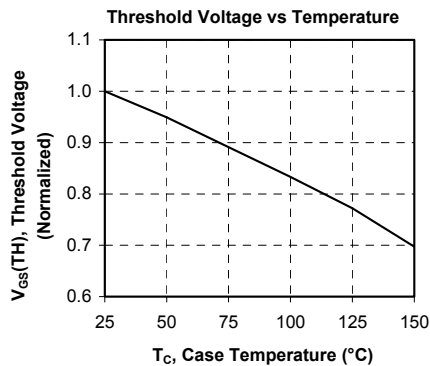
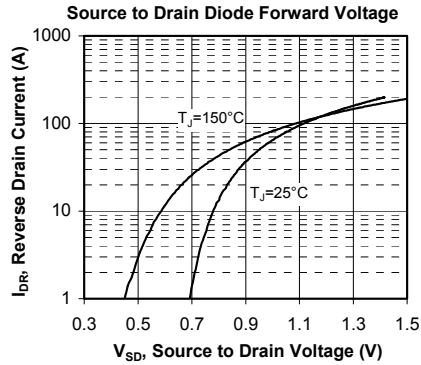
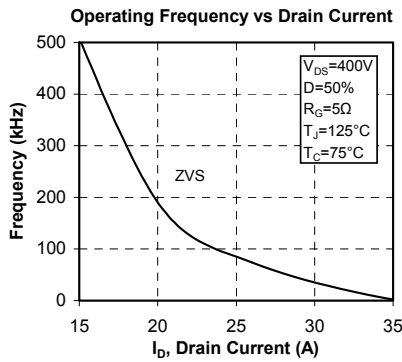
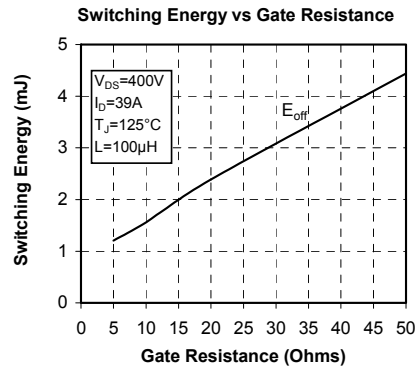
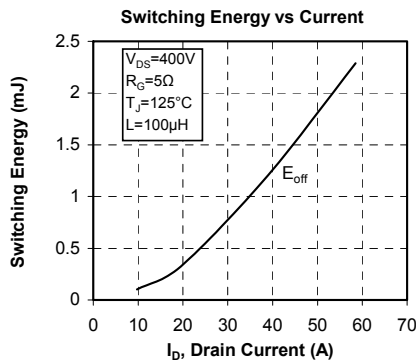
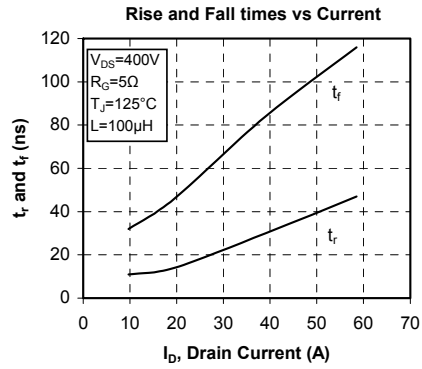
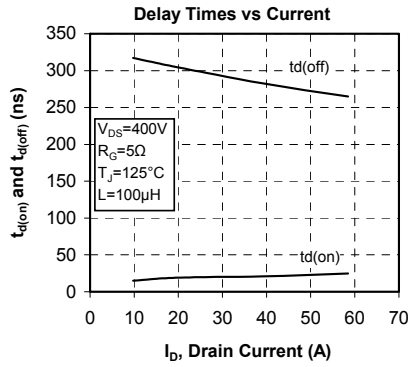

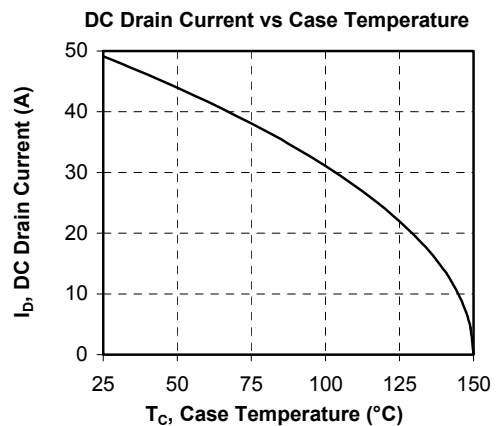
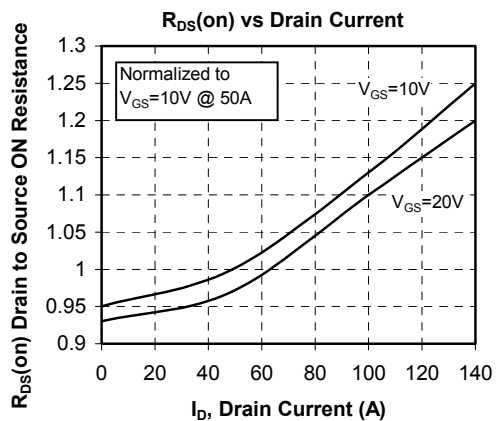
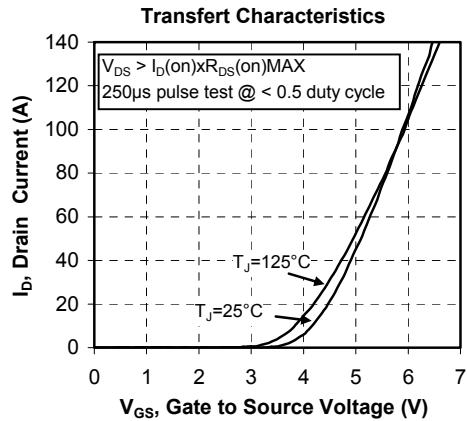
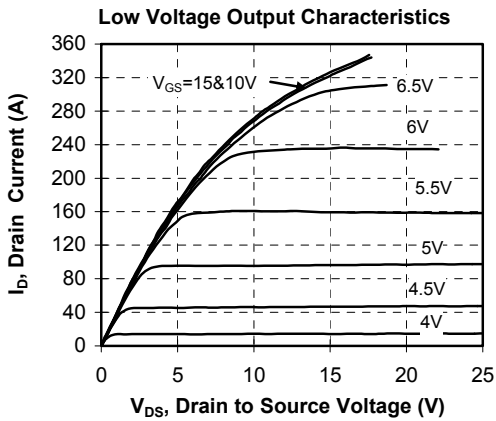
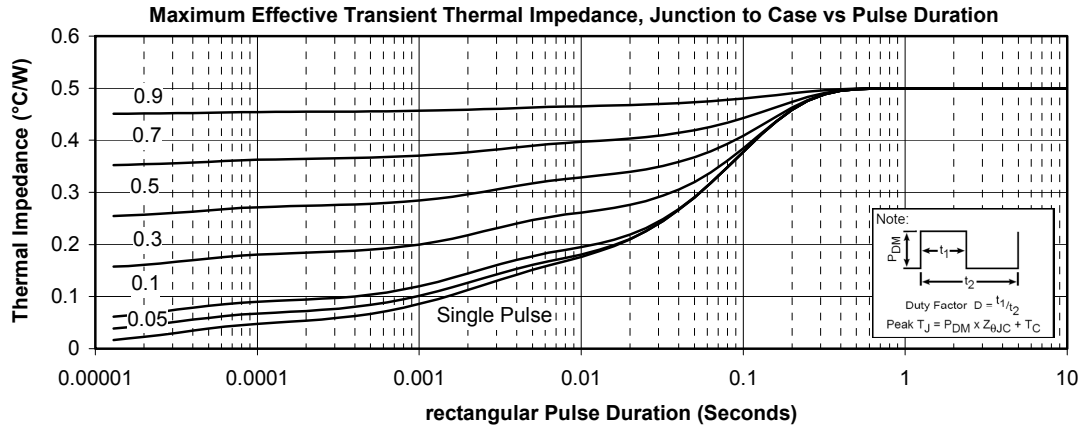
**8. Chopper CoolMOS™**



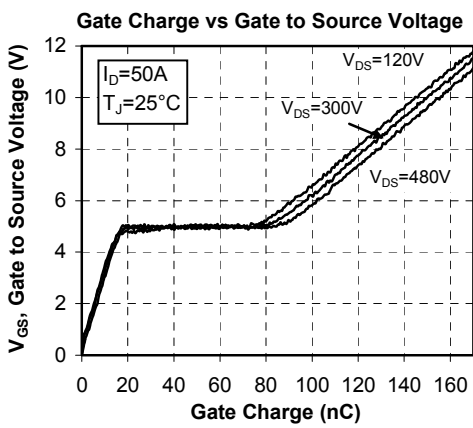
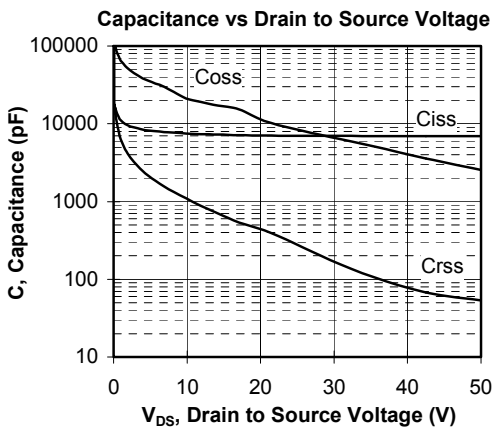
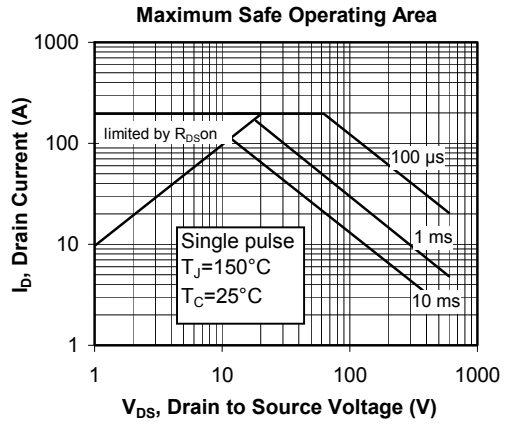
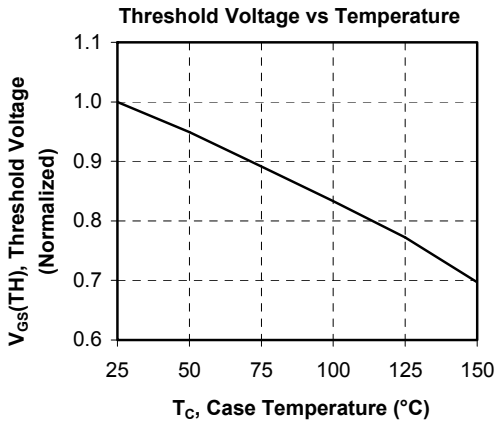
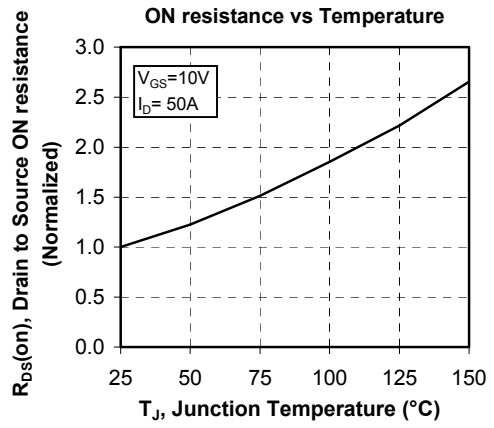
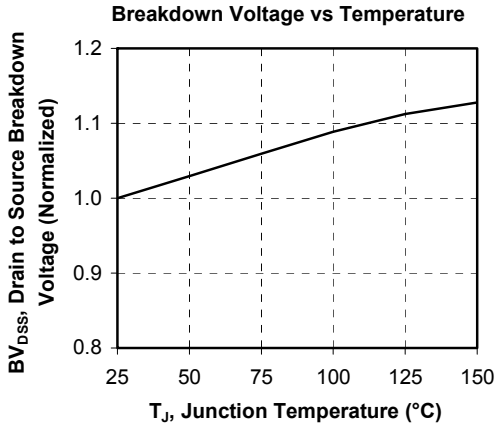

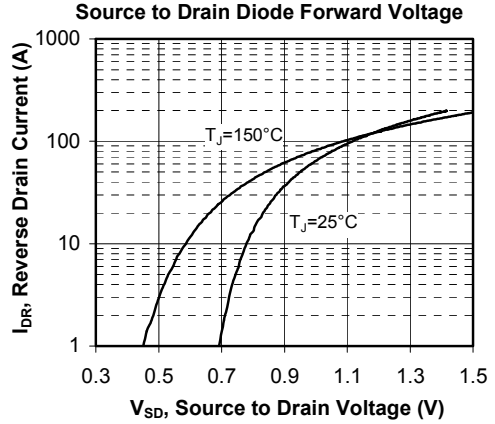
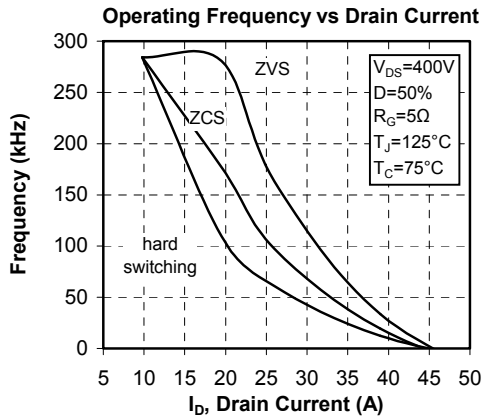
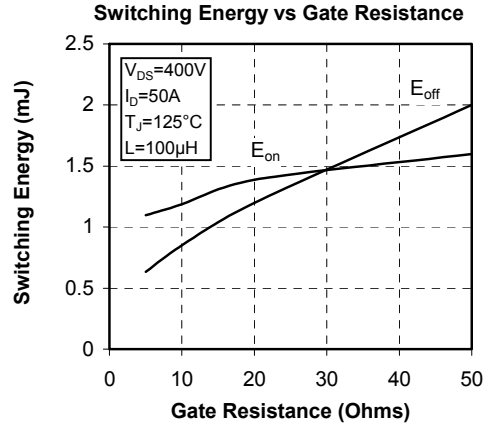
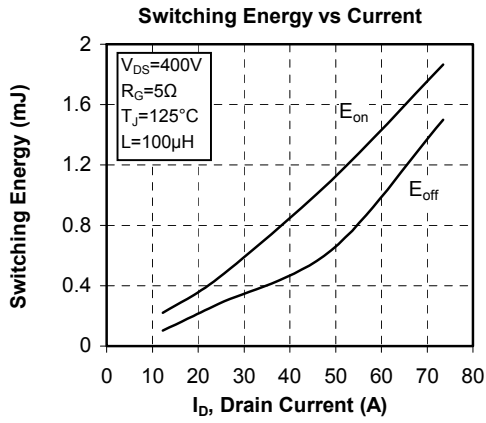
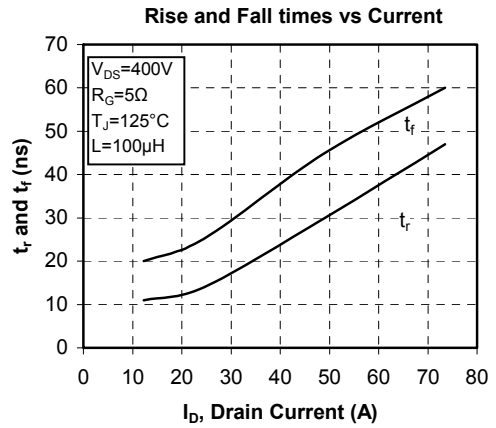
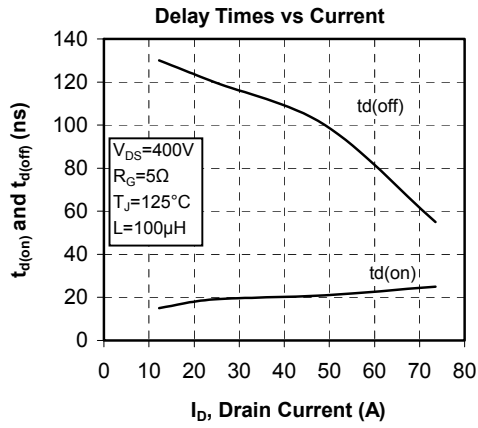

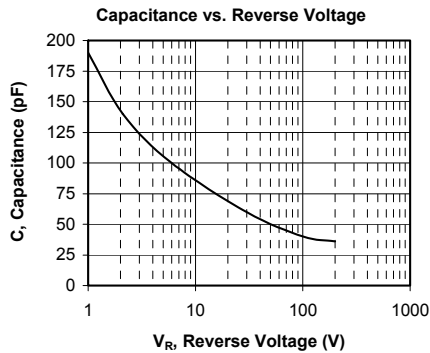
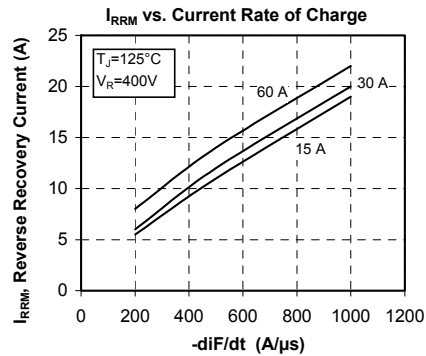
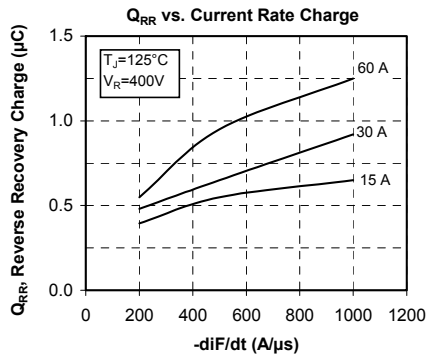
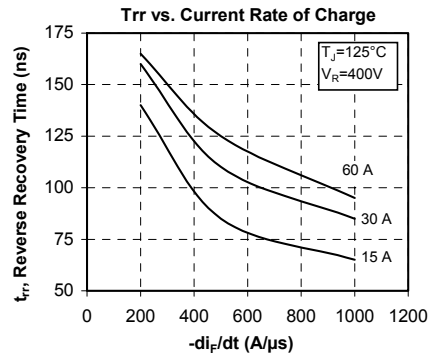
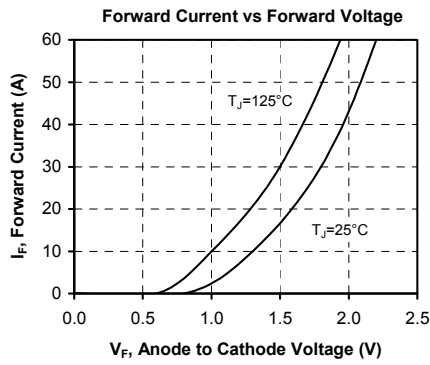
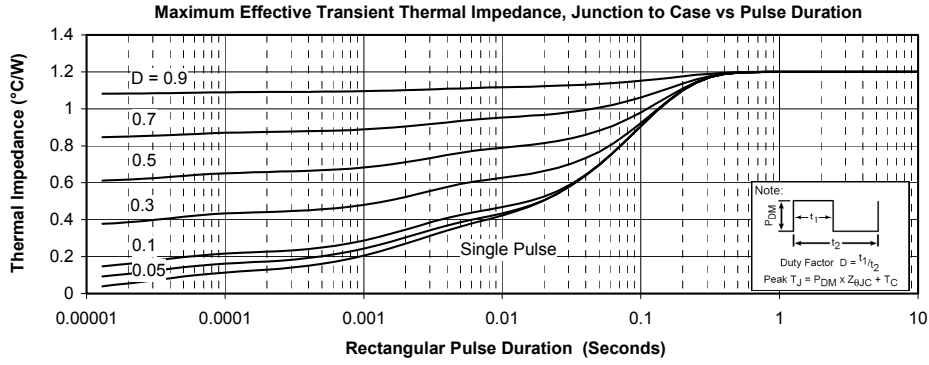
**9. Chopper diode curves**

**10. Typical by pass CR6 diode curves**

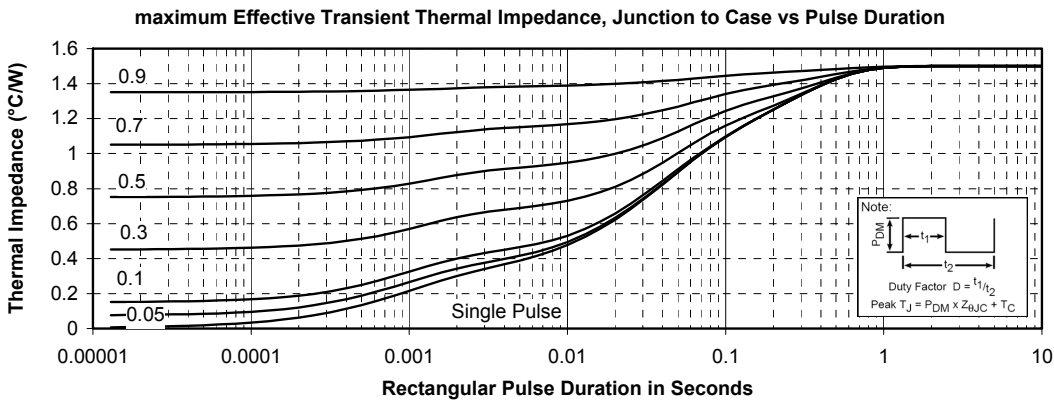
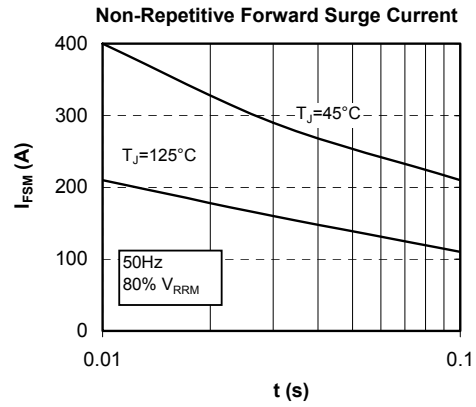
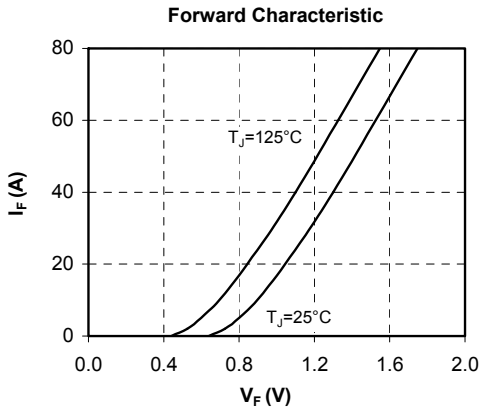

“COOLMOS™” comprise a new family of transistors developed by Infineon Technologies AG. “COOLMOS” is a trademark of Infineon Technologies AG”.

DISCLAIMER

The information contained in the document (unless it is publicly available on the Web without access restrictions) is PROPRIETARY AND CONFIDENTIAL information of Microsemi and cannot be copied, published, uploaded, posted, transmitted, distributed or disclosed or used without the express duly signed written consent of Microsemi. If the recipient of this document has entered into a disclosure agreement with Microsemi, then the terms of such Agreement will also apply. This document and the information contained herein may not be modified, by any person other than authorized personnel of Microsemi. No license under any patent, copyright, trade secret or other intellectual property right is granted to or conferred upon you by disclosure or delivery of the information, either expressly, by implication, inducement, estoppels or otherwise. Any license under such intellectual property rights must be approved by Microsemi in writing signed by an officer of Microsemi.

Microsemi reserves the right to change the configuration, functionality and performance of its products at anytime without any notice. This product has been subject to limited testing and should not be used in conjunction with life-support or other mission-critical equipment or applications. Microsemi assumes no liability whatsoever, and Microsemi disclaims any express or implied warranty, relating to sale and/or use of Microsemi products including liability or warranties relating to fitness for a particular purpose, merchantability, or infringement of any patent, copyright or other intellectual property right. Any performance specifications believed to be reliable but are not verified and customer or user must conduct and complete all performance and other testing of this product as well as any user or customers final application. User or customer shall not rely on any data and performance specifications or parameters provided by Microsemi. It is the customer's and user's responsibility to independently determine suitability of any Microsemi product and to test and verify the same. The information contained herein is provided "AS IS, WHERE IS" and with all faults, and the entire risk associated with such information is entirely with the User. Microsemi specifically disclaims any liability of any kind including for consequential, incidental and punitive damages as well as lost profit. The product is subject to other terms and conditions which can be located on the web at <http://www.microsemi.com/legal/tnc.asp>

Life Support Application

Seller's Products are not designed, intended, or authorized for use as components in systems intended for space, aviation, surgical implant into the body, in other applications intended to support or sustain life, or for any other application in which the failure of the Seller's Product could create a situation where personal injury, death or property damage or loss may occur (collectively "Life Support Applications").

Buyer agrees not to use Products in any Life Support Applications and to the extent it does it shall conduct extensive testing of the Product in such applications and further agrees to indemnify and hold Seller, and its officers, employees, subsidiaries, affiliates, agents, sales representatives and distributors harmless against all claims, costs, damages and expenses, and attorneys' fees and costs arising, directly or indirectly, out of any claims of personal injury, death, damage or otherwise associated with the use of the goods in Life Support Applications, even if such claim includes allegations that Seller was negligent regarding the design or manufacture of the goods.

Buyer must notify Seller in writing before using Seller's Products in Life Support Applications. Seller will study with Buyer alternative solutions to meet Buyer application specification based on Sellers sales conditions applicable for the new proposed specific part.

## X-ON Electronics

Largest Supplier of Electrical and Electronic Components

*Click to view similar products for [Discrete Semiconductor Modules](#) category:*

*Click to view products by [Microchip](#) manufacturer:*

Other Similar products are found below :

[M252511FV](#) [M254043](#) [DD260N12K-A](#) [DD285N02K](#) [DD380N16A](#) [DDB6U144N16R](#) [DDB6U145N16L](#) [APT20M11JFLL](#)  
[APT2X101DL40J](#) [APT2X21DC60J](#) [APT2X30D40J](#) [APT2X30D60J](#) [APT2X31DQ120J](#) [APT39M60J](#) [APT47M60J](#) [APT50DF170HJ](#)  
[APT50M50JLL](#) [APT50M75JLLU3](#) [APT58M80J](#) [APT80F60J](#) [DZ540N26K](#) [B522F-2-YEC](#) [MSTC90-16](#) [MT16HTF12864AZ-800G1](#)  
[MT18HTF12872PZ-667G1](#) [MT18HTF25672FDZ-667H1D6](#) [MT18HTF25672PZ-80EH1](#) [MT18RTF25672FDZ-667H1D6](#)  
[MT36HTF51272FZ-667H1D4](#) [MT36HTF51272FZ-667H1D6](#) [MT8HTF12864HTZ-667H1](#) [MT9HTF6472PZ-667G1](#) [MT9HVF12872PZ-](#)  
[80EH1](#) [MT9HVF6472PZ-667G1](#) [ND104N16K](#) [25.163.0653.1](#) [25.163.2453.0](#) [25.163.4253.0](#) [25.190.2053.0](#) [25.194.3453.0](#) [25.320.4853.1](#)  
[25.320.5253.1](#) [25.325.3653.1](#) [25.326.3253.1](#) [25.326.3553.1](#) [25.330.1653.1](#) [25.330.4753.1](#) [25.330.5253.1](#) [25.334.3253.1](#) [25.334.3353.1](#)