

CAP1133

3 Channel Capacitive Touch Sensor with 3 LED Drivers



PRODUCT FEATURES

Datasheet

General Description

The CAP1133, which incorporates SMSC's RightTouch[®] 1 technology, is a multiple channel Capacitive Touch sensor with multiple power LED drivers. It contains three (3) individual capacitive touch sensor inputs with programmable sensitivity for use in touch sensor applications. Each sensor input automatically recalibrates to compensate for gradual environmental changes.

The CAP1133 also contains three (3) LED drivers that offer full-on / off, variable rate blinking, dimness controls, and breathing. Each of the LED drivers may be linked to one of the sensor inputs to be actuated when a touch is detected. As well, each LED driver may be individually controlled via a host controller.

The CAP1133 includes Multiple Pattern Touch recognition that allows the user to select a specific set of buttons to be touched simultaneously. If this pattern is detected, then a status bit is set and an interrupt generated.

Additionally, the CAP1133 includes circuitry and support for enhanced sensor proximity detection.

The CAP1133 offers multiple power states operating at low quiescent currents. In the Standby state of operation, one or more capacitive touch sensor inputs are active and all LEDs may be used.

Deep Sleep is the lowest power state available, drawing 5uA (typical) of current. In this state, no sensor inputs are active. Communications will wake the device.

Applications

- Desktop and Notebook PCs
- LCD Monitors
- Consumer Electronics
- Appliances

Features

- Three (3) Capacitive Touch Sensor Inputs
 - Programmable sensitivity
 - Automatic recalibration
 - Individual thresholds for each button
- Proximity Detection
- Multiple Button Pattern Detection
- Calibrates for Parasitic Capacitance
- Analog Filtering for System Noise Sources
- Press and Hold feature for Volume-like Applications
- SMBus / I²C Compliant Communication Interface
- Low Power Operation
 - 5uA quiescent current in Deep Sleep
 - 50uA quiescent current in Standby (1 sensor input monitored)
 - Samples one or more channels in Standby
- Three (3) LED Driver Outputs
 - Open Drain or Push-Pull
 - Programmable blink, breathe, and dimness controls
 - Can be linked to Capacitive Touch Sensor inputs
- Available in 10-pin 3mm x 3mm RoHS compliant DFN package

1. SMSC, the SMSC logo and RightTouch are registered trademarks and the RightTouch logo is a trademark of Standard Microsystems Corporation ("SMSC").

Block Diagram

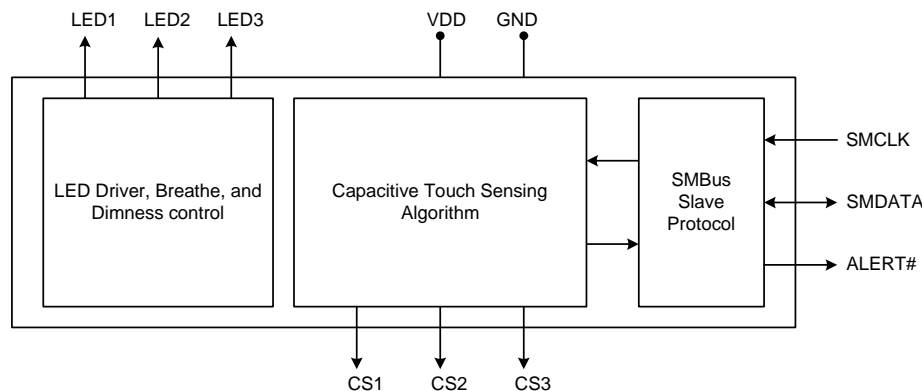

Datasheet

Ordering Information:

ORDERING NUMBER	PACKAGE	FEATURES
CAP1133-1-AIA-TR	10-pin DFN 3mm x 3mm (Lead-free RoHS compliant)	Three capacitive touch sensor inputs, Three LED drivers, SMBus interface

Reel size is 4,000 pieces

This product meets the halogen maximum concentration values per IEC61249-2-21

For RoHS compliance and environmental information, please visit www.smisc.com/rohs

Please contact your SMSC sales representative for additional documentation related to this product such as application notes, anomaly sheets, and design guidelines.

Copyright © 2012 SMSC or its subsidiaries. All rights reserved.

Circuit diagrams and other information relating to SMSC products are included as a means of illustrating typical applications. Consequently, complete information sufficient for construction purposes is not necessarily given. Although the information has been checked and is believed to be accurate, no responsibility is assumed for inaccuracies. SMSC reserves the right to make changes to specifications and product descriptions at any time without notice. Contact your local SMSC sales office to obtain the latest specifications before placing your product order. The provision of this information does not convey to the purchaser of the described semiconductor devices any licenses under any patent rights or other intellectual property rights of SMSC or others. All sales are expressly conditional on your agreement to the terms and conditions of the most recently dated version of SMSC's standard Terms of Sale Agreement dated before the date of your order (the "Terms of Sale Agreement"). The product may contain design defects or errors known as anomalies which may cause the product's functions to deviate from published specifications. Anomaly sheets are available upon request. SMSC products are not designed, intended, authorized or warranted for use in any life support or other application where product failure could cause or contribute to personal injury or severe property damage. Any and all such uses without prior written approval of an Officer of SMSC and further testing and/or modification will be fully at the risk of the customer. Copies of this document or other SMSC literature, as well as the Terms of Sale Agreement, may be obtained by visiting SMSC's website at <http://www.smisc.com>. SMSC is a registered trademark of Standard Microsystems Corporation ("SMSC"). Product names and company names are the trademarks of their respective holders.

The Microchip name and logo, and the Microchip logo are registered trademarks of Microchip Technology Incorporated in the U.S.A. and other countries.

SMSC DISCLAIMS AND EXCLUDES ANY AND ALL WARRANTIES, INCLUDING WITHOUT LIMITATION ANY AND ALL IMPLIED WARRANTIES OF MERCHANTABILITY, FITNESS FOR A PARTICULAR PURPOSE, TITLE, AND AGAINST INFRINGEMENT AND THE LIKE, AND ANY AND ALL WARRANTIES ARISING FROM ANY COURSE OF DEALING OR USAGE OF TRADE. IN NO EVENT SHALL SMSC BE LIABLE FOR ANY DIRECT, INCIDENTAL, INDIRECT, SPECIAL, PUNITIVE, OR CONSEQUENTIAL DAMAGES; OR FOR LOST DATA, PROFITS, SAVINGS OR REVENUES OF ANY KIND; REGARDLESS OF THE FORM OF ACTION, WHETHER BASED ON CONTRACT; TORT; NEGLIGENCE OF SMSC OR OTHERS; STRICT LIABILITY; BREACH OF WARRANTY; OR OTHERWISE; WHETHER OR NOT ANY REMEDY OF BUYER IS HELD TO HAVE FAILED OF ITS ESSENTIAL PURPOSE, AND WHETHER OR NOT SMSC HAS BEEN ADVISED OF THE POSSIBILITY OF SUCH DAMAGES.

Table of Contents

Chapter 1	Pin Description	8
Chapter 2	Electrical Specifications	10
Chapter 3	Communications	14
3.1	Communications	14
3.2	System Management Bus	14
3.2.1	SMBus Start Bit	14
3.2.2	SMBus Address and RD / $\overline{\text{WR}}$ Bit	14
3.2.3	SMBus Data Bytes	14
3.2.4	SMBus ACK and NACK Bits	15
3.2.5	SMBus Stop Bit	15
3.2.6	SMBus Timeout	15
3.2.7	SMBus and I ² C Compatibility	15
3.3	SMBus Protocols	15
3.3.1	SMBus Write Byte	16
3.3.2	SMBus Read Byte	16
3.3.3	SMBus Send Byte	16
3.3.4	SMBus Receive Byte	16
3.4	I ² C Protocols	17
3.4.1	Block Write	17
3.4.2	Block Read	17
Chapter 4	General Description	18
4.1	Power States	19
4.2	LED Drivers	19
4.2.1	Linking LEDs to Capacitive Touch Sensor Inputs	19
4.3	Capacitive Touch Sensing	19
4.3.1	Sensing Cycle	20
4.3.2	Recalibrating Sensor Inputs	20
4.3.3	Proximity Detection	21
4.3.4	Multiple Touch Pattern Detection	21
4.3.5	Low Frequency Noise Detection	21
4.3.6	RF Noise Detection	21
4.4	ALERT# Pin	21
4.4.1	Sensor Interrupt Behavior	21
Chapter 5	Register Description	23
5.1	Main Control Register	26
5.2	Status Registers	27
5.2.1	General Status - 02h	27
5.2.2	Sensor Input Status - 03h	27
5.2.3	LED Status - 04h	28
5.3	Noise Flag Status Registers	28
5.4	Sensor Input Delta Count Registers	29
5.5	Sensitivity Control Register	29
5.6	Configuration Registers	31
5.6.1	Configuration - 20h	31
5.6.2	Configuration 2 - 44h	31
5.7	Sensor Input Enable Registers	32

Datasheet

5.8	Sensor Input Configuration Register	33
5.9	Sensor Input Configuration 2 Register	35
5.10	Averaging and Sampling Configuration Register	36
5.11	Calibration Activate Register	37
5.12	Interrupt Enable Register	38
5.13	Repeat Rate Enable Register	38
5.14	Multiple Touch Configuration Register	39
5.15	Multiple Touch Pattern Configuration Register	39
5.16	Multiple Touch Pattern Register	41
5.17	Recalibration Configuration Register	41
5.18	Sensor Input Threshold Registers	43
5.19	Sensor Input Noise Threshold Register	43
5.20	Standby Channel Register	44
5.21	Standby Configuration Register	44
5.22	Standby Sensitivity Register	46
5.23	Standby Threshold Register	47
5.24	Sensor Input Base Count Registers	47
5.25	LED Output Type Register	48
5.26	Sensor Input LED Linking Register	48
5.27	LED Polarity Register	49
5.28	LED Output Control Register	50
5.29	Linked LED Transition Control Register	51
5.30	LED Mirror Control Register	52
5.31	LED Behavior Register	52
5.32	LED Pulse 1 Period Register	54
5.33	LED Pulse 2 Period Register	56
5.34	LED Breathe Period Register	57
5.35	LED Configuration Register	57
5.36	LED Duty Cycle Registers	58
5.37	LED Direct Ramp Rates Register	59
5.38	LED Off Delay Register	60
5.39	Sensor Input Calibration Registers	64
5.40	Product ID Register	64
5.41	Manufacturer ID Register	64
5.42	Revision Register	64
<hr/>		
Chapter 6	Package Information	65
6.1	CAP1133 Package Drawings	65
6.2	Package Marking	67
<hr/>		
Appendix A	Device Delta	68
A.1	Delta from CAP1033 to CAP1133	68
<hr/>		
Chapter 7	Datasheet Revision History	70

List of Figures

Figure 1.1	CAP1133 Pin Diagram (10-Pin DFN)	8
Figure 3.1	SMBus Timing Diagram	14
Figure 4.1	System Diagram for CAP1133	18
Figure 4.2	Sensor Interrupt Behavior - Repeat Rate Enabled	22
Figure 4.3	Sensor Interrupt Behavior - No Repeat Rate Enabled	22
Figure 5.1	Pulse 1 Behavior with Non-Inverted Polarity	55
Figure 5.2	Pulse 1 Behavior with Inverted Polarity	55
Figure 5.3	Pulse 2 Behavior with Non-Inverted Polarity	56
Figure 5.4	Pulse 2 Behavior with Inverted Polarity	57
Figure 5.5	Breathe Behavior with Non-Inverted Polarity	61
Figure 5.6	Breathe Behavior with Inverted Polarity	61
Figure 5.7	Direct Behavior for Non-Inverted Polarity	62
Figure 5.8	Direct Behavior for Inverted Polarity	63
Figure 6.1	10-Pin DFN 3mm x 3mm Package Drawings	65
Figure 6.2	10-Pin DFN 3mm x 3mm Package Dimensions	66
Figure 6.3	10-Pin DFN 3mm x 3mm PCB Footprint	66
Figure 6.4	CAP1133 Package Marking	67

List of Tables

Table 1.1	Pin Description for CAP1133	8
Table 1.2	Pin Types	9
Table 2.1	Absolute Maximum Ratings	10
Table 2.2	Electrical Specifications	10
Table 3.1	Protocol Format	16
Table 3.2	Write Byte Protocol	16
Table 3.3	Read Byte Protocol	16
Table 3.4	Send Byte Protocol	16
Table 3.5	Receive Byte Protocol	17
Table 3.6	Block Write Protocol	17
Table 3.7	Block Read Protocol	17
Table 5.1	Register Set in Hexadecimal Order	23
Table 5.2	Main Control Register	26
Table 5.3	GAIN Bit Decode	26
Table 5.4	Status Registers	27
Table 5.5	Noise Flag Status Registers	28
Table 5.6	Sensor Input Delta Count Registers	29
Table 5.7	Sensitivity Control Register	29
Table 5.8	DELTA_SENSE Bit Decode	30
Table 5.9	BASE_SHIFT Bit Decode	30
Table 5.10	Configuration Registers	31
Table 5.11	Sensor Input Enable Registers	32
Table 5.12	Sensor Input Configuration Register	33
Table 5.13	MAX_DUR Bit Decode	33
Table 5.14	RPT_RATE Bit Decode	34
Table 5.15	Sensor Input Configuration 2 Register	35
Table 5.16	M_PRESS Bit Decode	35
Table 5.17	Averaging and Sampling Configuration Register	36
Table 5.18	AVG Bit Decode	36
Table 5.19	SAMP_TIME Bit Decode	36
Table 5.20	CYCLE_TIME Bit Decode	37
Table 5.21	Calibration Activate Register	37
Table 5.22	Interrupt Enable Register	38
Table 5.23	Repeat Rate Enable Register	38
Table 5.24	Multiple Touch Configuration	39
Table 5.25	B_MULT_T Bit Decode	39
Table 5.26	Multiple Touch Pattern Configuration	39
Table 5.27	MTP_TH Bit Decode	40
Table 5.28	Multiple Touch Pattern Register	41
Table 5.29	Recalibration Configuration Registers	41
Table 5.30	NEG_DELTA_CNT Bit Decode	42
Table 5.31	CAL_CFG Bit Decode	42
Table 5.32	Sensor Input Threshold Registers	43
Table 5.33	Sensor Input Noise Threshold Register	43
Table 5.34	CSx_BN_TH Bit Decode	44
Table 5.35	Standby Channel Register	44
Table 5.36	Standby Configuration Register	44
Table 5.37	STBY_AVG Bit Decode	45
Table 5.38	STBY_SAMP_TIME Bit Decode	45
Table 5.39	STBY_CY_TIME Bit Decode	46
Table 5.40	Standby Sensitivity Register	46
Table 5.41	STBY_SENSE Bit Decode	46

Table 5.42	Standby Threshold Register	47
Table 5.43	Sensor Input Base Count Registers	47
Table 5.44	LED Output Type Register	48
Table 5.45	Sensor Input LED Linking Register	48
Table 5.46	LED Polarity Register	49
Table 5.47	LED Output Control Register	50
Table 5.48	LED Polarity Behavior	50
Table 5.49	Linked LED Transition Control Register	51
Table 5.50	LED Mirror Control Register	52
Table 5.51	LED Behavior Register	52
Table 5.52	LEDx_CTL Bit Decode	53
Table 5.53	LED Pulse 1 Period Register	54
Table 5.54	LED Pulse / Breathe Period Example	55
Table 5.55	LED Pulse 2 Period Register	56
Table 5.56	LED Breathe Period Register	57
Table 5.57	LED Configuration Register	57
Table 5.58	PULSEX_CNT Decode	58
Table 5.59	LED Duty Cycle Registers	58
Table 5.60	LED Duty Cycle Decode	59
Table 5.61	LED Direct Ramp Rates Register	59
Table 5.62	Rise / Fall Rate Decode	60
Table 5.63	LED Off Delay Register	60
Table 5.64	Breathe Off Delay Settings	62
Table 5.65	Off Delay Decode	63
Table 5.66	Sensor Input Calibration Registers	64
Table 5.67	Product ID Register	64
Table 5.68	Vendor ID Register	64
Table 5.69	Revision Register	64
Table A.1	Register Delta From CAP1033 to CAP1133	68
Table 7.1	Customer Revision History	70

Table 1.1 Pin Description for CAP1133 (continued)

PIN NUMBER	PIN NAME	PIN FUNCTION	PIN TYPE	UNUSED CONNECTION
7	LED3	Open drain LED 3 driver (default)	OD (5V)	Connect to Ground
		Push-pull LED 3 driver	DO	leave open or connect to Ground
8	CS3	Capacitive Touch Sensor Input 3	AIO	Connect to Ground
9	CS2	Capacitive Touch Sensor Input 2	AIO	Connect to Ground
10	CS1	Capacitive Touch Sensor Input 1	AIO	Connect to Ground
Bottom Pad	GND	Ground	Power	n/a

APPLICATION NOTE: When the ALERT# pin is configured as an active low output, it will be open drain. When it is configured as an active high output, it will be push-pull.

APPLICATION NOTE: For the 5V tolerant pins that have a pull-up resistor, the pull-up voltage must not exceed 3.6V when the CAP1133 is unpowered.

The pin types are described in [Table 1.2](#). All pins labeled with (5V) are 5V tolerant.

Table 1.2 Pin Types

PIN TYPE	DESCRIPTION
Power	This pin is used to supply power or ground to the device.
DI	Digital Input - This pin is used as a digital input. This pin is 5V tolerant.
AIO	Analog Input / Output -This pin is used as an I/O for analog signals.
DIOD	Digital Input / Open Drain Output - This pin is used as a digital I/O. When it is used as an output, it is open drain and requires a pull-up resistor. This pin is 5V tolerant.
OD	Open Drain Digital Output - This pin is used as a digital output. It is open drain and requires a pull-up resistor. This pin is 5V tolerant.
DO	Push-pull Digital Output - This pin is used as a digital output and can sink and source current.
DIO	Push-pull Digital Input / Output - This pin is used as an I/O for digital signals.

Chapter 2 Electrical Specifications

Table 2.1 Absolute Maximum Ratings

Voltage on 5V tolerant pins (V_{5VT_PIN})	-0.3 to 5.5	V
Voltage on 5V tolerant pins ($ V_{5VT_PIN} - V_{DD} $) Note 2.2	0 to 3.6	V
Voltage on VDD pin	-0.3 to 4	V
Voltage on any other pin to GND	-0.3 to $V_{DD} + 0.3$	V
Package Power Dissipation up to $T_A = 85^\circ\text{C}$ for 10 pin DFN (see Note 2.3)	0.7	W
Junction to Ambient (θ_{JA})	77.7	$^\circ\text{C}/\text{W}$
Operating Ambient Temperature Range	-40 to 125	$^\circ\text{C}$
Storage Temperature Range	-55 to 150	$^\circ\text{C}$
ESD Rating, All Pins, HBM	8000	V

Note 2.1 Stresses above those listed could cause permanent damage to the device. This is a stress rating only and functional operation of the device at any other condition above those indicated in the operation sections of this specification is not implied.

Note 2.2 For the 5V tolerant pins that have a pull-up resistor, the voltage difference between V_{5VT_PIN} and V_{DD} must never exceed 3.6V.

Note 2.3 The Package Power Dissipation specification assumes a recommended thermal via design consisting of a 2x2 matrix of 0.3mm (12mil) vias at 1.0mm pitch connected to the ground plane with a 1.6 x 2.3mm thermal landing.

Table 2.2 Electrical Specifications

$V_{DD} = 3\text{V to } 3.6\text{V}$, $T_A = 0^\circ\text{C to } 85^\circ\text{C}$, all Typical values at $T_A = 27^\circ\text{C}$ unless otherwise noted.						
CHARACTERISTIC	SYMBOL	MIN	TYP	MAX	UNIT	CONDITIONS
DC Power						
Supply Voltage	V_{DD}	3.0	3.3	3.6	V	

Table 2.2 Electrical Specifications (continued)

$V_{DD} = 3V$ to $3.6V$, $T_A = 0^{\circ}C$ to $85^{\circ}C$, all Typical values at $T_A = 27^{\circ}C$ unless otherwise noted.						
CHARACTERISTIC	SYMBOL	MIN	TYP	MAX	UNIT	CONDITIONS
Supply Current	I_{STBY}		120	170	μA	Standby state active 1 sensor input monitored No LEDs active Default conditions (8 avg, 70ms cycle time)
	I_{STBY}		50		μA	Standby state active 1 sensor input monitored No LEDs active 1 avg, 140ms cycle time,
	I_{DSLEEP}		5	15	μA	Deep Sleep state active LEDs at 100% or 0% Duty Cycle No communications $T_A < 40^{\circ}C$ $3.135 < V_{DD} < 3.465V$
	I_{DD}		500	600	μA	Capacitive Sensing Active No LEDs active
Capacitive Touch Sensor Inputs						
Maximum Base Capacitance	C_{BASE}		50		pF	Pad untouched
Minimum Detectable Capacitive Shift	ΔC_{TOUCH}	20			fF	Pad touched - default conditions (1 avg, 35ms cycle time, 1x sensitivity)
Recommended Cap Shift	ΔC_{TOUCH}	0.1		2	pF	Pad touched - Not tested
Power Supply Rejection	PSR		± 3	± 10	counts / V	Untouched Current Counts Base Capacitance 5pF - 50pF Maximum sensitivity Negative Delta Counts disabled All other parameters default
Timing						
Time to communications ready	t_{COMM_DLY}			15	ms	
Time to first conversion ready	t_{CONV_DLY}		170	200	ms	
LED Drivers						
Duty Cycle	$DUTY_{LED}$	0		100	%	Programmable
Drive Frequency	f_{LED}		2		kHz	
Sinking Current	I_{SINK}			24	mA	$V_{OL} = 0.4$
Sourcing Current	I_{SOURCE}			24	mA	$V_{OH} = V_{DD} - 0.4$

Datasheet

Table 2.2 Electrical Specifications (continued)

V _{DD} = 3V to 3.6V, T _A = 0°C to 85°C, all Typical values at T _A = 27°C unless otherwise noted.						
CHARACTERISTIC	SYMBOL	MIN	TYP	MAX	UNIT	CONDITIONS
Leakage Current	I _{LEAK}			±5	uA	powered or unpowered T _A < 85°C pull-up voltage ≤ 3.6V if unpowered
I/O Pins						
Output Low Voltage	V _{OL}			0.4	V	I _{SINK_IO} = 8mA
Output High Voltage	V _{OH}	V _{DD} - 0.4			V	I _{SOURCE_IO} = 8mA
Input High Voltage	V _{IH}	2.0			V	
Input Low Voltage	V _{IL}			0.8	V	
Leakage Current	I _{LEAK}			±5	uA	powered or unpowered T _A < 85°C pull-up voltage ≤ 3.6V if unpowered
SMBus Timing						
Input Capacitance	C _{IN}		5		pF	
Clock Frequency	f _{SMB}	10		400	kHz	
Spike Suppression	t _{SP}			50	ns	
Bus Free Time Stop to Start	t _{BUF}	1.3			us	
Start Setup Time	t _{SU:STA}	0.6			us	
Start Hold Time	t _{HD:STA}	0.6			us	
Stop Setup Time	t _{SU:STO}	0.6			us	
Data Hold Time	t _{HD:DAT}	0			us	When transmitting to the master
Data Hold Time	t _{HD:DAT}	0.3			us	When receiving from the master
Data Setup Time	t _{SU:DAT}	0.6			us	
Clock Low Period	t _{LOW}	1.3			us	
Clock High Period	t _{HIGH}	0.6			us	
Clock / Data Fall Time	t _{FALL}			300	ns	Min = 20+0.1C _{LOAD} ns
Clock / Data Rise Time	t _{RISE}			300	ns	Min = 20+0.1C _{LOAD} ns
Capacitive Load	C _{LOAD}			400	pF	per bus line

Note 2.4 The ALERT pin will not glitch high or low at power up if connected to VDD or another voltage.

Note 2.5 The SMCLK and SMDATA pins will not glitch low at power up if connected to VDD or another voltage.

Chapter 3 Communications

3.1 Communications

The CAP1133 communicates using the SMBus or I²C protocol.

The CAP1133 supports the following protocols: Send Byte, Receive Byte, Read Byte, Write Byte, Read Block, and Write Block. In addition, the device supports I²C formatting for block read and block write protocols.

3.2 System Management Bus

The CAP1133 communicates with a host controller, such as an SMSC SIO, through the SMBus. The SMBus is a two-wire serial communication protocol between a computer host and its peripheral devices. A detailed timing diagram is shown in Figure 3.1. Stretching of the SMCLK signal is supported; however, the CAP1133 will not stretch the clock signal.

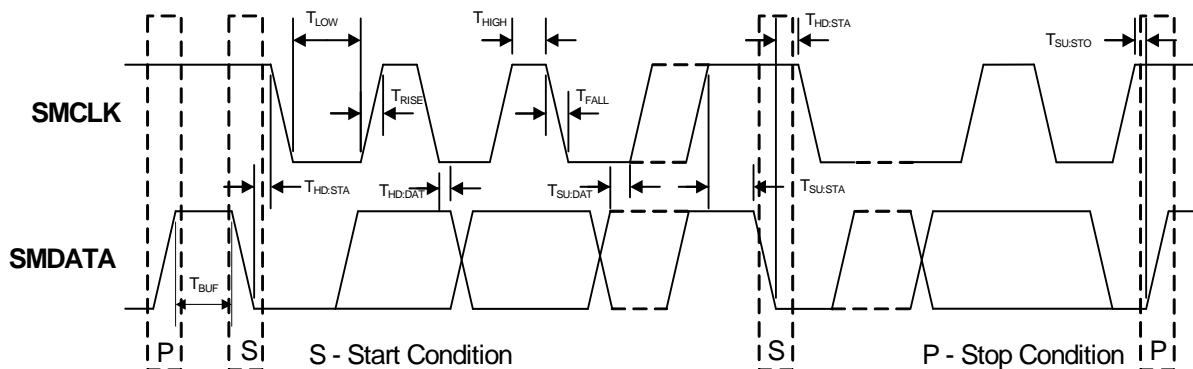

Figure 3.1 SMBus Timing Diagram

3.2.1 SMBus Start Bit

The SMBus Start bit is defined as a transition of the SMBus Data line from a logic '1' state to a logic '0' state while the SMBus Clock line is in a logic '1' state.

3.2.2 SMBus Address and RD / $\overline{\text{WR}}$ Bit

The SMBus Address Byte consists of the 7-bit client address followed by the RD / $\overline{\text{WR}}$ indicator bit. If this RD / $\overline{\text{WR}}$ bit is a logic '0', then the SMBus Host is writing data to the client device. If this RD / $\overline{\text{WR}}$ bit is a logic '1', then the SMBus Host is reading data from the client device.

The CAP1133 responds to SMBus address 0101_000(r/w).

3.2.3 SMBus Data Bytes

All SMBus Data bytes are sent most significant bit first and composed of 8-bits of information.

3.2.4 SMBus ACK and NACK Bits

The SMBus client will acknowledge all data bytes that it receives. This is done by the client device pulling the SMBus Data line low after the 8th bit of each byte that is transmitted. This applies to both the Write Byte and Block Write protocols.

The Host will NACK (not acknowledge) the last data byte to be received from the client by holding the SMBus data line high after the 8th data bit has been sent. For the Block Read protocol, the Host will ACK each data byte that it receives except the last data byte.

3.2.5 SMBus Stop Bit

The SMBus Stop bit is defined as a transition of the SMBus Data line from a logic '0' state to a logic '1' state while the SMBus clock line is in a logic '1' state. When the CAP1133 detects an SMBus Stop bit and it has been communicating with the SMBus protocol, it will reset its client interface and prepare to receive further communications.

3.2.6 SMBus Timeout

The CAP1133 includes an SMBus timeout feature. Following a 30ms period of inactivity on the SMBus where the SMCLK pin is held low, the device will timeout and reset the SMBus interface.

The timeout function defaults to disabled. It can be enabled by setting the TIMEOUT bit in the Configuration register (see [Section 5.6, "Configuration Registers"](#)).

3.2.7 SMBus and I²C Compatibility

The major differences between SMBus and I²C devices are highlighted here. For more information, refer to the SMBus 2.0 and I²C specifications. For information on using the CAP1133 in an I²C system, refer to SMSC AN 14.0 SMSC Dedicated Slave Devices in I²C Systems.

1. CAP1133 supports I²C fast mode at 400kHz. This covers the SMBus max time of 100kHz.
2. Minimum frequency for SMBus communications is 10kHz.
3. The SMBus client protocol will reset if the clock is held at a logic '0' for longer than 30ms. This timeout functionality is disabled by default in the CAP1133 and can be enabled by writing to the TIMEOUT bit. I²C does not have a timeout.
4. The SMBus client protocol will reset if both the clock and data lines are held at a logic '1' for longer than 200μs (idle condition). This function is disabled by default in the CAP1133 and can be enabled by writing to the TIMEOUT bit. I²C does not have an idle condition.
5. I²C devices do not support the Alert Response Address functionality (which is optional for SMBus).
6. I²C devices support block read and write differently. I²C protocol allows for unlimited number of bytes to be sent in either direction. The SMBus protocol requires that an additional data byte indicating number of bytes to read / write is transmitted. The CAP1133 supports I²C formatting only.

3.3 SMBus Protocols

The CAP1133 is SMBus 2.0 compatible and supports Write Byte, Read Byte, Send Byte, and Receive Byte as valid protocols as shown below.

All of the below protocols use the convention in [Table 3.1](#).

Table 3.1 Protocol Format

DATA SENT TO DEVICE	DATA SENT TO THE HOST
Data sent	Data sent

3.3.1 SMBus Write Byte

The Write Byte is used to write one byte of data to a specific register as shown in [Table 3.2](#).

Table 3.2 Write Byte Protocol

START	SLAVE ADDRESS	WR	ACK	REGISTER ADDRESS	ACK	REGISTER DATA	ACK	STOP
1 -> 0	0101_000	0	0	XXh	0	XXh	0	0 -> 1

3.3.2 SMBus Read Byte

The Read Byte protocol is used to read one byte of data from the registers as shown in [Table 3.3](#).

Table 3.3 Read Byte Protocol

START	SLAVE ADDRESS	WR	ACK	REGISTER ADDRESS	ACK	START	CLIENT ADDRESS	RD	ACK	REGISTER DATA	NACK	STOP
1->0	0101_000	0	0	XXh	0	1 -> 0	0101_000	1	0	XXh	1	0 -> 1

3.3.3 SMBus Send Byte

The Send Byte protocol is used to set the internal address register pointer to the correct address location. No data is transferred during the Send Byte protocol as shown in [Table 3.4](#).

APPLICATION NOTE: The Send Byte protocol is not functional in Deep Sleep (i.e., DSLEEP bit is set).

Table 3.4 Send Byte Protocol

START	SLAVE ADDRESS	WR	ACK	REGISTER ADDRESS	ACK	STOP
1 -> 0	0101_000	0	0	XXh	0	0 -> 1

3.3.4 SMBus Receive Byte

The Receive Byte protocol is used to read data from a register when the internal register address pointer is known to be at the right location (e.g., set via Send Byte). This is used for consecutive reads of the same register as shown in [Table 3.5](#).

APPLICATION NOTE: The Receive Byte protocol is not functional in Deep Sleep (i.e., DSLEEP bit is set).

Table 3.5 Receive Byte Protocol

START	SLAVE ADDRESS	RD	ACK	REGISTER DATA	NACK	STOP
1 -> 0	0101_000	1	0	XXh	1	0 -> 1

3.4 I²C Protocols

The CAP1133 supports I²C Block Write and Block Read.

The protocols listed below use the convention in [Table 3.1](#).

3.4.1 Block Write

The Block Write is used to write multiple data bytes to a group of contiguous registers as shown in [Table 3.6](#).

APPLICATION NOTE: When using the Block Write protocol, the internal address pointer will be automatically incremented after every data byte is received. It will wrap from FFh to 00h.

Table 3.6 Block Write Protocol

START	SLAVE ADDRESS	WR	ACK	REGISTER ADDRESS	ACK	REGISTER DATA	ACK
1 ->0	0101_000	0	0	XXh	0	XXh	0
REGISTER DATA	ACK	REGISTER DATA	ACK	...	REGISTER DATA	ACK	STOP
XXh	0	XXh	0	...	XXh	0	0 -> 1

3.4.2 Block Read

The Block Read is used to read multiple data bytes from a group of contiguous registers as shown in [Table 3.7](#).

APPLICATION NOTE: When using the Block Read protocol, the internal address pointer will be automatically incremented after every data byte is received. It will wrap from FFh to 00h.

Table 3.7 Block Read Protocol

START	SLAVE ADDRESS	WR	ACK	REGISTER ADDRESS	ACK	START	SLAVE ADDRESS	RD	ACK	REGISTER DATA
1->0	0101_000	0	0	XXh	0	1 ->0	0101_000	1	0	XXh
ACK	REGISTER DATA	ACK	REGISTER DATA	ACK	REGISTER DATA	ACK	...	REGISTER DATA	NACK	STOP
0	XXh	0	XXh	0	XXh	0	...	XXh	1	0 -> 1

Chapter 4 General Description

The CAP1133 is a multiple channel Capacitive Touch sensor with multiple power LED drivers. It contains three (3) individual capacitive touch sensor inputs with programmable sensitivity for use in touch sensor applications. Each sensor input automatically recalibrates to compensate for gradual environmental changes.

The CAP1133 also contains three (3) low side (or push-pull) LED drivers that offer full-on / off, variable rate blinking, dimness controls, and breathing. Each of the LED drivers may be linked to one of the sensor inputs to be actuated when a touch is detected. As well, each LED driver may be individually controlled via a host controller.

The CAP1133 offers multiple power states. It operates at the lowest quiescent current during its Deep Sleep state. In the low power Standby state, it can monitor one or more channels and respond to communications normally.

The device communicates with a host controller using SMBus / I²C. The host controller may poll the device for updated information at any time or it may configure the device to flag an interrupt whenever a touch is detected on any sensor pad.

A typical system diagram is shown in [Figure 4.1](#).

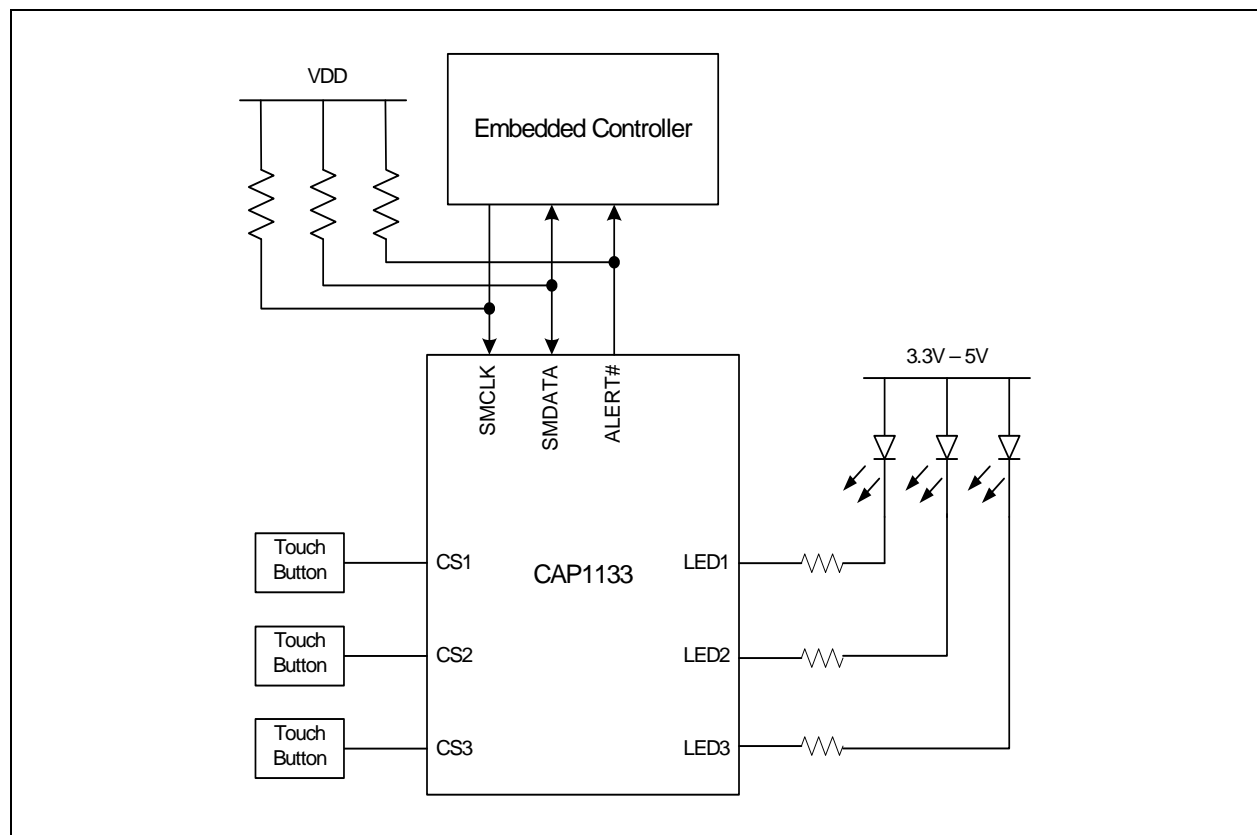

Figure 4.1 System Diagram for CAP1133

4.1 Power States

The CAP1133 has three operating states depending on the status of the STBY and DSLEEP bits. When the device transitions between power states, previously detected touches (for inactive channels) are cleared and the status bits reset.

1. Fully Active - The device is fully active. It is monitoring all active capacitive sensor inputs and driving all LED channels as defined.
2. Standby - The device is in a lower power state. It will measure a programmable number of channels using the Standby Configuration controls (see [Section 5.20](#) through [Section 5.22](#)). Interrupts will still be generated based on the active channels. The device will still respond to communications normally and can be returned to the Fully Active state of operation by clearing the STBY bit.
3. Deep Sleep - The device is in its lowest power state. It is not monitoring any capacitive sensor inputs and not driving any LEDs. All LEDs will be driven to their programmed non-actuated state and no PWM operations will be done. While in Deep Sleep, the device can be awakened by SMBus communications targeting the device. This will not cause the DSLEEP to be cleared so the device will return to Deep Sleep once all communications have stopped.

APPLICATION NOTE: In the Deep Sleep state, the LED output will be either high or low and will not be PWM'd at the min or max duty cycle.

4.2 LED Drivers

The CAP1133 contains three (3) LED drivers. Each LED driver can be linked to its respective capacitive touch sensor input or it can be controlled by the host. Each LED driver can be configured to operate in one of the following modes with either push-pull or open drain drive.

1. Direct - The LED is configured to be on or off when the corresponding input stimulus is on or off (or inverted). The brightness of the LED can be programmed from full off to full on (default). Additionally, the LED contains controls to individually configure ramping on, off, and turn-off delay.
2. Pulse 1 - The LED is configured to "Pulse" (transition ON-OFF-ON) a programmable number of times with programmable rate and min / max brightness. This behavior may be actuated when a press is detected or when a release is detected.
3. Pulse 2 - The LED is configured to "Pulse" while actuated and then "Pulse" a programmable number of times with programmable rate and min / max brightness when the sensor pad is released.
4. Breathe - The LED is configured to transition continuously ON-OFF-ON (i.e. to "Breathe") with a programmable rate and min / max brightness.

When an LED is not linked to a sensor and is actuated by the host, there's an option to assert the ALERT# pin when the initiated LED behavior has completed.

4.2.1 Linking LEDs to Capacitive Touch Sensor Inputs

All LEDs can be linked to the corresponding capacitive touch sensor input so that when the sensor input detects a touch, the corresponding LED will be actuated at one of the programmed responses.

4.3 Capacitive Touch Sensing

The CAP1133 contains three (3) independent capacitive touch sensor inputs. Each sensor input has dynamic range to detect a change of capacitance due to a touch. Additionally, each sensor input can be configured to be automatically and routinely re-calibrated.

Datasheet

4.3.1 Sensing Cycle

Each capacitive touch sensor input has controls to be activated and included in the sensing cycle. When the device is active, it automatically initiates a sensing cycle and repeats the cycle every time it finishes. The cycle polls through each active sensor input starting with CS1 and extending through CS3. As each capacitive touch sensor input is polled, its measurement is compared against a baseline “Not Touched” measurement. If the delta measurement is large enough, a touch is detected and an interrupt is generated.

The sensing cycle time is programmable (see [Section 5.10, "Averaging and Sampling Configuration Register"](#)).

4.3.2 Recalibrating Sensor Inputs

There are various options for recalibrating the capacitive touch sensor inputs. Recalibration re-sets the Base Count Registers ([Section 5.24, "Sensor Input Base Count Registers"](#)) which contain the “not touched” values used for touch detection comparisons.

APPLICATION NOTE: The device will recalibrate all sensor inputs that were disabled when it transitions from Standby. Likewise, the device will recalibrate all sensor inputs when waking out of Deep Sleep.

4.3.2.1 Manual Recalibration

The Calibration Activate Registers ([Section 5.11, "Calibration Activate Register"](#)) force recalibration of selected sensor inputs. When a bit is set, the corresponding capacitive touch sensor input will be recalibrated (both analog and digital). The bit is automatically cleared once the recalibration routine has finished.

Note: During this recalibration routine, the sensor inputs will not detect a press for up to 200ms and the Sensor Base Count Register values will be invalid. In addition, any press on the corresponding sensor pads will invalidate the recalibration.

4.3.2.2 Automatic Recalibration

Each sensor input is regularly recalibrated at a programmable rate (see [Section 5.17, "Recalibration Configuration Register"](#)). By default, the recalibration routine stores the average 64 previous measurements and periodically updates the base “not touched” setting for the capacitive touch sensor input.

Note: Automatic recalibration only works when the delta count is below the active sensor input threshold. It is disabled when a touch is detected.

4.3.2.3 Negative Delta Count Recalibration

It is possible that the device loses sensitivity to a touch. This may happen as a result of a noisy environment, an accidental recalibration during a touch, or other environmental changes. When this occurs, the base untouched sensor input may generate negative delta count values. The NEG_DELTA_CNT bits (see [Section 5.17, "Recalibration Configuration Register"](#)) can be set to force a recalibration after a specified number of consecutive negative delta readings.

Note: During this recalibration, the device will not respond to touches.

4.3.2.4 Delayed Recalibration

It is possible that a “stuck button” occurs when something is placed on a button which causes a touch to be detected for a long period. By setting the MAX_DUR_EN bit (see [Section 5.6, "Configuration Registers"](#)), a recalibration can be forced when a touch is held on a button for longer than the duration specified in the MAX_DUR bits (see [Section 5.8, "Sensor Input Configuration Register"](#)).

Note: Delayed recalibration only works when the delta count is above the active sensor input threshold. If enabled, it is invoked when a sensor pad touch is held longer than the MAX_DUR bit setting.

4.3.3 Proximity Detection

Each sensor input can be configured to detect changes in capacitance due to proximity of a touch. This circuitry detects the change of capacitance that is generated as an object approaches, but does not physically touch, the enabled sensor pad(s). When a sensor input is selected to perform proximity detection, it will be sampled from 1x to 128x per sampling cycle. The larger the number of samples that are taken, the greater the range of proximity detection is available at the cost of an increased overall sampling time.

4.3.4 Multiple Touch Pattern Detection

The multiple touch pattern (MTP) detection circuitry can be used to detect lid closure or other similar events. An event can be flagged based on either a minimum number of sensor inputs or on specific sensor inputs simultaneously exceeding an MTP threshold or having their Noise Flag Status Register bits set. An interrupt can also be generated. During an MTP event, all touches are blocked (see [Section 5.15, "Multiple Touch Pattern Configuration Register"](#)).

4.3.5 Low Frequency Noise Detection

Each sensor input has an EMI noise detector that will sense if low frequency noise is injected onto the input with sufficient power to corrupt the readings. If this occurs, the device will reject the corrupted sample and set the corresponding bit in the Noise Status register to a logic '1'.

4.3.6 RF Noise Detection

Each sensor input contains an integrated RF noise detector. This block will detect injected RF noise on the CS pin. The detector threshold is dependent upon the noise frequency. If RF noise is detected on a CS line, that sample is removed and not compared against the threshold.

4.4 ALERT# Pin

The ALERT# pin is an active low (or active high when configured) output that is driven when an interrupt event is detected.

Whenever an interrupt is generated, the INT bit (see [Section 5.1, "Main Control Register"](#)) is set. The ALERT# pin is cleared when the INT bit is cleared by the user. Additionally, when the INT bit is cleared by the user, status bits are only cleared if no touch is detected.

4.4.1 Sensor Interrupt Behavior

The sensor interrupts are generated in one of two ways:

1. An interrupt is generated when a touch is detected and, as a user selectable option, when a release is detected (by default - see [Section 5.6](#)). See [Figure 4.3](#).
2. If the repeat rate is enabled then, so long as the touch is held, another interrupt will be generated based on the programmed repeat rate (see [Figure 4.2](#)).

When the repeat rate is enabled, the device uses an additional control called MPRESS that determines whether a touch is flagged as a simple "touch" or a "press and hold". The MPRESS[3:0] bits set a minimum press timer. When the button is touched, the timer begins. If the sensor pad is released before the minimum press timer expires, it is flagged as a touch and an interrupt is generated upon release. If the sensor input detects a touch for longer than this timer value, it is flagged as a "press

Datasheet

and hold” event. So long as the touch is held, interrupts will be generated at the programmed repeat rate and upon release (if enabled).

APPLICATION NOTE: Figure 4.2 and Figure 4.3 show default operation which is to generate an interrupt upon sensor pad release and an active-low ALERT# pin.

APPLICATION NOTE: The host may need to poll the device twice to determine that a release has been detected.

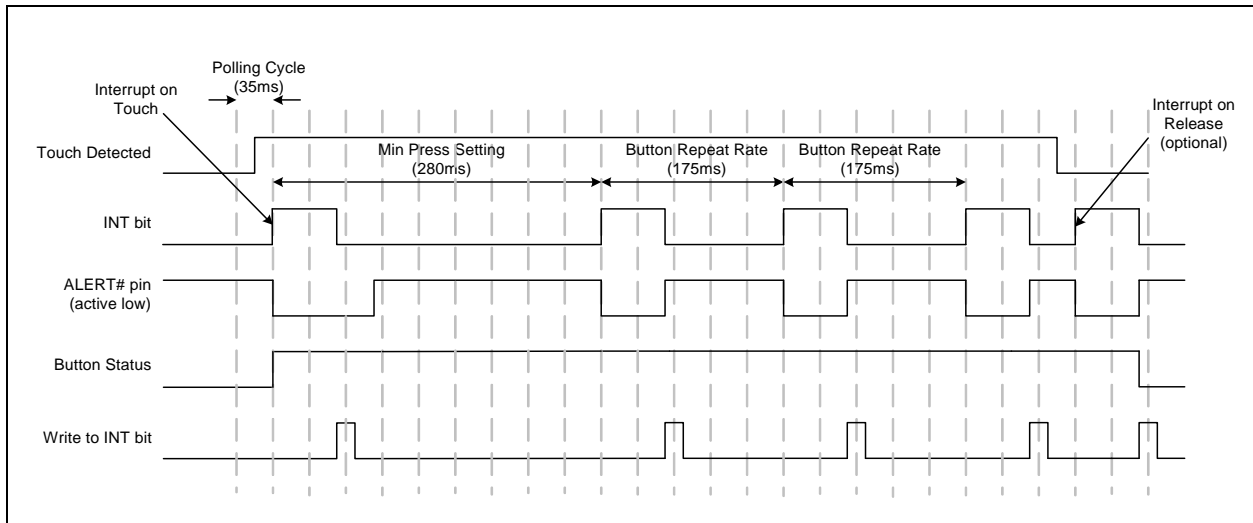

Figure 4.2 Sensor Interrupt Behavior - Repeat Rate Enabled

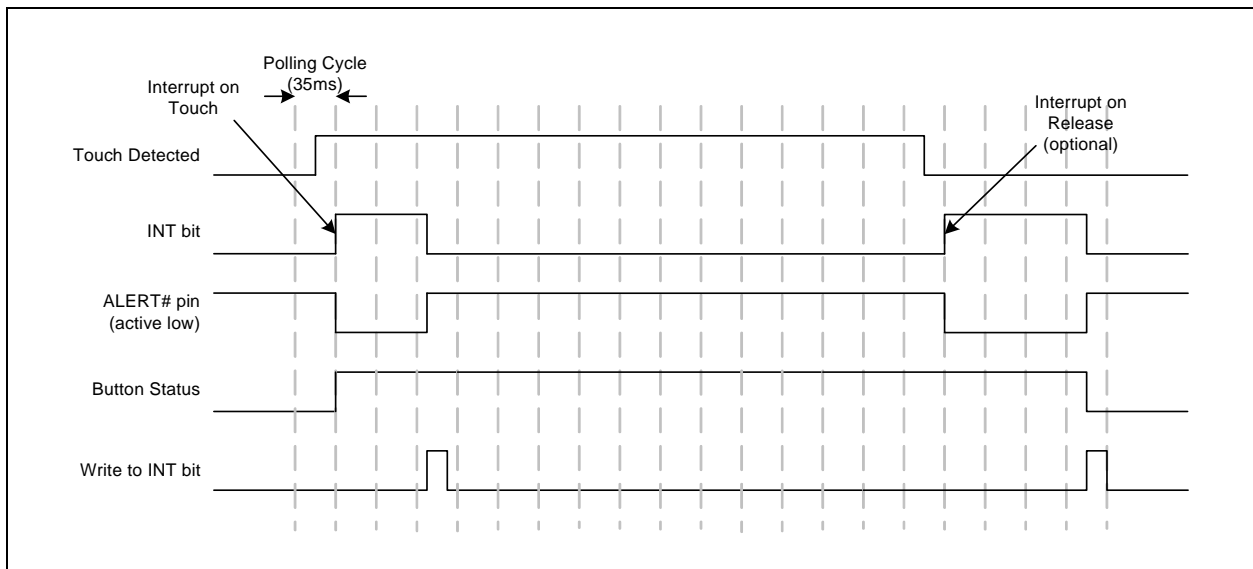

Figure 4.3 Sensor Interrupt Behavior - No Repeat Rate Enabled

Chapter 5 Register Description

The registers shown in [Table 5.1](#) are accessible through the communications protocol. An entry of ‘-’ indicates that the bit is not used and will always read ‘0’.

Table 5.1 Register Set in Hexadecimal Order

REGISTER ADDRESS	R/W	REGISTER NAME	FUNCTION	DEFAULT VALUE	PAGE
00h	R/W	Main Control	Controls general power states and power dissipation	00h	Page 26
02h	R	General Status	Stores general status bits	00h	Page 27
03h	R	Sensor Input Status	Returns the state of the sampled capacitive touch sensor inputs	00h	Page 27
04h	R	LED Status	Stores status bits for LEDs	00h	Page 27
0Ah	R	Noise Flag Status	Stores the noise flags for sensor inputs	00h	Page 28
10h	R	Sensor Input 1 Delta Count	Stores the delta count for CS1	00h	Page 29
11h	R	Sensor Input 2 Delta Count	Stores the delta count for CS2	00h	Page 29
12h	R	Sensor Input 3 Delta Count	Stores the delta count for CS3	00h	Page 29
1Fh	R/W	Sensitivity Control	Controls the sensitivity of the threshold and delta counts and data scaling of the base counts	2Fh	Page 29
20h	R/W	Configuration	Controls general functionality	20h	Page 31
21h	R/W	Sensor Input Enable	Controls whether the capacitive touch sensor inputs are sampled	07h	Page 32
22h	R/W	Sensor Input Configuration	Controls max duration and auto-repeat delay for sensor inputs operating in the full power state	A4h	Page 33
23h	R/W	Sensor Input Configuration 2	Controls the MPRESS controls for all sensor inputs	07h	Page 35
24h	R/W	Averaging and Sampling Config	Controls averaging and sampling window	39h	Page 36
26h	R/W	Calibration Activate	Forces re-calibration for capacitive touch sensor inputs	00h	Page 37
27h	R/W	Interrupt Enable	Enables Interrupts associated with capacitive touch sensor inputs	07h	Page 38
28h	R/W	Repeat Rate Enable	Enables repeat rate for all sensor inputs	07h	Page 38

Table 5.1 Register Set in Hexadecimal Order (continued)

REGISTER ADDRESS	R/W	REGISTER NAME	FUNCTION	DEFAULT VALUE	PAGE
2Ah	R/W	Multiple Touch Configuration	Determines the number of simultaneous touches to flag a multiple touch condition	80h	Page 39
2Bh	R/W	Multiple Touch Pattern Configuration	Determines the multiple touch pattern (MTP) configuration	00h	Page 39
2Dh	R/W	Multiple Touch Pattern	Determines the pattern or number of sensor inputs used by the MTP circuitry	07h	Page 41
2Fh	R/W	Recalibration Configuration	Determines re-calibration timing and sampling window	8Ah	Page 41
30h	R/W	Sensor Input 1 Threshold	Stores the delta count threshold to determine a touch for Capacitive Touch Sensor Input 1	40h	Page 43
31h	R/W	Sensor Input 2 Threshold	Stores the delta count threshold to determine a touch for Capacitive Touch Sensor Input 2	40h	Page 43
32h	R/W	Sensor Input 3 Threshold	Stores the delta count threshold to determine a touch for Capacitive Touch Sensor Input 3	40h	Page 43
38h	R/W	Sensor Input Noise Threshold	Stores controls for selecting the noise threshold for all sensor inputs	01h	Page 43
Standby Configuration Registers					
40h	R/W	Standby Channel	Controls which sensor inputs are enabled while in standby	00h	Page 44
41h	R/W	Standby Configuration	Controls averaging and cycle time while in standby	39h	Page 44
42h	R/W	Standby Sensitivity	Controls sensitivity settings used while in standby	02h	Page 46
43h	R/W	Standby Threshold	Stores the touch detection threshold for active sensor inputs in standby	40h	Page 47
44h	R/W	Configuration 2	Stores additional configuration controls for the device	40h	Page 31
Base Count Registers					
50h	R	Sensor Input 1 Base Count	Stores the reference count value for sensor input 1	C8h	Page 47
51h	R	Sensor Input 2 Base Count	Stores the reference count value for sensor input 2	C8h	Page 47
52h	R	Sensor Input 3 Base Count	Stores the reference count value for sensor input 3	C8h	Page 47
LED Controls					
71h	R/W	LED Output Type	Controls the output type for the LED outputs	00h	Page 48

Table 5.1 Register Set in Hexadecimal Order (continued)

REGISTER ADDRESS	R/W	REGISTER NAME	FUNCTION	DEFAULT VALUE	PAGE
72h	R/W	Sensor Input LED Linking	Controls linking of sensor inputs to LED channels	00h	Page 48
73h	R/W	LED Polarity	Controls the output polarity of LEDs	00h	Page 49
74h	R/W	LED Output Control	Controls the output state of the LEDs	00h	Page 50
77h	R/W	LED Linked Transition Control	Controls the transition when LEDs are linked to CS channels	00h	Page 51
79h	R/W	LED Mirror Control	Controls the mirroring of duty cycles for the LEDs	00h	Page 52
81h	R/W	LED Behavior 1	Controls the behavior and response of LEDs 1 - 3	00h	Page 52
84h	R/W	LED Pulse 1 Period	Controls the period of each breathe during a pulse	20h	Page 54
85h	R/W	LED Pulse 2 Period	Controls the period of the breathing during breathe and pulse operation	14h	Page 56
86h	R/W	LED Breathe Period	Controls the period of an LED breathe operation	5Dh	Page 57
88h	R/W	LED Config	Controls LED configuration	04h	Page 57
90h	R/W	LED Pulse 1 Duty Cycle	Determines the min and max duty cycle for the pulse operation	F0h	Page 58
91h	R/W	LED Pulse 2 Duty Cycle	Determines the min and max duty cycle for breathe and pulse operation	F0h	Page 58
92h	R/W	LED Breathe Duty Cycle	Determines the min and max duty cycle for the breathe operation	F0h	Page 58
93h	R/W	LED Direct Duty Cycle	Determines the min and max duty cycle for Direct mode LED operation	F0h	Page 58
94h	R/W	LED Direct Ramp Rates	Determines the rising and falling edge ramp rates of the LEDs	00h	Page 59
95h	R/W	LED Off Delay	Determines the off delay for all LED behaviors	00h	Page 60
B1h	R	Sensor Input 1 Calibration	Stores the upper 8-bit calibration value for sensor input 1	00h	Page 64
B2h	R	Sensor Input 2 Calibration	Stores the upper 8-bit calibration value for sensor input 2	00h	Page 64
B3h	R	Sensor Input 3 Calibration	Stores the upper 8-bit calibration value for sensor input 3	00h	Page 64
B9h	R	Sensor Input Calibration LSB 1	Stores the 2 LSBs of the calibration value for sensor inputs 1 - 3	00h	Page 64
FDh	R	Product ID	Stores a fixed value that identifies each product	54h	Page 64

Table 5.1 Register Set in Hexadecimal Order (continued)

REGISTER ADDRESS	R/W	REGISTER NAME	FUNCTION	DEFAULT VALUE	PAGE
FEh	R	Manufacturer ID	Stores a fixed value that identifies SMSC	5Dh	Page 64
FFh	R	Revision	Stores a fixed value that represents the revision number	83h	Page 64

During Power-On-Reset (POR), the default values are stored in the registers. A POR is initiated when power is first applied to the part and the voltage on the VDD supply surpasses the POR level as specified in the electrical characteristics. Any reads to undefined registers will return 00h. Writes to undefined registers will not have an effect.

When a bit is “set”, this means that the user writes a logic ‘1’ to it. When a bit is “cleared”, this means that the user writes a logic ‘0’ to it.

5.1 Main Control Register

Table 5.2 Main Control Register

ADDR	R/W	REGISTER	B7	B6	B5	B4	B3	B2	B1	B0	DEFAULT
00h	R/W	Main Control	GAIN[1:0]		STBY	DSLEEP	-	-	-	INT	00h

The Main Control register controls the primary power state of the device.

Bits 7 - 6 - GAIN[1:0] - Controls the gain used by the capacitive touch sensing circuitry. As the gain is increased, the effective sensitivity is likewise increased as a smaller delta capacitance is required to generate the same delta count values. The sensitivity settings may need to be adjusted along with the gain settings such that data overflow does not occur.

APPLICATION NOTE: The gain settings apply to both Standby and Active states.

Table 5.3 GAIN Bit Decode

GAIN[1:0]		CAPACITIVE TOUCH SENSOR GAIN
1	0	
0	0	1
0	1	2
1	0	4
1	1	8

Bit 5 - STBY - Enables Standby.

- '0' (default) - Sensor input scanning is active and LEDs are functional.
- '1' - Capacitive touch sensor input scanning is limited to the sensor inputs set in the Standby Channel register (see [Section 5.20](#)). The status registers will not be cleared until read. LEDs that are linked to capacitive touch sensor inputs will remain linked and active. Sensor inputs that are

no longer sampled will flag a release and then remain in a non-touched state. LEDs that are manually controlled will be unaffected.

Bit 4 - DSLEEP - Enables Deep Sleep by deactivating all functions.

- '0' (default) - Sensor input scanning is active and LEDs are functional.
- '1' - All sensor input scanning is disabled. All LEDs are driven to their programmed non-actuated state and no PWM operations will be done. The status registers are automatically cleared and the INT bit is cleared.

Bit 0 - INT - Indicates that there is an interrupt. When this bit is set, it asserts the ALERT# pin. If a channel detects a touch and its associated interrupt enable bit is not set to a logic '1', no action is taken.

This bit is cleared by writing a logic '0' to it. When this bit is cleared, the ALERT# pin will be deasserted and all status registers will be cleared if the condition has been removed.

- '0' - No interrupt pending.
- '1' - A touch has been detected on one or more channels and the interrupt has been asserted.

5.2 Status Registers

Table 5.4 Status Registers

ADDR	R/W	REGISTER	B7	B6	B5	B4	B3	B2	B1	B0	DEFAULT
02h	R	General Status	-	-	-	LED	-	MULT	MTP	TOUCH	00h
03h	R	Sensor Input Status	-	-	-	-	-	CS3	CS2	CS1	00h
04h	R	LED Status	-	-	-	-	-	LED3_DN	LED2_DN	LED1_DN	00h

All status bits are cleared when the device enters the Deep Sleep (DSLEEP = '1' - see [Section 5.1](#)).

5.2.1 General Status - 02h

Bit 4 - LED - Indicates that one or more LEDs have finished their programmed activity. This bit is set if any bit in the LED Status register is set.

Bit 2 - MULT - Indicates that the device is blocking detected touches due to the Multiple Touch detection circuitry (see [Section 5.14](#)). This bit will not cause the INT bit to be set and hence will not cause an interrupt.

Bit 1 - MTP - Indicates that the device has detected a number of sensor inputs that exceed the MTP threshold either via the pattern recognition or via the number of sensor inputs (see [Section 5.15](#)). This bit will cause the INT bit to be set if the MTP_ALERT bit is also set. This bit will not be cleared until the condition that caused it to be set has been removed.

Bit 0 - TOUCH - Indicates that a touch was detected. This bit is set if any bit in the Sensor Input Status register is set.

5.2.2 Sensor Input Status - 03h

The Sensor Input Status Register stores status bits that indicate a touch has been detected. A value of '0' in any bit indicates that no touch has been detected. A value of '1' in any bit indicates that a touch has been detected.

Datasheet

All bits are cleared when the INT bit is cleared and if a touch on the respective capacitive touch sensor input is no longer present. If a touch is still detected, the bits will not be cleared (but this will not cause the interrupt to be asserted - see [Section 5.6](#)).

Bit 2 - CS3 - Indicates that a touch was detected on Sensor Input 3. This sensor input can be linked to LED3.

Bit 1 - CS2 - Indicates that a touch was detected on Sensor Input 2. This sensor input can be linked to LED2.

Bit 0 - CS1 - Indicates that a touch was detected on Sensor Input 1. This sensor input can be linked to LED1.

5.2.3 LED Status - 04h

The LED Status Registers indicate when an LED has completed its configured behavior (see [Section 5.31, "LED Behavior Register"](#)) after being actuated by the host (see [Section 5.28, "LED Output Control Register"](#)). These bits are ignored when the LED is linked to a capacitive sensor input. All LED Status bits are cleared when the INT bit is cleared.

Bit 2 - LED3_DN - Indicates that LED3 has finished its behavior after being actuated by the host.

Bit 1 - LED2_DN - Indicates that LED2 has finished its behavior after being actuated by the host.

Bit 0 - LED1_DN - Indicates that LED1 has finished its behavior after being actuated by the host.

5.3 Noise Flag Status Registers**Table 5.5 Noise Flag Status Registers**

ADDR	R/W	REGISTER	B7	B6	B5	B4	B3	B2	B1	B0	DEFAULT
0Ah	R	Noise Flag Status			-	-	-	CS3_NOISE	CS2_NOISE	CS1_NOISE	00h

The Noise Flag Status registers store status bits that are generated from the analog block if the detected noise is above the operating region of the analog detector or the RF noise detector. These bits indicate that the most recently received data from the sensor input is invalid and should not be used for touch detection. So long as the bit is set for a particular channel, the delta count value is reset to 00h and thus no touch is detected.

These bits are not sticky and will be cleared automatically if the analog block does not report a noise error.

APPLICATION NOTE: If the MTP detection circuitry is enabled, these bits count as sensor inputs above the MTP threshold (see [Section 4.3.4, "Multiple Touch Pattern Detection"](#)) even if the corresponding delta count is not. If the corresponding delta count also exceeds the MTP threshold, it is not counted twice.

APPLICATION NOTE: Regardless of the state of the Noise Status bits, if low frequency noise is detected on a sensor input, that sample will be discarded unless the DIS_ANA_NOISE bit is set. As well, if RF noise is detected on a sensor input, that sample will be discarded unless the DIS_RF_NOISE bit is set.

5.4 Sensor Input Delta Count Registers

Table 5.6 Sensor Input Delta Count Registers

ADDR	R/W	REGISTER	B7	B6	B5	B4	B3	B2	B1	B0	DEFAULT
10h	R	Sensor Input 1 Delta Count	Sign	64	32	16	8	4	2	1	00h
11h	R	Sensor Input 2 Delta Count	Sign	64	32	16	8	4	2	1	00h
12h	R	Sensor Input 3 Delta Count	Sign	64	32	16	8	4	2	1	00h

The Sensor Input Delta Count registers store the delta count that is compared against the threshold used to determine if a touch has been detected. The count value represents a change in input due to the capacitance associated with a touch on one of the sensor inputs and is referenced to a calibrated base “Not Touched” count value. The delta is an instantaneous change and is updated once per sensor input per sensing cycle (see [Section 4.3.1, "Sensing Cycle"](#)).

The value presented is a standard 2's complement number. In addition, the value is capped at a value of 7Fh. A reading of 7Fh indicates that the sensitivity settings are too high and should be adjusted accordingly (see [Section 5.5](#)).

The value is also capped at a negative value of 80h for negative delta counts which may result upon a release.

5.5 Sensitivity Control Register

Table 5.7 Sensitivity Control Register

ADDR	R/W	REGISTER	B7	B6	B5	B4	B3	B2	B1	B0	DEFAULT
1Fh	R/W	Sensitivity Control	-	DELTA_SENSE[2:0]			BASE_SHIFT[3:0]				2Fh

The Sensitivity Control register controls the sensitivity of a touch detection.

Bits 6-4 DELTA_SENSE[2:0] - Controls the sensitivity of a touch detection. The sensitivity settings act to scale the relative delta count value higher or lower based on the system parameters. A setting of 000b is the most sensitive while a setting of 111b is the least sensitive. At the more sensitive settings, touches are detected for a smaller delta capacitance corresponding to a “lighter” touch. These settings are more sensitive to noise, however, and a noisy environment may flag more false touches with higher sensitivity levels.

APPLICATION NOTE: A value of 128x is the most sensitive setting available. At the most sensitivity settings, the MSB of the Delta Count register represents 64 out of ~25,000 which corresponds to a touch of approximately 0.25% of the base capacitance (or a ΔC of 25fF from a 10pF base capacitance). Conversely, a value of 1x is the least sensitive setting available. At these settings, the MSB of the Delta Count register corresponds to a delta count of 8192 counts out of ~25,000 which corresponds to a touch of approximately 33% of the base capacitance (or a ΔC of 3.33pF from a 10pF base capacitance).

Table 5.8 DELTA_SENSE Bit Decode

DELTA_SENSE[2:0]			SENSITIVITY MULTIPLIER
2	1	0	
0	0	0	128x (most sensitive)
0	0	1	64x
0	1	0	32x (default)
0	1	1	16x
1	0	0	8x
1	0	1	4x
1	1	0	2x
1	1	1	1x - (least sensitive)

Bits 3 - 0 - BASE_SHIFT[3:0] - Controls the scaling and data presentation of the Base Count registers. The higher the value of these bits, the larger the range and the lower the resolution of the data presented. The scale factor represents the multiplier to the bit-weighting presented in these register descriptions.

APPLICATION NOTE: The BASE_SHIFT[3:0] bits normally do not need to be updated. These settings will not affect touch detection or sensitivity. These bits are sometimes helpful in analyzing the Cap Sensing board performance and stability.

Table 5.9 BASE_SHIFT Bit Decode

BASE_SHIFT[3:0]				DATA SCALING FACTOR
3	2	1	0	
0	0	0	0	1x
0	0	0	1	2x
0	0	1	0	4x
0	0	1	1	8x
0	1	0	0	16x
0	1	0	1	32x
0	1	1	0	64x
0	1	1	1	128x
1	0	0	0	256x
All others				256x (default = 1111b)

5.6 Configuration Registers

Table 5.10 Configuration Registers

ADDR	R/W	REGISTER	B7	B6	B5	B4	B3	B2	B1	B0	DEFAULT
20h	R/W	Configuration	TIMEOUT	-	DIS_DIG_NOISE	DIS_ANA_NOISE	MAX_DUR_EN	-	-	-	A0h (rev B) 20h (rev C)
44h	R/W	Configuration 2	INV_LINK_TRAN	ALT_POL	BLK_PWR_CTRL	BLK_POL_MIR	SHOW_RF_NOISE	DIS_RF_NOISE	-	INT_REL_n	40h

The Configuration registers control general global functionality that affects the entire device.

5.6.1 Configuration - 20h

Bit 7 - TIMEOUT - Enables the timeout and idle functionality of the SMBus protocol.

- '0' (default for Functional Revision C) - The SMBus timeout and idle functionality are disabled. The SMBus interface will not time out if the clock line is held low. Likewise, it will not reset if both the data and clock lines are held high for longer than 200us. This is used for I²C compliance.
- '1' (default for Functional Revision B) - The SMBus timeout and idle functionality are enabled. The SMBus interface will time out if the clock line is held low for longer than 30ms. Likewise, it will reset if both the data and clock lines are held high for longer than 200us.

Bit 5 - DIS_DIG_NOISE - Determines whether the digital noise threshold (see [Section 5.19, "Sensor Input Noise Threshold Register"](#)) is used by the device. Setting this bit disables the feature.

- '0' - The digital noise threshold is used. If a delta count value exceeds the noise threshold but does not exceed the touch threshold, the sample is discarded and not used for the automatic re-calibration routine.
- '1' (default) - The noise threshold is disabled. Any delta count that is less than the touch threshold is used for the automatic re-calibration routine.

Bit 4 - DIS_ANA_NOISE - Determines whether the analog noise filter is enabled. Setting this bit disables the feature.

- '0' (default) - If low frequency noise is detected by the analog block, the delta count on the corresponding channel is set to 0. Note that this does not require that Noise Status bits be set.
- '1' - A touch is not blocked even if low frequency noise is detected.

Bit 3 - MAX_DUR_EN - Determines whether the maximum duration recalibration is enabled.

- '0' (default) - The maximum duration recalibration functionality is disabled. A touch may be held indefinitely and no re-calibration will be performed on any sensor input.
- '1' - The maximum duration recalibration functionality is enabled. If a touch is held for longer than the MAX_DUR bit settings, then the re-calibration routine will be restarted (see [Section 5.8](#)).

5.6.2 Configuration 2 - 44h

Bit 7 - INV_LINK_TRAN - Determines the behavior of the Linked LED Transition controls (see [Section 5.29](#)).

- '0' (default) - The Linked LED Transition controls set the min duty cycle equal to the max duty cycle.
- '1' - The Linked LED Transition controls will invert the touch signal. For example, a touch signal will be inverted to a non-touched signal.

Datasheet

Bit 6 - ALT_POL - Determines the ALERT# pin polarity and behavior.

- '0' - The ALERT# pin is active high and push-pull.
- '1' (default) - The ALERT# pin is active low and open drain.

Bit 5 - BLK_PWR_CTRL - Determines whether the device will reduce power consumption while waiting between conversion time completion and the end of the polling cycle.

- '0' (default) - The device will always power down as much as possible during the time between the end of the last conversion and the end of the polling cycle.
- '1' - The device will not power down the Cap Sensor during the time between the end of the last conversion and the end of the polling cycle.

Bit 4 - BLK_POL_MIR - Determines whether the LED Mirror Control register bits are linked to the LED Polarity bits. Setting this bit blocks the normal behavior which is to automatically set and clear the LED Mirror Control bits when the LED Polarity bits are set or cleared.

- '0' (default) - When the LED Polarity controls are set, the corresponding LED Mirror control is automatically set. Likewise, when the LED Polarity controls are cleared, the corresponding LED Mirror control is also cleared.
- '1' - When the LED Polarity controls are set, the corresponding LED Mirror control is not automatically set.

Bit 3 - SHOW_RF_NOISE - Determines whether the Noise Status bits will show RF Noise as the only input source.

- '0' (default) - The Noise Status registers will show both RF noise and low frequency EMI noise if either is detected on a capacitive touch sensor input.
- '1' - The Noise Status registers will only show RF noise if it is detected on a capacitive touch sensor input. EMI noise will still be detected and touches will be blocked normally; however, the status bits will not be updated.

Bit 2 - DIS_RF_NOISE - Determines whether the RF noise filter is enabled. Setting this bit disables the feature.

- '0' (default) - If RF noise is detected by the analog block, the delta count on the corresponding channel is set to 0. Note that this does not require that Noise Status bits be set.
- '1' - A touch is not blocked even if RF noise is detected.

Bit 0 - INT_REL_n - Controls the interrupt behavior when a release is detected on a button.

- '0' (default) - An interrupt is generated when a press is detected and again when a release is detected and at the repeat rate (if enabled - see [Section 5.13](#)).
- '1' - An interrupt is generated when a press is detected and at the repeat rate but not when a release is detected.

5.7 Sensor Input Enable Registers

Table 5.11 Sensor Input Enable Registers

ADDR	R/W	REGISTER	B7	B6	B5	B4	B3	B2	B1	B0	DEFAULT
21h	R/W	Sensor Input Enable	-	-	-	-	-	CS3_EN	CS2_EN	CS1_EN	07h

The Sensor Input Enable registers determine whether a capacitive touch sensor input is included in the sampling cycle. The length of the sampling cycle is not affected by the number of sensor inputs measured.

Bit 2 - CS3_EN - Enables the CS3 input to be included during the sampling cycle.

- '0' - The CS3 input is not included in the sampling cycle.
- '1' (default) - The CS3 input is included in the sampling cycle.

Bit 1 - CS2_EN - Enables the CS2 input to be included during the sampling cycle.

Bit 0 - CS1_EN - Enables the CS1 input to be included during the sampling cycle.

5.8 Sensor Input Configuration Register

Table 5.12 Sensor Input Configuration Register

ADDR	R/W	REGISTER	B7	B6	B5	B4	B3	B2	B1	B0	DEFAULT
22h	R/W	Sensor Input Configuration	MAX_DUR[3:0]				RPT_RATE[3:0]				A4h

The Sensor Input Configuration Register controls timings associated with the Capacitive sensor inputs 1 - 3.

Bits 7 - 4 - MAX_DUR[3:0] - (default 1010b) - Determines the maximum time that a sensor pad is allowed to be touched until the capacitive touch sensor input is recalibrated, as shown in [Table 5.13](#).

Table 5.13 MAX_DUR Bit Decode

MAX_DUR[3:0]				TIME BEFORE RECALIBRATION
3	2	1	0	
0	0	0	0	560ms
0	0	0	1	840ms
0	0	1	0	1120ms
0	0	1	1	1400ms
0	1	0	0	1680ms
0	1	0	1	2240ms
0	1	1	0	2800ms
	1	1	1	3360ms

Datasheet

Table 5.13 MAX_DUR Bit Decode (continued)

MAX_DUR[3:0]				TIME BEFORE RECALIBRATION
3	2	1	0	
1	0	0	0	3920ms
1	0	0	1	4480ms
1	0	1	0	5600ms (default)
1	0	1	1	6720ms
1	1	0	0	7840ms
1	1	0	1	8906ms
1	1	1	0	10080ms
1	1	1	1	11200ms

Bits 3 - 0 - RPT_RATE[3:0] - (default 0100b) Determines the time duration between interrupt assertions when auto repeat is enabled. The resolution is 35ms the range is from 35ms to 560ms as shown in [Table 5.14](#).

Table 5.14 RPT_RATE Bit Decode

RPT_RATE[3:0]				INTERRUPT REPEAT RATE
3	2	1	0	
0	0	0	0	35ms
0	0	0	1	70ms
0	0	1	0	105ms
0	0	1	1	140ms
0	1	0	0	175ms (default)
0	1	0	1	210ms
0	1	1	0	245ms
0	1	1	1	280ms
1	0	0	0	315ms
1	0	0	1	350ms
1	0	1	0	385ms
1	0	1	1	420ms
1	1	0	0	455ms
1	1	0	1	490ms
1	1	1	0	525ms
1	1	1	1	560ms

5.9 Sensor Input Configuration 2 Register

Table 5.15 Sensor Input Configuration 2 Register

ADDR	R/W	REGISTER	B7	B6	B5	B4	B3	B2	B1	B0	DEFAULT
23h	R/W	Sensor Input Configuration 2	-	-	-	-	M_PRESS[3:0]			07h	

Bits 3 - 0 - M_PRESS[3:0] - (default 0111b) - Determines the minimum amount of time that sensor inputs configured to use auto repeat must detect a sensor pad touch to detect a “press and hold” event. If the sensor input detects a touch for longer than the M_PRESS[3:0] settings, a “press and hold” event is detected. If a sensor input detects a touch for less than or equal to the M_PRESS[3:0] settings, a touch event is detected.

The resolution is 35ms the range is from 35ms to 560ms as shown in [Table 5.16](#).

Table 5.16 M_PRESS Bit Decode

M_PRESS[3:0]				M_PRESS SETTINGS
3	2	1	0	
0	0	0	0	35ms
0	0	0	1	70ms
0	0	1	0	105ms
0	0	1	1	140ms
0	1	0	0	175ms
0	1	0	1	210ms
0	1	1	0	245ms
0	1	1	1	280ms (default)
1	0	0	0	315ms
1	0	0	1	350ms
1	0	1	0	385ms
1	0	1	1	420ms
1	1	0	0	455ms
1	1	0	1	490ms
1	1	1	0	525ms
1	1	1	1	560ms

5.10 Averaging and Sampling Configuration Register

Table 5.17 Averaging and Sampling Configuration Register

ADDR	R/W	REGISTER	B7	B6	B5	B4	B3	B2	B1	B0	DEFAULT
24h	R/W	Averaging and Sampling Config		AVG[2:0]			SAMP_TIME[1:0]		CYCLE_TIME [1:0]		39h

The Averaging and Sampling Configuration register controls the number of samples taken and the total sensor input cycle time for all active sensor inputs while the device is functioning in Active state.

Bits 6 - 4 - AVG[2:0] - Determines the number of samples that are taken for all active channels during the sensor cycle as shown in [Table 5.18](#). All samples are taken consecutively on the same channel before the next channel is sampled and the result is averaged over the number of samples measured before updating the measured results.

For example, if CS1, CS2, and CS3 are sampled during the sensor cycle, and the AVG[2:0] bits are set to take 4 samples per channel, then the full sensor cycle will be: CS1, CS1, CS1, CS1, CS2, CS2, CS2, CS2, CS3, CS3, CS3, CS3.

Table 5.18 AVG Bit Decode

AVG[2:0]			NUMBER OF SAMPLES TAKEN PER MEASUREMENT
2	1	0	
0	0	0	1
0	0	1	2
0	1	0	4
0	1	1	8 (default)
1	0	0	16
1	0	1	32
1	1	0	64
1	1	1	128

Bits 3 - 2 - SAMP_TIME[1:0] - Determines the time to take a single sample as shown in [Table 5.19](#).

Table 5.19 SAMP_TIME Bit Decode

SAMP_TIME[1:0]		SAMPLE TIME
1	0	
0	0	320us
0	1	640us
1	0	1.28ms (default)

Table 5.19 SAMP_TIME Bit Decode (continued)

SAMP_TIME[1:0]		SAMPLE TIME
1	0	
1	1	2.56ms

Bits 1 - 0 - CYCLE_TIME[1:0] - Determines the overall cycle time for all measured channels during normal operation as shown in Table 5.20. All measured channels are sampled at the beginning of the cycle time. If additional time is remaining, then the device is placed into a lower power state for the remaining duration of the cycle.

Table 5.20 CYCLE_TIME Bit Decode

CYCLE_TIME[1:0]		OVERALL CYCLE TIME
1	0	
0	0	35ms
0	1	70ms (default)
1	0	105ms
1	1	140ms

APPLICATION NOTE: The programmed cycle time is only maintained if the total averaging time for all samples is less than the programmed cycle. The AVG[2:0] bits will take priority so that if more samples are required than would normally be allowed during the cycle time, the cycle time will be extended as necessary to accommodate the number of samples to be measured.

5.11 Calibration Activate Register

Table 5.21 Calibration Activate Register

ADDR	R/W	REGISTER	B7	B6	B5	B4	B3	B2	B1	B0	DEFAULT
26h	R/W	Calibration Activate			-	-	-	CS3_CAL	CS2_CAL	CS1_CAL	00h

The Calibration Activate register forces the respective sensor inputs to be re-calibrated affecting both the analog and digital blocks. During the re-calibration routine, the sensor inputs will not detect a press for up to 600ms and the Sensor Input Base Count register values will be invalid. During this time, any press on the corresponding sensor pads will invalidate the re-calibration. When finished, the CALX[9:0] bits will be updated (see Section 5.39).

When the corresponding bit is set, the device will perform the calibration and the bit will be automatically cleared once the re-calibration routine has finished.

Bit 2 - CS3_CAL - When set, the CS3 input is re-calibrated. This bit is automatically cleared once the sensor input has been re-calibrated successfully.

Bit 1 - CS2_CAL - When set, the CS2 input is re-calibrated. This bit is automatically cleared once the sensor input has been re-calibrated successfully.

Datasheet

Bit 0 - CS1_CAL - When set, the CS1 input is re-calibrated. This bit is automatically cleared once the sensor input has been re-calibrated successfully.

5.12 Interrupt Enable Register

Table 5.22 Interrupt Enable Register

ADDR	R/W	REGISTER	B7	B6	B5	B4	B3	B2	B1	B0	DEFAULT
27h	R/W	Interrupt Enable			-	-	-	CS3_INT_EN	CS2_INT_EN	CS1_INT_EN	07h

The Interrupt Enable register determines whether a sensor pad touch or release (if enabled) causes the interrupt pin to be asserted.

Bit 2 - CS3_INT_EN - Enables the interrupt pin to be asserted if a touch is detected on CS3 (associated with the CS3 status bit).

- '0' - The interrupt pin will not be asserted if a touch is detected on CS3 (associated with the CS6 status bit).
- '1' (default) - The interrupt pin will be asserted if a touch is detected on CS3 (associated with the CS6 status bit).

Bit 1 - CS2_INT_EN - Enables the interrupt pin to be asserted if a touch is detected on CS2 (associated with the CS2 status bit).

Bit 0 - CS1_INT_EN - Enables the interrupt pin to be asserted if a touch is detected on CS1 (associated with the CS1 status bit).

5.13 Repeat Rate Enable Register

Table 5.23 Repeat Rate Enable Register

ADDR	R/W	REGISTER	B7	B6	B5	B4	B3	B2	B1	B0	DEFAULT
28h	R/W	Repeat Rate Enable	-	-	-	-	-	CS3_RPT_EN	CS2_RPT_EN	CS1_RPT_EN	07h

The Repeat Rate Enable register enables the repeat rate of the sensor inputs as described in [Section 4.4.1](#).

Bit 2 - CS3_RPT_EN - Enables the repeat rate for capacitive touch sensor input 3.

- '0' - The repeat rate for CS3 is disabled. It will only generate an interrupt when a touch is detected and when a release is detected no matter how long the touch is held for.
- '1' (default) - The repeat rate for CS3 is enabled. In the case of a "touch" event, it will generate an interrupt when a touch is detected and a release is detected (as determined by the INT_REL_n bit - see [Section 5.6](#)). In the case of a "press and hold" event, it will generate an interrupt when a touch is detected and at the repeat rate so long as the touch is held d.

Bit 1 - CS2_RPT_EN - Enables the repeat rate for capacitive touch sensor input 2.

Bit 0 - CS1_RPT_EN - Enables the repeat rate for capacitive touch sensor input 1.

5.14 Multiple Touch Configuration Register

Table 5.24 Multiple Touch Configuration

ADDR	R/W	REGISTER	B7	B6	B5	B4	B3	B2	B1	B0	DEFAULT
2Ah	R/W	Multiple Touch Config	MULT_BLK_EN	-	-	-	B_MULT_T[1:0]	-	-	-	80h

The Multiple Touch Configuration register controls the settings for the multiple touch detection circuitry. These settings determine the number of simultaneous buttons that may be pressed before additional buttons are blocked and the MULT status bit is set.

Bit 7 - MULT_BLK_EN - Enables the multiple button blocking circuitry.

- '0' - The multiple touch circuitry is disabled. The device will not block multiple touches.
- '1' (default) - The multiple touch circuitry is enabled. The device will flag the number of touches equal to programmed multiple touch threshold and block all others. It will remember which sensor inputs are valid and block all others until that sensor pad has been released. Once a sensor pad has been released, the N detected touches (determined via the cycle order of CS1 - CS3) will be flagged and all others blocked.

Bits 3 - 2 - B_MULT_T[1:0] - Determines the number of simultaneous touches on all sensor pads before a Multiple Touch Event is detected and sensor inputs are blocked. The bit decode is given by [Table 5.25](#).

Table 5.25 B_MULT_T Bit Decode

B_MULT_T[1:0]		NUMBER OF SIMULTANEOUS TOUCHES
1	0	
0	0	1 (default)
0	1	2
1	0	3
1	1	3

5.15 Multiple Touch Pattern Configuration Register

Table 5.26 Multiple Touch Pattern Configuration

ADDR	R/W	REGISTER	B7	B6	B5	B4	B3	B2	B1	B0	DEFAULT
2Bh	R/W	Multiple Touch Pattern Config	MTP_EN	-	-		MTP_TH[1:0]	COMP_PTRN	MTP_ALERT		00h

The Multiple Touch Pattern Configuration register controls the settings for the multiple touch pattern detection circuitry. This circuitry works like the multiple touch detection circuitry with the following differences:

Datasheet

1. The detection threshold is a percentage of the touch detection threshold as defined by the MTP_TH[1:0] bits whereas the multiple touch circuitry uses the touch detection threshold.
2. The MTP detection circuitry either will detect a specific pattern of sensor inputs as determined by the Multiple Touch Pattern register settings or it will use the Multiple Touch Pattern register settings to determine a minimum number of sensor inputs that will cause the MTP circuitry to flag an event. When using pattern recognition mode, if all of the sensor inputs set by the Multiple Touch Pattern register have a delta count greater than the MTP threshold or have their corresponding Noise Flag Status bits set, the MTP bit will be set. When using the absolute number mode, if the number of sensor inputs with thresholds above the MTP threshold or with Noise Flag Status bits set is equal to or greater than this number, the MTP bit will be set.
3. When an MTP event occurs, all touches are blocked and an interrupt is generated.
4. All sensor inputs will remain blocked so long as the requisite number of sensor inputs are above the MTP threshold or have Noise Flag Status bits set. Once this condition is removed, touch detection will be restored. Note that the MTP status bit is only cleared by writing a '0' to the INT bit once the condition has been removed.

Bit 7 - MTP_EN - Enables the multiple touch pattern detection circuitry.

- '0' (default) - The MTP detection circuitry is disabled.
- '1' - The MTP detection circuitry is enabled.

Bits 3-2 - MTP_TH[1:0] - Determine the MTP threshold, as shown in [Table 5.27](#). This threshold is a percentage of sensor input threshold (see [Section 5.18, "Sensor Input Threshold Registers"](#)) when the device is in the Fully Active state or of the standby threshold (see [Section 5.23, "Standby Threshold Register"](#)) when the device is in the Standby state.

Table 5.27 MTP_TH Bit Decode

MTP_TH[1:0]		THRESHOLD DIVIDE SETTING
1	0	
0	0	12.5% (default)
0	1	25%
1	0	37.5%
1	1	100%

Bit 1 - COMP_PTRN - Determines whether the MTP detection circuitry will use the Multiple Touch Pattern register as a specific pattern of sensor inputs or as an absolute number of sensor inputs.

- '0' (default) - The MTP detection circuitry will use the Multiple Touch Pattern register bit settings as an absolute minimum number of sensor inputs that must be above the threshold or have Noise Flag Status bits set. The number will be equal to the number of bits set in the register.
- '1' - The MTP detection circuitry will use pattern recognition. Each bit set in the Multiple Touch Pattern register indicates a specific sensor input that must have a delta count greater than the MTP threshold or have a Noise Flag Status bit set. If the criteria are met, the MTP status bit will be set.

Bit 0 - MTP_ALERT - Enables an interrupt if an MTP event occurs. In either condition, the MTP status bit will be set.

- '0' (default) - If an MTP event occurs, the ALERT# pin is not asserted.
- '1' - If an MTP event occurs, the ALERT# pin will be asserted.

5.16 Multiple Touch Pattern Register

Table 5.28 Multiple Touch Pattern Register

ADDR	R/W	REGISTER	B7	B6	B5	B4	B3	B2	B1	B0	DEFAULT
2Dh	R/W	Multiple Touch Pattern			-	-	-	CS3_PTRN	CS2_PTRN	CS1_PTRN	07h

The Multiple Touch Pattern register acts as a pattern to identify an expected sensor input profile for diagnostics or other significant events. There are two methods for how the Multiple Touch Pattern register is used: as specific sensor inputs or number of sensor input that must exceed the MTP threshold or have Noise Flag Status bits set. Which method is used is based on the COMP_PTRN bit (see [Section 5.15](#)). The methods are described below.

1. Specific Sensor Inputs: If, during a single polling cycle, the specific sensor inputs above the MTP threshold or with Noise Flag Status bits set match those bits set in the Multiple Touch Pattern register, an MTP event is flagged.
2. Number of Sensor Inputs: If, during a single polling cycle, the number of sensor inputs with a delta count above the MTP threshold or with Noise Flag Status bits set is equal to or greater than the number of pattern bits set, an MTP event is flagged.

Bit 2 - CS3_PTRN - Determines whether CS3 is considered as part of the Multiple Touch Pattern.

- '0' - CS3 is not considered a part of the pattern.
- '1' - CS3 is considered a part of the pattern or the absolute number of sensor inputs that must have a delta count greater than the MTP threshold or have the Noise Flag Status bit set is increased by 1.

Bit 1 - CS2_PTRN - Determines whether CS2 is considered as part of the Multiple Touch Pattern.

Bit 0 - CS1_PTRN - Determines whether CS1 is considered as part of the Multiple Touch Pattern.

5.17 Recalibration Configuration Register

Table 5.29 Recalibration Configuration Registers

ADDR	R/W	REGISTER	B7	B6	B5	B4	B3	B2	B1	B0	DEFAULT
2Fh	R/W	Recalibration Configuration	BUT_LD_TH	NO_CLR_INTD	NO_CLR_NEG	NEG_DELTA_CNT[1:0]		CAL_CFG[2:0]			8Ah

The Recalibration Configuration register controls the automatic re-calibration routine settings as well as advanced controls to program the Sensor Input Threshold register settings.

Bit 7 - BUT_LD_TH - Enables setting all Sensor Input Threshold registers by writing to the Sensor Input 1 Threshold register.

- '0' - Each Sensor Input X Threshold register is updated individually.
- '1' (default) - Writing the Sensor Input 1 Threshold register will automatically overwrite the Sensor Input Threshold registers for all sensor inputs (Sensor Input Threshold 1 through Sensor Input Threshold 3). The individual Sensor Input X Threshold registers (Sensor Input 2 Threshold and Sensor Input 3 Threshold) can be individually updated at any time.

Datasheet

Bit 6 - NO_CLR_INTD - Controls whether the accumulation of intermediate data is cleared if the noise status bit is set.

- '0' (default) - The accumulation of intermediate data is cleared if the noise status bit is set.
- '1' - The accumulation of intermediate data is not cleared if the noise status bit is set.

APPLICATION NOTE: Bits 5 and 6 should both be set to the same value. Either both should be set to '0' or both should be set to '1'.

Bit 5 - NO_CLR_NEG - Controls whether the consecutive negative delta counts counter is cleared if the noise status bit is set.

- '0' (default) - The consecutive negative delta counts counter is cleared if the noise status bit is set.
- '1' - The consecutive negative delta counts counter is not cleared if the noise status bit is set.

Bits 4 - 3 - NEG_DELTA_CNT[1:0] - Determines the number of negative delta counts necessary to trigger a digital re-calibration as shown in [Table 5.30](#).

Table 5.30 NEG_DELTA_CNT Bit Decode

NEG_DELTA_CNT[1:0]		NUMBER OF CONSECUTIVE NEGATIVE DELTA COUNT VALUES
1	0	
0	0	8
0	1	16 (default)
1	0	32
1	1	None (disabled)

Bits 2 - 0 - CAL_CFG[2:0] - Determines the update time and number of samples of the automatic re-calibration routine. The settings apply to all sensor inputs universally (though individual sensor inputs can be configured to support re-calibration - see [Section 5.11](#)).

Table 5.31 CAL_CFG Bit Decode

CAL_CFG[2:0]			RECALIBRATION SAMPLES (SEE Note 5.1)	UPDATE TIME (SEE Note 5.2)
2	1	0		
0	0	0	16	16
0	0	1	32	32
0	1	0	64	64 (default)
0	1	1	128	128
1	0	0	256	256
1	0	1	256	1024
1	1	0	256	2048
1	1	1	256	4096

Note 5.1 Recalibration Samples refers to the number of samples that are measured and averaged before the Base Count is updated however does not control the base count update period.

Note 5.2 Update Time refers to the amount of time (in polling cycle periods) that elapses before the Base Count is updated. The time will depend upon the number of channels active, the averaging setting, and the programmed cycle time.

5.18 Sensor Input Threshold Registers

Table 5.32 Sensor Input Threshold Registers

ADDR	R/W	REGISTER	B7	B6	B5	B4	B3	B2	B1	B0	DEFAULT
30h	R/W	Sensor Input 1 Threshold	-	64	32	16	8	4	2	1	40h
31h	R/W	Sensor Input 2 Threshold	-	64	32	16	8	4	2	1	40h
32h	R/W	Sensor Input 3 Threshold	-	64	32	16	8	4	2	1	40h

The Sensor Input Threshold registers store the delta threshold that is used to determine if a touch has been detected. When a touch occurs, the input signal of the corresponding sensor pad changes due to the capacitance associated with a touch. If the sensor input change exceeds the threshold settings, a touch is detected.

When the BUT_LD_TH bit is set (see [Section 5.17](#) - bit 7), writing data to the Sensor Input 1 Threshold register will update all of the sensor input threshold registers (31h - 32h inclusive).

5.19 Sensor Input Noise Threshold Register

Table 5.33 Sensor Input Noise Threshold Register

ADDR	R/W	REGISTER	B7	B6	B5	B4	B3	B2	B1	B0	DEFAULT
38h	R/W	Sensor Input Noise Threshold							CS_BN_TH [1:0]		01h

The Sensor Input Noise Threshold register controls the value of a secondary internal threshold to detect noise and improve the automatic recalibration routine. If a capacitive touch sensor input exceeds the Sensor Input Noise Threshold but does not exceed the sensor input threshold, it is determined to be caused by a noise spike. That sample is not used by the automatic re-calibration routine. This feature can be disabled by setting the DIS_DIG_NOISE bit.

Bits 1-0 - CS1_BN_TH[1:0] - Controls the noise threshold for all capacitive touch sensor inputs, as shown in [Table 5.34](#). The threshold is proportional to the threshold setting.

Table 5.34 CSx_BN_TH Bit Decode

CS_BN_TH[1:0]		PERCENT THRESHOLD SETTING
1	0	
0	0	25%
0	1	37.5% (default)
1	0	50%
1	1	62.5%

5.20 Standby Channel Register

Table 5.35 Standby Channel Register

ADDR	R/W	REGISTER	B7	B6	B5	B4	B3	B2	B1	B0	DEFAULT
40h	R/W	Standby Channel	-	-	-	-	-	CS3_STBY	CS2_STBY	CS1_STBY	00h

The Standby Channel register controls which (if any) capacitive touch sensor inputs are active during Standby.

Bit 2 - CS3_STBY - Controls whether the CS3 channel is active in Standby.

- '0' (default) - The CS3 channel not be sampled during Standby mode.
- '1' - The CS3 channel will be sampled during Standby Mode. It will use the Standby threshold setting, and the standby averaging and sensitivity settings.

Bit 1 - CS2_STBY - Controls whether the CS2 channel is active in Standby.

Bit 0 - CS1_STBY - Controls whether the CS1 channel is active in Standby.

5.21 Standby Configuration Register

Table 5.36 Standby Configuration Register

ADDR	R/W	REGISTER	B7	B6	B5	B4	B3	B2	B1	B0	DEFAULT
41h	R/W	Standby Configuration	AVG_SUM	STBY_AVG[2:0]		STBY_SAMP_TIME[1:0]		STBY_CY_TIME[1:0]			39h

The Standby Configuration register controls averaging and cycle time for those sensor inputs that are active in Standby. This register is useful for detecting proximity on a small number of sensor inputs as it allows the user to change averaging and sample times on a limited number of sensor inputs and still maintain normal functionality in the fully active state.

Bit 7 - AVG_SUM - Determines whether the active sensor inputs will average the programmed number of samples or whether they will accumulate for the programmed number of samples.

- '0' - (default) - The active sensor input delta count values will be based on the average of the programmed number of samples when compared against the threshold.
- '1' - The active sensor input delta count values will be based on the summation of the programmed number of samples when compared against the threshold. This bit should only be set when performing proximity detection as a physical touch will overflow the delta count registers and may result in false readings.

Bits 6 - 4 - STBY_AVG[2:0] - Determines the number of samples that are taken for all active channels during the sensor cycle as shown in [Table 5.37](#). All samples are taken consecutively on the same channel before the next channel is sampled and the result is averaged over the number of samples measured before updating the measured results.

Table 5.37 STBY_AVG Bit Decode

STBY_AVG[2:0]			NUMBER OF SAMPLES TAKEN PER MEASUREMENT
2	1	0	
0	0	0	1
0	0	1	2
0	1	0	4
0	1	1	8 (default)
1	0	0	16
1	0	1	32
1	1	0	64
1	1	1	128

Bit 3-2 - STBY_SAMP_TIME[1:0] - Determines the time to take a single sample when the device is in Standby as shown in [Table 5.38](#).

Table 5.38 STBY_SAMP_TIME Bit Decode

STBY_SAMP_TIME[1:0]		SAMPLING TIME
1	0	
0	0	320us
0	1	640us
1	0	1.28ms (default)
1	1	2.56ms

Bits 1 - 0 - STBY_CY_TIME[2:0] - Determines the overall cycle time for all measured channels during standby operation as shown in [Table 5.39](#). All measured channels are sampled at the beginning of the cycle time. If additional time is remaining, the device is placed into a lower power state for the remaining duration of the cycle.

Table 5.39 STBY_CY_TIME Bit Decode

STBY_CY_TIME[1:0]		OVERALL CYCLE TIME
1	0	
0	0	35ms
0	1	70ms (default)
1	0	105ms
1	1	140ms

APPLICATION NOTE: The programmed cycle time is only maintained if the total averaging time for all samples is less than the programmed cycle. The STBY_AVG[2:0] bits will take priority so that if more samples are required than would normally be allowed during the cycle time, the cycle time will be extended as necessary to accommodate the number of samples to be measured.

5.22 Standby Sensitivity Register

Table 5.40 Standby Sensitivity Register

ADDR	R/W	REGISTER	B7	B6	B5	B4	B3	B2	B1	B0	DEFAULT
42h	R/W	Standby Sensitivity	-	-	-	-	-	STBY_SENSE[2:0]			02h

The Standby Sensitivity register controls the sensitivity for sensor inputs that are active in Standby.

Bits 2 - 0 - STBY_SENSE[2:0] - Controls the sensitivity for sensor inputs that are active in Standby. The sensitivity settings act to scale the relative delta count value higher or lower based on the system parameters. A setting of 000b is the most sensitive while a setting of 111b is the least sensitive. At the more sensitive settings, touches are detected for a smaller delta C corresponding to a "lighter" touch. These settings are more sensitive to noise however and a noisy environment may flag more false touches than higher sensitivity levels.

APPLICATION NOTE: A value of 128x is the most sensitive setting available. At the most sensitivity settings, the MSB of the Delta Count register represents 64 out of ~25,000 which corresponds to a touch of approximately 0.25% of the base capacitance (or a ΔC of 25fF from a 10pF base capacitance). Conversely a value of 1x is the least sensitive setting available. At these settings, the MSB of the Delta Count register corresponds to a delta count of 8192 counts out of ~25,000 which corresponds to a touch of approximately 33% of the base capacitance (or a ΔC of 3.33pF from a 10pF base capacitance).

Table 5.41 STBY_SENSE Bit Decode

STBY_SENSE[2:0]			SENSITIVITY MULTIPLIER
2	1	0	
0	0	0	128x (most sensitive)
0	0	1	64x

Table 5.41 STBY_SENSE Bit Decode (continued)

STBY_SENSE[2:0]			SENSITIVITY MULTIPLIER
2	1	0	
0	1	0	32x (default)
0	1	1	16x
1	0	0	8x
1	0	1	4x
1	1	0	2x
1	1	1	1x - (least sensitive)

5.23 Standby Threshold Register

Table 5.42 Standby Threshold Register

ADDR	R/W	REGISTER	B7	B6	B5	B4	B3	B2	B1	B0	DEFAULT
43h	R/W	Standby Threshold	-	64	32	16	8	4	2	1	40h

The Standby Threshold register stores the delta threshold that is used to determine if a touch has been detected. When a touch occurs, the input signal of the corresponding sensor pad changes due to the capacitance associated with a touch. If the sensor input change exceeds the threshold settings, a touch is detected.

5.24 Sensor Input Base Count Registers

Table 5.43 Sensor Input Base Count Registers

ADDR	R/W	REGISTER	B7	B6	B5	B4	B3	B2	B1	B0	DEFAULT
50h	R	Sensor Input 1 Base Count	128	64	32	16	8	4	2	1	C8h
51h	R	Sensor Input 2 Base Count	128	64	32	16	8	4	2	1	C8h
52h	R	Sensor Input 3 Base Count	128	64	32	16	8	4	2	1	C8h

The Sensor Input Base Count registers store the calibrated “Not Touched” input value from the capacitive touch sensor inputs. These registers are periodically updated by the re-calibration routine.

The routine uses an internal adder to add the current count value for each reading to the sum of the previous readings until sample size has been reached. At this point, the upper 16 bits are taken and used as the Sensor Input Base Count. The internal adder is then reset and the re-calibration routine continues.

The data presented is determined by the BASE_SHIFT[3:0] bits (see [Section 5.5](#)).

5.25 LED Output Type Register

Table 5.44 LED Output Type Register

ADDR	R/W	REGISTER	B7	B6	B5	B4	B3	B2	B1	B0	DEFAULT
71h	R/W	LED Output Type	-	-	-	-	-	LED3_OT	LED2_OT	LED1_OT	00h

The LED Output Type register controls the type of output for the LED pins. Each pin is controlled by a single bit. Refer to application note 21.4 CAP1188 Family LED Configuration Options for more information about implementing LEDs.

Bit 2 - LED3_OT - Determines the output type of the LED3 pin.

- '0' (default) - The LED3 pin is an open-drain output with an external pull-up resistor. When the appropriate pin is set to the "active" state (logic '1'), the pin will be driven low. Conversely, when the pin is set to the "inactive" state (logic '0'), the pin will be left in a High Z state and pulled high via an external pull-up resistor.
- '1' - The LED3 pin is a push-pull output. When driving a logic '1', the pin is driven high. When driving a logic '0', the pin is driven low.

Bit 1 - LED2_OT - Determines the output type of the LED2 pin.

Bit 0 - LED1_OT - Determines the output type of the LED1 pin.

5.26 Sensor Input LED Linking Register

Table 5.45 Sensor Input LED Linking Register

ADDR	R/W	REGISTER	B7	B6	B5	B4	B3	B2	B1	B0	DEFAULT
72h	R/W	Sensor Input LED Linking	-	-	-	-	-	CS3_LED3	CS2_LED2	CS1_LED1	00h

The Sensor Input LED Linking register controls whether a capacitive touch sensor input is linked to an LED output. If the corresponding bit is set, then the appropriate LED output will change states defined by the LED Behavior controls (see [Section 5.31](#)) in response to the capacitive touch sensor input.

Bit 2 - CS3_LED3 - Links the LED3 output to a detected touch on the CS3 sensor input. When a touch is detected, the LED is actuated and will behave as determined by the LED Behavior controls.

- '0' (default) - The LED 3 output is not associated with the CS3 input. If a touch is detected on the CS3 input, the LED will not automatically be actuated. The LED is enabled and controlled via the LED Output Control register (see [Section 5.28](#)) and the LED Behavior registers (see [Section 5.31](#)).
- '1' - The LED 3 output is associated with the CS3 input. If a touch is detected on the CS3 input, the LED will be actuated and behave as defined in [Table 5.52](#).

Bit 1 - CS2_LED2 - Links the LED2 output to a detected touch on the CS2 sensor input. When a touch is detected, the LED is actuated and will behave as determined by the LED Behavior controls.

Bit 0 - CS1_LED1 - Links the LED1 output to a detected touch on the CS1 sensor input. When a touch is detected, the LED is actuated and will behave as determined by the LED Behavior controls.

5.27 LED Polarity Register

Table 5.46 LED Polarity Register

ADDR	R/W	REGISTER	B7	B6	B5	B4	B3	B2	B1	B0	DEFAULT
73h	R/W	LED Polarity	-	-	-	-	-	LED3_POL	LED2_POL	LED1_POL	00h

The LED Polarity register controls the logical polarity of the LED outputs. When these bits are set or cleared, the corresponding LED Mirror controls are also set or cleared (unless the BLK_POL_MIR bit is set - see [Section 5.6, "Configuration Registers"](#)). [Table 5.48, "LED Polarity Behavior"](#) shows the interaction between the polarity controls, output controls, and relative brightness.

APPLICATION NOTE: The polarity controls determine the final LED pin drive. A touch on a linked capacitive touch sensor input is treated in the same way as the LED Output Control bit being set to a logic '1'.

APPLICATION NOTE: The LED drive assumes that the LEDs are configured such that if the LED pin is driven to a logic '0' then the LED will be on and that the CAP1133 LED pin is sinking the LED current. Conversely, if the LED pin is driven to a logic '1', the LED will be off and there is no current flow. See Figure 4.1, "System Diagram for CAP1133".

APPLICATION NOTE: This application note applies when the LED polarity is inverted (LEDx_POL = '0'). For LED operation, the duty cycle settings determine the % of time that the LED pin will be driven to a logic '0' state in. The Max Duty Cycle settings define the maximum % of time that the LED pin will be driven low (i.e. maximum % of time that the LED is **on**) while the Min Duty Cycle settings determine the minimum % of time that the LED pin will be driven low (i.e. minimum % of time that the LED is **on**). When there is no touch detected or the LED Output Control register bit is at a logic '0', the LED output will be driven at the minimum duty cycle setting. Breathe operations will ramp the duty cycle from the minimum duty cycle to the maximum duty cycle.

APPLICATION NOTE: This application note applies when the LED polarity is non-inverted (LEDx_POL = '1'). For LED operation, the duty cycle settings determine the % of time that the LED pin will be driven to a logic '1' state. The Max Duty Cycle settings define the maximum % of time that the LED pin will be driven high (i.e. maximum % of time that the LED is **off**) while the Min Duty Cycle settings determine the minimum % of time that the LED pin will be driven high (i.e. minimum % of time that the LED is **off**). When there is no touch detected or the LED Output Control register bit is at a logic '0', the LED output will be driven at 100 minus the minimum duty cycle setting. Breathe operations will ramp the duty cycle from 100 minus the minimum duty cycle to 100 minus the maximum duty cycle.

APPLICATION NOTE: The LED Mirror controls (see [Section 5.30, "LED Mirror Control Register"](#)) work with the polarity controls with respect to LED brightness but will not have a direct effect on the output pin drive.

Bit 2 - LED3_POL - Determines the polarity of the LED3 output.

- '0' (default) - The LED3 output is inverted. For example, a setting of '1' in the LED Output Control register will cause the LED pin output to be driven to a logic '0'.
- '1' - The LED3 output is non-inverted. For example, a setting of '1' in the LED Output Control register will cause the LED pin output to be driven to a logic '1' or left in the high-z state as determined by its output type

Bit 1 - LED2_POL - Determines the polarity of the LED2 output.

Bit 0 - LED1_POL - Determines the polarity of the LED1 output.

5.28 LED Output Control Register

Table 5.47 LED Output Control Register

ADDR	R/W	REGISTER	B7	B6	B5	B4	B3	B2	B1	B0	DEFAULT
74h	R/W	LED Output Control	-	-	-	-	-	LED3_DR	LED2_DR	LED1_DR	00h

The LED Output Control Register controls the output state of the LED pins that are not linked to sensor inputs.

Note: If an LED is linked to a sensor input in the Sensor Input LED Linking Register ([Section 5.26, "Sensor Input LED Linking Register"](#)), the corresponding bit in the LED Output Control Register is ignored (i.e. a linked LED cannot be host controlled).

The LED Polarity Control Register will determine the non actuated state of the LED pins. The actuated LED behavior is determined by the LED behavior controls (see [Section 5.31, "LED Behavior Register"](#)).

[Table 5.48](#) shows the interaction between the polarity controls, output controls, and relative brightness.

Bit 2 - LED3_DR - Determines whether LED3 output is driven high or low.

- '0' (default) - The LED3 output is driven at the minimum duty cycle or not actuated.
- '1' - The LED3 output is driven at the maximum duty cycle or is actuated.

Bit 1 - LED2_DR - Determines whether LED2 output is driven high or low.

Bit 0 - LED1_DR - Determines whether LED1 output is driven high or low.

Table 5.48 LED Polarity Behavior

LED OUTPUT CONTROL REGISTER OR TOUCH	POLARITY	MAX DUTY	MIN DUTY	BRIGHTNESS	LED APPEARANCE
0	inverted ('0')	not used	minimum % of time that the LED is on (logic 0)	maximum brightness at min duty cycle	on at min duty cycle
1	inverted ('0')	maximum % of time that the LED is on (logic 0)	minimum % of time that the LED is on (logic 0)	maximum brightness at max duty cycle. Brightness ramps from min duty cycle to max duty cycle	according to LED behavior
0	non-inverted ('1')	not used	minimum % of time that the LED is off (logic 1)	maximum brightness at 100 minus min duty cycle.	on at 100 - min duty cycle

Table 5.48 LED Polarity Behavior (continued)

LED OUTPUT CONTROL REGISTER OR TOUCH	POLARITY	MAX DUTY	MIN DUTY	BRIGHTNESS	LED APPEARANCE
1	non-inverted ('1')	maximum % of time that the LED is off (logic 1)	minimum % of time that the LED is off (logic 1)	For Direct behavior, maximum brightness is 100 minus max duty cycle. When breathing, max brightness is 100 minus min duty cycle. Brightness ramps from 100 - min duty cycle to 100 - max duty cycle.	according to LED behavior

5.29 Linked LED Transition Control Register

Table 5.49 Linked LED Transition Control Register

ADDR	R/W	REGISTER	B7	B6	B5	B4	B3	B2	B1	B0	DEFAULT
77h	R/W	Linked LED Transition Control	-	-	-	-	-	LED3_LTRAN	LED2_LTRAN	LED1_LTRAN	00h

The Linked LED Transition Control register controls the LED drive when the LED is linked to a capacitive touch sensor input. These controls work in conjunction with the INV_LINK_TRAN bit (see [Section 5.6.2, "Configuration 2 - 44h"](#)) to create smooth transitions from host control to linked LEDs.

Bit 2 - LED3_LTRAN - Determines the transition effect when LED3 is linked to CS3.

- '0' (default) - When the LED output control bit for CS3 is '1', and then CS3 is linked to LED3 and no touch is detected, the LED will change states.
- '1' - If the INV_LINK_TRAN bit is '1', when the LED output control bit for CS3 is '1', and then CS3 is linked to LED3 and no touch is detected, the LED will not change states. In addition, the LED state will change when the sensor pad is touched. If the INV_LINK_TRAN bit is '0', when the LED output control bit for CS3 is '1', and then CS3 is linked to LED3 and no touch is detected, the LED will not change states. However, the LED state will not change when the sensor pad is touched.

APPLICATION NOTE: If the LED behavior is not "Direct" and the INV_LINK_TRAN bit is '0', the LED will not perform as expected when the LED3_LTRAN bit is set to '1'. Therefore, if breathe and pulse behaviors are used, set the INV_LINK_TRAN bit to '1'.

Bit 1 - LED2_LTRAN - Determines the transition effect when LED2 is linked to CS2.

Bit 0 - LED1_LTRAN - Determines the transition effect when LED1 is linked to CS1.

5.30 LED Mirror Control Register

Table 5.50 LED Mirror Control Register

ADDR	R/W	REGISTER	B7	B6	B5	B4	B3	B2	B1	B0	DEFAULT
79h	R/W	LED Mirror Control	-	-	-	-	-	LED3_MIR_EN	LED2_MIR_EN	LED1_MIR_EN	00h

The LED Mirror Control Registers determine the meaning of duty cycle settings when polarity is non-inverted for each LED channel. When the polarity bit is set to '1' (non-inverted), to obtain correct steps for LED ramping, pulse, and breathe behaviors, the min and max duty cycles need to be relative to 100%, rather than the default, which is relative to 0%.

APPLICATION NOTE: The LED drive assumes that the LEDs are configured such that if the LED pin is driven to a logic '0', the LED will be on and the CAP1133 LED pin is sinking the LED current. When the polarity bit is set to '1', it is considered non-inverted. For systems using the opposite LED configuration, mirror controls would apply when the polarity bit is '0'.

These bits are changed automatically if the corresponding LED Polarity bit is changed (unless the BLK_POL_MIR bit is set - see [Section 5.6](#)).

Bit 2 - LED3_MIR_EN - Determines whether the duty cycle settings are “biased” relative to 0% or 100% duty cycle.

- '0' (default) - The duty cycle settings are determined relative to 0% and are determined directly with the settings.
- '1' - The duty cycle settings are determined relative to 100%.

Bit 1 - LED2_MIR_EN - Determines whether the duty cycle settings are “biased” relative to 0% or 100% duty cycle.

Bit 0 - LED1_MIR_EN - Determines whether the duty cycle settings are “biased” relative to 0% or 100% duty cycle.

5.31 LED Behavior Register

Table 5.51 LED Behavior Register

ADDR	R/W	REGISTER	B7	B6	B5	B4	B3	B2	B1	B0	DEFAULT
81h	R/W	LED Behavior 1	-	-	LED3_CTL[1:0]	LED2_CTL[1:0]	LED1_CTL[1:0]				00h

The LED Behavior register controls the operation of LEDs. Each LED pin is controlled by a 2-bit field and the behavior is determined by whether the LED is linked to a capacitive touch sensor input or not.

If the corresponding LED output is linked to a capacitive touch sensor input, the appropriate behavior will be enabled / disabled based on touches and releases.

If the LED output is not associated with a capacitive touch sensor input, the appropriate behavior will be enabled / disabled by the LED Output Control register. If the respective LEDx_DR bit is set to a logic '1', this will be associated as a “touch”, and if the LEDx_DR bit is set to a logic '0', this will be associated as a “release”.

Table 5.52, "LEDx_CTL Bit Decode" shows the behavior triggers. The defined behavior will activate when the Start Trigger is met and will stop when the Stop Trigger is met. Note the behavior of the Breathe Hold and Pulse Release option.

The LED Polarity Control register will determine the non actuated state of the LED outputs (see Section 5.27, "LED Polarity Register").

APPLICATION NOTE: If an LED is not linked to a capacitive touch sensor input and is breathing (via the Breathe or Pulse behaviors), it must be unactuated and then re-actuated before changes to behavior are processed. For example, if the LED output is breathing and the Maximum duty cycle is changed, this change will not take effect until the LED output control register is set to '0' and then re-set to '1'.

APPLICATION NOTE: If an LED is not linked to the capacitive touch sensor input and configured to operate using Pulse 1 Behavior, then the circuitry will only be actuated when the corresponding output control bit is set. It will not check the bit condition until the Pulse 1 behavior is finished. The device will not remember if the bit was cleared and reset while it was actuated.

APPLICATION NOTE: If an LED is actuated and not linked and the desired LED behavior is changed, this new behavior will take effect immediately; however, the first instance of the changed behavior may act incorrectly (e.g. if changed from Direct to Pulse 1, the LED output may 'breathe' 4 times and then end at minimum duty cycle). LED Behaviors will operate normally once the LED has been un-actuated and then re-actuated.

APPLICATION NOTE: If an LED is actuated and it is switched from linked to a capacitive touch sensor input to unlinked (or vice versa), the LED will respond to the new command source immediately if the behavior was Direct or Breathe. For Pulse behaviors, it will complete the behavior already in progress. For example, if a linked LED was actuated by a touch and the control is changed so that it is unlinked, it will check the status of the corresponding LED Output Control bit. If that bit is '0', then the LED will behave as if a release was detected. Likewise, if an unlinked LED was actuated by the LED Output Control register and the control is changed so that it is linked and no touch is detected, then the LED will behave as if a release was detected.

Bits 5 - 4 - LED3_CTL[1:0] - Determines the behavior of LED3 as shown in Table 5.52.

Bits 3 - 2 - LED2_CTL[1:0] - Determines the behavior of LED2 as shown in Table 5.52.

Bits 1 - 0 - LED1_CTL[1:0] - Determines the behavior of LED1 as shown in Table 5.52.

Table 5.52 LEDx_CTL Bit Decode

LEDX_CTL [1:0]		OPERATION	DESCRIPTION	START TRIGGER	STOP TRIGGER
1	0				
0	0	Direct	The LED is driven to the programmed state (active or inactive). See Figure 5.7	Touch Detected or LED Output Control bit set	Release Detected or LED Output Control bit cleared
0	1	Pulse 1	The LED will "Pulse" a programmed number of times. During each "Pulse" the LED will breathe up to the maximum brightness and back down to the minimum brightness so that the total "Pulse" period matches the programmed value.	Touch or Release Detected or LED Output Control bit set or cleared (see Section 5.32)	n/a

Table 5.52 LEDx_CTL Bit Decode (continued)

LEDX_CTL [1:0]		OPERATION	DESCRIPTION	START TRIGGER	STOP TRIGGER
1	0				
1	0	Pulse 2	The LED will "Pulse" when the start trigger is detected. When the stop trigger is detected, it will "Pulse" a programmable number of times then return to its minimum brightness.	Touch Detected or LED Output Control bit set	Release Detected or LED Output Control bit cleared
1	1	Breathe	The LED will breathe. It will be driven with a duty cycle that ramps up from the programmed minimum duty cycle (default 0%) to the programmed maximum duty cycle (default 100%) and then back down. Each ramp takes up 50% of the programmed period. The total period of each "breath" is determined by the LED Breathe Period controls - see Section 5.34 .	Touch Detected or LED Output Control bit set	Release Detected or LED Output Control bit cleared

APPLICATION NOTE: The PWM frequency is determined based on the selected LED behavior, the programmed breathe period, and the programmed min and max duty cycles. For the Direct behavior mode, the PWM frequency is calculated based on the programmed Rise and Fall times. If these are set at 0, then the maximum PWM frequency will be used based on the programmed duty cycle settings.

5.32 LED Pulse 1 Period Register

Table 5.53 LED Pulse 1 Period Register

ADDR	R/W	REGISTER	B7	B6	B5	B4	B3	B2	B1	B0	DEFAULT
84h	R/W	LED Pulse 1 Period	ST_TRIG	P1_PER6	P1_PER5	P1_PER4	P1_PER3	P1_PER2	P1_PER1	P1_PER0	20h

The LED Pulse Period 1 register determines the overall period of a pulse operation as determined by the LED_CTL registers (see [Table 5.52](#) - setting 01b). The LSB represents 32ms so that a setting of 18h (24d) would represent a period of 768ms (24 x 32ms = 768ms). The total range is from 32ms to 4.064 seconds as shown in [Table 5.54](#) with the default being 1024ms.

APPLICATION NOTE: Due to constraints on the LED Drive PWM operation, any Breathe Period less than 160ms (05h) may not be achievable. The device will breathe at the minimum period possible as determined by the period and min / max duty cycle settings.

Bit 7 - ST_TRIG - Determines the start trigger for the LED Pulse behavior.

- '0' (default) - The LED will Pulse when a touch is detected or the drive bit is set.
- '1' - The LED will Pulse when a release is detected or the drive bit is cleared.

The Pulse 1 operation is shown in [Figure 5.1](#) when the LED output is configured for non-inverted polarity (LEDx_POL = 1) and in [Figure 5.2](#) for inverted polarity (LEDx_POL = 0).

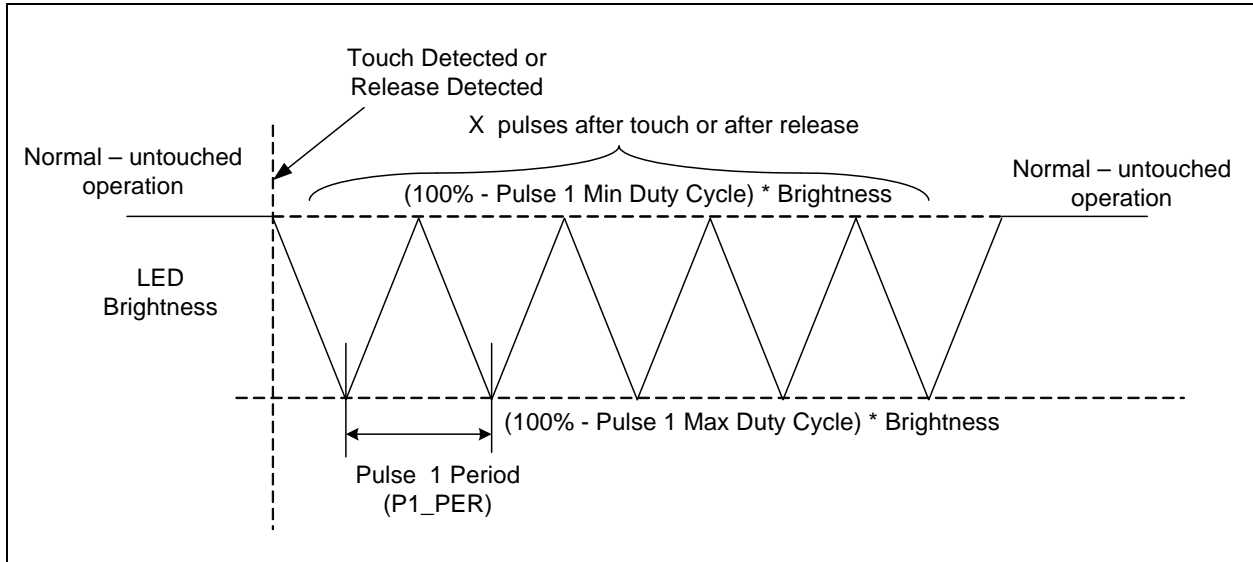

Figure 5.1 Pulse 1 Behavior with Non-Inverted Polarity

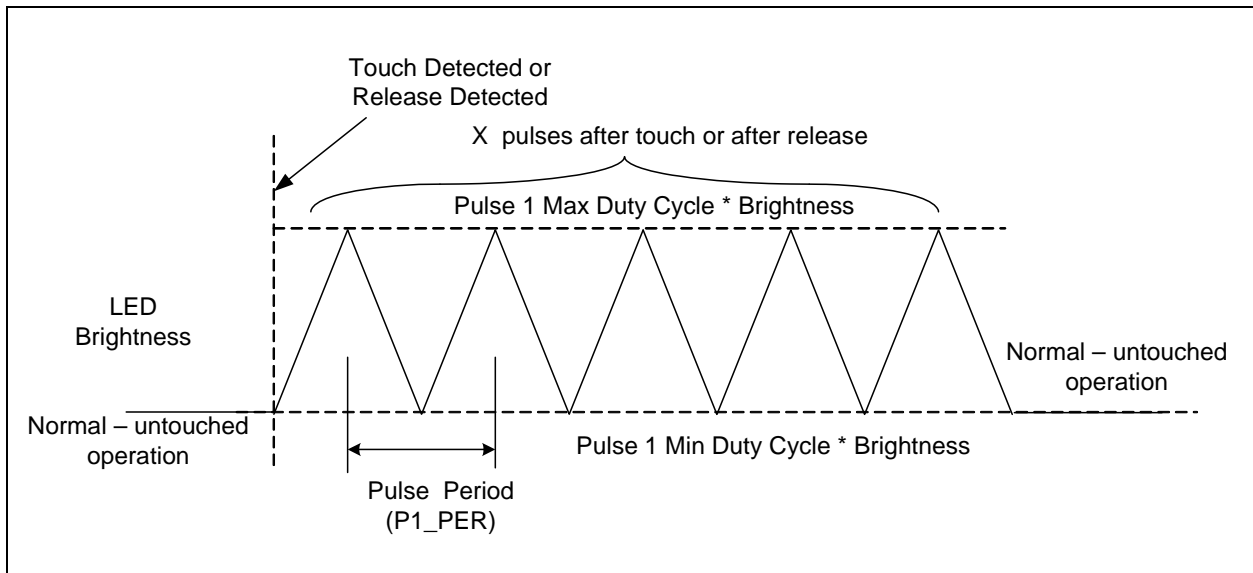

Figure 5.2 Pulse 1 Behavior with Inverted Polarity

Table 5.54 LED Pulse / Breathe Period Example

SETTING (HEX)	SETTING (DECIMAL)	TOTAL BREATHE / PULSE PERIOD (MS)
00h	0	32
01h	1	32
02h	2	64

Table 5.54 LED Pulse / Breathe Period Example (continued)

SETTING (HEX)	SETTING (DECIMAL)	TOTAL BREATHE / PULSE PERIOD (MS)
03h	3	96
...
7Dh	125	4000
7Eh	126	4032
7Fh	127	4064

5.33 LED Pulse 2 Period Register

Table 5.55 LED Pulse 2 Period Register

ADDR	R/W	REGISTER	B7	B6	B5	B4	B3	B2	B1	B0	DEFAULT
85h	R/W	LED Pulse 2 Period	-	P2_PER6	P2_PER5	P2_PER4	P2_PER3	P2_PER2	P2_PER1	P2_PER0	14h

The LED Pulse 2 Period register determines the overall period of a pulse operation as determined by the LED_CTL registers (see Table 5.52 - setting 10b). The LSB represents 32ms so that a setting of 18h (24d) would represent a period of 768ms. The total range is from 32ms to 4.064 seconds (see Table 5.54) with a default of 640ms.

APPLICATION NOTE: Due to constraints on the LED Drive PWM operation, any Breathe Period less than 160ms (05h) may not be achievable. The device will breathe at the minimum period possible as determined by the period and min / max duty cycle settings.

The Pulse 2 Behavior is shown in Figure 5.3 for non-inverted polarity (LEDx_POL = 1) and in Figure 5.4 for inverted polarity (LEDx_POL = 0).

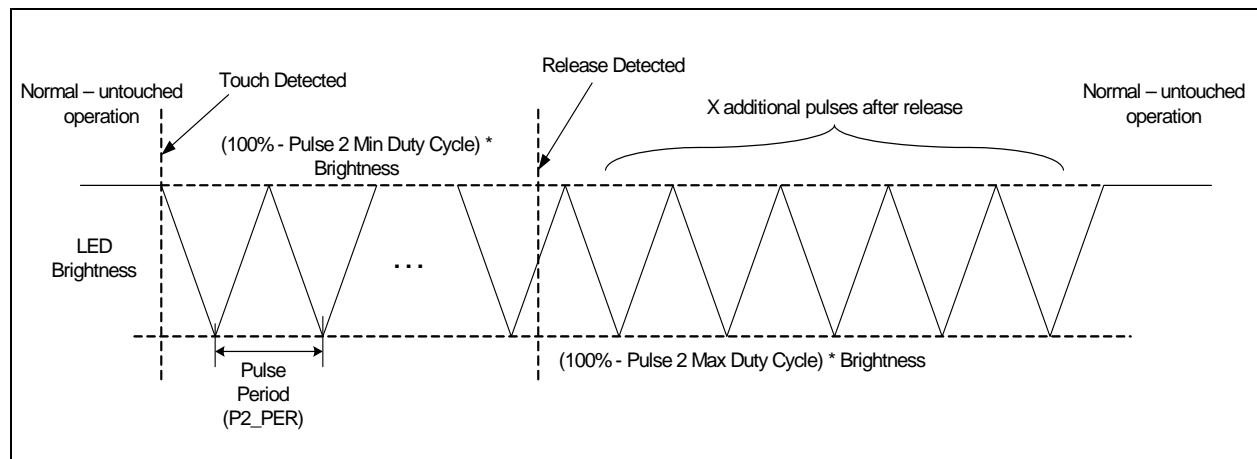

Figure 5.3 Pulse 2 Behavior with Non-Inverted Polarity

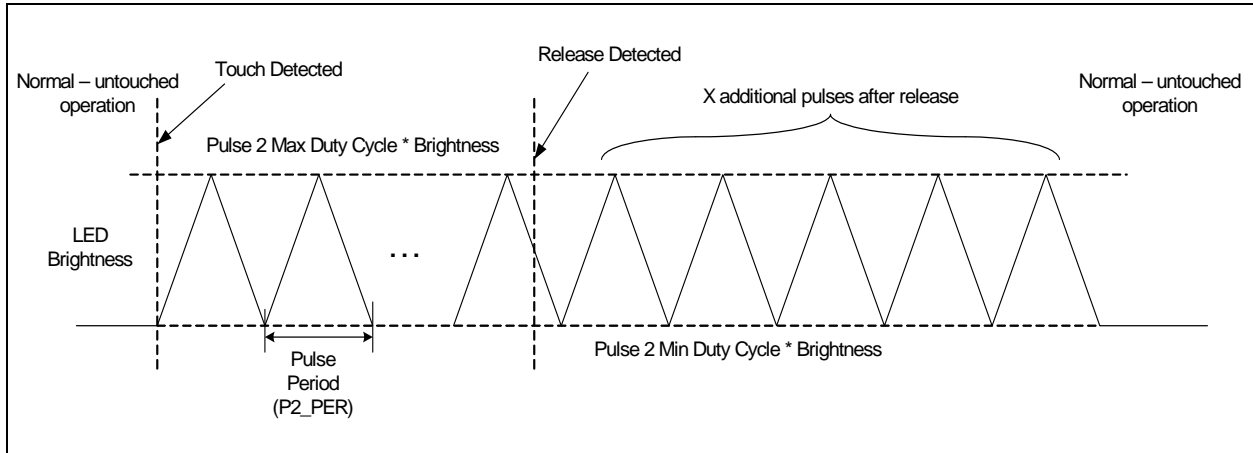

Figure 5.4 Pulse 2 Behavior with Inverted Polarity

5.34 LED Breathe Period Register

Table 5.56 LED Breathe Period Register

ADDR	R/W	REGISTER	B7	B6	B5	B4	B3	B2	B1	B0	DEFAULT
86h	R/W	LED Breathe Period	-	BR_PER6	BR_PER5	BR_PER4	BR_PER3	BR_PER2	BR_PER1	BR_PER0	5Dh

The LED Breathe Period register determines the overall period of a breathe operation as determined by the LED_CTL registers (see Table 5.52 - setting 11b). The LSB represents 32ms so that a setting of 18h (24d) would represent a period of 768ms. The total range is from 32ms to 4.064 seconds (see Table 5.54) with a default of 2976ms.

APPLICATION NOTE: Due to constraints on the LED Drive PWM operation, any Breathe Period less than 160ms (05h) may not be achievable. The device will breathe at the minimum period possible as determined by the period and min / max duty cycle settings.

5.35 LED Configuration Register

Table 5.57 LED Configuration Register

ADDR	R/W	REGISTER	B7	B6	B5	B4	B3	B2	B1	B0	DEFAULT
88h	R/W	LED Config	-	RAMP_ALERT	PULSE2_CNT[2:0]			PULSE1_CNT[2:0]			04h

The LED Configuration register controls general LED behavior as well as the number of pulses that are sent for the PULSE LED output behavior.

Bit 6 - RAMP_ALERT - Determines whether the device will assert the ALERT# pin when LEDs actuated by the LED Output Control register bits have finished their respective behaviors. Interrupts will only be generated if the LED activity is generated by writing the LED Output Control registers. Any LED activity associated with touch detection will not cause an interrupt to be generated when the LED behavior has been finished.

Datasheet

- '0' (default) - The ALERT# pin will not be asserted when LEDs actuated by the LED Output Control register have finished their programmed behaviors.
- '1' - The ALERT# pin will be asserted whenever any LED that is actuated by the LED Output Control register has finished its programmed behavior.

Bits 5 - 3 - PULSE2_CNT[2:0] - Determines the number of pulses used for the Pulse 2 behavior as shown in [Table 5.58](#).

Bits 2 - 0 - PULSE1_CNT[2:0] - Determines the number of pulses used for the Pulse 1 behavior as shown in [Table 5.58](#).

Table 5.58 PULSEX_CNT Decode

PULSEX_CNT[2:0]			NUMBER OF BREATHS
2	1	0	
0	0	0	1 (default - Pulse 2)
0	0	1	2
0	1	0	3
0	1	1	4
1	0	0	5 (default - Pulse 1)
1	0	1	6
1	1	0	7
1	1	1	8

5.36 LED Duty Cycle Registers

Table 5.59 LED Duty Cycle Registers

ADDR	R/W	REGISTER	B7	B6	B5	B4	B3	B2	B1	B0	DEFAULT
90h	R/W	LED Pulse 1 Duty Cycle	P1_MAX_DUTY[3:0]				P1_MIN_DUTY[3:0]				F0h
91h	R/W	LED Pulse 2 Duty Cycle	P2_MAX_DUTY[3:0]				P2_MIN_DUTY[3:0]				F0h
92h	R/W	LED Breathe Duty Cycle	BR_MAX_DUTY[3:0]				BR_MIN_DUTY[3:0]				F0h
93h	R/W	Direct Duty Cycle	DR_MAX_DUTY[3:0]				DR_MIN_DUTY[3:0]				F0h

The LED Duty Cycle registers determine the minimum and maximum duty cycle settings used for the LED for each LED behavior. These settings affect the brightness of the LED when it is fully off and fully on.

The LED driver duty cycle will ramp up from the minimum duty cycle to the maximum duty cycle and back down again.

APPLICATION NOTE: When operating in Direct behavior mode, changes to the Duty Cycle settings will be applied immediately. When operating in Breathe, Pulse 1, or Pulse 2 modes, the LED must be unactuated and then re-actuated before changes to behavior are processed.

Bits 7 - 4 - X_MAX_DUTY[3:0] - Determines the maximum PWM duty cycle for the LED drivers as shown in [Table 5.60](#).

Bits 3 - 0 - X_MIN_DUTY[3:0] - Determines the minimum PWM duty cycle for the LED drivers as shown in [Table 5.60](#).

Table 5.60 LED Duty Cycle Decode

X_MAX/MIN_DUTY [3:0]				MAXIMUM DUTY CYCLE	MINIMUM DUTY CYCLE
3	2	1	0		
0	0	0	0	7%	0%
0	0	0	1	9%	7%
0	0	1	0	11%	9%
0	0	1	1	14%	11%
0	1	0	0	17%	14%
0	1	0	1	20%	17%
0	1	1	0	23%	20%
0	1	1	1	26%	23%
1	0	0	0	30%	26%
1	0	0	1	35%	30%
1	0	1	0	40%	35%
1	0	1	1	46%	40%
1	1	0	0	53%	46%
1	1	0	1	63%	53%
1	1	1	0	77%	63%
1	1	1	1	100%	77%

5.37 LED Direct Ramp Rates Register

Table 5.61 LED Direct Ramp Rates Register

ADDR	R/W	REGISTER	B7	B6	B5	B4	B3	B2	B1	B0	DEFAULT
94h	R/W	LED Direct Ramp Rates	-	-	RISE_RATE[2:0]			FALL_RATE[2:0]			00h

The LED Direct Ramp Rates register control the rising and falling edge time of an LED that is configured to operate in Direct behavior mode. The rising edge time corresponds to the amount of time the LED takes to transition from its minimum duty cycle to its maximum duty cycle. Conversely, the

Datasheet

falling edge time corresponds to the amount of time that the LED takes to transition from its maximum duty cycle to its minimum duty cycle.

Bits 5 - 3 - RISE_RATE[2:0] - Determines the rising edge time of an LED when it transitions from its minimum drive state to its maximum drive state as shown in [Table 5.62](#).

Bits 2 - 0 - FALL_RATE[2:0] - Determines the falling edge time of an LED when it transitions from its maximum drive state to its minimum drive state as shown in [Table 5.62](#).

Table 5.62 Rise / Fall Rate Decode

RISE_RATE/ FALL_RATE/ BIT DECODE			RISE / FALL TIME (T _{RISE} / T _{FALL})
2	1	0	
0	0	0	0
0	0	1	250ms
0	1	0	500ms
0	1	1	750ms
1	0	0	1s
1	0	1	1.25s
1	1	0	1.5s
1	1	1	2s

5.38 LED Off Delay Register

Table 5.63 LED Off Delay Register

ADDR	R/W	REGISTER	B7	B6	B5	B4	B3	B2	B1	B0	DEFAULT
95h	R/W	LED Off Delay Register	-	BR_OFF_DLY[2:0]			DIR_OFF_DLY[3:0]				00h

The LED Off Delay register determines the amount of time that an LED remains at its maximum duty cycle (or minimum as determined by the polarity controls) before it starts to ramp down. If the LED is operating in Breathe mode, this delay is applied at the top of each “breath”. If the LED is operating in the Direct mode, this delay is applied when the LED is unactuated.

Bits 6 - 4 - BR_OFF_DLY[2:0] - Determines the Breathe behavior mode off delay, which is the amount of time an LED in Breathe behavior mode remains inactive after it finishes a breathe pulse (ramp on and ramp off), as shown in [Figure 5.5](#) (non-inverted polarity LED_x_POL = 1) and [Figure 5.6](#) (inverted polarity LED_x_POL = 0). Available settings are shown in [Table 5.64](#).

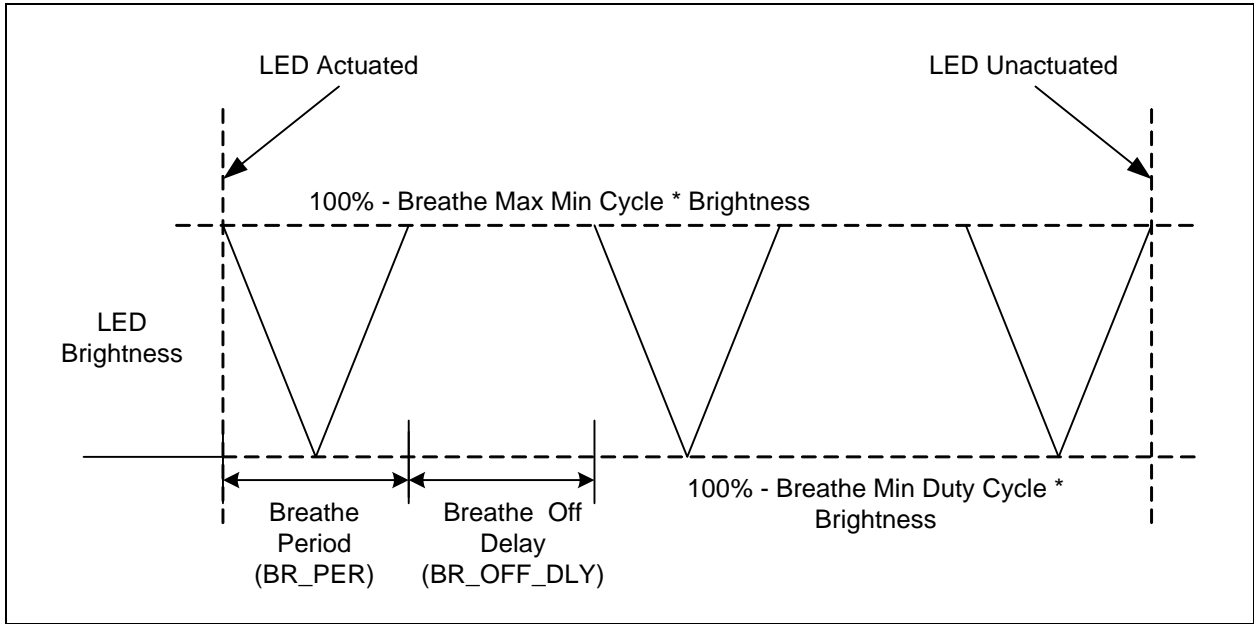

Figure 5.5 Breathe Behavior with Non-Inverted Polarity

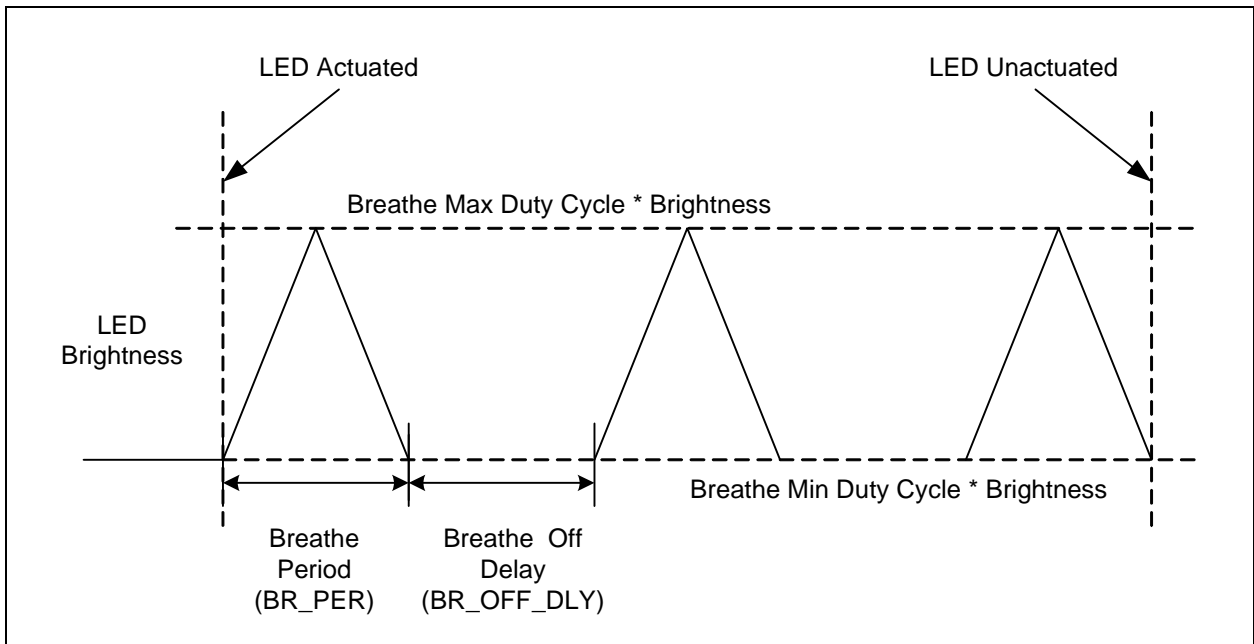

Figure 5.6 Breathe Behavior with Inverted Polarity

Table 5.64 Breathe Off Delay Settings

BR_OFF_DLY [2:0]			OFF DELAY
2	1	0	
0	0	0	0 (default)
0	0	1	0.25s
0	1	0	0.5s
0	1	1	0.75s
1	0	0	1.0s
1	0	1	1.25s
1	1	0	1.5s
1	1	1	2.0s

Bits 3 - 0 - DIR_OFF_DLY[3:0] - Determines the turn-off delay, as shown in Table 5.65, for all LEDs that are configured to operate in Direct behavior mode.

The Direct behavior operation is determined by the combination of programmed Rise Time, Fall Time, Min and Max Duty cycles, Off Delay, and polarity. Figure 5.7 shows the behavior for non-inverted polarity (LEDx_POL = 1) while Figure 5.8 shows the behavior for inverted polarity (LEDx_POL = 0).

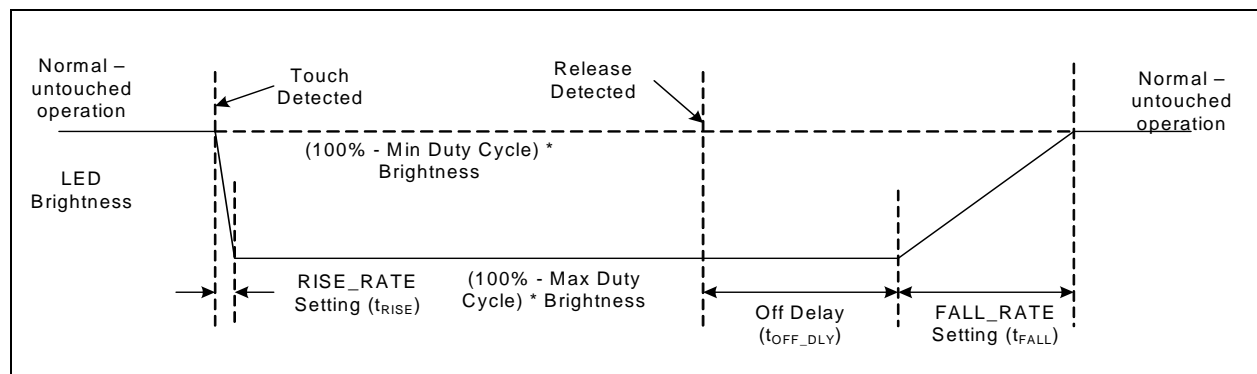

Figure 5.7 Direct Behavior for Non-Inverted Polarity

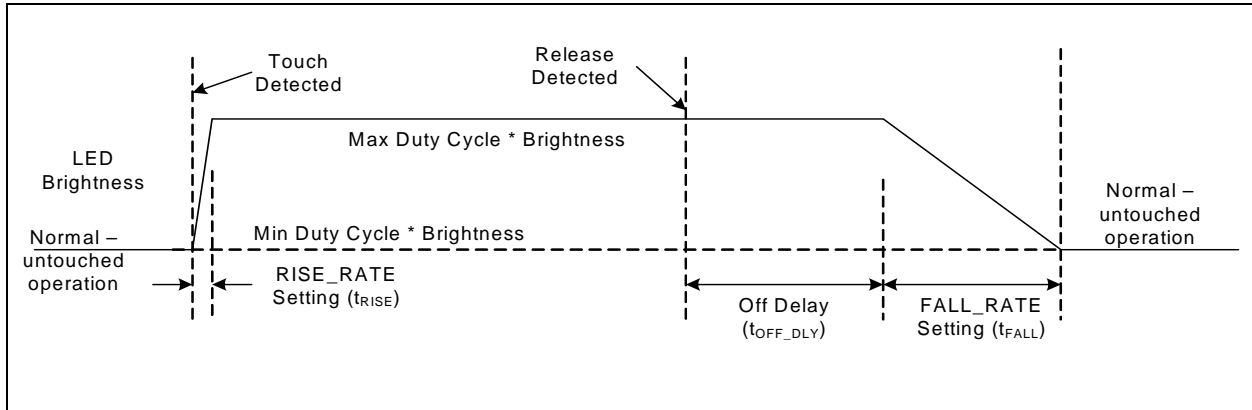

Figure 5.8 Direct Behavior for Inverted Polarity

Table 5.65 Off Delay Decode

OFF DELAY[3:0] BIT DECODE				OFF DELAY (T _{OFF_DLY})
3	2	1	0	
0	0	0	0	0
0	0	0	1	250ms
0	0	1	0	500ms
0	0	1	1	750ms
0	1	0	0	1s
0	1	0	1	1.25s
0	1	1	0	1.5s
0	1	1	1	2s
1	0	0	0	2.5s
1	0	0	1	3.0s
1	0	1	0	3.5s
1	0	1	1	4.0s
1	1	0	0	4.5s
All others				5.0s

5.39 Sensor Input Calibration Registers

Table 5.66 Sensor Input Calibration Registers

ADDR	REGISTER	R/W	B7	B6	B5	B4	B3	B2	B1	B0	DEFAULT
B1h	Sensor Input 1 Calibration	R	CAL1_9	CAL1_8	CAL1_7	CAL1_6	CAL1_5	CAL1_4	CAL1_3	CAL1_2	00h
B2h	Sensor Input 2 Calibration	R	CAL2_9	CAL2_8	CAL2_7	CAL2_6	CAL2_5	CAL2_4	CAL2_3	CAL2_2	00h
B3h	Sensor Input 3 Calibration	R	CAL3_9	CAL3_8	CAL3_7	CAL3_6	CAL3_5	CAL3_4	CAL3_3	CAL3_2	00h
B9h	Sensor Input Calibration LSB 1	R	-	-	CAL3_1	CAL3_0	CAL2_1	CAL2_0	CAL1_1	CAL1_0	00h

The Sensor Input Calibration registers hold the 10-bit value that represents the last calibration value.

5.40 Product ID Register

Table 5.67 Product ID Register

ADDR	R/W	REGISTER	B7	B6	B5	B4	B3	B2	B1	B0	DEFAULT
FDh	R	Product ID	0	1	0	1	0	1	0	0	54h

The Product ID register stores a unique 8-bit value that identifies the device.

5.41 Manufacturer ID Register

Table 5.68 Vendor ID Register

ADDR	R/W	REGISTER	B7	B6	B5	B4	B3	B2	B1	B0	DEFAULT
FEh	R	Manufacturer ID	0	1	0	1	1	1	0	1	5Dh

The Vendor ID register stores an 8-bit value that represents SMSC.

5.42 Revision Register

Table 5.69 Revision Register

ADDR	R/W	REGISTER	B7	B6	B5	B4	B3	B2	B1	B0	DEFAULT
FFh	R	Revision	1	0	0	0	0	0	1	1	83h

The Revision register stores an 8-bit value that represents the part revision.

Chapter 6 Package Information

6.1 CAP1133 Package Drawings

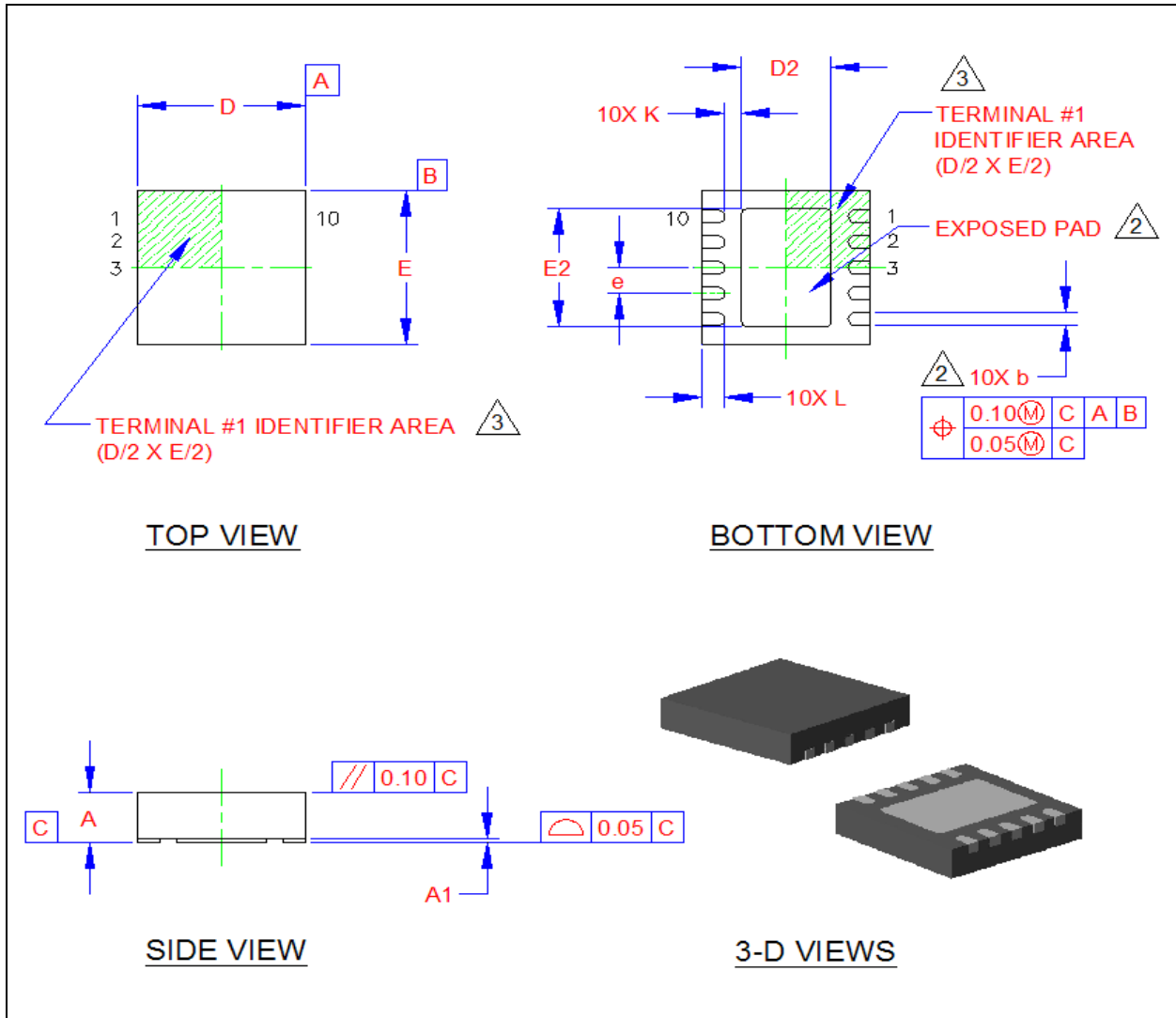

Figure 6.1 10-Pin DFN 3mm x 3mm Package Drawings

COMMON DIMENSIONS					
SYMBOL	MIN	NOM	MAX	NOTE	REMARK
A	0.80	0.85	0.90	-	OVERALL PACKAGE HEIGHT
A1	0	0.02	0.05	-	STANDOFF
D/E	2.90	3.00	3.10	-	X/Y BODY SIZE
D2	1.50	1.60	1.70	2	X EXPOSED PAD SIZE
E2	2.20	2.30	2.40	2	Y EXPOSED PAD SIZE
L	0.35	0.40	0.45	-	TERMINAL LENGTH
b	0.18	0.25	0.30	2	TERMINAL WIDTH
K	0.25	0.30	-	-	TERMINAL TO PAD DISTANCE
e	0.50 BSC			-	TERMINAL PITCH

NOTES:

1. ALL DIMENSIONS ARE IN MILLIMETERS.
2. UNILATERAL COPLANARITY ZONE APPLIES TO THE EXPOSED PAD, AS WELL AS THE TERMINALS. DIMENSIONS "b" APPLIES TO PLATED TERMINALS AND IT IS MEASURED BETWEEN 0.15 AND 0.30 mm FROM THE TERMINAL TIP.
3. DETAILS OF TERMINAL #1 IDENTIFIER ARE OPTIONAL BUT MUST BE LOCATED WITHIN THE AREA INDICATED.

Figure 6.2 10-Pin DFN 3mm x 3mm Package Dimensions

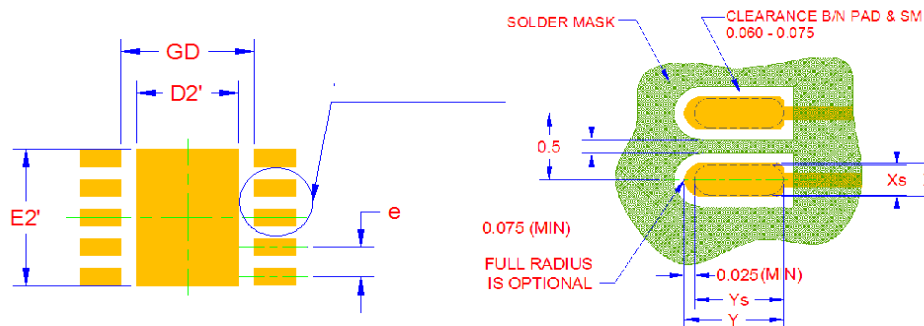

PCB LAND PATTERN

LAND PATTERN DIMENSIONS			
SYMBOL	MIN	NOM	MAX
GD	2.10	-	2.20
D2'	-	1.60	1.60
E2'	-	2.30	-
Pad: X	-	0.28	0.28
Pad: Y	-	0.69	0.69
e	0.50		

Figure 6.3 10-Pin DFN 3mm x 3mm PCB Footprint

6.2 Package Marking

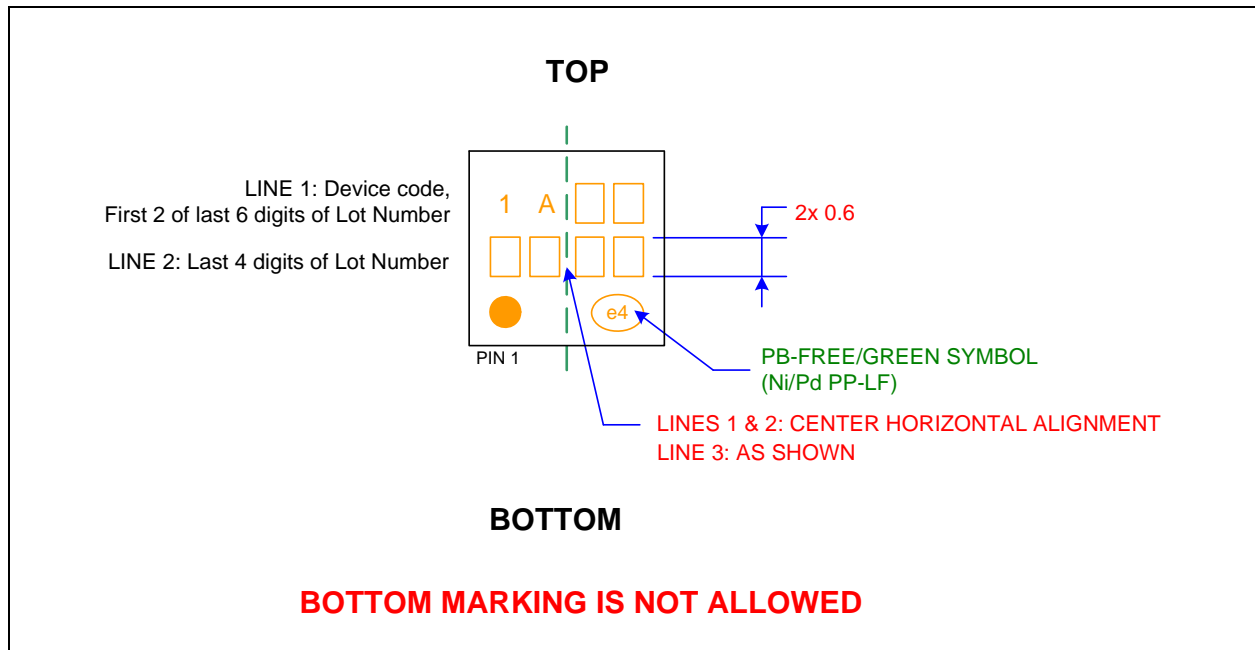

Figure 6.4 CAP1133 Package Marking

Appendix A Device Delta

A.1 Delta from CAP1033 to CAP1133

- Updated circuitry to improve power supply rejection.
- Updated LED driver duty cycle decode values to have more distribution at lower values - closer to a logarithmic curve. See [Table 5.60, "LED Duty Cycle Decode"](#).
- Updated bug that breathe periods were not correct above 2.6s. This includes rise / fall time decodes above 1.5s.
- Added 1 bit to the LED Off Delay register (see [Section 5.38, "LED Off Delay Register"](#)) to extend times from 2s to 5s in 0.5s intervals.
- Breathe behavior modified. A breathe off delay control was added to the LED Off Delay Register (see [Section 5.38, "LED Off Delay Register"](#)) so the LEDs can be configured to remain inactive between breathes.
- Added controls for the LED transition effects when linking LEDs to capacitive sensor inputs. See [Section 5.29, "Linked LED Transition Control Register"](#).
- Added controls to "mirror" the LED duty cycle outputs so that when polarity changes, the LED brightness levels look right. These bits are automatically set when polarity is set. Added control to break this auto-set behavior. See [Section 5.30, "LED Mirror Control Register"](#).
- Added Multiple Touch Pattern detection circuitry. See [Section 5.15, "Multiple Touch Pattern Configuration Register"](#).
- Added General Status register to flag Multiple touches, Multiple Touch Pattern issues and general touch detections. See [Section 5.2, "Status Registers"](#).
- Added bits 6 and 5 to the Recalibration Configuration register (2Dh - see [Section 5.17, "Recalibration Configuration Register"](#)). These bits control whether the accumulation of intermediate data and the consecutive negative delta counts counter are cleared when the noise status bit is set.
- Added Configuration 2 register for LED linking controls, noise detection controls, and control to interrupt on press but not on release. Added control to change alert pin polarity. See [Section 5.6, "Configuration Registers"](#).
- Updated Deep Sleep behavior so that device does not clear DSLEEP bit on received communications but will wake to communicate.
- Changed PWM frequency for LED drivers. The PWM frequency was derived from the programmed breathe period and duty cycle settings and it ranged from ~4Hz to ~8000 Hz. The PWM frequency has been updated to be a fixed value of ~2000Hz.
- Register delta:

Table A.1 Register Delta From CAP1033 to CAP1133

ADDRESS	REGISTER DELTA	DELTA	DEFAULT
00h Page 26	Changed - Main Status / Control	added bits 7-6 to control gain	00h
02h Page 27	New - General Status	new register to store MTP, MULT, LED, and general TOUCH bits	00h

Table A.1 Register Delta From CAP1033 to CAP1133 (continued)

ADDRESS	REGISTER DELTA	DELTA	DEFAULT
44h Page 31	New - Configuration 2	new register to control alert polarity, LED touch linking behavior, LED output behavior, and noise detection, and interrupt on release	40h
24h Page 36	Changed - Averaging Control	updated register bits - moved SAMP_AVG[2:0] bits and added SAMP_TIME bit 1. Default changed	39h
2Bh Page 39	New - Multiple Touch Pattern Configuration	new register for Multiple Touch Pattern configuration - enable and threshold settings	80h
2Dh Page 41	New - Multiple Touch Pattern Register	new register for Multiple Touch Pattern detection circuitry - pattern or number of sensor inputs	07h
2Fh Page 41	Changed - Recalibration Configuration	updated register - updated CAL_CFG bit decode to add a 128 averages setting and removed highest time setting. Default changed. Added bit 6 NO_CLR_INTD and bit 5 NO_CLR_NEG.	8Ah
38h Page 43	Changed - Sensor Input Noise Threshold	updated register bits - removed bits 7 - 3 and consolidated all controls into bits 1 - 0. These bits will set the noise threshold for all channels. Default changed	01h
39h	Removed - Noise Threshold Register 2	removed register	n/a
41h Page 44	Changed - Standby Configuration	updated register bits - moved STBY_AVG[2:0] bits and added STBY_TIME bit 1. Default changed	39h
77h Page 51	New - Linked LED Transition Control	new register to control transition effect when LED linked to sensor inputs	00h
79h Page 52	New - LED Mirror Control	new register to control LED output mirroring for brightness control when polarity changed	00h
90h Page 58	Changed - LED Pulse 1 Duty Cycle	changed bit decode to be more logarithmic	F0h
91h Page 58	Changed - LED Pulse 2 Duty Cycle	changed bit decode to be more logarithmic	F0h
92h Page 58	Changed - LED Breathe Duty Cycle	changed bit decode to be more logarithmic	F0h
93h Page 58	Changed - LED Direct Duty Cycle	changed bit decode to be more logarithmic	F0h
95h	Added controls - LED Off Delay	Added bits 6-4 BR_OFF_DLY[2:0] Added bit 3 DIR_OFF_DLY[3]	00h
FDh Page 64	Changed - Product ID	Changed bit decode for CAP1133	54h

Chapter 7 Datasheet Revision History

Table 7.1 Customer Revision History

REVISION LEVEL & DATE	SECTION/FIGURE/ENTRY	CORRECTION
Rev. 1.32 (01-05-12)	Table 2.2, "Electrical Specifications"	Added conditions for $t_{HD:DAT}$.
	Section 3.2.7, "SMBus and I2C Compatibility"	Renamed from "SMBus and I2C Compliance." First paragraph, added last sentence: "For information on using the CAP1133 in an I ² C system, refer to SMSC AN 14.0 SMSC Dedicated Slave Devices in I ² C Systems." Added: CAP1133 supports I ² C fast mode at 400kHz. This covers the SMBus max time of 100kHz.
	Section 5.4, "Sensor Input Delta Count Registers"	Changed negative value cap from FFh to 80h.
Rev. 1.31 (08-18-11)	Section 3.3.3, "SMBus Send Byte"	Added an application note: The Send Byte protocol is not functional in Deep Sleep (i.e., DSLEEP bit is set).
	Section 3.3.4, "SMBus Receive Byte"	Added an application note: The Receive Byte protocol is not functional in Deep Sleep (i.e., DSLEEP bit is set).
	Section 5.2, "Status Registers"	Removed RESET as bit 3 in register 02h.
Rev. 1.3 (05-18-11)	Section 5.42, "Revision Register"	Updated revision ID from 82h to 83h.
	Section 5.2, "Status Registers"	Added RESET as bit 3 in register 02h.
Rev. 1.2 (02-10-11)	Section A.8, "Delta from Rev B (Mask B0) to Rev C (Mask B1)"	Added.
	Table 2.2, "Electrical Specifications"	PSR improvements made in functional revision B. Changed PSR spec from ± 100 typ and ± 200 max counts / V to ± 3 and ± 10 counts / V. Conditions updated.
	Section 4.3.2, "Recalibrating Sensor Inputs"	Added more detail with subheadings for each type of recalibration.
	Section 5.6, "Configuration Registers"	Added bit 5 BLK_PWR_CTRL to the Configuration 2 Register 44h. The TIMEOUT bit is set to '1' by default for functional revision B and is set to '0' by default for functional revision C.
	Section 5.42, "Revision Register"	Updated revision ID in register FFh from 81h to 82h.
Rev. 1.1 (11-17-10)	Document	Updated for functional revision B. See Section A.7, "Delta from Rev A (Mask A0) to Rev B (Mask B0)".

Table 7.1 Customer Revision History (continued)

REVISION LEVEL & DATE	SECTION/FIGURE/ENTRY	CORRECTION
	Cover	Added to General Description: "includes circuitry and support for enhanced sensor proximity detection." Added the following Features: <ul style="list-style-type: none"> ■ Calibrates for Parasitic Capacitance ■ Analog Filtering for System Noise Sources ■ Press and Hold feature for Volume-like Applications
	Table 2.2, "Electrical Specifications"	Conditions for Power Supply Rejection modified adding the following: Sampling time = 2.56ms Averaging = 1 Negative Delta Counts = Disabled All other parameters default
	Section 5.11, "Calibration Activate Register"	Updated register description to indicate which re-calibration routine is used.
	Section 5.14, "Multiple Touch Configuration Register"	Updated register description to indicate what will happen.
	Table 5.34, "CSx_BN_TH Bit Decode"	Table heading changed from "Threshold Divide Setting" to "Percent Threshold Setting".
Rev. 1.0 (06-14-10)	Initial release	

X-ON Electronics

Largest Supplier of Electrical and Electronic Components

Click to view similar products for [Capacitive Touch Sensors](#) category:

Click to view products by [Microchip](#) manufacturer:

Other Similar products are found below :

[FK 8-1](#) [SMBTASK3KIT6](#) [LC717A30UR-NH](#) [CR12CN04DPO-E2](#) [CR30SCF10ATO](#) [CR30SCF10DPO](#) [BCS M30BBI2-PSC15D-S04K](#)
[FDC1004DGSR](#) [FDC1004DGST](#) [CR18SCF05DPO](#) [CDWM3020ZPM](#) [MTCH6301-I/ML](#) [AT42QT1011-TSHR](#) [BCS M12B4G2-PSC40D-S04K](#) [BCS M12B4I1-PSC40D-EP02](#) [CFAK 12P1103](#) [CFAK 12P1140/L](#) [CFAK 18P1100](#) [CFAK 18P1200](#) [CFAK 30P1100](#) [CFAM 12P1600](#)
[CFAM 18P1600](#) [CFAM 18P1600/S14](#) [CFAM 30P1600](#) [CQ28-10NPP-KW1](#) [CR12CN04DNC](#) [KN056050](#) [KN086050](#) [KN186050](#) [KV750450](#)
[KV750455](#) [17-9291-226](#) [98-0003-3048-4](#) [CR12CN04DNO-E2](#) [PROXISWITCH](#) [CR12CN04DPO](#) [BCS M12BBG1-PSC80H-EP02](#) [BCS](#)
[M30B4I1-PSC15D-EP02](#) [BCS M18B4G2-PSC15H-S04K](#) [CR18CF05DPO-E2](#) [CM30-25NPP-EW1](#) [CM30-25NNP-EW1](#) [CM30-16BPP-EW1](#)
[CM30-16BNP-EW1](#) [CM18-12NPP-EW1](#) [CM18-12NPP-EC1](#) [CM18-12NNP-EW1](#) [CM18-12NNP-EC1](#) [CM18-08BPP-EW1](#) [CM18-08BNP-EW1](#)