



# Water Tolerant Touch Surface Development Kit

---

---

## Water Tolerant Touch Surface Development Kit User's Guide

---

---

### Preface

---



**Important: Notice to customers:**

All documentation becomes dated, and this manual is no exception. Microchip tools and documentation are constantly evolving to meet customer needs, so some actual dialogs and/or tool descriptions may differ from those in this document. Please refer to our website ([www.microchip.com](http://www.microchip.com)) to obtain the latest documentation available.

Documents are identified with a “DS” number. This number is located on the bottom of each page, in front of the page number. The numbering convention for the DS number is “DSXXXXA”, where “XXXX” is the document number and “A” is the revision level of the document.

For the most up-to-date information on development tools, see the MPLAB® IDE online help. Select the Help menu, and then Topics to open a list of available online help files.

---

### Introduction

The Water Tolerant Touch Surface Development Kit showcases Microchip’s robust 2D Touch Surface solution. The kit shows the water tolerance performance of capacitive touch using the PTC’s Driven Shield+ feature. The kit has two self-capacitance touch buttons, 5x6 2D Touch Surface Sensor and driven shield. It also has 14 LEDs to indicate touch position and board information.

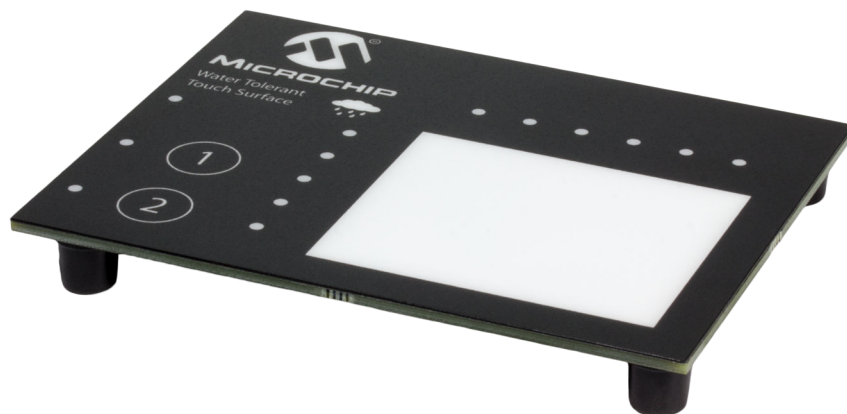

## Table of Contents

---

Preface.....	1
1. Introduction.....	3
1.1. Features and Overview.....	3
1.2. Functional Block Diagram.....	3
2. Getting Started.....	4
2.1. Quick Start.....	4
2.2. Surface Sensor Design.....	6
2.3. Touch Buttons.....	7
2.4. LEDs.....	7
2.5. Documentation and Relevant Links.....	7
3. User's Guide.....	8
3.1. Powering the Board.....	8
3.2. Modes of Operation.....	8
3.3. Application Flow.....	11
4. Hardware Revision History and Known Issues.....	12
4.1. Identifying Product ID and Revision.....	12
4.2. Revision 5.....	12
5. Document Revision History.....	13
The Microchip Web Site.....	14
Customer Change Notification Service.....	14
Customer Support.....	14
Microchip Devices Code Protection Feature.....	14
Legal Notice.....	15
Trademarks.....	15
Quality Management System Certified by DNV.....	16
Worldwide Sales and Service.....	17

## 1. Introduction

### 1.1 Features and Overview

- Surface Sensor: 5x6 Surface Diamond Pattern with Dedicated Driven Shield
- Two Self-Capacitance Touch Buttons
- Microcontroller: ATtiny1617 8-bit AVR Microcontroller - 20 MHz, 16 Kbytes Flash, 2 Kbytes RAM, 128 bytes of EEPROM
- Debugging and Programming: mEBDG with CDC UART
- LEDs: LEDs to Indicate Position and Mode
- LED Driver: MCP23017

### 1.2 Functional Block Diagram

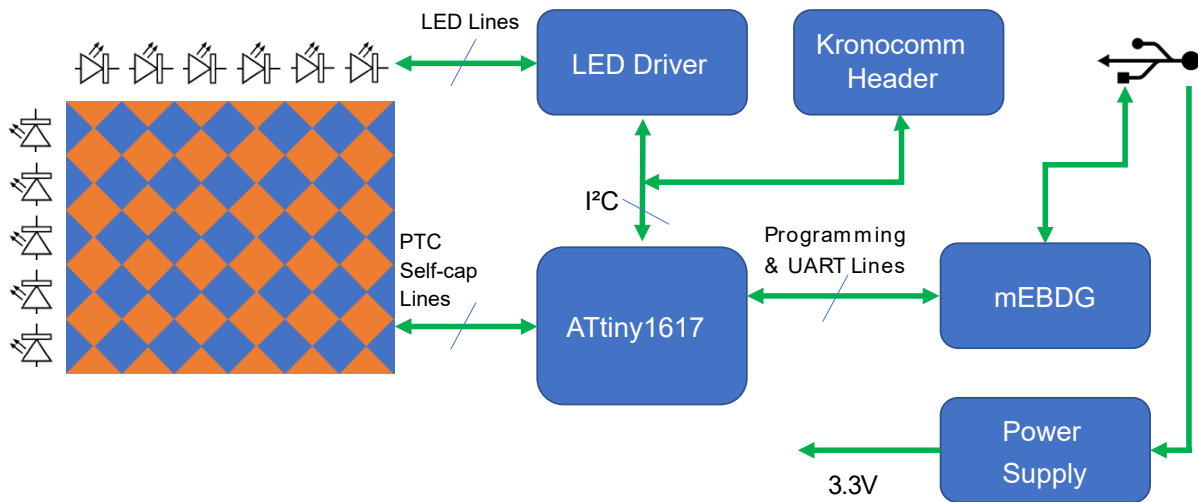

## 2. Getting Started

### 2.1 Quick Start

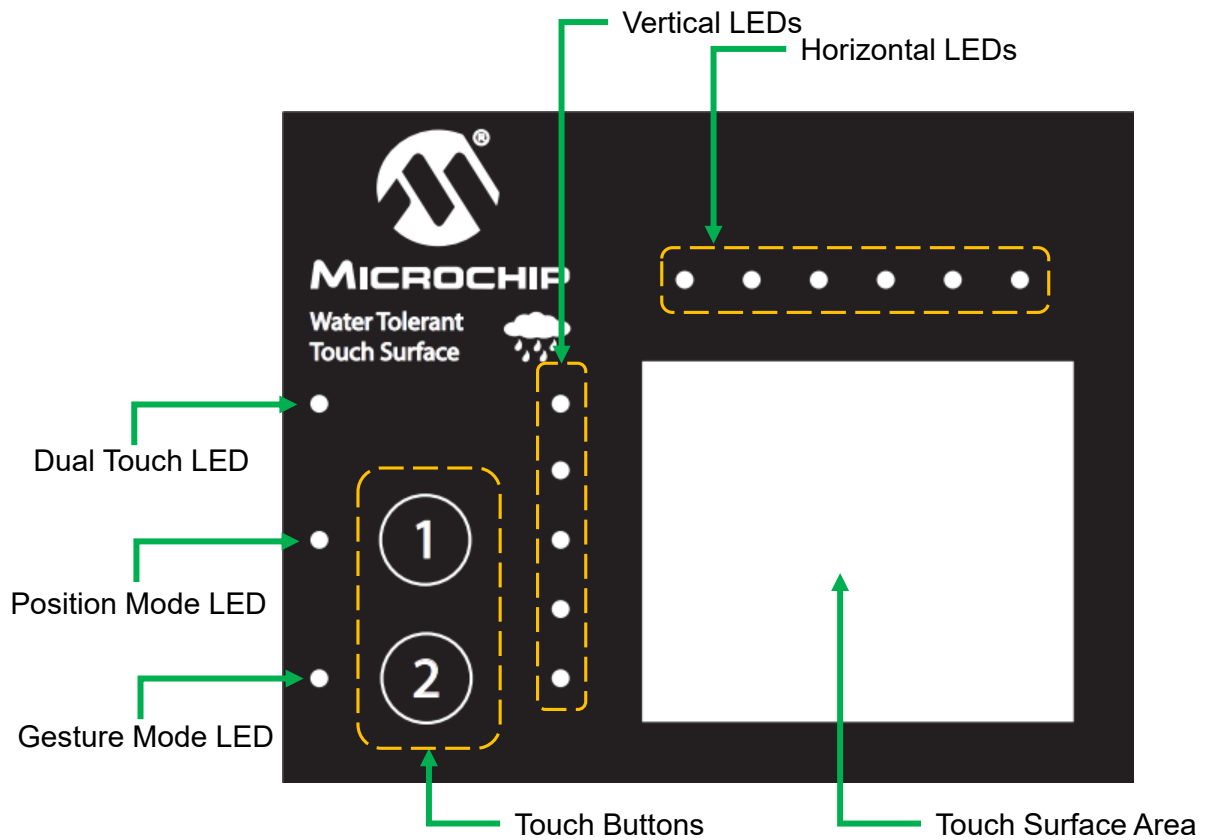

# Water Tolerant Touch Surface Develo...

## Getting Started

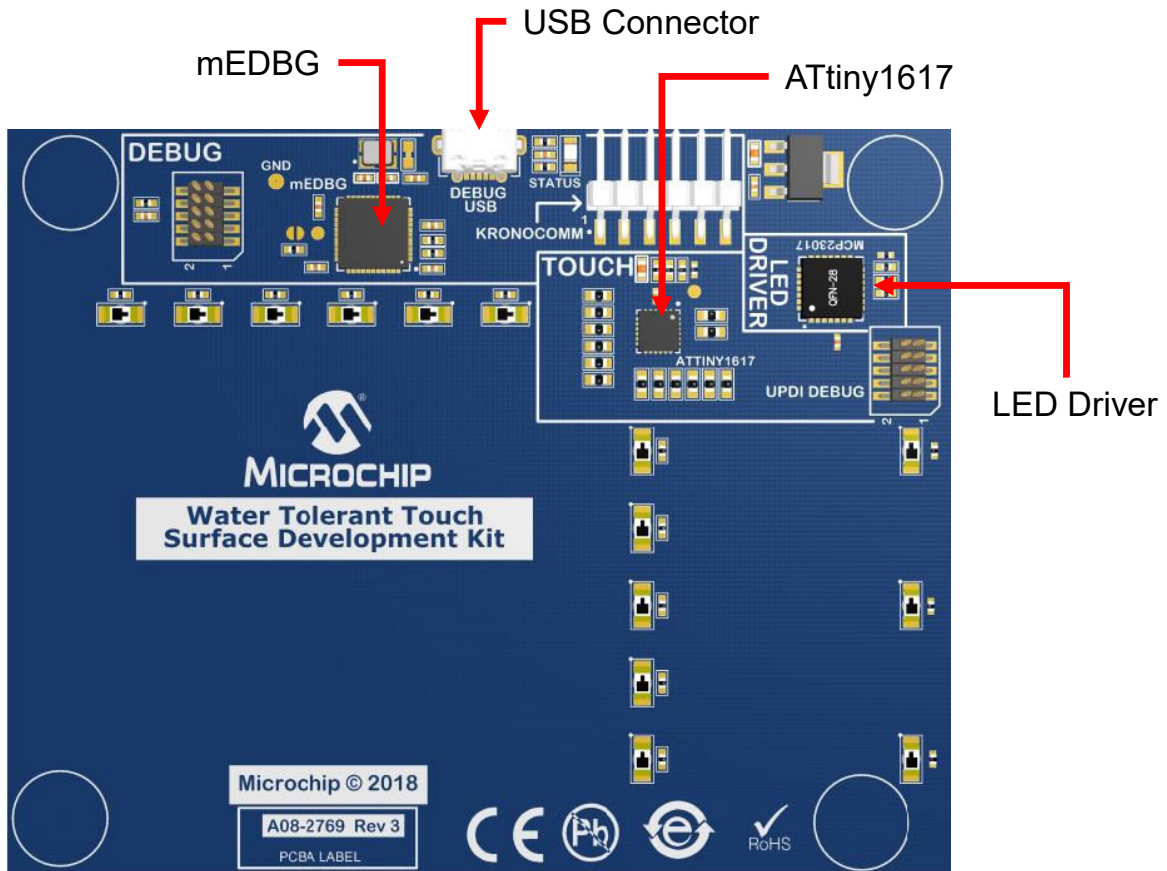

## 2.2 Surface Sensor Design

Figure 2-1. Surface Sensor

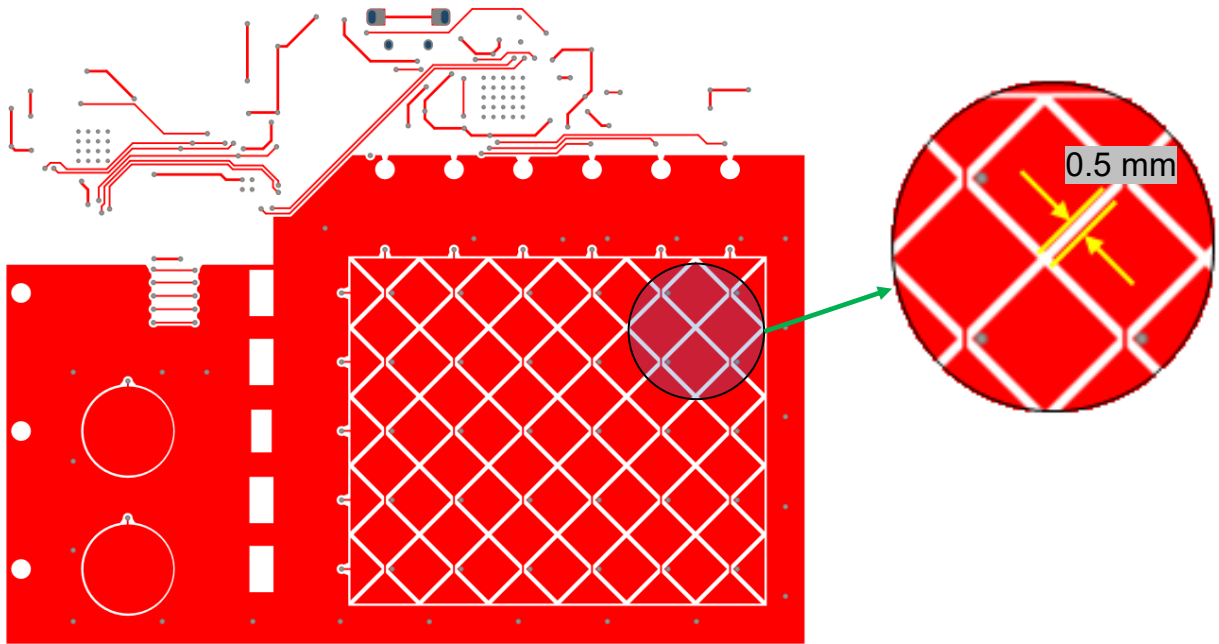
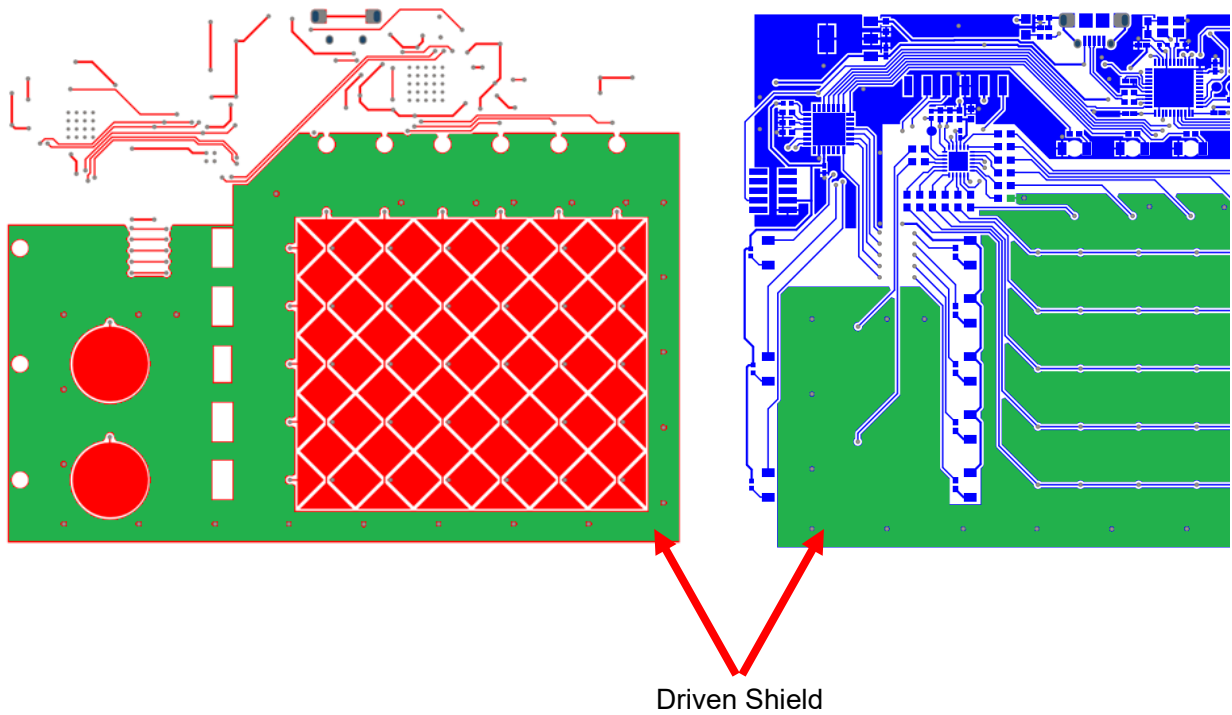

Figure 2-2. Driven Shield



## 2.3 Touch Buttons

### Button 1:

When touched, the kit's mode is changed to Finger Position mode.

### Button 2:

When touched, the kit's mode is changed to Gesture Recognition mode.

## 2.4 LEDs

### Dual touch LED

This LED glows when two fingers touch the touch surface area.

### Position mode LED

This LED glows to indicate that the kit is currently in Position mode.

### Gesture mode LED

This LED glows to indicate that the kit is currently in Gesture mode.

## 2.5 Documentation and Relevant Links

- **Xplained Products:** Xplained evaluation kits are a series of easy-to-use evaluation kits for Microchip microcontrollers and other Microchip products.
  - Xplained Nano – used for low pin count devices and provides a minimalistic solution with access to all I/O pins of the target microcontroller.
  - Xplained Mini – used for medium pin count devices and adds an Arduino Uno compatible header footprint and a prototyping area.
  - Xplained Pro – used for medium to high pin count devices that feature advanced debugging and standardized extensions for peripheral functions.

**Note:** All the above kits have on-board programmers/debuggers, which create a set of low-cost boards for evaluation and demonstration of features and capabilities of different Microchip products.

- **Atmel Start:** This tool will help you select and configure software components and tailor your embedded application in a usable and optimized manner.
- **Atmel Studio:** Free Atmel IDE for development of C/C++ and assembler code for Microchip microcontrollers.
- **Data Visualizer:** Data Visualizer is a program used for processing and visualizing data. Data Visualizer can receive data from various sources such as the Embedded Debugger Data Gateway Interface found on Xplained Pro boards and COM ports.
- **Design Documentation:** Package containing CAD source, schematics, BOM, assembly drawings, 3D plots, layer plots, etc.
- **Hardware User's Guide:** PDF version of this user's guide.
- **Water Tolerant Touch Surface Kit on Microchip Page:** Microchip website link.

### 3. User's Guide

#### 3.1 Powering the Board

The kit takes power from the micro-USB cable. The kit can be powered by connecting the micro-USB cable to the USB connector on the board and to the computer.

#### 3.2 Modes of Operation

The kit operates in two different modes.

##### 3.2.1 Position Mode

In this mode, the user touch position is decoded. Based on the position, the vertical and horizontal LEDs glow. After power-up, the kit works in this mode.

**Note:** In this kit, two-touch is supported only for gestures. No two-individual position can be decoded correctly due to self-capacitance sensor arrangement. If user tries to do two-touch, then the decoding stops and the two-touch LED glows.

##### 3.2.2 Gesture Mode

In Gesture mode, depending on the gesture, the LEDs glow to indicate the gesture. The tap is indicated by a blink and swipes are indicated by LED chasing. The following table provides information on how LEDs glow when a gesture is performed.

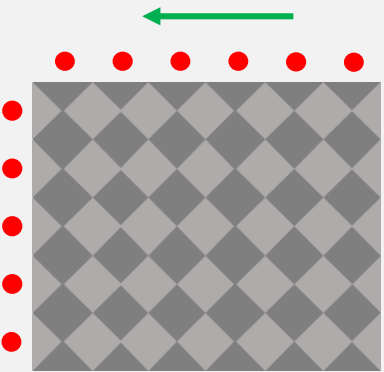
Gesture	LED Chasing Direction
Tap	No chasing. All vertical and horizontal LEDs blink ONCE.
Double-Tap	No chasing. All vertical and horizontal LEDs blink TWICE.
Left Swipe	

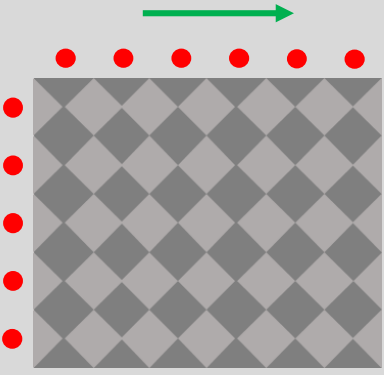
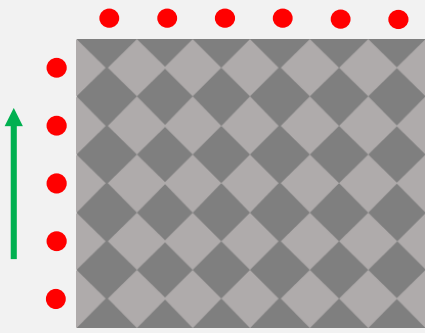
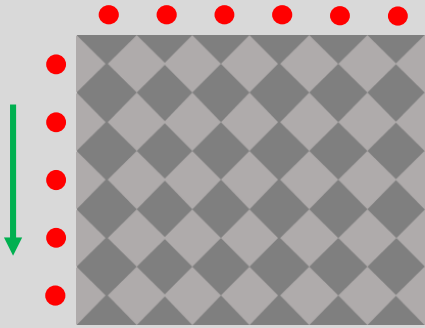
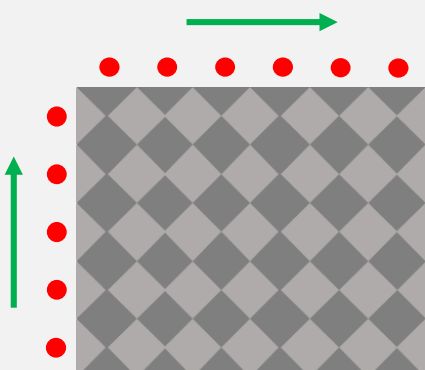

Gesture	LED Chasing Direction
Right Swipe	
Up Swipe	
Down Swipe	
Clockwise Wheel Gesture	

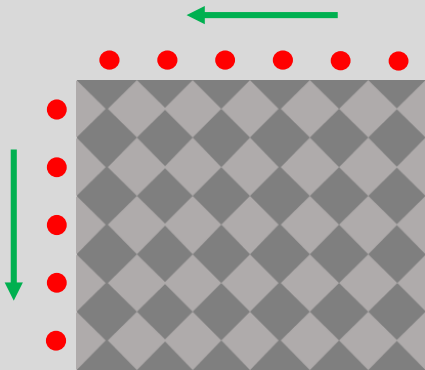
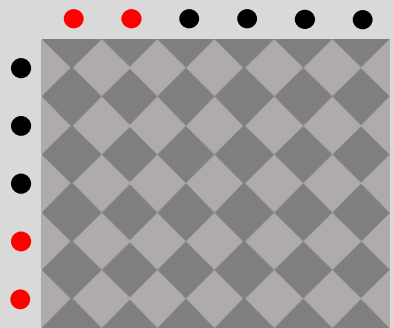
Gesture	LED Chasing Direction
Counterclockwise Wheel Gesture	
Pinch-Zoom	<p>Zoom: The horizontal and vertical LEDs start to glow from one end.</p> <p>Pinch: The horizontal and vertical LEDs start to diminish from one end.</p> 

### 3.2.3 Connecting to GUI

Due to code memory limitation, the application can either use the LEDs to show touch performance or use datastreamer to stream data to the 2D Touch Surface Utility. By default, the project is compiled to display data in LEDs (datastreamer disabled). To connect to GUI, modify the following code in the `touch.h` file and program the `.hex` file.

#### Disable LED:

```
#define ENABLE_LED 0u
```

#### Enable Datastreamer:

```
#define KRONOCOMM_UART 1u
#define KRONOCOMM_ENABLE 1u
#define KRONO_GESTURE_ENABLE 1u
```

Refer to the guide to connect the kit to the datastreamer.

**Comport Settings:** Baud rate is 38400, parity none, Stop bit 1 and flow control none.

### 3.3 Application Flow

The following diagram shows the application flow. Touch measurement is performed at regular intervals. At the end of each measurement, the surface and gesture data are taken from the library. Depending on the position or gesture information, the LEDs are updated.

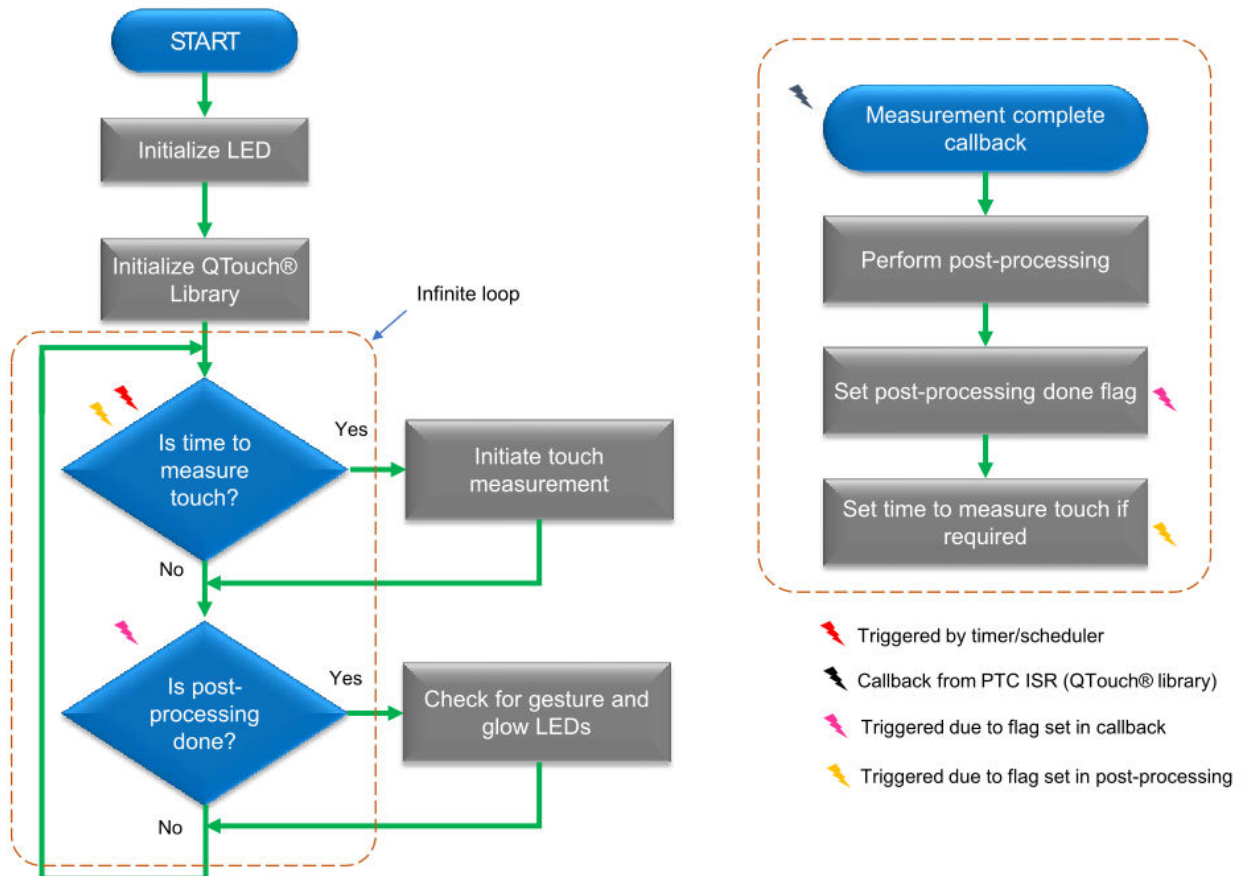

## 4. Hardware Revision History and Known Issues

### 4.1 Identifying Product ID and Revision

The revision and product identifier of the Xplained Pro boards can be found in two ways: either through Atmel Studio or by looking at the sticker on the bottom side of the PCB.

When an Xplained Pro MCU board is connected to a computer with Atmel Studio running, an information window with the serial number is shown. The first six digits of the serial number contain the product identifier and revision. Information about connected Xplained Pro extension boards is also shown in the window.

The same information can be found on the sticker on the bottom side of the PCB. Most kits have stickers that have the identifier and revision printed in plain text as A09-nnnn/rr, where “nnnn” is the identifier and “rr” is the revision. Boards with limited space have a sticker with only a data matrix code, which contains a serial number string.

The serial number string has the following format:

```
"nnnnrrssssssss"
```

n = product identifier

r = revision

s = serial number

The product identifier for the Water Tolerant Touch Surface Kit is A09-3026.

### 4.2 Revision 5

Revision 5 of Water Tolerant Touch Surface Development Kit (A09-3026/05) is the initial released version. There are no known issues.

**5. Document Revision History**

Doc.Rev.	Date	Comments
A	06/2018	Initial document release.

# Water Tolerant Touch Surface Development Kit

---

---

## The Microchip Web Site

---

Microchip provides online support via our web site at <http://www.microchip.com/>. This web site is used as a means to make files and information easily available to customers. Accessible by using your favorite Internet browser, the web site contains the following information:

- **Product Support** – Data sheets and errata, application notes and sample programs, design resources, user's guides and hardware support documents, latest software releases and archived software
- **General Technical Support** – Frequently Asked Questions (FAQ), technical support requests, online discussion groups, Microchip consultant program member listing
- **Business of Microchip** – Product selector and ordering guides, latest Microchip press releases, listing of seminars and events, listings of Microchip sales offices, distributors and factory representatives

## Customer Change Notification Service

---

Microchip's customer notification service helps keep customers current on Microchip products. Subscribers will receive e-mail notification whenever there are changes, updates, revisions or errata related to a specified product family or development tool of interest.

To register, access the Microchip web site at <http://www.microchip.com/>. Under "Support", click on "Customer Change Notification" and follow the registration instructions.

## Customer Support

---

Users of Microchip products can receive assistance through several channels:

- Distributor or Representative
- Local Sales Office
- Field Application Engineer (FAE)
- Technical Support

Customers should contact their distributor, representative or Field Application Engineer (FAE) for support. Local sales offices are also available to help customers. A listing of sales offices and locations is included in the back of this document.

Technical support is available through the web site at: <http://www.microchip.com/support>

## Microchip Devices Code Protection Feature

---

Note the following details of the code protection feature on Microchip devices:

- Microchip products meet the specification contained in their particular Microchip Data Sheet.
- Microchip believes that its family of products is one of the most secure families of its kind on the market today, when used in the intended manner and under normal conditions.
- There are dishonest and possibly illegal methods used to breach the code protection feature. All of these methods, to our knowledge, require using the Microchip products in a manner outside the operating specifications contained in Microchip's Data Sheets. Most likely, the person doing so is engaged in theft of intellectual property.
- Microchip is willing to work with the customer who is concerned about the integrity of their code.

# Water Tolerant Touch Surface Development Kit

---

- Neither Microchip nor any other semiconductor manufacturer can guarantee the security of their code. Code protection does not mean that we are guaranteeing the product as “unbreakable.”

Code protection is constantly evolving. We at Microchip are committed to continuously improving the code protection features of our products. Attempts to break Microchip’s code protection feature may be a violation of the Digital Millennium Copyright Act. If such acts allow unauthorized access to your software or other copyrighted work, you may have a right to sue for relief under that Act.

## Legal Notice

---

Information contained in this publication regarding device applications and the like is provided only for your convenience and may be superseded by updates. It is your responsibility to ensure that your application meets with your specifications. MICROCHIP MAKES NO REPRESENTATIONS OR WARRANTIES OF ANY KIND WHETHER EXPRESS OR IMPLIED, WRITTEN OR ORAL, STATUTORY OR OTHERWISE, RELATED TO THE INFORMATION, INCLUDING BUT NOT LIMITED TO ITS CONDITION, QUALITY, PERFORMANCE, MERCHANTABILITY OR FITNESS FOR PURPOSE. Microchip disclaims all liability arising from this information and its use. Use of Microchip devices in life support and/or safety applications is entirely at the buyer’s risk, and the buyer agrees to defend, indemnify and hold harmless Microchip from any and all damages, claims, suits, or expenses resulting from such use. No licenses are conveyed, implicitly or otherwise, under any Microchip intellectual property rights unless otherwise stated.

## Trademarks

---

The Microchip name and logo, the Microchip logo, AnyRate, AVR, AVR logo, AVR Freaks, BeaconThings, BitCloud, CryptoMemory, CryptoRF, dsPIC, FlashFlex, flexPWR, Heldo, JukeBlox, KeeLoq, KeeLoq logo, Kleer, LANCheck, LINK MD, maXStylus, maXTouch, MediaLB, megaAVR, MOST, MOST logo, MPLAB, OptoLyzer, PIC, picoPower, PICSTART, PIC32 logo, Prochip Designer, QTouch, RightTouch, SAM-BA, SpyNIC, SST, SST Logo, SuperFlash, tinyAVR, UNI/O, and XMEGA are registered trademarks of Microchip Technology Incorporated in the U.S.A. and other countries.

ClockWorks, The Embedded Control Solutions Company, EtherSynch, Hyper Speed Control, HyperLight Load, IntelliMOS, mTouch, Precision Edge, and Quiet-Wire are registered trademarks of Microchip Technology Incorporated in the U.S.A.

Adjacent Key Suppression, AKS, Analog-for-the-Digital Age, Any Capacitor, AnyIn, AnyOut, BodyCom, chipKIT, chipKIT logo, CodeGuard, CryptoAuthentication, CryptoCompanion, CryptoController, dsPICDEM, dsPICDEM.net, Dynamic Average Matching, DAM, ECAN, EtherGREEN, In-Circuit Serial Programming, ICSP, Inter-Chip Connectivity, JitterBlocker, KleerNet, KleerNet logo, Mindi, MiWi, motorBench, MPASM, MPF, MPLAB Certified logo, MPLIB, MPLINK, MultiTRAK, NetDetach, Omniscient Code Generation, PICDEM, PICDEM.net, PICKit, PICtail, PureSilicon, QMatrix, RightTouch logo, REAL ICE, Ripple Blocker, SAM-ICE, Serial Quad I/O, SMART-I.S., SQI, SuperSwitcher, SuperSwitcher II, Total Endurance, TSHARC, USBCheck, VariSense, ViewSpan, WiperLock, Wireless DNA, and ZENA are trademarks of Microchip Technology Incorporated in the U.S.A. and other countries.

SQTP is a service mark of Microchip Technology Incorporated in the U.S.A.

Silicon Storage Technology is a registered trademark of Microchip Technology Inc. in other countries.

GestIC is a registered trademark of Microchip Technology Germany II GmbH & Co. KG, a subsidiary of Microchip Technology Inc., in other countries.

All other trademarks mentioned herein are property of their respective companies.

# Water Tolerant Touch Surface Development Kit

---

---

© 2018, Microchip Technology Incorporated, Printed in the U.S.A., All Rights Reserved.

ISBN: 978-1-5224-3157-2

## Quality Management System Certified by DNV

---

### ISO/TS 16949

Microchip received ISO/TS-16949:2009 certification for its worldwide headquarters, design and wafer fabrication facilities in Chandler and Tempe, Arizona; Gresham, Oregon and design centers in California and India. The Company's quality system processes and procedures are for its PIC<sup>®</sup> MCUs and dsPIC<sup>®</sup> DSCs, KEELOQ<sup>®</sup> code hopping devices, Serial EEPROMs, microperipherals, nonvolatile memory and analog products. In addition, Microchip's quality system for the design and manufacture of development systems is ISO 9001:2000 certified.



## Worldwide Sales and Service

AMERICAS	ASIA/PACIFIC	ASIA/PACIFIC	EUROPE
<p><b>Corporate Office</b> 2355 West Chandler Blvd. Chandler, AZ 85224-6199 Tel: 480-792-7200 Fax: 480-792-7277 Technical Support: <a href="http://www.microchip.com/support">http://www.microchip.com/support</a> Web Address: <a href="http://www.microchip.com">www.microchip.com</a></p> <p><b>Atlanta</b> Duluth, GA Tel: 678-957-9614 Fax: 678-957-1455</p> <p><b>Austin, TX</b> Tel: 512-257-3370</p> <p><b>Boston</b> Westborough, MA Tel: 774-760-0087 Fax: 774-760-0088</p> <p><b>Chicago</b> Itasca, IL Tel: 630-285-0071 Fax: 630-285-0075</p> <p><b>Dallas</b> Addison, TX Tel: 972-818-7423 Fax: 972-818-2924</p> <p><b>Detroit</b> Novi, MI Tel: 248-848-4000</p> <p><b>Houston, TX</b> Tel: 281-894-5983</p> <p><b>Indianapolis</b> Noblesville, IN Tel: 317-773-8323 Fax: 317-773-5453 Tel: 317-536-2380</p> <p><b>Los Angeles</b> Mission Viejo, CA Tel: 949-462-9523 Fax: 949-462-9608 Tel: 951-273-7800</p> <p><b>Raleigh, NC</b> Tel: 919-844-7510</p> <p><b>New York, NY</b> Tel: 631-435-6000</p> <p><b>San Jose, CA</b> Tel: 408-735-9110 Tel: 408-436-4270</p> <p><b>Canada - Toronto</b> Tel: 905-695-1980 Fax: 905-695-2078</p>	<p><b>Australia - Sydney</b> Tel: 61-2-9868-6733</p> <p><b>China - Beijing</b> Tel: 86-10-8569-7000</p> <p><b>China - Chengdu</b> Tel: 86-28-8665-5511</p> <p><b>China - Chongqing</b> Tel: 86-23-8980-9588</p> <p><b>China - Dongguan</b> Tel: 86-769-8702-9880</p> <p><b>China - Guangzhou</b> Tel: 86-20-8755-8029</p> <p><b>China - Hangzhou</b> Tel: 86-571-8792-8115</p> <p><b>China - Hong Kong SAR</b> Tel: 852-2943-5100</p> <p><b>China - Nanjing</b> Tel: 86-25-8473-2460</p> <p><b>China - Qingdao</b> Tel: 86-532-8502-7355</p> <p><b>China - Shanghai</b> Tel: 86-21-3326-8000</p> <p><b>China - Shenyang</b> Tel: 86-24-2334-2829</p> <p><b>China - Shenzhen</b> Tel: 86-755-8864-2200</p> <p><b>China - Suzhou</b> Tel: 86-186-6233-1526</p> <p><b>China - Wuhan</b> Tel: 86-27-5980-5300</p> <p><b>China - Xian</b> Tel: 86-29-8833-7252</p> <p><b>China - Xiamen</b> Tel: 86-592-2388138</p> <p><b>China - Zhuhai</b> Tel: 86-756-3210040</p>	<p><b>India - Bangalore</b> Tel: 91-80-3090-4444</p> <p><b>India - New Delhi</b> Tel: 91-11-4160-8631</p> <p><b>India - Pune</b> Tel: 91-20-4121-0141</p> <p><b>Japan - Osaka</b> Tel: 81-6-6152-7160</p> <p><b>Japan - Tokyo</b> Tel: 81-3-6880-3770</p> <p><b>Korea - Daegu</b> Tel: 82-53-744-4301</p> <p><b>Korea - Seoul</b> Tel: 82-2-554-7200</p> <p><b>Malaysia - Kuala Lumpur</b> Tel: 60-3-7651-7906</p> <p><b>Malaysia - Penang</b> Tel: 60-4-227-8870</p> <p><b>Philippines - Manila</b> Tel: 63-2-634-9065</p> <p><b>Singapore</b> Tel: 65-6334-8870</p> <p><b>Taiwan - Hsin Chu</b> Tel: 886-3-577-8366</p> <p><b>Taiwan - Kaohsiung</b> Tel: 886-7-213-7830</p> <p><b>Taiwan - Taipei</b> Tel: 886-2-2508-8600</p> <p><b>Thailand - Bangkok</b> Tel: 66-2-694-1351</p> <p><b>Vietnam - Ho Chi Minh</b> Tel: 84-28-5448-2100</p>	<p><b>Austria - Wels</b> Tel: 43-7242-2244-39 Fax: 43-7242-2244-393</p> <p><b>Denmark - Copenhagen</b> Tel: 45-4450-2828 Fax: 45-4485-2829</p> <p><b>Finland - Espoo</b> Tel: 358-9-4520-820</p> <p><b>France - Paris</b> Tel: 33-1-69-53-63-20 Fax: 33-1-69-30-90-79</p> <p><b>Germany - Garching</b> Tel: 49-8931-9700</p> <p><b>Germany - Haan</b> Tel: 49-2129-3766400</p> <p><b>Germany - Heilbronn</b> Tel: 49-7131-67-3636</p> <p><b>Germany - Karlsruhe</b> Tel: 49-721-625370</p> <p><b>Germany - Munich</b> Tel: 49-89-627-144-0 Fax: 49-89-627-144-44</p> <p><b>Germany - Rosenheim</b> Tel: 49-8031-354-560</p> <p><b>Israel - Ra'anana</b> Tel: 972-9-744-7705</p> <p><b>Italy - Milan</b> Tel: 39-0331-742611 Fax: 39-0331-466781</p> <p><b>Italy - Padova</b> Tel: 39-049-7625286</p> <p><b>Netherlands - Drunen</b> Tel: 31-416-690399 Fax: 31-416-690340</p> <p><b>Norway - Trondheim</b> Tel: 47-7289-7561</p> <p><b>Poland - Warsaw</b> Tel: 48-22-3325737</p> <p><b>Romania - Bucharest</b> Tel: 40-21-407-87-50</p> <p><b>Spain - Madrid</b> Tel: 34-91-708-08-90 Fax: 34-91-708-08-91</p> <p><b>Sweden - Gothenberg</b> Tel: 46-31-704-60-40</p> <p><b>Sweden - Stockholm</b> Tel: 46-8-5090-4654</p> <p><b>UK - Wokingham</b> Tel: 44-118-921-5800 Fax: 44-118-921-5820</p>

## X-ON Electronics

Largest Supplier of Electrical and Electronic Components

*Click to view similar products for [Touch Sensor Development Tools](#) category:*

*Click to view products by [Microchip](#) manufacturer:*

Other Similar products are found below :

[ATMXT1066T2-DEV-PCB](#) [ATMXT336UDEVPCB](#) [ATMXT641TDAT-I2C-PCB](#) [1374](#) [MIKROE-1906](#) [1602](#) [SEN0164](#) [1982](#) [STEVAL-PCC009V3](#) [ATSAMD20-QTRDEMO](#) [ATQT2-XPRO](#) [ATQT6-XPRO](#) [2340](#) [DM160221](#) [DM160229](#) [DM160222](#) [ATQT5-XPRO](#) [DFR0129](#) [SEN0170](#) [SLEXP8019A](#) [SLEXP8018A](#) [1375](#) [DFR0386](#) [SEN0186](#) [SEN0148](#) [DK-000013-03](#) [ROB0103](#) [cs-useful-01](#) [DFR0385](#) [SEN0184](#) [SX8651EVKA](#) [1362](#) [1580](#) [2024](#) [3575](#) [4830](#) [AS8579-TS\\_EK\\_DB](#) [ATQT600](#) [IQS227/228ASEV01](#) [SKU-6515](#) [CY3280-MBR2](#) [CY3280-MBR3](#) [DFR0030](#) [DM160219](#) [AC160219](#) [AC320007](#) [ATEVK-MXT1066T2-A](#) [ATEVK-MXT1189TAT-C](#) [ATEVK-MXT1189TDAT-A](#) [ATEVK-MXT1665TAT-C](#)