

Processor Module and Device Adapter Specification

CONTENTS

1.0 Introduction	1
2.0 MPLAB ICE 2000 System.....	1
3.0 Emulator-Related Issues	2
4.0 Processor Modules	2
5.0 Device Adapter Issues	4
6.0 Device Adapter Target Footprints	10

1.0 INTRODUCTION

The processor modules for MPLAB ICE 2000 are interchangeable personality modules that allow MPLAB ICE 2000 to be reconfigured for emulation of different PICmicro[®] microcontrollers (MCUs). This modularity allows the emulation of many different devices with the addition of a processor module and device adapter, which provides a very cost effective multiprocessor emulation system.

The device adapters for MPLAB ICE 2000 are interchangeable assemblies that allow the emulator system to interface to a target application system. Device adapters also have control logic that allows the target application to provide a clock source and power to the processor module. The device adapters support PICmicro MCUs in DIP, SDIP and PLCC packages.

Transition sockets, used along with a device adapter, provide a method of accommodating all PICmicro MCU packages, including SOIC, SSOP, PQFP and TQFP packages.

2.0 MPLAB ICE 2000 SYSTEM

A brief overview of the different components of the system is shown in the figure below. Each component is discussed in the following subsections.

FIGURE 2-1: MPLAB[®] ICE 2000 EMULATOR SYSTEM

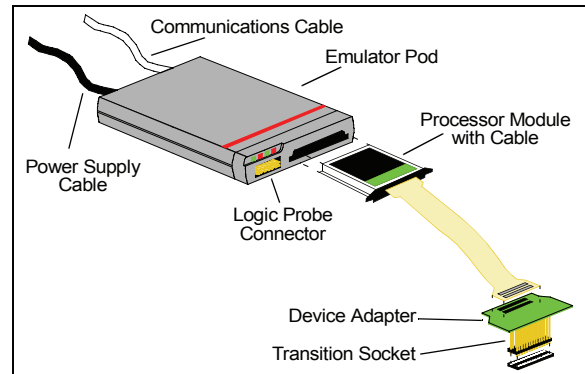

2.1 Host to Pod Cable

This is a standard parallel interface cable. MPLAB ICE 2000 is tested with a 6-foot cable. A longer cable may work, but is not ensured. The cable connects to a parallel port on the PC. If a PC has a printer connected to an LPT device, it is recommended that an additional interface card be installed, rather than using a splitter or an A/B switch.

2.2 Emulator Pod

The Emulator Pod contains emulator memory and control logic. MPLAB ICE 2000 contains a main board and an additional board for expanded trace memory and complex control logic. There are no field serviceable parts in the pod. For more information on the pod, see the MPLAB ICE 2000 on-line help file in MPLAB IDE ([Help>Topics](#)) or the "MPLAB[®] ICE 2000 In-Circuit Emulator User's Guide" (DS51488).

The MPLAB ICE 2000 processor module is inserted into the pod for operation.

2.3 Processor Module

The processor module contains the emulator chip, logic and low-voltage circuitry. There are no field-serviceable parts mounted on the printed circuit board housed within the processor module enclosure.

2.4 Flex Circuit Cable

Once the processor module is inserted into the emulator pod, the flex circuit cable extends the emulator system to the target application. This is a custom cable that is attached inside the processor module enclosure, and can be replaced in the field by removing the end cap of the processor module enclosure.

Please, DO NOT PULL on the flex circuit cable to remove the processor module from the pod. Use the fins of the processor module end cap to leverage the module from the pod.

Emulator analog functions may not operate within the performance specifications published in the device data sheet due to parasitic capacitance (up to 120 pf) of the flex cable.

2.5 Device Adapter

The device adapter provides a common interface for the device being emulated. It is provided in standard DIP and PLCC styles. The adapter also contains a special device that provides an oscillator clock to accurately emulate the oscillator characteristics of the PICmicro MCU.

Due to components on the device adapter, which require target power, the device adapter should be removed from the flex circuit cable (see Figure 2-1) when emulator power is being used and the processor module is not connected to the target. This will eliminate any loading effects on I/O pins.

2.6 Transition Socket

Transition Sockets are available in various styles to allow a common device adapter to be connected to one of the supported surface mount package styles. Transition sockets are available for various pin counts and pitches for SOIC, QFP and other styles. For more information on transition sockets, see the “MPLAB® ICE 2000/4000 Transition Socket Specification” (DS51194).

An emulator system consists of the following components which can be ordered separately:

- An emulator pod (including the host-to-pod cable and power supply)
- A processor module (including the flex circuit cable)
- A device adapter
- An optional transition socket (for surface mount emulation)

3.0 EMULATOR-RELATED ISSUES

General limitations that apply to the MPLAB ICE 2000 emulator may be found in the on-line help. Select [Help>Topics](#) and then select “MPLAB ICE 2000” under “Debuggers”.

Device-specific limitations can be found as above or by selecting [Debugger>Settings](#), clicking the **Limitations** tab, and then clicking the **Details** button.

4.0 PROCESSOR MODULES

Processor modules are identified on the top of the assembly (e.g., PCM18XA0). To determine which processors are supported by a specific module, refer to the file “Readme for MPLAB ICE 2000.txt” in the MPLAB IDE installation directory or the latest “*Product Selector Guide*” (DS00148), which can be found on the Microchip web site at www.microchip.com.

A typical processor module contains a special bond-out version of a PICmicro MCU, with device buffers to control data flow and control logic. It provides the means of configuring the MPLAB ICE 2000 emulator for a specific PICmicro MCU family and handles low-voltage emulation when needed.

Note: When removing the processor module, DO NOT PULL on the flex cable. Use the tabs on the processor module or damage to the flex cable may occur.

4.1 Power

The operating voltage for most of the control logic and buffering on the processor module is +5V and is supplied by the emulator pod. Power to the emulator processor and some of its surrounding buffers is user-selectable, and can be powered by the emulator pod (at +5V only) or the target application system (from 2.0V to 5.5V). This is software selectable and is configurable through the MPLAB® IDE software. At no time will the emulator system directly power the target application system. ALWAYS insert the processor module into the emulator pod before applying power to the pod.

When connecting to a target application system, there may be a voltage level on the target application even though power has not yet been applied to the target application circuit. This is normal, and is due to current leakage through VCC of the device adapter. The current leakage will typically be less than 20 mA. However, if the target application is using a voltage regulator, it should be noted that some regulators require the use of an external shunt diode between VIN and VOUT for reverse-bias protection. Refer to the manufacturer’s data sheets for additional information.

Processor Module and Device Adapter Specification

4.1.1 EMULATOR PROCESSOR POWER SUPPLIED BY EMULATOR SYSTEM

If the emulator system is selected to power the emulator processor in the processor module, the emulator system can be operated without being connected to a target application. If the system is being connected to a target application, the power to the pod should be applied before applying power to the target application.

The target application system's VCC will experience a small current load (10 mA typical) when the emulator system is connected via a device adapter. This is because the target system must always power the clock chip in the processor module.

4.1.2 EMULATOR PROCESSOR POWER SUPPLIED BY TARGET APPLICATION SYSTEM

When the MPLAB IDE software is brought up, the emulator system is first initialized with the emulator system powering the emulator processor. The "Processor Power Supplied by Target Board" option may then be selected using the **Power** tab of the Settings dialog (*Debugger>Settings*) to power the processor module from the target board.

When operating from external power, the processor module will typically represent a current load equivalent to the device being emulated (according to its data sheet) plus approximately 100 mA. Keep in mind that the target application will affect the overall current load of the processor module, dependent upon the load placed upon the processor I/O.

When the processor power is supplied by the target application system, an external clock (from the target board) may also be provided. MPLAB IDE will not allow use of an external clock without the use of external power.

4.1.3 OPERATING VOLTAGE OF 4.6 TO 5.5 VOLTS

If the target application system's operating voltage is between 4.55V (± 120 mV) and 5.5V, the processor module will consider this a STANDARD VOLTAGE condition. In this mode, the processor can run to its highest rated speed (as indicated in its data sheet).

The recommended power-up sequence is:

1. Apply power to the PC host.
2. Apply power to the emulator pod and processor module assembly.
3. Invoke MPLAB IDE.
4. Select *Debugger > Settings* and click the **Power** tab. Configure system for "Processor Power Supplied by Target Board".
5. At the error message, apply power to the target application circuit. Then acknowledge the error.
6. Issue a System Reset (from the debugger menu) before proceeding.

4.1.4 OPERATING VOLTAGE OF 2.0 TO 4.6 VOLTS

If the target application system's operating voltage is between 2.0V and 4.55V (± 120 mV), the processor module will consider this a LOW VOLTAGE condition. In this mode, the processor is limited to its rated speed at a given voltage level (as indicated in its data sheet).

To minimize the amount of reverse current that the target system is exposed to, the recommended power-up sequence is:

1. Apply power to the PC host.
2. Apply power to the emulator pod and processor module assembly.
3. Invoke MPLAB IDE.
4. Select *Debugger > Settings* and click the **Power** tab. Configure system for "Processor Power Supplied by Target Board".
5. At the error message, apply power to the target application circuit. Then acknowledge the error.
6. Issue a System Reset (from the debugger menu) before proceeding.
7. Select *Debugger > Settings* and click the **Power** tab. Verify that the dialog says "Low Voltage Enabled." Click **Cancel** to close the dialog.

4.2 Operating Frequency

The processor modules will support the maximum frequency (except where noted in **Section 3.0 "Emulator-Related Issues"**) of the device under emulation. The maximum frequency of a PICmicro MCU device is significantly lower when the operating voltage is less than 4.5V.

The processor modules will support a minimum frequency of 32 kHz. When operating at low frequencies, response to the screen may be slow.

4.3 Clock Options

MPLAB ICE 2000 allows internal and external clocking. When set to internal, the clock is supplied from the internal programmable clock, located in the emulator pod. When set to external, the oscillator on the target application system will be utilized.

4.3.1 CLOCK SOURCE FROM EMULATOR

Refer to the MPLAB ICE 2000 on-line help file in MPLAB IDE (*Help>Topics*) or the "MPLAB[®] ICE 2000 In-Circuit Emulator User's Guide" (DS51488), "Using the On-Board Clock", for configuring MPLAB IDE to supply the clock source.

4.3.2 CLOCK SOURCE FROM THE TARGET APPLICATION

If the target application is selected to provide the clock source, the target board must also be selected to power the emulator processor (see the MPLAB ICE 2000 on-line help file in MPLAB IDE (*Help>Topics*) or the “MPLAB® ICE 2000 In-Circuit Emulator User’s Guide” (DS51488), “Using a Target Board Clock”).

At low voltage, the maximum speed of the processor will be limited to the rated speed of the device under emulation.

An oscillator circuit on the device adapter generates a clock to the processor module and buffers the clock circuit on the target board. In this way, the MPLAB ICE 2000 emulator closely matches the oscillator options of the actual device. All oscillator modes are supported (as documented in the device’s data sheet) except as noted in **Section 3.0 “Emulator-Related Issues”**. The OSC1 and OSC2 inputs of the device adapter have a 5 pF to 10 pF load. Be aware of this when using a crystal in HS, XT, LP or LF modes, or an RC network in RC mode.

The frequency of the emulated RC network may vary relative to the actual device due to emulator circuitry. If a specific frequency is important, adjust the RC values to achieve the desired frequency. Another alternative would be to allow the emulator to provide the clock as described in **Section 4.3.1 “Clock Source from Emulator”**.

When using the target board clock, the system’s operating voltage is between 2.5V and 5.5V.

4.4 ESD Protection and Electrical Overstress

All CMOS chips are susceptible to electrostatic discharge (ESD). In the case of the processor modules, the pins of the CMOS emulator are directly connected to the target connector, making the chip vulnerable to ESD. ESD can also induce latch-up in CMOS chips, causing excessive current through the chip and possible damage. MPLAB ICE 2000 has been designed to minimize potential damage by implementing overcurrent protection and transient suppressors. However, care should be given to minimizing ESD conditions while using the system.

During development, contention on an I/O pin is possible (e.g., when an emulator pin is driving a ‘1’ and the target board is driving a ‘0’). Prolonged contention may cause latch-up and damage to the emulator chip. One possible precaution is to use current limiting resistors (~100 Ω) during the development phase on bidirectional I/O pins. Using limiting resistors can also help avoid damage to modules, device adapters and pods that occurs when a voltage source is accidentally connected to an I/O pin on the target board.

4.5 Freeze Mode

The MPLAB ICE 2000 system allows the option of “freezing” peripheral operation or allowing them to continue operating when the processor is halted. This option is configured in the MPLAB IDE. The Freeze function is available on all processor modules except the PCM16XA0.

This function is useful to halt an on-board timer while at a break point. At a break point and while single stepping, interrupts are disabled.

5.0 DEVICE ADAPTER ISSUES

This section details processor-specific considerations that have been made on device adapters. Only adapters with special considerations are listed.

There will be a max of 10 mA of current draw from the target system even when the emulator processor module is being powered by the emulator system, and running internal clock. This is due to components on the device adapter being powered by the target board.

Processor Module and Device Adapter Specification

5.1 DVA12XP080

This device adapter is intended for use with PIC12C50X 8-pin DIP devices. It has four mechanical switches that allow target pins GP2 to GP5 to be routed to the emulator silicon on the PCM16XA0 processor module or the oscillator chip on the device adapter, as shown in Table 5-1.

In addition, a 24C00 EEPROM (U1) is connected to RA0 and RA1 of the emulator silicon to support the EEPROM capabilities of the PIC12CE51X family devices. For information on how to use EEPROM memory, see the MPLAB IDE on-line device-specific limitations for the PCM16XA0 (PIC12CE518/519) devices by selecting *Debugger>Settings*, clicking the **Limitations** tab, and then clicking the **Details** button.

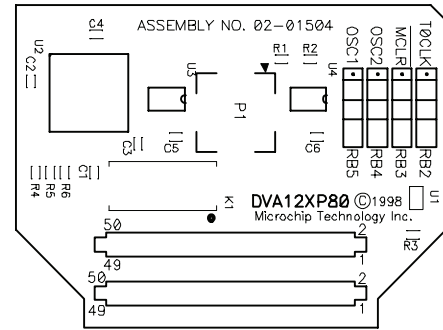

TABLE 5-1: DVA12XP080 DEVICE ADAPTER SWITCH ASSIGNMENT

Desired Function	Switch Positions
RB2	Set S4 to RB2
RB3	Set S3 to RB3
RB4	Set S2 to RB4
RB5	Set S1 to RB5
MCLR	Set S3 to MCLR
External Oscillator Input	Set S1 to OSC1 and set S2 to OSC2
TIMER0 Clock Input	Set S4 to T0CKI

5.2 DVA12XP081

This device adapter is intended for use with PIC12C67X 8-pin DIP devices. It has two mechanical switches that allow target pins GP4 and GP5 to be routed to the emulator silicon on the PCM12XA0 processor module or the oscillator device on the device adapter, as shown in Table 5-2.

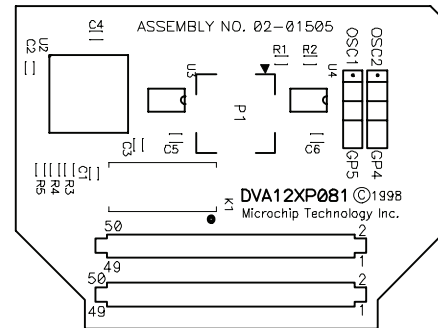

TABLE 5-2: DVA12XP081 DEVICE ADAPTER SWITCH ASSIGNMENT

Desired Function	Switch Positions
GP4	Set S2 to GP4
GP5	Set S1 to GP5
External Oscillator Input	Set S1 to OSC1 and set S2 to OSC2

MPLAB® ICE 2000

5.3 DVA14XP280

This device adapter is intended for use with the PIC14000 28-pin DIP device. It has two mechanical switches that allow target pins OSC1 and OSC2 to be routed to the emulator silicon on the PCM14XA0 processor module or the oscillator device on the device adapter, as shown in Table 5-3.

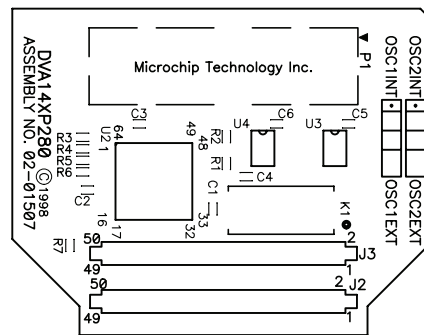

TABLE 5-3: DVA14XP280 DEVICE ADAPTER SWITCH ASSIGNMENT

Desired Function	Switch Position
IN Mode	Set S1 to OSC2INT Set S2 to OSC1INT
HS Mode	Set S1 to OSC2EXT Set S2 to OSC1EXT

5.4 DVA16XP140

This device adapter is intended for use with the PIC16C505 14-pin DIP device. It has four mechanical switches. Two of the switches allow target pins RB4 and RB5 to be routed to the emulator silicon on the PCM16XA0 processor module or the oscillator device on the device adapter. The other two switches control the routing of RB3 and RC5 signals. RB3 can be a general purpose input or $\overline{\text{MCLR}}$. RC5 can be a general purpose I/O or can drive the TOCKI input, as shown in Table 5-4.

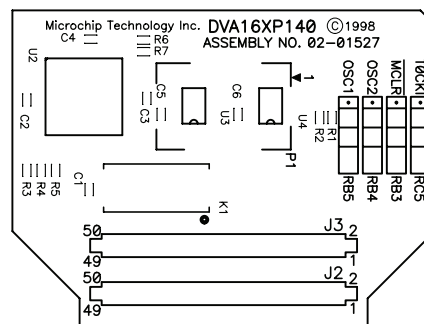

TABLE 5-4: DVA16XP140 DEVICE ADAPTER SWITCH ASSIGNMENT

Desired Function	Switch Positions
RC5	Set S4 to RC5
RB3	Set S3 to RB3
RB4	Set S2 to RB4
RB5	Set S1 to RB5
$\overline{\text{MCLR}}$	Set S3 to $\overline{\text{MCLR}}$
External Oscillator Input	Set S1 to OSC1 and set S2 to OSC2
TIMER0 Clock Input	Set S4 to TOCKI

Processor Module and Device Adapter Specification

5.5 DVA16XP182

This device adapter is intended for use with PIC16C712/716 18-pin DIP devices. It has a second oscillator device that allows TIMER1 oscillator input ranging from 32-40 kHz. It has four mechanical switches. Target pins RB1 and RB2 can be routed to the emulator silicon on the PCM16XE1 processor module or the TIMER1 oscillator device on the device adapter. Target pin RB1 is routed to T1CKI. Target pin RB3 can be a general purpose input or CCP1, as shown in Table 5-5.

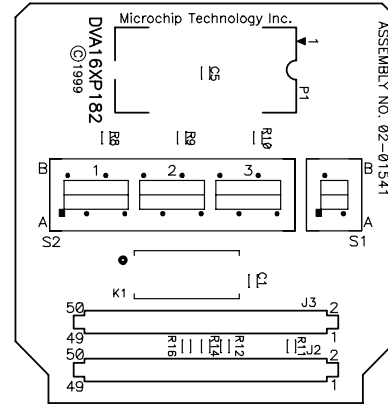

TABLE 5-5: DVA16XP182 DEVICE ADAPTER SWITCH ASSIGNMENT

Desired Function	Switch Positions
RB1	Set S2-1 to position B
RB2	Set S2-2 to position B
RB3	Set S2-3 to position B
CCP1	Set S2-3 to position A
TIMER1 Clock Input	Set S2-1 to position A and set S1 to position B
TIMER1 Oscillator Input	Set S2-1 to position A and set S2-2 to position A and set S1 to position A

MPLAB® ICE 2000

5.6 DVA16XP187

This device adapter is intended for use with PIC16F716 18-pin DIP devices. It has a second oscillator device that allows TIMER1 oscillator input ranging from 32-40 kHz. It has four mechanical switches. Target pins RB1 and RB2 can be routed to the emulator silicon on the PCM16YJ0 processor module or the TIMER1 oscillator device on the device adapter. Target pin RB1 is routed to T1CKI. Target pin RB3 can be a general purpose input or CCP1, as shown in Table 5-5.

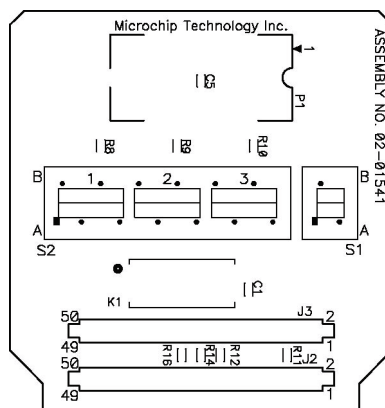

TABLE 5-6: DVA16XP187 DEVICE ADAPTER SWITCH ASSIGNMENT

Desired Function	Switch Positions
RB1	Set S2-1 to position B
RB2	Set S2-2 to position B
RB3	Set S2-3 to position B
CCP1	Set S2-3 to position B
TIMER1 Clock Input	Set S2-1 to position B and set S1 to position B
TIMER1 Oscillator Input	Set S2-1 to position A and set S2-2 to position A and set S1 to position A

5.7 DVA16XP282, DVA16XP401, DVA16XL441 and DVA16PQ441

These device adapters are intended for use with PICmicro MCU devices supported by the PCM16XB0/B1, PCM16XE0/E1, PCM16XK0 and the PCM16XL0 processor modules. The device adapters have a second oscillator device that allows TIMER1 oscillator input ranging from 32 to 40 kHz.

For PCM16XB0/B1, PCM16XE0/E1, PCM16XK0 and PCM16XL0, configure jumper J1 per Table 5-7.

For all other processor modules supported by these device adapters, leave the jumper on pins 1-2 (**OFF**); the Timer1 oscillator enable/disable function is software configurable.

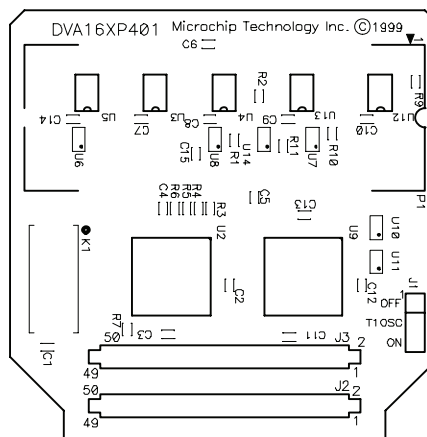

TABLE 5-7: DVA16XP282, DVA16XP401, DVA16XL441 AND DVA16PQ441 JUMPER SETTINGS

Desired Function	Switch Positions	Results
TIMER1 Oscillator Input enabled	Short J1 pins 2-3 (ON)	RC0/T1OSO/T1CKI pin = T1OSO RC1/T1OSI/CCP2 pin = T1OSI
TIMER1 Oscillator Input disabled	Short J1 pins 1-2 (OFF)	RC0/T1OSO/T1CKI pin = RC0 or T1CKI RC1/T1OSI/CCP2 pin = RC1 or CCP2

Processor Module and Device Adapter Specification

5.8 DVA17XXXX0

These device adapters are intended for use with PICmicro MCU devices supported by the PCM17XA0 processor module. In all processors in EC mode, OSC/4 is not supported. OSC/4 in EC mode is supported in DVA17XXXX1 device adapters.

5.9 Emulating a .600 28-Pin Part

When emulating a .600 wide, 28-pin device, an adapter will be needed to convert the standard .300 wide socket on the device adapters to the .600 wide socket on the target board.

There are many adapters available for this purpose, such as Digi-Key part number A502-ND.

5.10 T1OSC Jumper

Some device adapters are equipped with a 3-pin jumper to force the device adapter to enable/disable the Timer1 oscillator circuitry.

When in the “ON” position, the device adapter’s Timer1 oscillator circuitry is always enabled regardless of the T1OSCEN bit in T1CON.

When in the “OFF” position, the device adapter’s Timer1 oscillator circuit is enabled/disabled by software in application code by the T1OSCEN bit in T1CON.

<p>Note: PCM16XB0/B1, PCM16XE0/E1, PCM16XK0 and PCM16XL0 do not support software enable/disable of the Timer1 circuitry and must use the jumper to either enable or disable the function (see Table 5-7 for DVA16XP282, DVA16XP401, DVA16XL441 and DVA16PQ441).</p>
--

6.0 DEVICE ADAPTER TARGET FOOTPRINTS

To connect an emulator device adapter directly to a target board (without the use of transition sockets) the following information will be helpful.

6.1 DIP Device Footprints

DIP device adapter footprints shown will accept adapter plugs like Samtec series APA plugs. These plugs can be soldered in place during development/emulation and eliminate the need for any other sockets.

FIGURE 6-1: DVA DRAWING – DIP

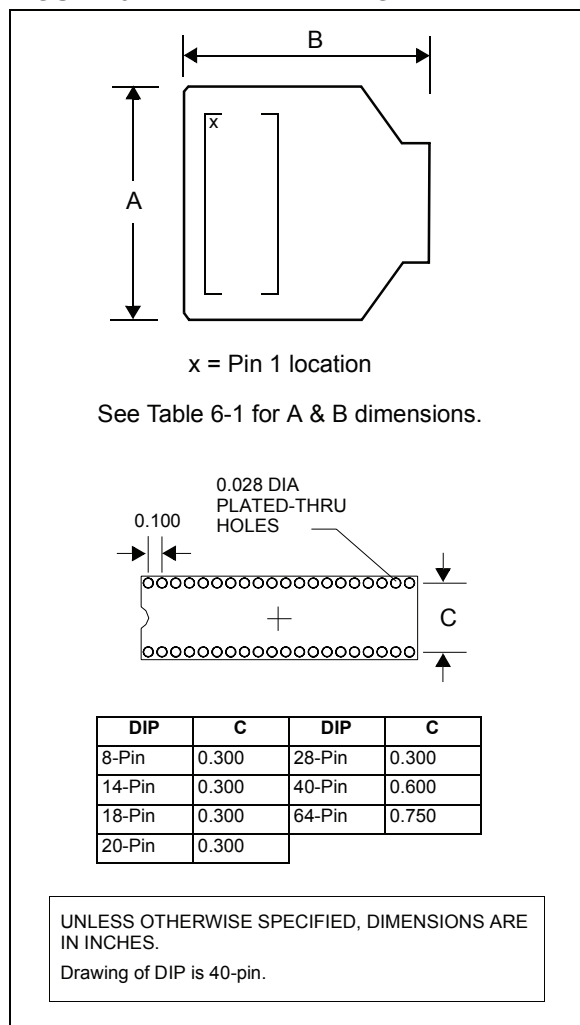

TABLE 6-1: DVA DIMENSIONS – DIP

Package	DVA Number*	A	B
8P/14P DIP	DVA1002	1.700	2.100
8P/14P/20P DIP	DVA1004	1.700	2.425
8P DIP	DVA12XP080	2.200	1.650
8P DIP	DVA12XP081	2.200	1.650
14P DIP	DVA16XP140	2.200	1.650
14P DIP	DVA16XP141	2.000	2.100
18P DIP	DVA16XP180	2.200	1.650
18P DIP	DVA16XP182	2.000	2.100
18P DIP	DVA16XP183	2.150	2.575
18P DIP	DVA16XP185	2.150	2.000
18P DIP	DVA16XP186	2.000	2.100
18P DIP	DVA16XP187	2.000	2.100
18P DIP	DVA18XP180	2.150	2.575
20P DIP	DVA16XP200	2.150	2.575
20P DIP	DVA16XP201	2.150	1.825
20P DIP	DVA16XP202	2.200	2.675
28P DIP	DVA14XP280	2.200	1.700
28P DIP	DVA16XP280	2.200	1.700
28P DIP	DVA16XP282	2.000	2.100
28P DIP	DVA18XP280	2.000	2.100
40P DIP	DVA16XP401	2.200	2.200
40P DIP	DVA17XP401	2.200	2.000
40P DIP	DVA18XP400	2.200	2.200
64P DIP	DVA16XP640	2.500	2.050

* See the MPLAB® ICE 2000 Readme file for information on devices supported by each DVA.

Processor Module and Device Adapter Specification

6.2 TQFP/PLCC Device Footprints

TQFP/PLCC device adapter footprints shown will accept board stackers like Samtec series DWM 0.050 Pitch Stackers. These stackers can be soldered in place during development/emulation and eliminate the need for any other sockets.

FIGURE 6-2: DVA DRAWING – SINGLE-ROW TQFP/PLCC

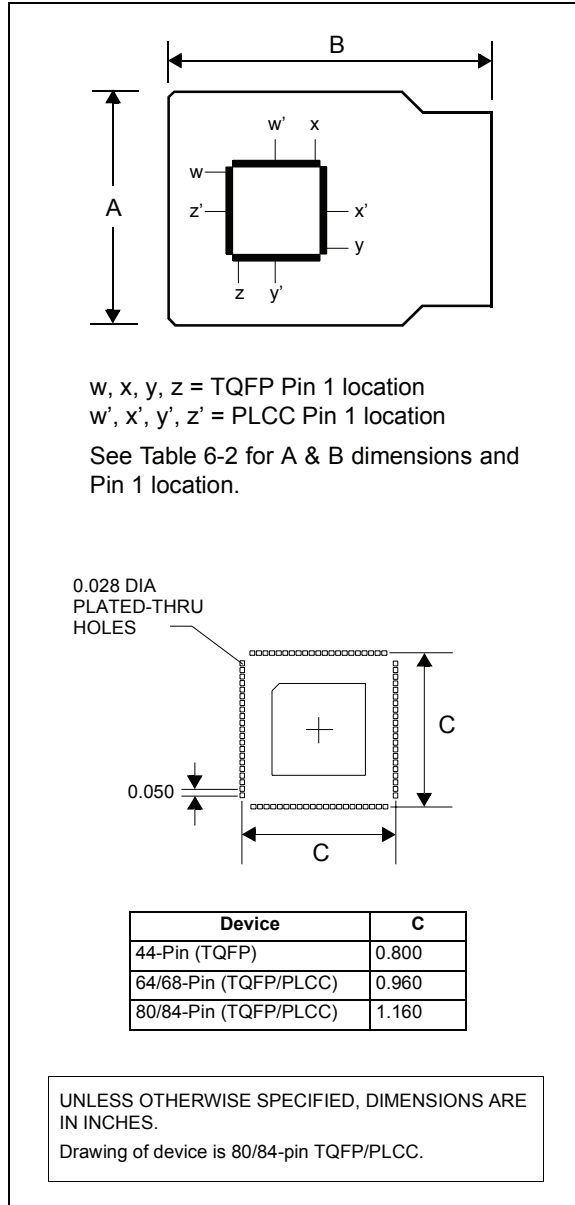
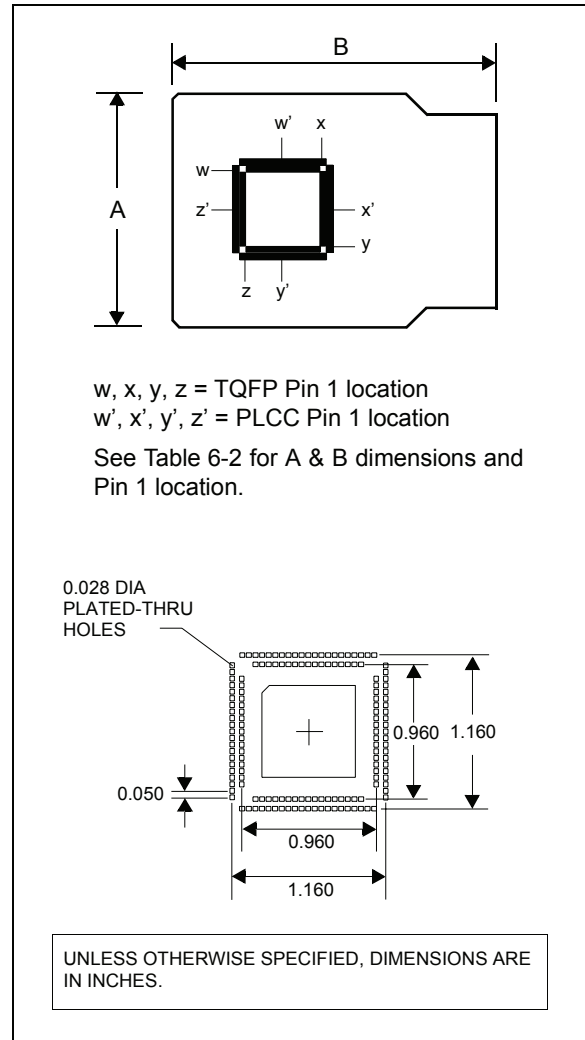

FIGURE 6-3: DVA DRAWING – DOUBLE-ROW TQFP/PLCC



MPLAB® ICE 2000

Device adapter pin-out matches the PLCC package. PLCC will map to TQFP as follows:

- DVA-44PL interface to 44-pin TQFP – one-to-one mapping. (No mapping diagram needed.)
- DVA-68PL interface to 64-pin TQFP – see Figure 6-4 for mapping.
- DVA-68PL2 interface to 64-pin TQFP – see Figure 6-5 for mapping.
- DVA-84PL interface to 80-pin TQFP – see Figure 6-6 for mapping.

TABLE 6-2: DVA DIMENSIONS – PLCC/TQFP

Package	DVA Number*	Mapping	Rows	A	B	Pin 1
44P PLCC	DVA16XL441	DVA – 44PL	Single	2.200	2.200	w'
44P PLCC	DVA17XL441	DVA – 44PL	Single	1.850	2.100	z'
68P PLCC	DVA16XL680	DVA – 68PL2	Single	1.850	2.100	z'
68P PLCC	DVA17XL681	DVA – 68PL	Single	1.850	2.500	z'
68P PLCC	DVA18XL680	DVA – 68PL	Single	2.050	2.575	y'
84P PLCC	DVA17XL841	DVA – 84PL	Single	2.150	2.575	z'
84P PLCC	DVA18XL840	DVA – 84PL	Single	2.200	2.675	y'
44P TQFP	DVA16PQ441	DVA – 44PL	Single	2.200	2.300	y
44P TQFP	DVA17PQ441	DVA – 44PL	Single	1.950	2.200	x
44P TQFP	DVA18PQ440	DVA – 44PL	Single	2.200	2.300	y
64P TQFP	DVA16PQ640	DVA – 68PL2	Single	1.850	2.100	z
64P TQFP	DVA17PQ641	DVA – 68PL	Single	1.850	2.500	z
64P TQFP	DVA18PQ640	DVA – 68PL	Single	2.050	2.575	y
64P TQFP	DVA1005	DVA – 68PL	Single	2.200	2.875	y
80P TQFP	DVA17PQ801	DVA – 84PL	Single	2.150	2.575	z
80P TQFP	DVA18PQ800	DVA – 84PL	Single	2.200	2.675	y
68/84P PLCC, 64/80P TQFP	DVA18PQ802	DVA – 68PL DVA – 84PL	Double	2.200	2.675	y', y
68/84P PLCC, 64/80P TQFP	DVA1003	DVA – 68PL DVA – 84PL	Double	2.200	2.975	y', y

* See the MPLAB® ICE 2000 Readme file for information on devices supported by each DVA.

Processor Module and Device Adapter Specification

FIGURE 6-4: DVA-68PL TO 64-PIN TQFP

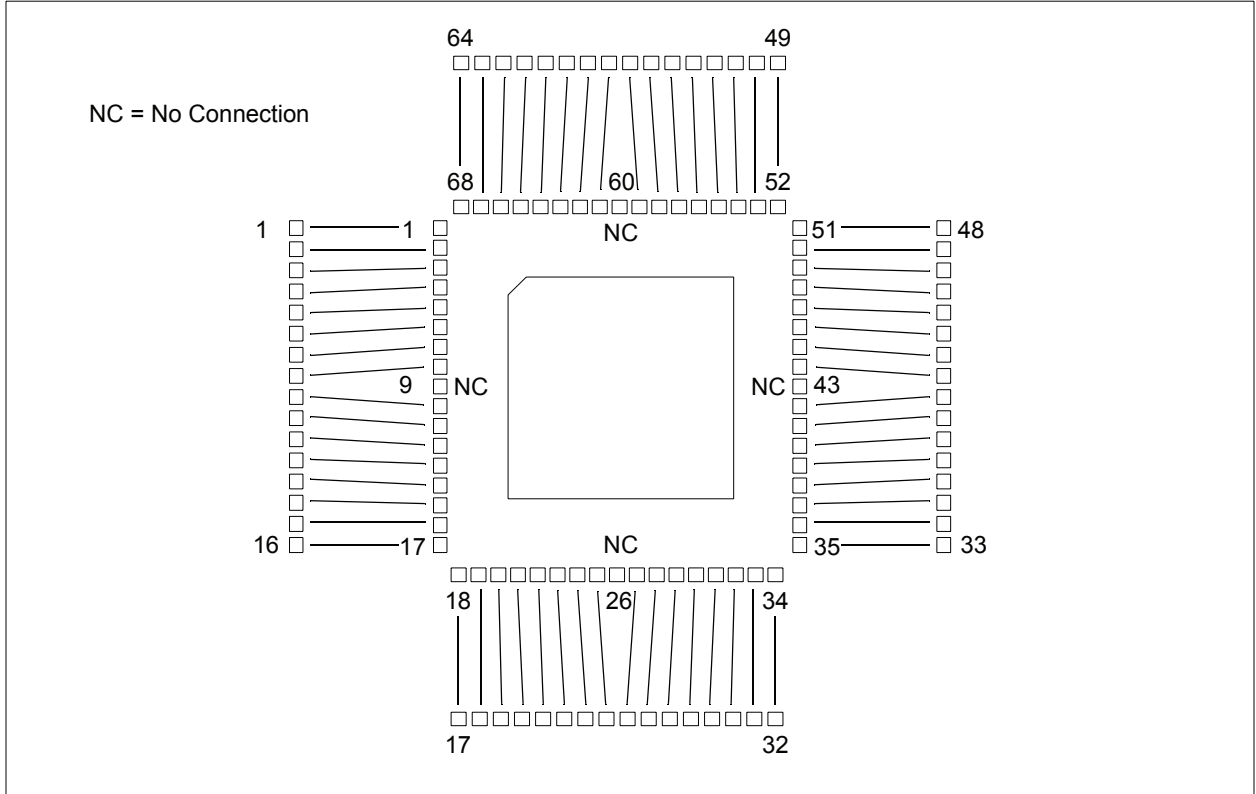

FIGURE 6-5: DVA-68PL2 TO 64-PIN TQFP

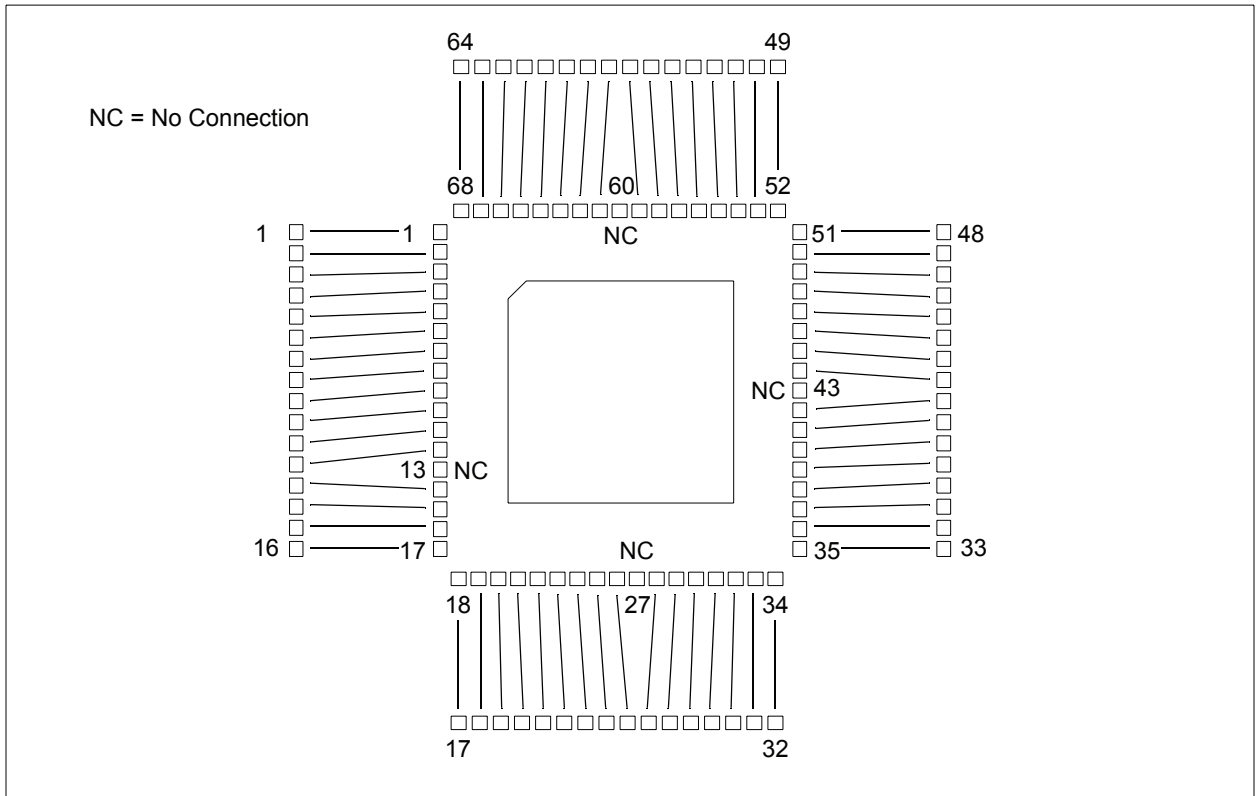
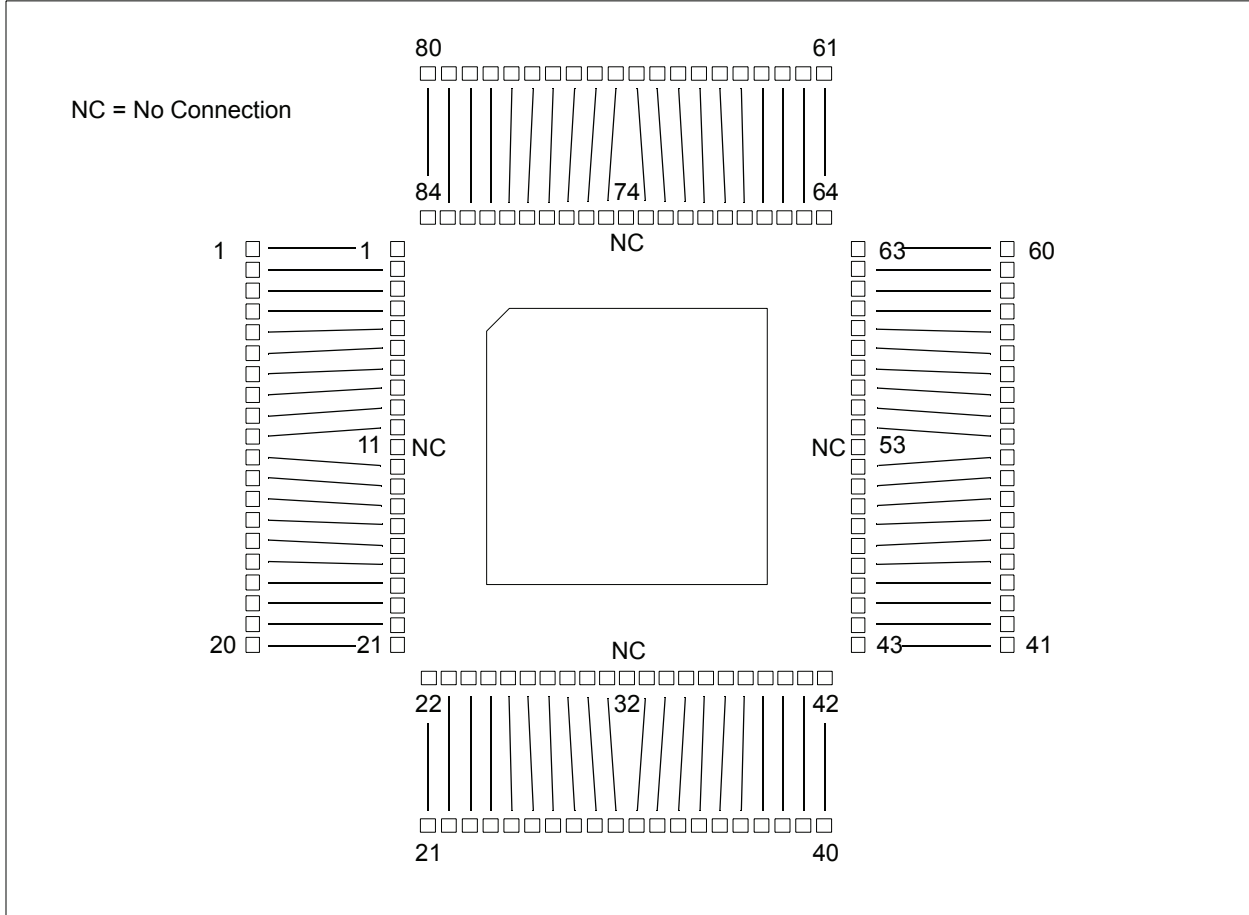

FIGURE 6-6: DVA-84PL TO 80-PIN TQFP



Processor Module and Device Adapter Specification

APPENDIX A: REVISION HISTORY

Revision M (March 2006)

- Updated Table 5-2.

MPLAB® ICE 2000

NOTES:

Note the following details of the code protection feature on Microchip devices:

- Microchip products meet the specification contained in their particular Microchip Data Sheet.
- Microchip believes that its family of products is one of the most secure families of its kind on the market today, when used in the intended manner and under normal conditions.
- There are dishonest and possibly illegal methods used to breach the code protection feature. All of these methods, to our knowledge, require using the Microchip products in a manner outside the operating specifications contained in Microchip's Data Sheets. Most likely, the person doing so is engaged in theft of intellectual property.
- Microchip is willing to work with the customer who is concerned about the integrity of their code.
- Neither Microchip nor any other semiconductor manufacturer can guarantee the security of their code. Code protection does not mean that we are guaranteeing the product as "unbreakable."

Code protection is constantly evolving. We at Microchip are committed to continuously improving the code protection features of our products. Attempts to break Microchip's code protection feature may be a violation of the Digital Millennium Copyright Act. If such acts allow unauthorized access to your software or other copyrighted work, you may have a right to sue for relief under that Act.

Information contained in this publication regarding device applications and the like is provided only for your convenience and may be superseded by updates. It is your responsibility to ensure that your application meets with your specifications. MICROCHIP MAKES NO REPRESENTATIONS OR WARRANTIES OF ANY KIND WHETHER EXPRESS OR IMPLIED, WRITTEN OR ORAL, STATUTORY OR OTHERWISE, RELATED TO THE INFORMATION, INCLUDING BUT NOT LIMITED TO ITS CONDITION, QUALITY, PERFORMANCE, MERCHANTABILITY OR FITNESS FOR PURPOSE. Microchip disclaims all liability arising from this information and its use. Use of Microchip devices in life support and/or safety applications is entirely at the buyer's risk, and the buyer agrees to defend, indemnify and hold harmless Microchip from any and all damages, claims, suits, or expenses resulting from such use. No licenses are conveyed, implicitly or otherwise, under any Microchip intellectual property rights.

Trademarks

The Microchip name and logo, the Microchip logo, Accuron, dsPIC, KEELOQ, microID, MPLAB, PIC, PICmicro, PICSTART, PRO MATE, PowerSmart, rPIC, and SmartShunt are registered trademarks of Microchip Technology Incorporated in the U.S.A. and other countries.

AmpLab, FilterLab, Migratable Memory, MXDEV, MXLAB, SEEVAL, SmartSensor and The Embedded Control Solutions Company are registered trademarks of Microchip Technology Incorporated in the U.S.A.

Analog-for-the-Digital Age, Application Maestro, dsPICDEM, dsPICDEM.net, dsPICworks, ECAN, ECONOMONITOR, FanSense, FlexROM, fuzzyLAB, In-Circuit Serial Programming, ICSP, ICEPIC, Linear Active Thermistor, MPASM, MPLIB, MPLINK, MPSIM, PICkit, PICDEM, PICDEM.net, PICLAB, PICtail, PowerCal, PowerInfo, PowerMate, PowerTool, REAL ICE, rFLAB, rPICDEM, Select Mode, Smart Serial, SmartTel, Total Endurance, UNI/O, WiperLock and Zena are trademarks of Microchip Technology Incorporated in the U.S.A. and other countries.

SQTP is a service mark of Microchip Technology Incorporated in the U.S.A.

All other trademarks mentioned herein are property of their respective companies.

© 2006, Microchip Technology Incorporated, Printed in the U.S.A., All Rights Reserved.

 Printed on recycled paper.

**QUALITY MANAGEMENT SYSTEM
CERTIFIED BY DNV
== ISO/TS 16949:2002 ==**

Microchip received ISO/TS-16949:2002 quality system certification for its worldwide headquarters, design and wafer fabrication facilities in Chandler and Tempe, Arizona and Mountain View, California in October 2003. The Company's quality system processes and procedures are for its PICmicro® 8-bit MCUs, KEELOQ® code hopping devices, Serial EEPROMs, microperipherals, nonvolatile memory and analog products. In addition, Microchip's quality system for the design and manufacture of development systems is ISO 9001:2000 certified.



WORLDWIDE SALES AND SERVICE

AMERICAS

Corporate Office
2355 West Chandler Blvd.
Chandler, AZ 85224-6199
Tel: 480-792-7200
Fax: 480-792-7277
Technical Support:
<http://support.microchip.com>
Web Address:
www.microchip.com

Atlanta
Alpharetta, GA
Tel: 770-640-0034
Fax: 770-640-0307

Boston
Westborough, MA
Tel: 774-760-0087
Fax: 774-760-0088

Chicago
Itasca, IL
Tel: 630-285-0071
Fax: 630-285-0075

Dallas
Addison, TX
Tel: 972-818-7423
Fax: 972-818-2924

Detroit
Farmington Hills, MI
Tel: 248-538-2250
Fax: 248-538-2260

Kokomo
Kokomo, IN
Tel: 765-864-8360
Fax: 765-864-8387

Los Angeles
Mission Viejo, CA
Tel: 949-462-9523
Fax: 949-462-9608

San Jose
Mountain View, CA
Tel: 650-215-1444
Fax: 650-961-0286

Toronto
Mississauga, Ontario,
Canada
Tel: 905-673-0699
Fax: 905-673-6509

ASIA/PACIFIC

Australia - Sydney
Tel: 61-2-9868-6733
Fax: 61-2-9868-6755

China - Beijing
Tel: 86-10-8528-2100
Fax: 86-10-8528-2104

China - Chengdu
Tel: 86-28-8676-6200
Fax: 86-28-8676-6599

China - Fuzhou
Tel: 86-591-8750-3506
Fax: 86-591-8750-3521

China - Hong Kong SAR
Tel: 852-2401-1200
Fax: 852-2401-3431

China - Qingdao
Tel: 86-532-8502-7355
Fax: 86-532-8502-7205

China - Shanghai
Tel: 86-21-5407-5533
Fax: 86-21-5407-5066

China - Shenyang
Tel: 86-24-2334-2829
Fax: 86-24-2334-2393

China - Shenzhen
Tel: 86-755-8203-2660
Fax: 86-755-8203-1760

China - Shunde
Tel: 86-757-2839-5507
Fax: 86-757-2839-5571

China - Wuhan
Tel: 86-27-5980-5300
Fax: 86-27-5980-5118

China - Xian
Tel: 86-29-8833-7250
Fax: 86-29-8833-7256

ASIA/PACIFIC

India - Bangalore
Tel: 91-80-4182-8400
Fax: 91-80-4182-8422

India - New Delhi
Tel: 91-11-5160-8631
Fax: 91-11-5160-8632

India - Pune
Tel: 91-20-2566-1512
Fax: 91-20-2566-1513

Japan - Yokohama
Tel: 81-45-471- 6166
Fax: 81-45-471-6122

Korea - Gumi
Tel: 82-54-473-4301
Fax: 82-54-473-4302

Korea - Seoul
Tel: 82-2-554-7200
Fax: 82-2-558-5932 or
82-2-558-5934

Malaysia - Penang
Tel: 60-4-646-8870
Fax: 60-4-646-5086

Philippines - Manila
Tel: 63-2-634-9065
Fax: 63-2-634-9069

Singapore
Tel: 65-6334-8870
Fax: 65-6334-8850

Taiwan - Hsin Chu
Tel: 886-3-572-9526
Fax: 886-3-572-6459

Taiwan - Kaohsiung
Tel: 886-7-536-4818
Fax: 886-7-536-4803

Taiwan - Taipei
Tel: 886-2-2500-6610
Fax: 886-2-2508-0102

Thailand - Bangkok
Tel: 66-2-694-1351
Fax: 66-2-694-1350

EUROPE

Austria - Wels
Tel: 43-7242-2244-399
Fax: 43-7242-2244-393

Denmark - Copenhagen
Tel: 45-4450-2828
Fax: 45-4485-2829

France - Paris
Tel: 33-1-69-53-63-20
Fax: 33-1-69-30-90-79

Germany - Munich
Tel: 49-89-627-144-0
Fax: 49-89-627-144-44

Italy - Milan
Tel: 39-0331-742611
Fax: 39-0331-466781

Netherlands - Drunen
Tel: 31-416-690399
Fax: 31-416-690340

Spain - Madrid
Tel: 34-91-708-08-90
Fax: 34-91-708-08-91

UK - Wokingham
Tel: 44-118-921-5869
Fax: 44-118-921-5820



02/16/06

X-ON Electronics

Largest Supplier of Electrical and Electronic Components

Click to view similar products for [Sockets & Adapters](#) category:

Click to view products by [Microchip](#) manufacturer:

Other Similar products are found below :

[6508-0-00-01-00-00-33-0](#) [AC164341](#) [AC164348](#) [1262](#) [C8051F350-TB](#) [KITPF0100SKTEVBE](#) [LFVDBJR](#) [SK-AX2-CQ256-KITTOP](#)
[AC164334](#) [AC164353](#) [AC164383](#) [SOCKET-ADM106XTQZ](#) [SPC564A80CAL176](#) [ST5M1267-001](#) [FP3-10PIN-ADAPTER-KIT](#) [CY3675-](#)
[LCC4A](#) [TDGL015](#) [ATF15XXDK3-SAA100](#) [LFBGADATC](#) [SM64TQ-ACTEL-1](#) [SM68P-ACTEL](#) [8.06.03](#) [AC164358](#) [ATSTK600-RC99](#)
[76002056](#) [DS91230+](#) [OM13019,598](#) [09185058](#) [AC164369](#) [AC164409](#) [AC164402](#) [SMPA-ISP-ACTEL-3-KIT](#) [ICESABCM81-01](#) [LFVDBGF](#)
[AC164408](#) [LFBGADAU1A](#) [KIT 70601-3](#) [S5U13U00P00C100](#) [AC164352](#) [PN-Q208/5256V](#) [PN-T100/LC4256](#) [LFBGAINTM55U1QA](#)
[AC164370](#) [AC164355](#) [AC164367](#) [LFDAS12XEFT](#) [CY3675-TSSOP20B](#) [SPC563M64AVB144](#) [ATF15XXDK3-SAA44](#) [AC164410](#)