



MICROCHIP

**EVB-USB5744
Evaluation Board
User's Guide**

Note the following details of the code protection feature on Microchip devices:

- Microchip products meet the specification contained in their particular Microchip Data Sheet.
- Microchip believes that its family of products is one of the most secure families of its kind on the market today, when used in the intended manner and under normal conditions.
- There are dishonest and possibly illegal methods used to breach the code protection feature. All of these methods, to our knowledge, require using the Microchip products in a manner outside the operating specifications contained in Microchip's Data Sheets. Most likely, the person doing so is engaged in theft of intellectual property.
- Microchip is willing to work with the customer who is concerned about the integrity of their code.
- Neither Microchip nor any other semiconductor manufacturer can guarantee the security of their code. Code protection does not mean that we are guaranteeing the product as “unbreakable.”

Code protection is constantly evolving. We at Microchip are committed to continuously improving the code protection features of our products. Attempts to break Microchip's code protection feature may be a violation of the Digital Millennium Copyright Act. If such acts allow unauthorized access to your software or other copyrighted work, you may have a right to sue for relief under that Act.

Information contained in this publication regarding device applications and the like is provided only for your convenience and may be superseded by updates. It is your responsibility to ensure that your application meets with your specifications. MICROCHIP MAKES NO REPRESENTATIONS OR WARRANTIES OF ANY KIND WHETHER EXPRESS OR IMPLIED, WRITTEN OR ORAL, STATUTORY OR OTHERWISE, RELATED TO THE INFORMATION, INCLUDING BUT NOT LIMITED TO ITS CONDITION, QUALITY, PERFORMANCE, MERCHANTABILITY OR FITNESS FOR PURPOSE. Microchip disclaims all liability arising from this information and its use. Use of Microchip devices in life support and/or safety applications is entirely at the buyer's risk, and the buyer agrees to defend, indemnify and hold harmless Microchip from any and all damages, claims, suits, or expenses resulting from such use. No licenses are conveyed, implicitly or otherwise, under any Microchip intellectual property rights unless otherwise stated.

Trademarks

The Microchip name and logo, the Microchip logo, dsPIC, FlashFlex, flexPWR, JukeBlox, KEELOQ, KEELOQ logo, Kleer, LANCheck, MediaLB, MOST, MOST logo, MPLAB, OptoLyzer, PIC, PICSTART, PIC³² logo, RightTouch, SpyNIC, SST, SST Logo, SuperFlash and UNI/O are registered trademarks of Microchip Technology Incorporated in the U.S.A. and other countries.

The Embedded Control Solutions Company and mTouch are registered trademarks of Microchip Technology Incorporated in the U.S.A.

Analog-for-the-Digital Age, BodyCom, chipKIT, chipKIT logo, CodeGuard, dsPICDEM, dsPICDEM.net, ECAN, In-Circuit Serial Programming, ICSP, Inter-Chip Connectivity, KleerNet, KleerNet logo, MiWi, MPASM, MPF, MPLAB Certified logo, MPLIB, MPLINK, MultiTRAK, NetDetach, Omniscient Code Generation, PICDEM, PICDEM.net, PICKit, PICTail, RightTouch logo, REAL ICE, SQI, Serial Quad I/O, Total Endurance, TSHARC, USBCheck, VariSense, ViewSpan, WiperLock, Wireless DNA, and ZENA are trademarks of Microchip Technology Incorporated in the U.S.A. and other countries.

SQTP is a service mark of Microchip Technology Incorporated in the U.S.A.

Silicon Storage Technology is a registered trademark of Microchip Technology Inc. in other countries.

GestIC is a registered trademarks of Microchip Technology Germany II GmbH & Co. KG, a subsidiary of Microchip Technology Inc., in other countries.

All other trademarks mentioned herein are property of their respective companies.

© 2015, Microchip Technology Incorporated, Printed in the U.S.A., All Rights Reserved.

ISBN: 9781632776631

**QUALITY MANAGEMENT SYSTEM
CERTIFIED BY DNV
= ISO/TS 16949 =**

Microchip received ISO/TS-16949:2009 certification for its worldwide headquarters, design and wafer fabrication facilities in Chandler and Tempe, Arizona; Gresham, Oregon and design centers in California and India. The Company's quality system processes and procedures are for its PIC[®] MCUs and dsPIC[®] DSCs, KEELOQ[®] code hopping devices, Serial EEPROMs, microperipherals, nonvolatile memory and analog products. In addition, Microchip's quality system for the design and manufacture of development systems is ISO 9001:2000 certified.

Object of Declaration: EVB-USB5744 Evaluation Board

EU Declaration of Conformity

Manufacturer: Microchip Technology Inc.
2355 W. Chandler Blvd.
Chandler, Arizona, 85224-6199
USA

This declaration of conformity is issued by the manufacturer.

The development/evaluation tool is designed to be used for research and development in a laboratory environment. This development/evaluation tool is not a Finished Appliance, nor is it intended for incorporation into Finished Appliances that are made commercially available as single functional units to end users under EU EMC Directive 2004/108/EC and as supported by the European Commission's Guide for the EMC Directive 2004/108/EC (8th February 2010).

This development/evaluation tool complies with EU RoHS2 Directive 2011/65/EU.

This development/evaluation tool, when incorporating wireless and radio-telecom functionality, is in compliance with the essential requirement and other relevant provisions of the R&TTE Directive 1999/5/EC and the FCC rules as stated in the declaration of conformity provided in the module datasheet and the module product page available at www.microchip.com.

For information regarding the exclusive, limited warranties applicable to Microchip products, please see Microchip's standard terms and conditions of sale, which are printed on our sales documentation and available at www.microchip.com.

Signed for and on behalf of Microchip Technology Inc. at Chandler, Arizona, USA

Derek Carlson
VP Development Tools

12-Sep-14
Date

NOTES:

Table of Contents

Preface	6
Introduction.....	6
Document Layout	6
Conventions Used in this Guide	7
The Microchip Web Site	8
Development Systems Customer Change Notification Service	8
Customer Support	8
Document Revision History	9
 Chapter 1. Overview	
1.1 Introduction	10
 Chapter 2. Getting Started	
2.1 Configuration	11
2.1.1 External SPI Flash	11
2.1.2 SMBus	12
2.1.3 Configuration Source - Internal Default	12
2.1.4 Strapping Option	12
2.1.5 Port Power Options: Port Enable and Port Disable Select	13
2.2 Power Source - Self-Powered	14
2.3 Downstream Port Power Control	14
 Appendix A. EVB-USB5744 Evaluation Board	
A.1 Introduction	15
 Appendix B. EVB-USB5744 Evaluation Board Schematics	
B.1 Introduction	16
 Appendix C. Bill of Materials (BOM)	
C.1 Introduction	19
 Appendix D. EVB-USB5744 Silk Screens	
D.1 Introduction	22
 Worldwide Sales and Service	24

Preface

NOTICE TO CUSTOMERS

All documentation becomes dated, and this manual is no exception. Microchip tools and documentation are constantly evolving to meet customer needs, so some actual dialogs and/or tool descriptions may differ from those in this document. Please refer to our web site (www.microchip.com) to obtain the latest documentation available.

Documents are identified with a “DS” number. This number is located on the bottom of each page, in front of the page number. The numbering convention for the DS number is “DSXXXXA”, where “XXXX” is the document number and “A” is the revision level of the document.

For the most up-to-date information on development tools, see the MPLAB® IDE online help. Select the Help menu, and then Topics to open a list of available online help files.

INTRODUCTION

This chapter contains general information that will be useful to know before using the EVB-USB5744 Evaluation Board. Items discussed in this chapter include:

- [Document Layout](#)
- [Conventions Used in this Guide](#)
- [The Microchip Web Site](#)
- [Development Systems Customer Change Notification Service](#)
- [Customer Support](#)
- [Document Revision History](#)

DOCUMENT LAYOUT

This document describes how to use the EVB-USB5744 Evaluation Board as a development tool for the USB5744 4 port USB 3.1 Gen 1 hub with battery charging features.

- **Chapter 1. “Overview”** – Shows a brief description of the EVB-USB5744 Evaluation Board.
- **Chapter 2. “Getting Started”** – Includes instructions on how to get started with the EVB-USB5744 Evaluation Board.
- **Appendix A. “EVB-USB5744 Evaluation Board”** – This appendix shows the EVB-USB5744 Evaluation Board.
- **Appendix B. “EVB-USB5744 Evaluation Board Schematics”** – This appendix shows the EVB-USB5744 Evaluation Board schematics.
- **Appendix C. “Bill of Materials (BOM)”** – This appendix includes the EVB-USB5744 Evaluation Board Bill of Materials (BOM).
- **Appendix D. “EVB-USB5744 Silk Screens”** – This appendix includes the EVB-USB5744 Evaluation Board silk screens.

CONVENTIONS USED IN THIS GUIDE

This manual uses the following documentation conventions:

DOCUMENTATION CONVENTIONS

Description	Represents	Examples
Arial font:		
Italic characters	Referenced books	<i>MPLAB[®] IDE User's Guide</i>
	Emphasized text	...is the <i>only</i> compiler...
Initial caps	A window	the Output window
	A dialog	the Settings dialog
	A menu selection	select Enable Programmer
Quotes	A field name in a window or dialog	"Save project before build"
Underlined, italic text with right angle bracket	A menu path	<u><i>File>Save</i></u>
Bold characters	A dialog button	Click OK
	A tab	Click the Power tab
N'Rnnnn	A number in verilog format, where N is the total number of digits, R is the radix and n is a digit.	4'b0010, 2'hF1
Text in angle brackets < >	A key on the keyboard	Press <Enter>, <F1>
Courier New font:		
Plain Courier New	Sample source code	#define START
	Filenames	autoexec.bat
	File paths	c:\mcc18\h
	Keywords	_asm, _endasm, static
	Command-line options	-Opa+, -Opa-
	Bit values	0, 1
	Constants	0xFF, 'A'
Italic Courier New	A variable argument	<i>file.o</i> , where <i>file</i> can be any valid filename
Square brackets []	Optional arguments	mcc18 [options] <i>file</i> [options]
Curly brackets and pipe character: { }	Choice of mutually exclusive arguments; an OR selection	errorlevel {0 1}
Ellipses...	Replaces repeated text	var_name [, var_name...]
	Represents code supplied by user	void main (void) { ... }

THE MICROCHIP WEB SITE

Microchip provides online support via our web site at www.microchip.com. This web site is used as a means to make files and information easily available to customers. Accessible by using your favorite Internet browser, the web site contains the following information:

- **Product Support** – Data sheets and errata, application notes and sample programs, design resources, user's guides and hardware support documents, latest software releases and archived software
- **General Technical Support** – Frequently Asked Questions (FAQs), technical support requests, online discussion groups, Microchip consultant program member listing
- **Business of Microchip** – Product selector and ordering guides, latest Microchip press releases, listing of seminars and events, listings of Microchip sales offices, distributors and factory representatives

DEVELOPMENT SYSTEMS CUSTOMER CHANGE NOTIFICATION SERVICE

Microchip's customer notification service helps keep customers current on Microchip products. Subscribers will receive e-mail notification whenever there are changes, updates, revisions or errata related to a specified product family or development tool of interest.

To register, access the Microchip web site at www.microchip.com, click on Customer Change Notification and follow the registration instructions.

The Development Systems product group categories are:

- **Compilers** – The latest information on Microchip C compilers, assemblers, linkers and other language tools. These include all MPLAB C compilers; all MPLAB assemblers (including MPASM assembler); all MPLAB linkers (including MPLINK object linker); and all MPLAB librarians (including MPLIB object librarian).
- **Emulators** – The latest information on Microchip in-circuit emulators. This includes the MPLAB REAL ICE and MPLAB ICE 2000 in-circuit emulators.
- **In-Circuit Debuggers** – The latest information on the Microchip in-circuit debuggers. This includes MPLAB ICD 3 in-circuit debuggers and PICkit 3 debug express.
- **MPLAB IDE** – The latest information on Microchip MPLAB IDE, the Windows Integrated Development Environment for development systems tools. This list is focused on the MPLAB IDE, MPLAB IDE Project Manager, MPLAB Editor and MPLAB SIM simulator, as well as general editing and debugging features.
- **Programmers** – The latest information on Microchip programmers. These include production programmers such as MPLAB REAL ICE in-circuit emulator, MPLAB ICD 3 in-circuit debugger and MPLAB PM3 device programmers. Also included are nonproduction development programmers such as PICSTART Plus and PIC-kit 2 and 3.

CUSTOMER SUPPORT

Users of Microchip products can receive assistance through several channels:

- Distributor or Representative
- Local Sales Office
- Field Application Engineer (FAE)
- Technical Support

Customers should contact their distributor, representative or field application engineer (FAE) for support. Local sales offices are also available to help customers. A listing of sales offices and locations is included in the back of this document.

Technical support is available through the web site at:

<http://www.microchip.com/support>

DOCUMENT REVISION HISTORY

Revision	Section/Figure/Entry	Correction
DS50002306B (08-06-15)	Updated "USB 3.0" references to "USB 3.1 Gen 1" throughout document	
REV A - December 2014		Initial release of document

Chapter 1. Overview

1.1 INTRODUCTION

The EVB-USB5744 Revision A is a demonstration and evaluation platform that provides the necessary requirements and interface options for evaluating the USB5744 Ultra Fast four port battery charging hub on a 4-layer RoHS-compliant Printed Circuit Board (PCB). This will allow the user to gain an understanding of the product and accelerate the integration of the EVB-USB5744 into the user's design. The EVB-USB5744 is compliant with the USB 3.1 Specification and supports SuperSpeed (SS), High-Speed (HS), Full-Speed (FS), and Low-Speed (LS) USB signaling for complete coverage of all defined USB operation speeds. The evaluation platform supports four downstream ports that are USB 2.0 and USB 3.1 Gen 1 compliant. The EVB-USB5744 platform also supports battery charging on all four downstream ports (maximum of 5A at any one time). The EVB-USB5744 is configured for operation through internal default settings and supports custom configurations through SMBus or through the external 64-Mbit SPI Flash device, U8. The EVB-USB5744 demonstrates driver compatibility with Microsoft® Windows® 8x, Windows 7, Windows XP, Mac OS® X 10.4+, and Linux® hub drivers.

The EVB-USB5744 provides the following features:

- USB5744 in a 56-pin QFN RoHS compliant package
- USB 3.1 Gen 1 compliant (SS, HS, FS, and LS operation)
- USB pins are 5 V tolerant
- Self powered operation
- Four downstream USB 2.0/ USB 3.1 Gen 1 ports
- All downstream ports support individual port power and overcurrent sense
- All downstream ports are battery charge enabled (2.1A max per port)
- Can support up to 5A down stream Port Power at any one time
- Onboard SPI Flash for external downloadable firmware
- Low-cost 4-layer space saving design
- Operates from a single voltage (+12.0 V, regulated) external power supply
- Onboard 25 MHz crystal or external clock input
- Single onboard +5.25 V, 6 Amp regulator
- Single onboard +3.3 V, 0.5 Amp regulator
- Single onboard +1.2 V, 1 Amp regulator
- Port Power and Port Enable LED indicators
- LED indicators for SPI/Strap Configuration

Chapter 2. Getting Started

The Microchip EVB-USB5744 is designed for flexible configuration solutions. It can be configured via default internal register settings, downloadable external firmware to an onboard SPI Flash, through SMBus, or through the onboard configuration switches. When configured with the default internal register settings, the device operates as a USB 3.1 Gen 1 / USB 2.0 hub with four battery charge enabled USB ports and Microchip's standard VID/PID/DID settings.

2.1 CONFIGURATION

2.1.1 External SPI Flash

Upon power-up, the USB5744 first looks for an external SPI Flash device and a valid signature in the flash. If one is found, the external ROM is enabled and code execution is initiated from the external SPI device.

To select the SPI device, set the Config. Select switch to "SPI", position 1-2. The blue LED will light. Note that the CFG_BC and CFG_Non-Rem options are now de-selected. All configuration in SPI mode is done by the SPI.

Note: If the SPI Flash is not properly programmed or has an invalid signature, the USB5744 will default to internal defaults even if the SPI Flash is selected.

FIGURE 2-1: SPI SELECT

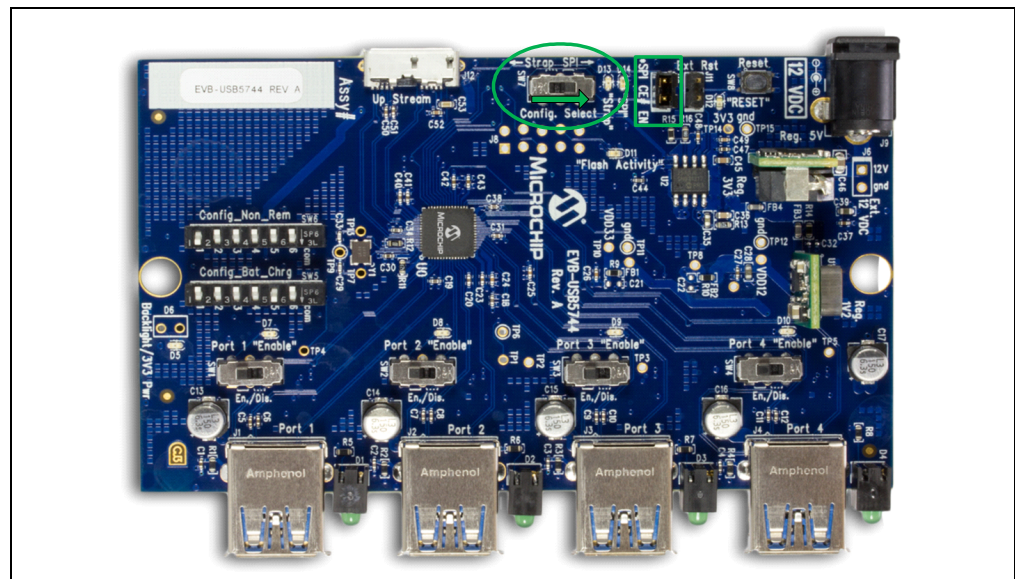

The 10 k Ω pull-up resistors (R42 and R58) on the SPI device's Write Protect (WPn) and Hold (HOLDn) pins must also be populated in order to use external flash. The 10 k Ω pull-up resistor (R61) on the SPI_CE_N pin of the USB5744 must also be populated in order to select 60MHz SPI operation, as opposed to 30MHz operation. Additionally there must be a jumper placed on

J10 in order to enable the SPI device. The external flash can be programmed using the Microchip ProTouch MPT software tool which can be downloaded from the Microchip website at <http://www.Microchip.com/ProTouch>.

Note: Refer to the Protouch MPT User Manual on using this software to program the configuration.

2.1.2 SMBus

If an SPI Flash device is not found, the firmware checks if the SMBus is enabled. The SMBus can operate in either legacy mode (USB 2.0 only) or advanced mode (access to both USB 2.0 and USB 3.1 Gen 1 registers). When using SMBus, the default configuration is for it to run in the advanced mode.

To select SMBus configuration, set the Config. Select switch to "Strap", position 2-3. The green LED will light.

The SMBus must have correct pull up resistors applied by external circuitry to function properly. The SMBus signals may be accessed at J8, pins 1 and 3.

Remember, if configured for SMBus operation the USB5744 will wait indefinitely for data from the SMBus.

FIGURE 2-2: SMBUS SELECT

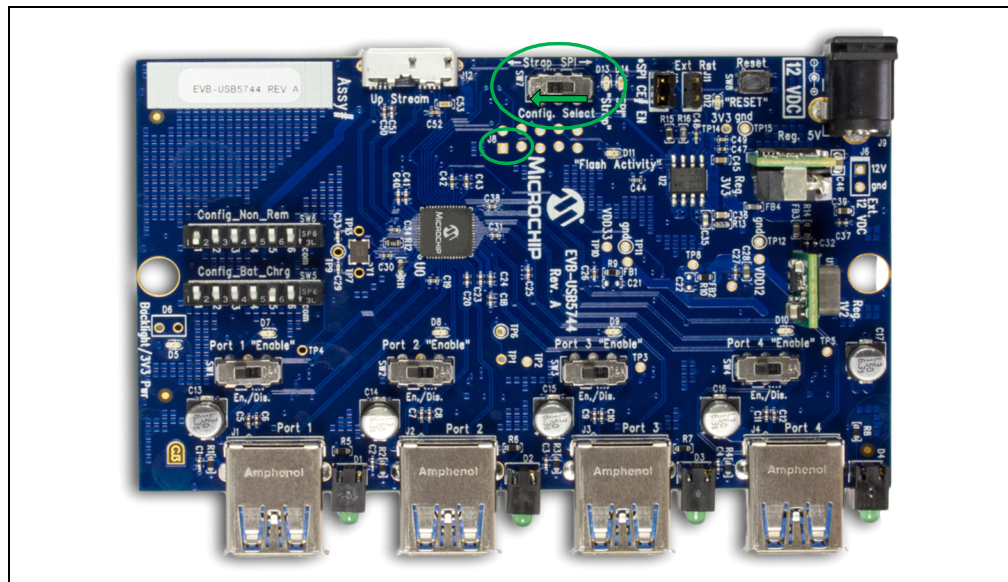

2.1.3 Configuration Source - Internal Default

When the USB5744 does not detect a valid SPI Flash image or SMBus configuration upon power-up, the EVB-USB5744 uses internal default register settings. It also sets the Vendor ID, Product ID, Language ID, and Device ID, and additional settings from internal ROM code.

2.1.4 Strapping Option

If configuration is not done through SPI, additional configuration is available through two functions: CFG_BC and CFG_Non-Rem. The controls are configured by selecting one of six resistor values for each pin. These are read by the USB5744 device and the BC and Non-Rem behavior of the downstream facing ports are determined.

To use the strapping option, set the Config. Select switch to "Strap", position 2-3. The green LED will light. Select the desired CFG_BC and CFG_Non-Rem options by enabling only one position for each of the Config_Bat_Chrg Select and Config_Non_Rem Select switches (SW5 and SW6).

FIGURE 2-3: STRAPPING OPTIONS

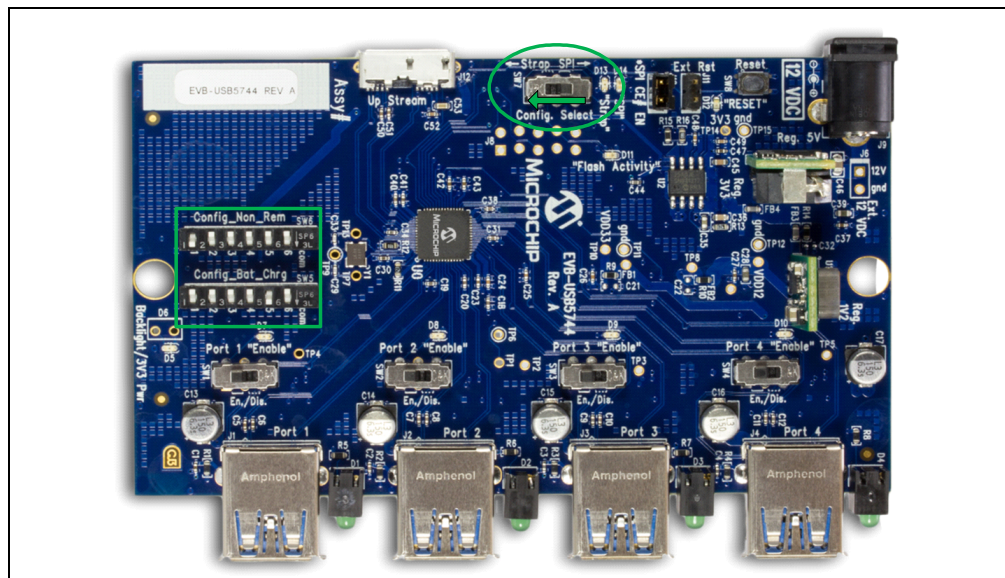

TABLE 2-1: STRAPPING OPTIONS FOR BATTERY CHARGING

SW5 Position	Configuration
1	No BC Enabled
2	Port 1 is BC Enabled
3	Port 1 & 2 are BC Enabled
4	Port 1, 2 & 3 are BC Enabled
5	Port 1, 2, 3 & 4 are BC Enabled [default]
6	Reserved

TABLE 2-2: STRAPPING OPTIONS FOR PORT REMOVABLE

SW6 Position	Configuration
1	All ports are Removable [default]
2	Port 1 is Non-Removable
3	Port 1 & 2 are Non-Removable
4	Port 1, 2 & 3 are Non-Removable
5	Port 1, 2, 3 & 4 are Non-Removable
6	Reserved

2.1.5 Port Power Options: Port Enable and Port Disable Select

Any downstream facing port on the EVB-USB5744 can be disabled if desired. When both **DP** & **DM** signals are pulled up to +3.3V, by default the USB5744 automatically disables the port, reports the corrected number of available ports to the host, and drives the PRT_CTRL line for the disabled port(s) low.

To enable a port, use its Port Enable switch to select the "EN." position. The associated "Enabled" LED will light.

To disable a port, slide its Port Enable switch to the "Dis." position. The "Enabled" LED will extinguish.

The table below describes the port enable/disable strap options available for all four ports on the USB5744.

TABLE 2-3: PORT ENABLE/DISABLE STRAP OPTIONS

Downstream Port	Associated Switch	Switch Position	LED
1	SW1	1-2, 4-5 = Port Enabled (Default)	
		2-3, 5-6 = Port Disabled	
2	SW2	1-2, 4-5 = Port Enabled (Default)	
		2-3, 5-6 = Port Disabled	
3	SW3	1-2, 4-5 = Port Enabled (Default)	
		2-3, 5-6 = Port Disabled	
4	SW4	1-2, 4-5 = Port Enabled (Default)	
		2-3, 5-6 = Port Disabled	

2.2 POWER SOURCE - SELF-POWERED

The EVB-USB5744 only supports self-powered operation, and is powered through one +12.0 V regulated 'wall wart' external power supply. The power supply plugs into the 2.5 mm connector J9 on the board. Alternatively, an external voltage can be injected onto the J6 Ext. 12 V header, which is not populated by default. The +12.0 V feeds a 6 A regulator which outputs +5.25 V across the board. This +5.25 V output supplies the +3.3 V and +1.2 V onboard regulators.

2.3 DOWNSTREAM PORT POWER CONTROL

USB power to the four downstream ports are controlled via port power controllers with auto-discharge function. This provides up to 2.1 A of USB battery charging power to each port, limited to a total of 5 A at any one time.

FIGURE 2-4: INITIAL CONFIGURATION

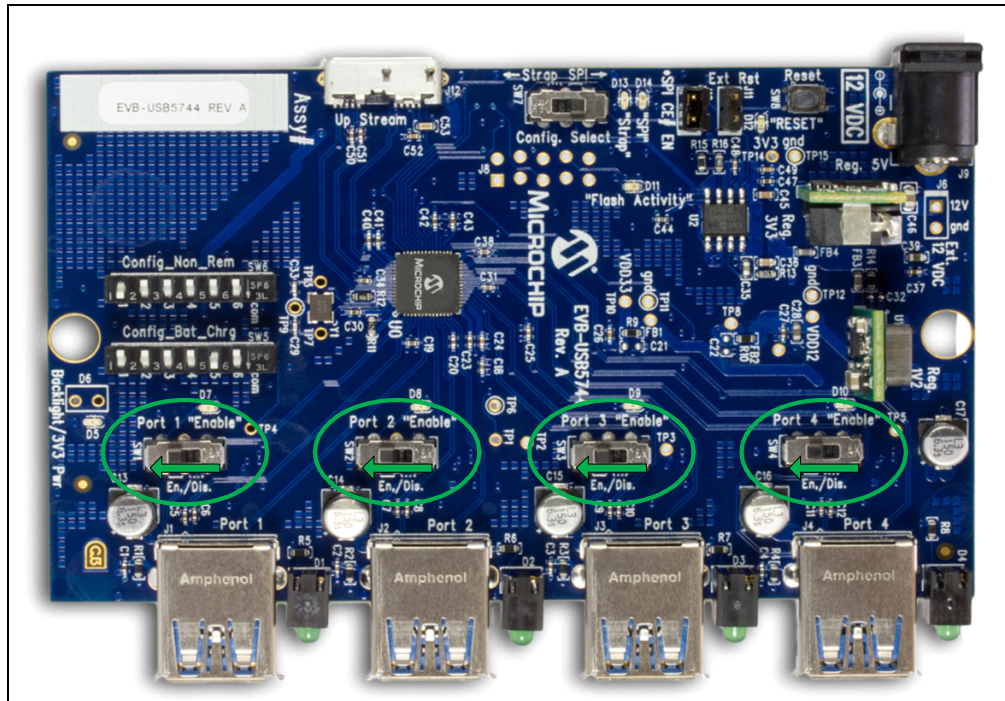

Appendix A. EVB-USB5744 Evaluation Board

A.1 INTRODUCTION

This appendix shows the EVB-USB5744 Evaluation Board.

FIGURE A-1: EVB-USB5744 EVALUATION BOARD

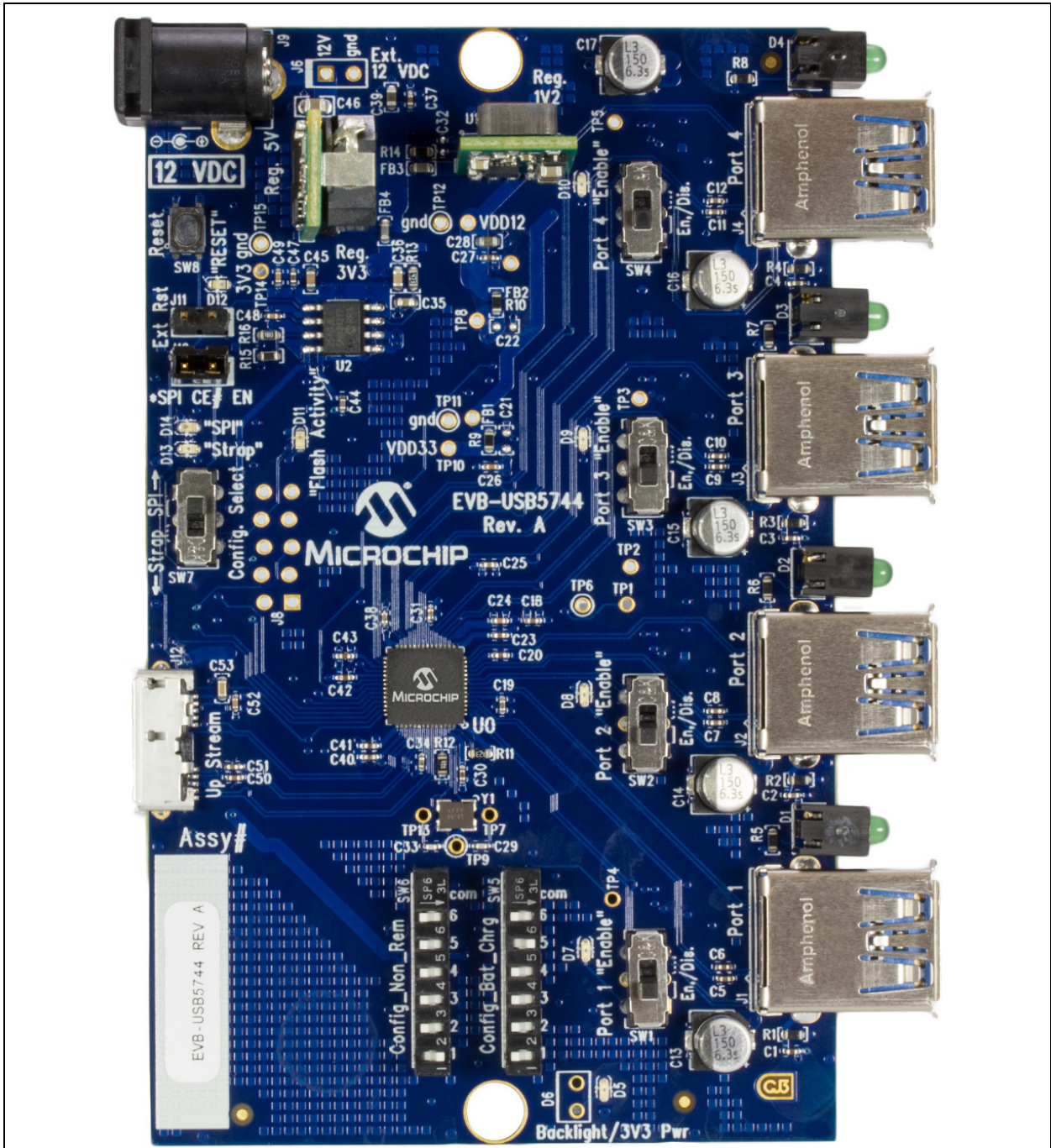



Appendix B. EVB-USB5744 Evaluation Board Schematics

B.1 INTRODUCTION

This appendix shows the EVB-USB5744 Evaluation Board Schematics.

FIGURE B-1: EVB-USB5744 EVALUATION BOARD SCHEMATIC 1

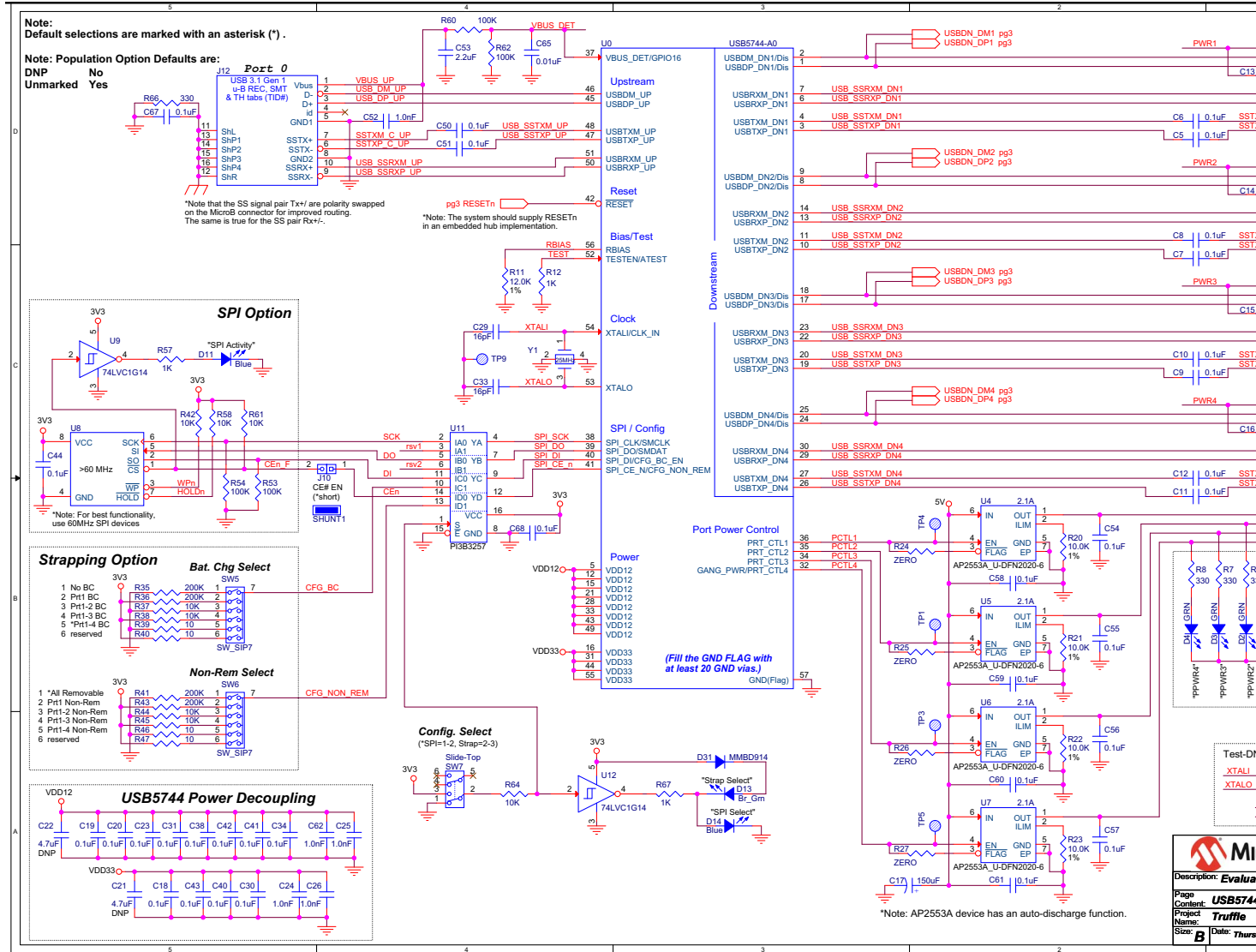
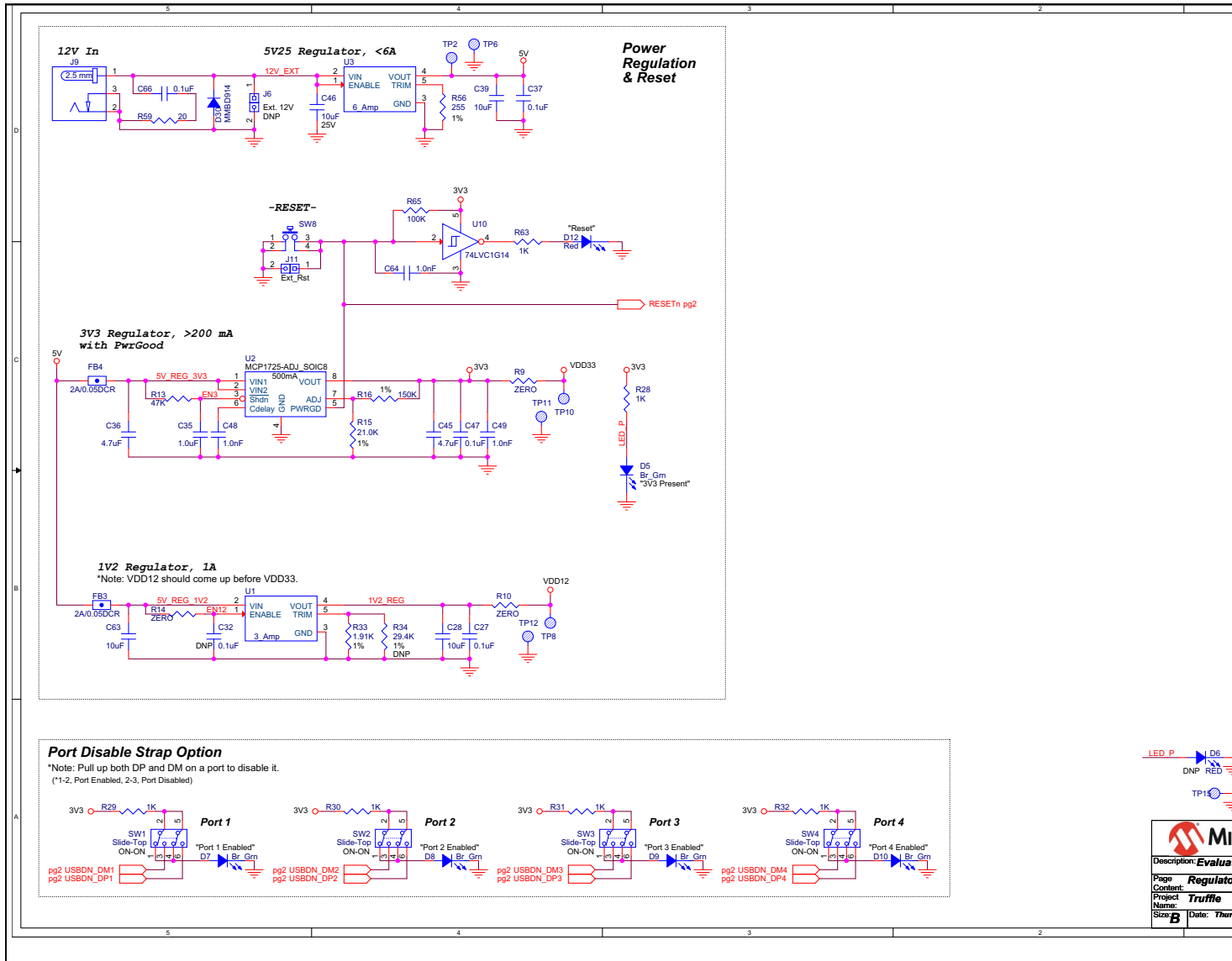

FIGURE B-2: EVB-USB5744 EVALUATION BOARD SCHEMATIC 2





Appendix C. Bill of Materials (BOM)

C.1 INTRODUCTION

This appendix includes the EVB-USB5744 Evaluation Board Bill of Materials (BOM).

TABLE C-1: EVB-USB5744 EVALUATION BOARD BILL OF MATERIALS

Item	Qty	Reference Designator(s)	Description	Manufacturer
1	41	C1,C2,C3,C4,C5,C6,C7,C8,C9,C10,C11,C12,C18,C19,C20,C23,C27,C30,C31,C34,C37,C38,C40,C41,C42,C43,C44,C47,C50,C51,C54,C55,C56,C57,C58,C59,C60,C61,C66,C67,C68	Capacitor, 0.1uF, 10%, 25V, X5R, 0402	Murata
2	5	C13,C14,C15,C16,C17	Capacitor, Low ESR, 150uF, 6.3VDC, 20%, Aluminum, Radial-SMT, 5mm x 5.7mm	Lelon
4	8	C24,C25,C26,C48,C49,C52,C62,C64	Capacitor, 1000pF, 50V, 10%, X7R, 0402	Murata
5	2	C28,C39	Capacitor, 10uF, 6.3VDC, 20%, X5R, 0603	Murata
6	2	C29,C33	Capacitor, 16pF, 50V, 2%, NPO, 0402	Murata
8	1	C35	Capacitor, 1.0uF, 16VDC, 10%, X5R, 0603	Murata
9	2	C36,C45	Capacitor, 4.7uF, 6.3VDC, 20%, X5R, 0603	Murata
10	2	C46,C63	Capacitor, 10uF, 25 VDC, 10%, 0805	Murata
11	1	C53	Capacitor, 2.2uF, 6.3VDC, 10%, X5R, 0603	Murata
12	1	C65	Capacitor, 0.01uF, 25V, 10%, X7R, 0402	Panasonic
13	4	D1,D2,D3,D4	LED, Green, 3mm, Diffused, 0.2" CL-vert, TH, Right Angle	Lumex
14	6	D5,D7,D8,D9,D10,D13	LED, Bright Green, 0603	Liteon
16	2	D11,D14	LED, Blue, 0603	Stanley Electric
17	1	D12	LED, Red, 0603	Stanley Electric
18	2	D30,D31	Diode, MMBD914LT, Fast Switching, 100VDC, 200mA, SOT-23	On Semiconductors
20	2	FB3,FB4	Ferrite Bead, 220 Ohm, 2A, 0.05DCR, 0603	Murata
21	9	R1,R2,R3,R4,R5,R6,R7,R8,R66	Resistor, 330, 5%, 1/16W, 0603	Panasonic
22	8	R9,R10,R14,R24,R25,R26,R27,R55	Resistor, ZERO, 0.1W, 0603	Panasonic
24	1	R11	Resistor, 12.0K, 1%, 1/16W, 0603	Panasonic
25	9	R12,R28,R29,R30,R31,R32,R57,R63,R67	Resistor, 1K, 5%, 1/16W, 0603	Panasonic
26	1	R13	Resistor, 47K, 5%, 1/16W, 0603	Yageo America
27	1	R15	Resistor, 21.0K, 1%, 1/10W, 0603	Panasonic
28	1	R16	Resistor, 150K, 1%, 1/16W, 0603	Panasonic
29	4	R20,R21,R22,R23	Resistor, 10.0K, 1%, 1/16W, 0603	Rohm
30	1	R33	Resistor, 1.91K, 1%, 1/10W, 0603	Stackpole Electronics
32	4	R35,R36,R41,R43	Resistor, 200K, 5%, 1/10W, 0603	Vishay/Dale
33	8	R37,R38,R42,R44,R45,R58,R61,R64	Resistor, 10K, 5%, 1/16W, 0603	Panasonic

TABLE C-1: EVB-USB5744 EVALUATION BOARD BILL OF MATERIALS (CONTINUED)

Item	Qty	Reference Designator(s)	Description	Manufacturer
34	4	R39,R40,R46,R47	Resistor, 10, 5%, 1/16W, 0603	Yageo America
35	5	R53,R54,R60,R62,R65	Resistor, 100K, 5%, 1/16W, 0603	Panasonic
36	1	R56	Resistor, 255, 1%, 1/10W, 0603	Panasonic
37	1	R59	Resistor, 20, 5%, 1/10W, 0603	Panasonic
39	2	J10,J11	Header, 1 x 2, 0.1 Inch, Vertical	FCI
41	1	J12	Receptacle, USB 3.1 Gen 1, Style MicroB, Right Angle, SMT, with TID#, TH Tabs	Hirose Electric Co Ltd
42	4	J1,J2,J3,J4	Receptacle, USB 3.1 Gen 1, Style A, Right Angle, Through-hole	Amphenol
43	1	J9	Connector, Power Jack, 2.5 mm x 5.5 mm, 12 V, 4 A, Right Angle, TH	Cui Stack
44	5	SW1,SW2,SW3,SW4,SW7	Switch, DPDT, Slide, Sub-Mini, Top Actuator, TH	C&K
45	2	SW5,SW6	Switch Array, SPST, 6 Position, SIP-7	CK
46	1	SW8	Switch, Momentary, SPST, 50mA, J-lead, NO, MicroMini	C&K Components
47	1	U0	IC, USB5744 USB 3.1 Gen 1 Hub, 4 port, QFN56	Microchip
48	1	U1	IC, DC-DC Converter Module, 0.591-6 Vout, ~12 Vin, 0.591-6 VDC out, 3A, 5 pin SIP, 0.41" Wide	Murata
49	1	U3	IC, DC-DC Converter Module, 0.591-6 Vout, ~12 Vin, 0.591-6 VDC out, 6A, 5 pin SIP, 0.41" Wide	Murata
50	1	U2	IC, MCP1725-ADJE/SN, LDO Regulator, Adj., 500 mA, SOIC8	Microchip
51	4	U4,U5,U6,U7	IC, AP2553AFDC-7, Power Distribution Switch, U-DFN2020-6	Diodes Inc.
52	1	U8	IC, Flash, SPI, SST25VF064C, 64Mb (8M x 8), 2.7V-3.3V, 75MHz (Dual Read), SO8	Microchip
53	3	U9,U10,U12	IC, 74LVC1G14, Inverter, Schottky, DCK	TI
54	1	U11	IC, PI3B3257, Quad 2:1 Mux, 3.3V, QSOP-16	Pericom
55	1	Y1	Crystal, 25.000MHz, 30ppm, 10pF, SMT 3.2MM X 2.5MM	Abrakon
56	2	SHUNT1	Shunt, Insulated, 0.1 Inch	TE Connectivity
57	4	-none	Foot, Silicone Rubber, Adhesive, Clear, Cylindrical, .500"x.250"	Bumper Specialties
58	1	LBL-SERNO	Label, Serial Number, Laminated, 250 x 800	Brother
59	1	LBL-ASSY1	Label, Assembly Number, Laminated, 250 x 800, "EVB-USB5744_A0"	Brother
60	1	PCB Fab	PCB, Truffle (EVB-USB5744), Rev. A	
61	1	Assembly	Assembly, Truffle (EVB-USB5744), Rev. A0	

Appendix D. EVB-USB5744 Silk Screens

D.1 INTRODUCTION

This appendix shows the EVB-USB5744 Top and Bottom Silk Screen images.

FIGURE D-1: EVB-USB5744 TOP SILK SCREEN

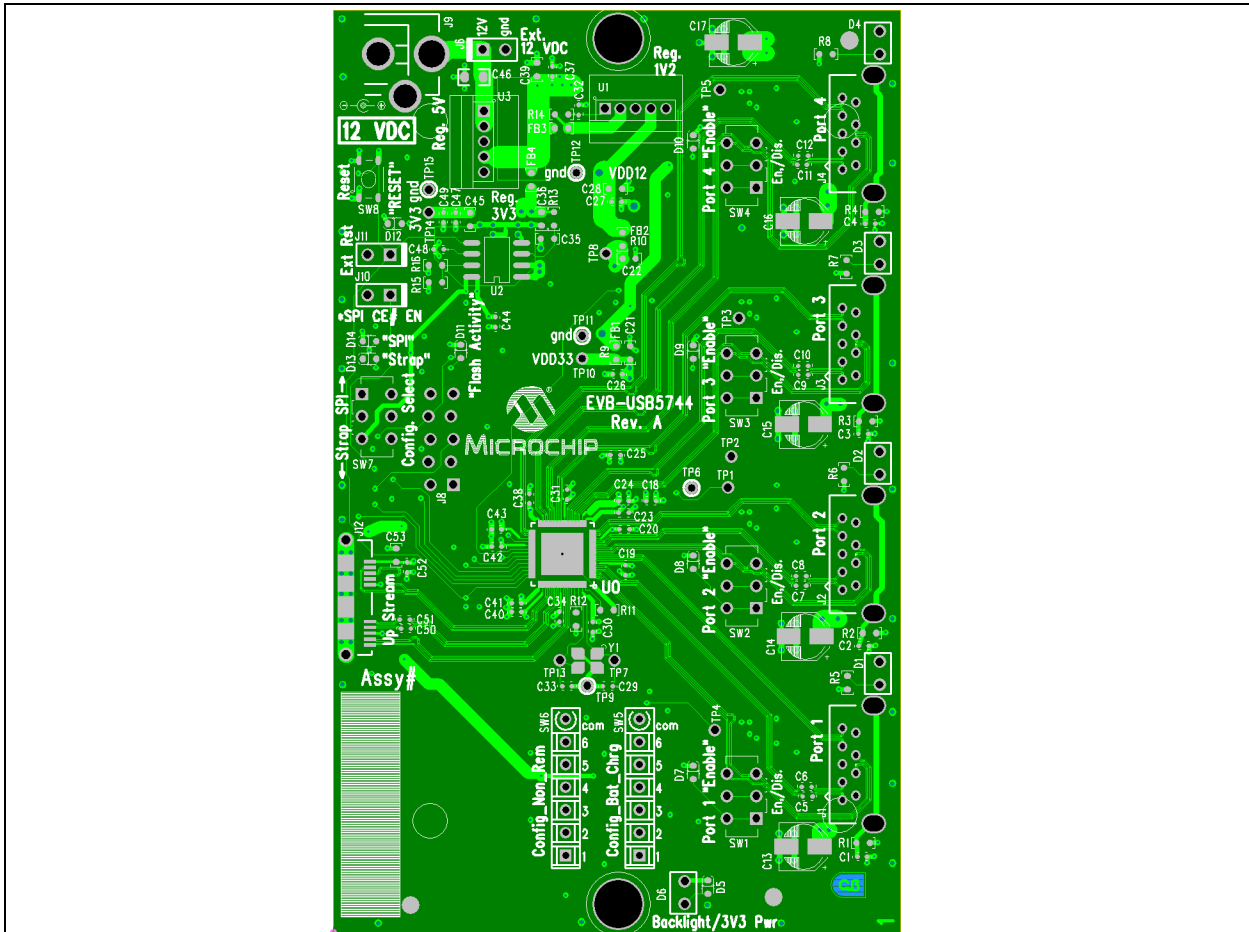
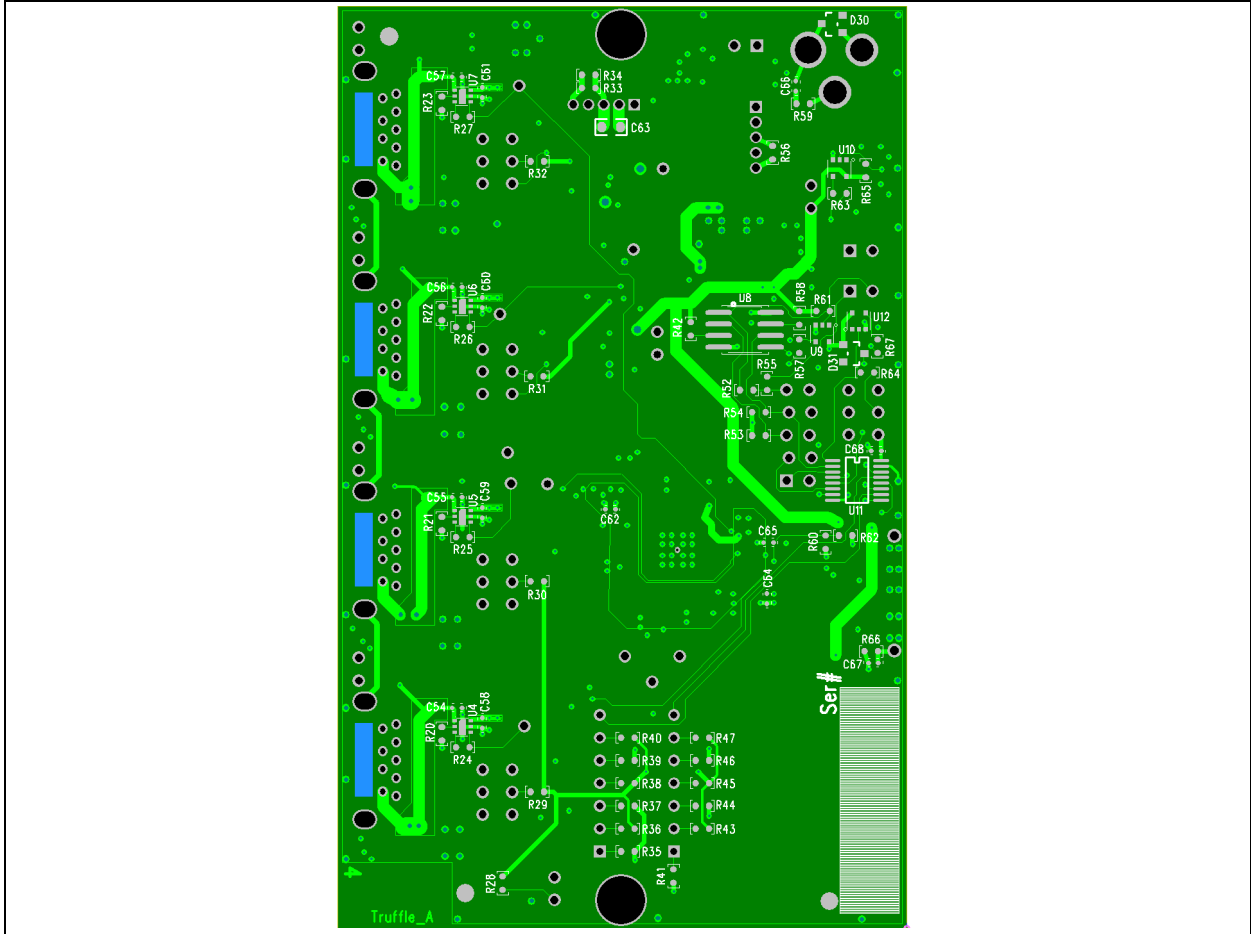

FIGURE D-2: EVB-USB5744 BOTTOM SILK SCREEN





MICROCHIP

Worldwide Sales and Service

AMERICAS

Corporate Office
2355 West Chandler Blvd.
Chandler, AZ 85224-6199
Tel: 480-792-7200
Fax: 480-792-7277
Technical Support:
<http://www.microchip.com/support>
Web Address:
www.microchip.com

Atlanta
Duluth, GA
Tel: 678-957-9614
Fax: 678-957-1455

Austin, TX
Tel: 512-257-3370

Boston
Westborough, MA
Tel: 774-760-0087
Fax: 774-760-0088

Chicago
Itasca, IL
Tel: 630-285-0071
Fax: 630-285-0075

Cleveland
Independence, OH
Tel: 216-447-0464
Fax: 216-447-0643

Dallas
Addison, TX
Tel: 972-818-7423
Fax: 972-818-2924

Detroit
Novi, MI
Tel: 248-848-4000

Houston, TX
Tel: 281-894-5983

Indianapolis
Noblesville, IN
Tel: 317-773-8323
Fax: 317-773-5453

Los Angeles
Mission Viejo, CA
Tel: 949-462-9523
Fax: 949-462-9608

New York, NY
Tel: 631-435-6000

San Jose, CA
Tel: 408-735-9110

Canada - Toronto
Tel: 905-673-0699
Fax: 905-673-6509

ASIA/PACIFIC

Asia Pacific Office
Suites 3707-14, 37th Floor
Tower 6, The Gateway
Harbour City, Kowloon

Hong Kong
Tel: 852-2943-5100
Fax: 852-2401-3431

Australia - Sydney
Tel: 61-2-9868-6733
Fax: 61-2-9868-6755

China - Beijing
Tel: 86-10-8569-7000
Fax: 86-10-8528-2104

China - Chengdu
Tel: 86-28-8665-5511
Fax: 86-28-8665-7889

China - Chongqing
Tel: 86-23-8980-9588
Fax: 86-23-8980-9500

China - Dongguan
Tel: 86-769-8702-9880

China - Hangzhou
Tel: 86-571-8792-8115
Fax: 86-571-8792-8116

China - Hong Kong SAR
Tel: 852-2943-5100
Fax: 852-2401-3431

China - Nanjing
Tel: 86-25-8473-2460
Fax: 86-25-8473-2470

China - Qingdao
Tel: 86-532-8502-7355
Fax: 86-532-8502-7205

China - Shanghai
Tel: 86-21-5407-5533
Fax: 86-21-5407-5066

China - Shenyang
Tel: 86-24-2334-2829
Fax: 86-24-2334-2393

China - Shenzhen
Tel: 86-755-8864-2200
Fax: 86-755-8203-1760

China - Wuhan
Tel: 86-27-5980-5300
Fax: 86-27-5980-5118

China - Xian
Tel: 86-29-8833-7252
Fax: 86-29-8833-7256

ASIA/PACIFIC

China - Xiamen
Tel: 86-592-2388138
Fax: 86-592-2388130

China - Zhuhai
Tel: 86-756-3210040
Fax: 86-756-3210049

India - Bangalore
Tel: 91-80-3090-4444
Fax: 91-80-3090-4123

India - New Delhi
Tel: 91-11-4160-8631
Fax: 91-11-4160-8632

India - Pune
Tel: 91-20-3019-1500

Japan - Osaka
Tel: 81-6-6152-7160
Fax: 81-6-6152-9310

Japan - Tokyo
Tel: 81-3-6880-3770
Fax: 81-3-6880-3771

Korea - Daegu
Tel: 82-53-744-4301
Fax: 82-53-744-4302

Korea - Seoul
Tel: 82-2-554-7200
Fax: 82-2-558-5932 or
82-2-558-5934

Malaysia - Kuala Lumpur
Tel: 60-3-6201-9857
Fax: 60-3-6201-9859

Malaysia - Penang
Tel: 60-4-227-8870
Fax: 60-4-227-4068

Philippines - Manila
Tel: 63-2-634-9065
Fax: 63-2-634-9069

Singapore
Tel: 65-6334-8870
Fax: 65-6334-8850

Taiwan - Hsin Chu
Tel: 886-3-5778-366
Fax: 886-3-5770-955

Taiwan - Kaohsiung
Tel: 886-7-213-7828

Taiwan - Taipei
Tel: 886-2-2508-8600
Fax: 886-2-2508-0102

Thailand - Bangkok
Tel: 66-2-694-1351
Fax: 66-2-694-1350

EUROPE

Austria - Wels
Tel: 43-7242-2244-39
Fax: 43-7242-2244-393

Denmark - Copenhagen
Tel: 45-4450-2828
Fax: 45-4485-2829

France - Paris
Tel: 33-1-69-53-63-20
Fax: 33-1-69-30-90-79

Germany - Dusseldorf
Tel: 49-2129-3766400

Germany - Karlsruhe
Tel: 49-721-625370

Germany - Munich
Tel: 49-89-627-144-0
Fax: 49-89-627-144-44

Italy - Milan
Tel: 39-0331-742611
Fax: 39-0331-466781

Italy - Venice
Tel: 39-049-7625286

Netherlands - Drunen
Tel: 31-416-690399
Fax: 31-416-690340

Poland - Warsaw
Tel: 48-22-3325737

Spain - Madrid
Tel: 34-91-708-08-90
Fax: 34-91-708-08-91

Sweden - Stockholm
Tel: 46-8-5090-4654

UK - Wokingham
Tel: 44-118-921-5800
Fax: 44-118-921-5820

07/14/15

X-ON Electronics

Largest Supplier of Electrical and Electronic Components

Click to view similar products for [Interface Development Tools](#) category:

Click to view products by [Microchip](#) manufacturer:

Other Similar products are found below :

[ADP5585CP-EVALZ](#) [CHA2066-99F](#) [AS8650-DB](#) [MLX80104 TESTINTERFACE](#) [416100120-3](#) [XR18910ILEVB](#) [XR21B1421IL28-0A-EVB](#) [TW-DONGLE-USB](#) [EVAL-ADM2491EEBZ](#) [MAXREFDES23DB#](#) [MAX13235EEVKIT](#) [DFR0257](#) [XR22404CG28EVB](#) [ZLR964122L](#) [ZLR88822L](#) [EVK-U23-01S](#) [EVK-W262U-00](#) [DC327A](#) [PIM511](#) [PIM536](#) [PIM517](#) [DEV-17512](#) [STR-FUSB3307MPX-PPS-GEVK](#) [MAXREFDES177#](#) [EVAL-ADM2567EEBZ](#) [ZSSC3240KIT](#) [MAX9121EVKIT](#) [PIM532](#) [ZSC31010KITV2P1](#) [UMFT4233HPEV](#) [LVDS-18B-EVK](#) [XR20M1170G16-0B-EB](#) [XR20M1170G24-0B-EB](#) [XR20M1172G28-0A-EB](#) [XR20M1172G28-0B-EB](#) [SI871XSOIC8-KIT](#) [1764](#) [1833](#) [1862](#) [EVB-USB82514](#) [ATA6628-EK](#) [ATA6631-EK](#) [EVAL-CN0313-SDPZ](#) [2264](#) [MCP23X17EV](#) [PS081-EVA-HR MODULE](#) [237](#) [SMA2RJ45EVK/NOPB](#) [FR12-0002](#) [MAFR-000455-001](#)