



MCP1525/41

2.5V and 4.096V Voltage References

Features

- Precision Voltage Reference
- Output Voltages: 2.5V and 4.096V
- Initial Accuracy: $\pm 1\%$ (max.)
- Temperature Drift: ± 50 ppm/ $^{\circ}\text{C}$ (max.)
- Output Current Drive: ± 2 mA
- Maximum Input Current: 100 μA @ +25 $^{\circ}\text{C}$ (max.)
- Packages: TO-92 and SOT-23-3
- Industrial Temperature Range: -40 $^{\circ}\text{C}$ to +85 $^{\circ}\text{C}$

Applications

- Battery-powered Systems
- Handheld Instruments
- Instrumentation and Process Control
- Test Equipment
- Data Acquisition Systems
- Communications Equipment
- Medical Equipment
- Precision Power supplies
- 8-bit, 10-bit, 12-bit A/D Converters (ADCs)
- D/A Converters (DACs)

Typical Application Circuit

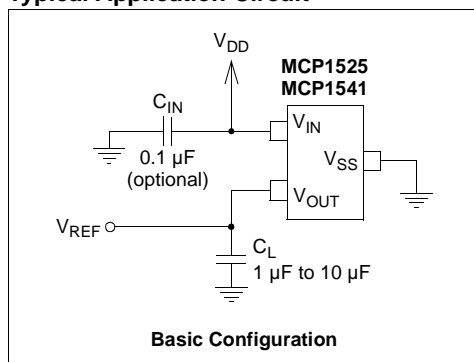

Description

The Microchip Technology Inc. MCP1525/41 devices are 2.5V and 4.096V precision voltage references that use a combination of an advanced CMOS circuit design and EPROM trimming to provide an initial tolerance of $\pm 1\%$ (max.) and temperature stability of ± 50 ppm/ $^{\circ}\text{C}$ (max.). In addition to a low quiescent current of 100 μA (max.) at 25 $^{\circ}\text{C}$, these devices offer a clear advantage over the traditional Zener techniques in terms of stability across time and temperature. The output voltage is 2.5V for the MCP1525 and 4.096V for the MCP1541. These devices are offered in SOT-23-3 and TO-92 packages, and are specified over the industrial temperature range of -40 $^{\circ}\text{C}$ to +85 $^{\circ}\text{C}$.

Temperature Drift

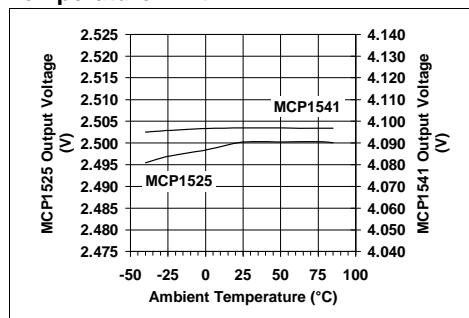

Package Types

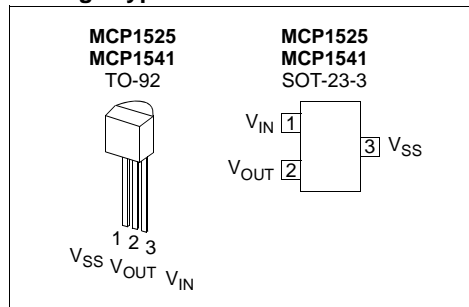

MCP1525/41

1.0 ELECTRICAL CHARACTERISTICS

Absolute Maximum Ratings †

$V_{IN} - V_{SS}$	7.0V
Input Current (V_{IN})	20 mA
Output Current (V_{OUT})	±20 mA
Continuous Power Dissipation ($T_A = 125^\circ\text{C}$).....	140 mW
All Inputs and Outputs	$V_{SS} - 0.6\text{V}$ to $V_{IN} + 1.0\text{V}$
Storage Temperature.....	-65°C to $+150^\circ\text{C}$
Maximum Junction Temperature (T_J).....	$+125^\circ\text{C}$
ESD protection on all pins (HBM).....	≥ 4 kV

† **Notice:** Stresses above those listed under “Absolute Maximum Ratings” may cause permanent damage to the device. This is a stress rating only and functional operation of the device at those or any other conditions above those indicated in the operational listings of this specification is not implied. Exposure to maximum rating conditions for extended periods may affect device reliability.

DC ELECTRICAL SPECIFICATIONS

Electrical Characteristics: Unless otherwise indicated, $T_A = +25^\circ\text{C}$, $V_{IN} = 5.0\text{V}$, $V_{SS} = \text{GND}$, $I_{OUT} = 0\text{ mA}$ and $C_L = 1\ \mu\text{F}$.						
Parameter	Sym	Min	Typ	Max	Units	Conditions
Output						
Output Voltage, MCP1525	V_{OUT}	2.475	2.5	2.525	V	$2.7\text{V} \leq V_{IN} \leq 5.5\text{V}$
Output Voltage, MCP1541	V_{OUT}	4.055	4.096	4.137	V	$4.3\text{V} \leq V_{IN} \leq 5.5\text{V}$
Output Voltage Drift	TCV_{OUT}	—	27	50	ppm/ $^\circ\text{C}$	$T_A = -40^\circ\text{C}$ to 85°C (Note 1)
Long-Term Output Stability	V_{OUT}	—	2	—	ppm/hr	Exposed 1008 hrs @ $+125^\circ\text{C}$ (see Figure 1-1), measured @ $+25^\circ\text{C}$
Load Regulation	$\Delta V_{OUT}/\Delta I_{OUT}$	—	0.5	1	mV/mA	$I_{OUT} = 0\text{ mA}$ to -2 mA
	$\Delta V_{OUT}/\Delta I_{OUT}$	—	0.6	1	mV/mA	$I_{OUT} = 0\text{ mA}$ to 2 mA
	$\Delta V_{OUT}/\Delta I_{OUT}$	—	—	1.3	mV/mA	$I_{OUT} = 0\text{ mA}$ to -2 mA , $T_A = -40^\circ\text{C}$ to 85°C
	$\Delta V_{OUT}/\Delta I_{OUT}$	—	—	1.3	mV/mA	$I_{OUT} = 0\text{ mA}$ to 2 mA , $T_A = -40^\circ\text{C}$ to 85°C
Output Voltage Hysteresis	V_{HYS}	—	115	—	ppm	Note 2
Maximum Load Current	I_{SC}	—	±8	—	mA	$T_A = -40^\circ\text{C}$ to 85°C , $V_{IN} = 5.5\text{V}$
Input-to-Output						
Dropout Voltage	V_{DROP}	—	137	—	mV	$I_{OUT} = 2\text{ mA}$
Line Regulation	$\Delta V_{OUT}/\Delta V_{IN}$	—	107	300	$\mu\text{V}/\text{V}$	$V_{IN} = 2.7\text{V}$ to 5.5V for MCP1525, $V_{IN} = 4.3\text{V}$ to 5.5V for MCP1541
	$\Delta V_{OUT}/\Delta V_{IN}$	—	—	350	$\mu\text{V}/\text{V}$	$V_{IN} = 2.7\text{V}$ to 5.5V for MCP1525, $V_{IN} = 4.3\text{V}$ to 5.5V for MCP1541, $T_A = -40^\circ\text{C}$ to 85°C
Input						
Input Voltage, MCP1525	V_{IN}	2.7	—	5.5	V	$T_A = -40^\circ\text{C}$ to 85°C
Input Voltage, MCP1541	V_{IN}	4.3	—	5.5	V	$T_A = -40^\circ\text{C}$ to 85°C
Input Current	I_{IN}	—	86	100	μA	No load
	I_{IN}	—	95	120	μA	No load, $T_A = -40^\circ\text{C}$ to 85°C

Note 1: Output temperature coefficient is measured using a “box” method, where the $+25^\circ\text{C}$ output voltage is trimmed as close to typical as possible. The 85°C output voltage is then again trimmed to zero out the tempco.

Note 2: Output Voltage Hysteresis is defined as the change in output voltage measured at $+25^\circ\text{C}$ before and after cycling the temperature to $+85^\circ\text{C}$ and -40°C ; refer to **Section 1.1.10 “Output Voltage Hysteresis”**.

MCP1525/41

AC ELECTRICAL SPECIFICATIONS

Electrical Characteristics: Unless otherwise indicated, $T_A = +25^\circ\text{C}$, $V_{IN} = 5.0\text{V}$, $V_{SS} = \text{GND}$, $I_{OUT} = 0\text{ mA}$ and $C_L = 1\ \mu\text{F}$.						
Parameter	Sym	Min	Typ	Max	Units	Conditions
AC Response						
Bandwidth	BW	—	100	—	kHz	
Input and Load Capacitors (see Figure 4-1)						
Input Capacitor	C_{IN}	—	0.1	—	μF	Notes 1
Load Capacitor	C_L	1	—	10	μF	Notes 2
Noise						
MCP1525 Output Noise Voltage	E_{no}	—	90	—	μV_{P-P}	0.1 Hz to 10 Hz
	E_{no}	—	500	—	μV_{P-P}	10 Hz to 10 kHz
MCP1541 Output Noise Voltage	E_{no}	—	145	—	μV_{P-P}	0.1 Hz to 10 Hz
	E_{no}	—	700	—	μV_{P-P}	10 Hz to 10 kHz

Note 1: The input capacitor is optional; Microchip recommends using a ceramic capacitor.

Note 2: These parts are tested at both 1 μF and 10 μF to ensure proper operation over this range of load capacitors. A wider range of load capacitor values has been characterized successfully, but is not tested in production.

TEMPERATURE SPECIFICATIONS

Electrical Characteristics: Unless otherwise indicated, $T_A = +25^\circ\text{C}$, $V_{IN} = 5.0\text{V}$ and $V_{SS} = \text{GND}$.						
Parameter	Sym	Min	Typ	Max	Units	Conditions
Temperature Ranges						
Specified Temperature Range	T_A	-40	—	+85	$^\circ\text{C}$	
Operating Temperature Range	T_A	-40	—	+125	$^\circ\text{C}$	Note 1
Storage Temperature Range	T_A	-65	—	+150	$^\circ\text{C}$	
Thermal Package Resistances						
Thermal Resistance, TO-92	θ_{JA}	—	132	—	$^\circ\text{C/W}$	
Thermal Resistance, SOT-23-3	θ_{JA}	—	336	—	$^\circ\text{C/W}$	

Note 1: These voltage references operate over the Operating Temperature Range, but with reduced performance. In any case, the internal Junction Temperature (T_J) must not exceed the Absolute Maximum specification of $+150^\circ\text{C}$.

1.1 Specification Descriptions and Test Circuits

1.1.1 OUTPUT VOLTAGE

Output voltage is the reference voltage that is available on the output pin (V_{OUT}).

1.1.2 INPUT VOLTAGE

The input (operating) voltage is the range of voltage that can be applied to the V_{IN} pin and still have the device produce the designated output voltage on the V_{OUT} pin.

1.1.3 OUTPUT VOLTAGE DRIFT (TCV_{OUT})

The output temperature coefficient or voltage drift is a measure of how much the output voltage (V_{OUT}) will vary from its initial value with changes in ambient temperature. The value specified in the electrical specifications is measured and equal to:

EQUATION 1-1:

$$TCV_{OUT} = \frac{\Delta V_{OUT}/V_{NOM}}{\Delta T_A} \quad (\text{ppm}/^\circ\text{C})$$

Where:

$$V_{NOM} = 2.5\text{V}, \text{MCP1525}$$

$$V_{NOM} = 4.096\text{V}, \text{MCP1541}$$

MCP1525/41

1.1.4 DROPOUT VOLTAGE

The dropout voltage of these devices is measured by reducing V_{IN} to the point where the output drops by 1%. Under these conditions the dropout voltage is equal to:

EQUATION 1-2:

$$V_{DROP} = V_{IN} - V_{OUT}$$

The dropout voltage is affected by ambient temperature and load current.

In Figure 2-18, the dropout voltage is shown over a negative and positive range of output current. For currents above zero milliamps, the dropout voltage is positive. In this case, the voltage reference is primarily powered by V_{IN} . With output currents below zero milliamps, the dropout voltage is negative. As the output current becomes more negative, the input current (I_{IN}) reduces. Under this condition, the output current begins to provide the needed power to the voltage reference.

1.1.5 LINE REGULATION

Line regulation is a measure of the change in output voltage (V_{OUT}) as a function of a change in the input voltage (V_{IN}). This is expressed as $\Delta V_{OUT}/\Delta V_{IN}$ and is measured in either $\mu V/V$ or ppm. For example, a 1 μV change in V_{OUT} caused by a 500 mV change in V_{IN} would net a $\Delta V_{OUT}/\Delta V_{IN}$ of 2 $\mu V/V$, or 2 ppm.

1.1.6 LOAD REGULATION ($\Delta V_{OUT}/\Delta I_{OUT}$)

Load regulation is a measure of the change in the output voltage (V_{OUT}) as a function of the change in output current (I_{OUT}). Load regulation is usually measured in mV/mA.

1.1.7 INPUT CURRENT

The input current (operating current) is the current that sinks from V_{IN} to V_{SS} without a load current on the output pin. This current is affected by temperature and the output current.

1.1.8 INPUT VOLTAGE REJECTION RATIO

The Input Voltage Rejection Ratio (IVRR) is a measure of the change in output voltage versus the change in input voltage over frequency, as shown in Figure 2-7. The calculation used for this plot is:

EQUATION 1-3:

$$IVRR = 20 \log \left| \frac{V_{IN}}{V_{OUT}} \right| \text{ (dB)}$$

1.1.9 LONG-TERM OUTPUT STABILITY

The long-term output stability is measured by exposing the devices to an ambient temperature of 125°C (Figure 2-9) while configured in the circuit shown in Figure 1-1. In this test, all electrical specifications of the devices are measured periodically at +25°C.

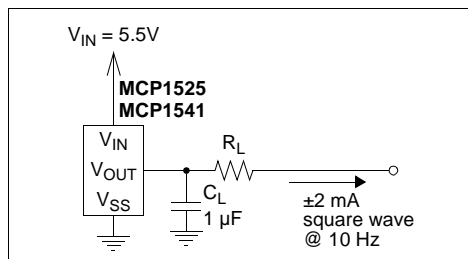

FIGURE 1-1: Dynamic Life Test Configuration.

1.1.10 OUTPUT VOLTAGE HYSTERESIS

The output voltage hysteresis is a measure of the output voltage error once the powered devices are cycled over the entire operating temperature range. The amount of hysteresis can be quantified by measuring the change in the +25°C output voltage after temperature excursions from +25°C to +85°C to +25°C and also from +25°C to -40°C to +25°C.

MCP1525/41

2.0 TYPICAL PERFORMANCE CURVES

Note: The graphs and tables provided following this note are a statistical summary based on a limited number of samples and are provided for informational purposes only. The performance characteristics listed herein are not tested or guaranteed. In some graphs or tables, the data presented may be outside the specified operating range (e.g., outside specified power supply range) and therefore outside the warranted range.

Note: Unless otherwise indicated, $T_A = +25^\circ\text{C}$, $V_{IN} = 5.0\text{V}$, $V_{SS} = \text{GND}$, $I_{OUT} = 0\text{ mA}$ and $C_L = 1\ \mu\text{F}$.

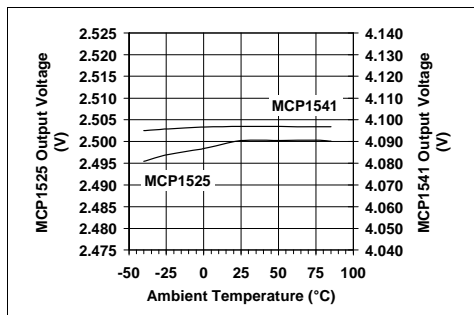

FIGURE 2-1: Output Voltage vs. Ambient Temperature.

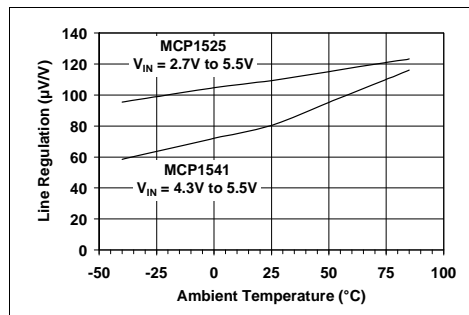

FIGURE 2-4: Line Regulation vs. Ambient Temperature.

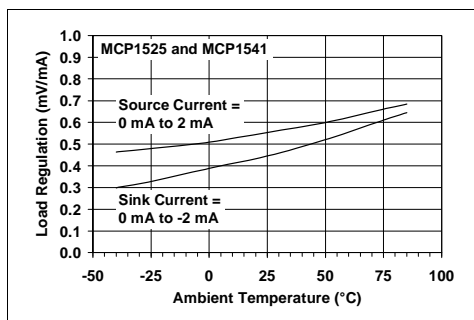

FIGURE 2-2: Load Regulation vs. Ambient Temperature.

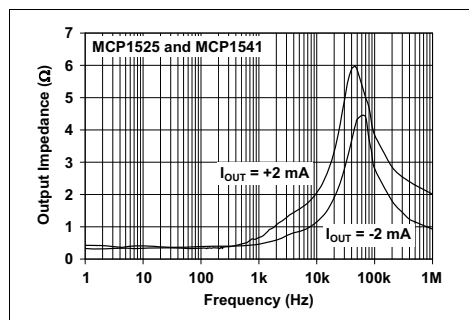

FIGURE 2-5: Output Impedance vs. Frequency.

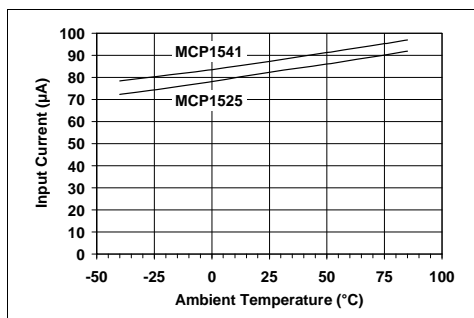

FIGURE 2-3: Input Current vs. Ambient Temperature.

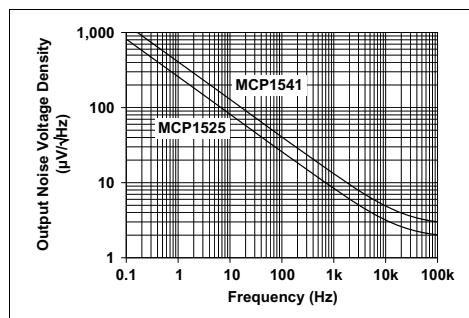

FIGURE 2-6: Output Noise Voltage Density vs. Frequency.

MCP1525/41

Note: Unless otherwise indicated, $T_A = +25^\circ\text{C}$, $V_{IN} = 5.0\text{V}$, $V_{SS} = \text{GND}$, $I_{OUT} = 0\text{ mA}$ and $C_L = 1\ \mu\text{F}$.

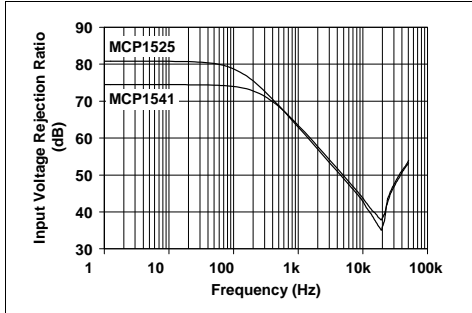

FIGURE 2-7: Input Voltage Rejection Ratio vs. Frequency.

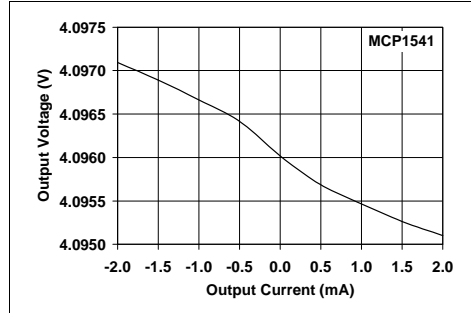

FIGURE 2-10: MCP1541 Output Voltage vs. Output Current.

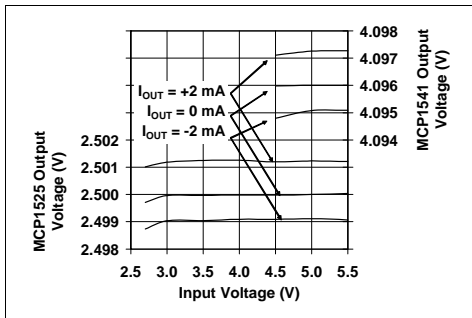

FIGURE 2-8: Output Voltage vs. Input Voltage.

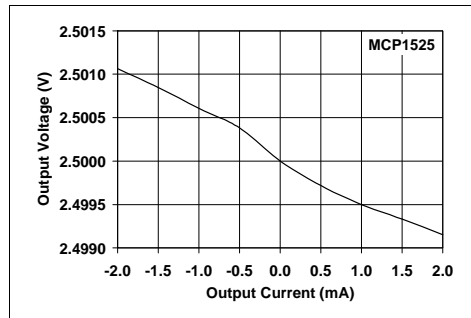

FIGURE 2-11: MCP1525 Output Voltage vs. Output Current.

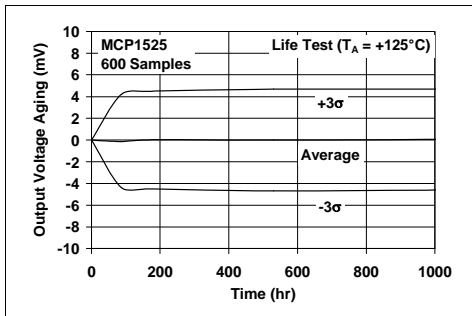

FIGURE 2-9: Output Voltage Aging vs. Time (MCP1525 Device Life Test data).

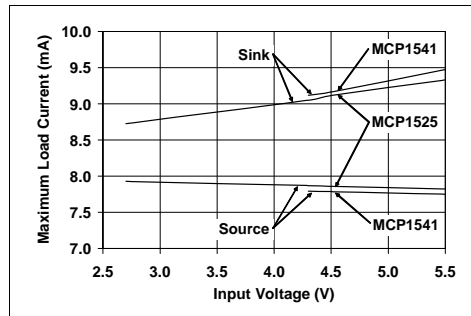

FIGURE 2-12: Maximum Load Current vs. Input Voltage.

MCP1525/41

Note: Unless otherwise indicated, $T_A = +25^\circ\text{C}$, $V_{IN} = 5.0\text{V}$, $V_{SS} = \text{GND}$, $I_{OUT} = 0\text{ mA}$ and $C_L = 1\text{ }\mu\text{F}$.

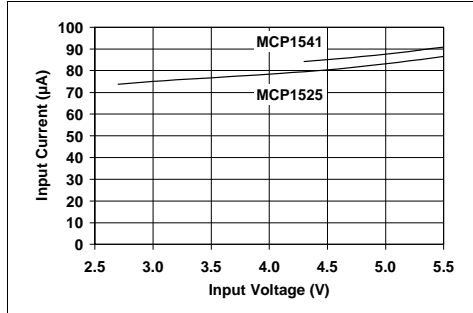

FIGURE 2-13: Input Current vs. Input Voltage.

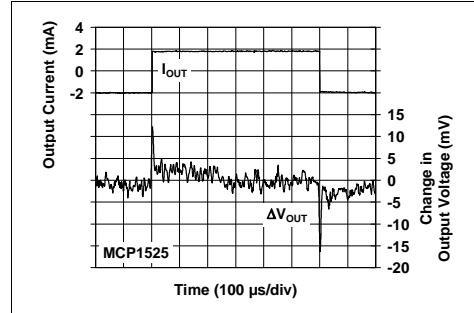

FIGURE 2-16: MCP1525 Load Transient Response.

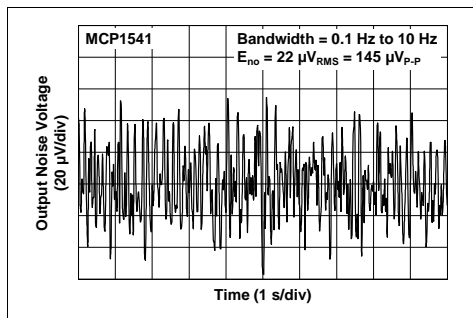

FIGURE 2-14: MCP1541 0.1 Hz to 10 Hz Output Noise.

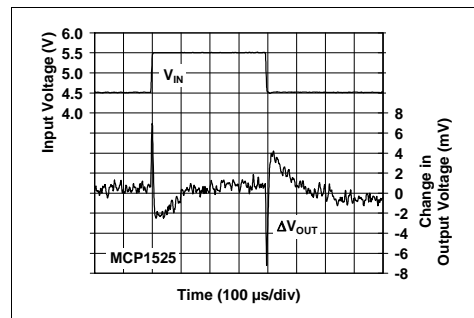

FIGURE 2-17: MCP1525 Line Transient Response.

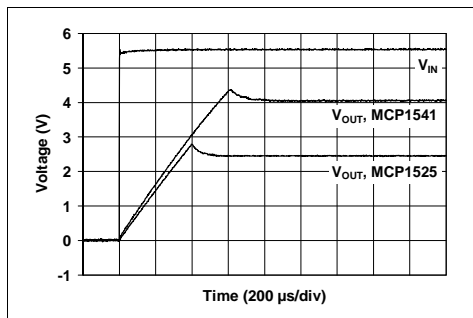

FIGURE 2-15: Turn-on Transient Time.

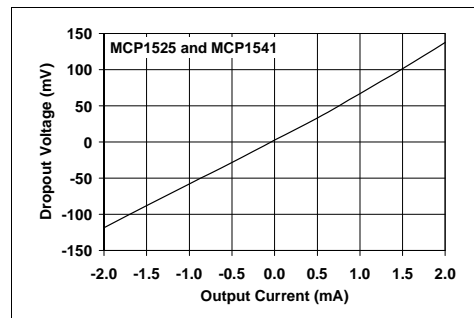

FIGURE 2-18: Dropout Voltage vs. Output Current.

MCP1525/41

3.0 PIN DESCRIPTIONS

Descriptions of the pins are listed in Table 3-1.

TABLE 3-1: PIN FUNCTION TABLE.

MCP1525, MCP1541 (TO-92-3)	MCP1525, MCP1541 (SOT-23-3)	Symbol	Description
3	1	V_{IN}	Input Voltage (or Positive Power Supply)
2	2	V_{OUT}	Output Voltage (or Reference Voltage)
1	3	V_{SS}	Ground (or Negative Power Supply)

3.1 Input Voltage (V_{IN})

V_{IN} functions as the positive power supply input (or operating input). An optional 0.1 μF ceramic capacitor can be placed at this pin if the input voltage is too noisy; it needs to be within 5 mm of this pin. The input voltage needs to be at least 0.2V higher than the output voltage for normal operation.

3.2 Output Voltage (V_{OUT})

V_{OUT} is an accurate reference voltage output. It can source and sink small currents, and has a low output impedance. A load capacitor between 1 μF and 10 μF needs to be located within 5 mm of this pin.

3.3 Ground (V_{SS})

Normally connected directly to ground. It can be placed at another voltage as long as all of the voltages shift with it, and proper bypassing is observed.

MCP1525/41

4.0 APPLICATIONS INFORMATION

4.1 Application Tips

4.1.1 BASIC CIRCUIT CONFIGURATION

The MCP1525 and MCP1541 voltage reference devices should be applied as shown in Figure 4-1 in all applications.

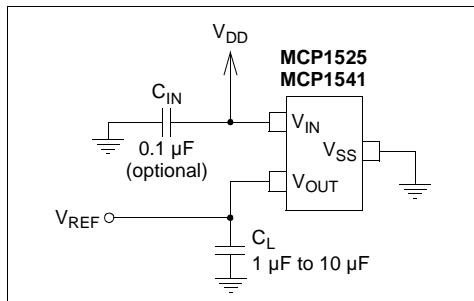

FIGURE 4-1: Basic Circuit Configuration.

As shown in Figure 4-1, the input voltage is connected to the device at the V_{IN} input, with an optional 0.1 μF ceramic capacitor. This capacitor would be required if the input voltage has excess noise. A 0.1 μF capacitor would reject input voltage noise at approximately 1 to 2 MHz. Noise below this frequency will be amply rejected by the input voltage rejection of the voltage reference. Noise at frequencies above 2 MHz will be beyond the bandwidth of the voltage reference and, consequently, not transmitted from the input pin through the device to the output.

The load capacitance (C_L) is required in order to stabilize the voltage reference; see **Section 4.1.3 "Load Capacitor"**.

4.1.2 INPUT (BYPASS) CAPACITOR

The MCP1525 and MCP1541 voltage references do not require an input capacitor across V_{IN} to V_{SS} . However, for added stability and input voltage transient noise reduction, a 0.1 μF ceramic capacitor is recommended, as shown in Figure 4-1. This capacitor should be close to the device (within 5 mm of the pin).

4.1.3 LOAD CAPACITOR

The output capacitor from V_{OUT} to V_{SS} acts as a frequency compensation for the references and cannot be omitted. Use load capacitors between 1 μF and 10 μF to compensate these devices. A 10 μF output capacitor has slightly better noise, and provides additional charge for fast load transients, when compared to a 1 μF output capacitor. This capacitor should be close to the device (within 5 mm of the pin).

4.1.4 PRINTED CIRCUIT BOARD LAYOUT CONSIDERATIONS

Mechanical stress due to Printed Circuit Board (PCB) mounting can cause the output voltage to shift from its initial value. Devices in the SOT-23-3 package are generally more prone to assembly stress than devices in the TO-92 package. To reduce stress-related output voltage shifts, mount the reference on low-stress areas of the PCB (i.e., away from PCB edges, screw holes and large components).

4.1.5 OUTPUT FILTERING

If the noise at the output of these voltage references is too high for the particular application, it can be easily filtered with an external RC filter and op amp buffer. The op amp's input and output voltage ranges need to include the reference output voltage.

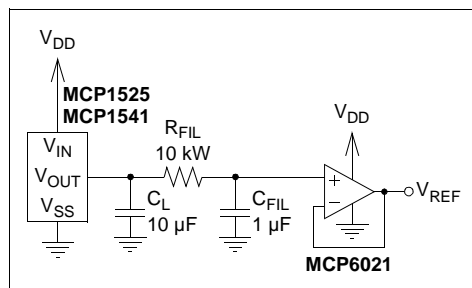

FIGURE 4-2: Output Noise-Reducing Filter.

The RC filter values are selected for a desired cutoff frequency:

EQUATION 4-1:

$$f_c = \frac{1}{2\pi R_{FIL} C_{FIL}}$$

The values that are shown in Figure 4-2 (10 k Ω and 1 μF) will create a first-order, low-pass filter at the output of the amplifier. The cutoff frequency of this filter is 15.9 Hz, and the attenuation slope is 20 dB/decade. The MCP6021 amplifier isolates the loading of this low-pass filter from the remainder of the application circuit. This amplifier also provides additional drive, with a faster response time than the voltage reference.

MCP1525/41

4.2 Typical Application Circuits

4.2.1 NEGATIVE VOLTAGE REFERENCE

A negative precision voltage reference can be generated by using the MCP1525 or MCP1541 in the configuration shown in Figure 4-3.

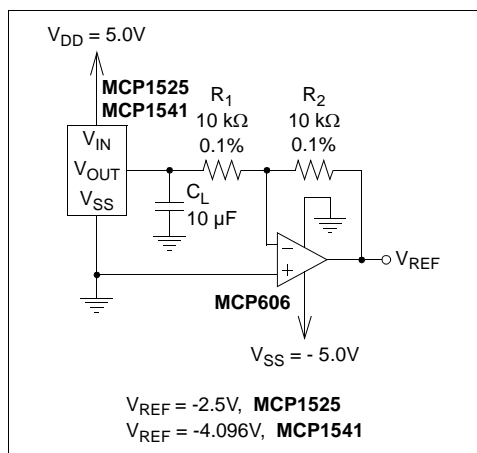

FIGURE 4-3: Negative Voltage Reference.

In this circuit, the voltage inversion is implemented using the MCP606 and two equal resistors. The voltage at the output of the MCP1525 or MCP1541 voltage reference drives R_1 , which is connected to the inverting input of the MCP606 amplifier. Since the non-inverting input of the amplifier is biased to ground, the inverting input will also be close to ground potential. The second 10 k Ω resistor is placed around the feedback loop of the amplifier. Since the inverting input of the amplifier is high-impedance, the current generated through R_1 will also flow through R_2 . As a consequence, the output voltage of the amplifier is equal to -2.5V for the MCP1525 and -4.1V for the MCP1541.

4.2.2 A/D CONVERTER REFERENCE

The MCP1525 and MCP1541 were carefully designed to provide a voltage reference for Microchip's 10-bit and 12-bit families of ADCs. The circuit shown in Figure 4-4 shows a MCP1541 configured to provide the reference to the MCP3201, a 12-bit ADC.

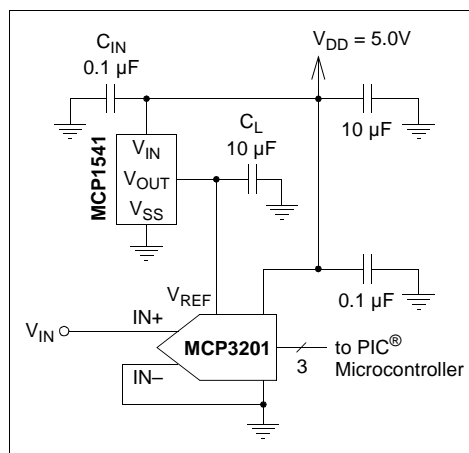

FIGURE 4-4: ADC Reference Circuit.

MCP1525/41

5.0 PACKAGING INFORMATION

5.1 Package Marking Information

3-Lead TO-92 (Leaded)

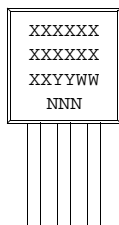

Example:

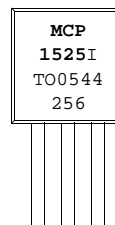

3-Lead TO-92 (Lead Free)

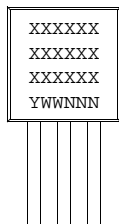

Example:

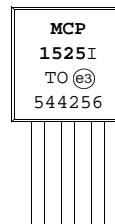

3-Lead SOT-23-3

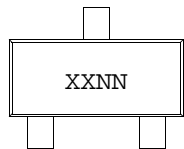

Device	I-Temp Code
MCP1525	VANN
MCP1541	VBNN

Note: Applies to 3-Lead SOT-23.

Example:

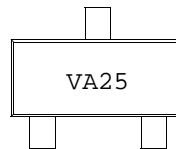

Legend: XX...X Customer-specific information
 Y Year code (last digit of calendar year)
 YY Year code (last 2 digits of calendar year)
 WW Week code (week of January 1 is week '01')
 NNN Alphanumeric traceability code
 (e3) Pb-free JEDEC designator for Matte Tin (Sn)
 * This package is Pb-free. The Pb-free JEDEC designator (e3) can be found on the outer packaging for this package.

Note: In the event the full Microchip part number cannot be marked on one line, it will be carried over to the next line, thus limiting the number of available characters for customer-specific information.

MCP1525/41

3-Lead Plastic Transistor Outline (TO) (TO-92)

Note: For the most current package drawings, please see the Microchip Packaging Specification located at <http://www.microchip.com/packaging>

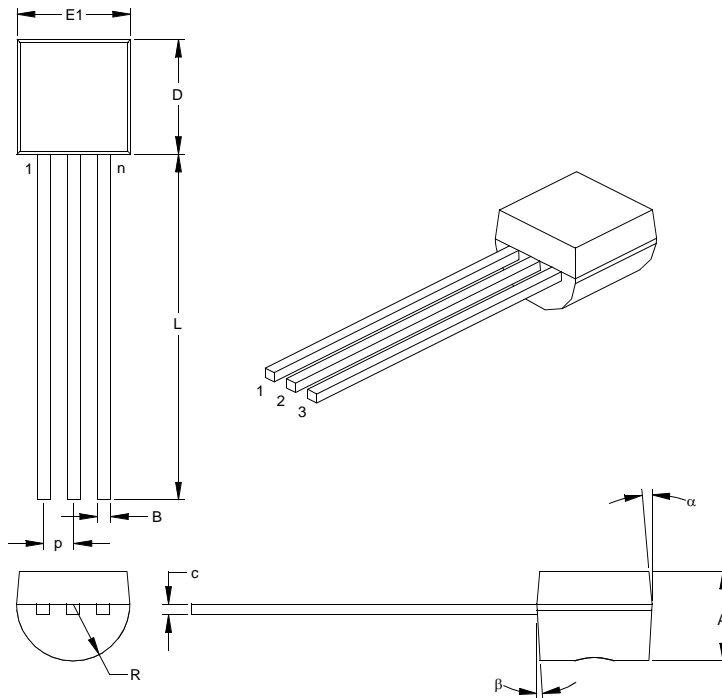

Dimension Limits	Units	INCHES*			MILLIMETERS		
		MIN	NOM	MAX	MIN	NOM	MAX
Number of Pins	n		3			3	
Pitch	p		.050			1.27	
Bottom to Package Flat	A	.130	.143	.155	3.30	3.62	3.94
Overall Width	E1	.175	.186	.195	4.45	4.71	4.95
Overall Length	D	.170	.183	.195	4.32	4.64	4.95
Molded Package Radius	R	.085	.090	.095	2.16	2.29	2.41
Tip to Seating Plane	L	.500	.555	.610	12.70	14.10	15.49
Lead Thickness	c	.014	.017	.020	0.36	0.43	0.51
Lead Width	B	.016	.019	.022	0.41	0.48	0.56
Mold Draft Angle Top	α	4	5	6	4	5	6
Mold Draft Angle Bottom	β	2	3	4	2	3	4

*Controlling Parameter

Notes:

Dimensions D and E1 do not include mold flash or protrusions. Mold flash or protrusions shall not exceed .010" (0.254mm) per side.

JEDEC Equivalent: TO-92

Drawing No. C04-101

MCP1525/41

3-Lead Plastic Small Outline Transistor (TT) (SOT23)

Note: For the most current package drawings, please see the Microchip Packaging Specification located at <http://www.microchip.com/packaging>

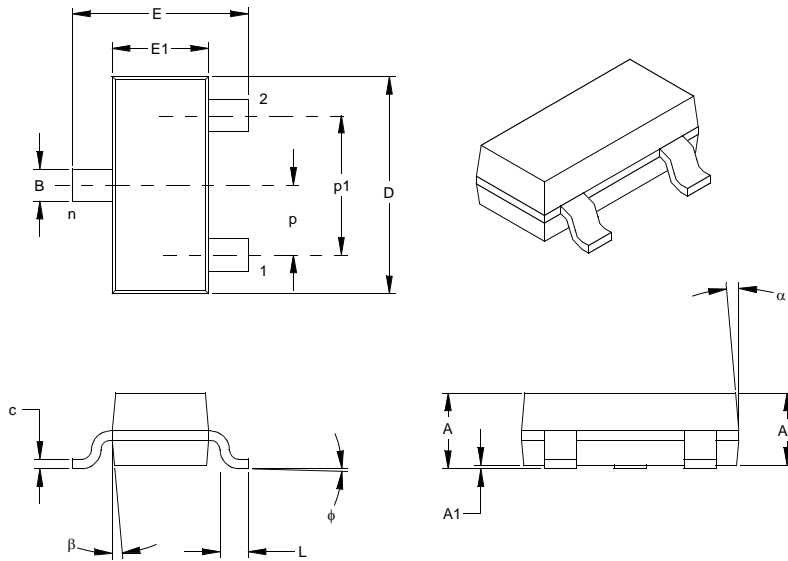

Dimension Limits	Units	INCHES*			MILLIMETERS		
		MIN	NOM	MAX	MIN	NOM	MAX
Number of Pins	n		3			3	
Pitch	p		.038			0.96	
Outside lead pitch (basic)	p1		.076			1.92	
Overall Height	A	.035	.040	.044	0.89	1.01	1.12
Molded Package Thickness	A2	.035	.037	.040	0.88	0.95	1.02
Standoff §	A1	.000	.002	.004	0.01	0.06	0.10
Overall Width	E	.083	.093	.104	2.10	2.37	2.64
Molded Package Width	E1	.047	.051	.055	1.20	1.30	1.40
Overall Length	D	.110	.115	.120	2.80	2.92	3.04
Foot Length	L	.014	.018	.022	0.35	0.45	0.55
Foot Angle	φ	0	5	10	0	5	10
Lead Thickness	c	.004	.006	.007	0.09	0.14	0.18
Lead Width	B	.015	.017	.020	0.37	0.44	0.51
Mold Draft Angle Top	α	0	5	10	0	5	10
Mold Draft Angle Bottom	β	0	5	10	0	5	10

* Controlling Parameter
 § Significant Characteristic

Notes:
 Dimensions D and E1 do not include mold flash or protrusions. Mold flash or protrusions shall not exceed .010" (0.254mm) per side.
 JEDEC Equivalent: TO-236
 Drawing No. C04-104



MCP1525/41

NOTES:

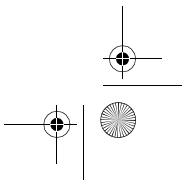
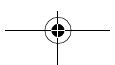
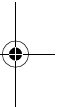
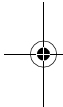
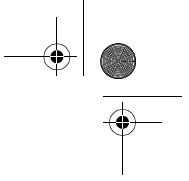

MCP1525/41

APPENDIX A: REVISION HISTORY

Revision C (December 2012)

Added a note to each package outline drawing.

Revision B (February 2005)

The following is the list of modifications:

1. Added bandwidth and capacitor specifications (**Section 1.0 “Electrical Characteristics”**).
2. Moved **Section 1.1 “Specification Descriptions and Test Circuits”** to the specifications section (**Section 1.0 “Electrical Characteristics”**).
3. Corrected plots in **Section 2.0 “Typical Performance Curves”**.
4. Added **Section 3.0 “Pin Descriptions”**.
5. Corrected package markings in **Section 5.0 “Packaging Information”**.
6. Added **Appendix A: “Revision History”**.

Revision A (July 2001)

- Original Release of this Document.

MCP1525/41

NOTES:

MCP1525/41

PRODUCT IDENTIFICATION SYSTEM

To order or obtain information, e.g., on pricing or delivery, refer to the factory or the listed sales office.

<u>PART NO.</u>	<u>X</u>	<u>/XX</u>
Device	Temperature Range	Package
Device	MCP1525: = 2.5V Voltage Reference MCP1541: = 4.096 Voltage Reference	
Temperature Range	I = -40°C to +85°C	
Package	TO = TO-92, Plastic Transistor Outline, 3-Lead TT = SOT23, Plastic Small Outline Transistor, 3-Lead	

Examples:

- a) MCP1525T-I/TT: Tape and Reel, Industrial Temperature, SOT23 package.
- b) MCP1525-I/TO: Industrial Temperature, TO-92 package.
- c) MCP1541T-I/TT: Tape and Reel, Industrial Temperature, SOT23 package.
- d) MCP1541-I/TO: Industrial Temperature, TO-92 package.



MCP1525/41

NOTES:

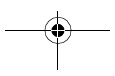
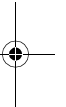
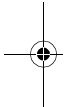

Note the following details of the code protection feature on Microchip devices:

- Microchip products meet the specification contained in their particular Microchip Data Sheet.
- Microchip believes that its family of products is one of the most secure families of its kind on the market today, when used in the intended manner and under normal conditions.
- There are dishonest and possibly illegal methods used to breach the code protection feature. All of these methods, to our knowledge, require using the Microchip products in a manner outside the operating specifications contained in Microchip's Data Sheets. Most likely, the person doing so is engaged in theft of intellectual property.
- Microchip is willing to work with the customer who is concerned about the integrity of their code.
- Neither Microchip nor any other semiconductor manufacturer can guarantee the security of their code. Code protection does not mean that we are guaranteeing the product as "unbreakable."

Code protection is constantly evolving. We at Microchip are committed to continuously improving the code protection features of our products. Attempts to break Microchip's code protection feature may be a violation of the Digital Millennium Copyright Act. If such acts allow unauthorized access to your software or other copyrighted work, you may have a right to sue for relief under that Act.

Information contained in this publication regarding device applications and the like is provided only for your convenience and may be superseded by updates. It is your responsibility to ensure that your application meets with your specifications. MICROCHIP MAKES NO REPRESENTATIONS OR WARRANTIES OF ANY KIND WHETHER EXPRESS OR IMPLIED, WRITTEN OR ORAL, STATUTORY OR OTHERWISE, RELATED TO THE INFORMATION, INCLUDING BUT NOT LIMITED TO ITS CONDITION, QUALITY, PERFORMANCE, MERCHANTABILITY OR FITNESS FOR PURPOSE. Microchip disclaims all liability arising from this information and its use. Use of Microchip devices in life support and/or safety applications is entirely at the buyer's risk, and the buyer agrees to defend, indemnify and hold harmless Microchip from any and all damages, claims, suits, or expenses resulting from such use. No licenses are conveyed, implicitly or otherwise, under any Microchip intellectual property rights.

Trademarks

The Microchip name and logo, the Microchip logo, dsPIC, FlashFlex, KEELOQ, KEELOQ logo, MPLAB, PIC, PICmicro, PICSTART, PIC³² logo, rPIC, SST, SST Logo, SuperFlash and UNI/O are registered trademarks of Microchip Technology Incorporated in the U.S.A. and other countries.

FilterLab, Hampshire, HI-TECH C, Linear Active Thermistor, MTP, SEEVAL and The Embedded Control Solutions Company are registered trademarks of Microchip Technology Incorporated in the U.S.A.

Silicon Storage Technology is a registered trademark of Microchip Technology Inc. in other countries.

Analog-for-the-Digital Age, Application Maestro, BodyCom, chipKIT, chipKIT logo, CodeGuard, dsPICDEM, dsPICDEM.net, dsPICworks, dsSPEAK, ECAN, ECONOMONITOR, FanSense, HI-TIDE, In-Circuit Serial Programming, ICSP, Mindi, MiWi, MPASM, MPF, MPLAB Certified logo, MPLIB, MPLINK, mTouch, Omniclient Code Generation, PICC, PICC-18, PICDEM, PICDEM.net, PICkit, PICtail, REAL ICE, rLAB, Select Mode, SQI, Serial Quad I/O, Total Endurance, TSHARC, UniWinDriver, WiperLock, ZENA and Z-Scale are trademarks of Microchip Technology Incorporated in the U.S.A. and other countries.

SQTP is a service mark of Microchip Technology Incorporated in the U.S.A.

GestIC and ULPP are registered trademarks of Microchip Technology Germany II GmbH & Co. & KG, a subsidiary of Microchip Technology Inc., in other countries.

All other trademarks mentioned herein are property of their respective companies.

© 2001-2012, Microchip Technology Incorporated, Printed in the U.S.A., All Rights Reserved.

 Printed on recycled paper.

ISBN: 9781620768853

**QUALITY MANAGEMENT SYSTEM
CERTIFIED BY DNV
= ISO/TS 16949 =**

Microchip received ISO/TS-16949:2009 certification for its worldwide headquarters, design and wafer fabrication facilities in Chandler and Tempe, Arizona; Gresham, Oregon and design centers in California and India. The Company's quality system processes and procedures are for its PIC[®] MCUs and dsPIC[®] DSCs, KEELOQ[®] code hopping devices, Serial EEPROMs, microperipherals, nonvolatile memory and analog products. In addition, Microchip's quality system for the design and manufacture of development systems is ISO 9001:2000 certified.



Worldwide Sales and Service

AMERICAS

Corporate Office
2355 West Chandler Blvd.
Chandler, AZ 85224-6199
Tel: 480-792-7200
Fax: 480-792-7277
Technical Support:
<http://www.microchip.com/support>
Web Address:
www.microchip.com

Atlanta
Duluth, GA
Tel: 678-957-9614
Fax: 678-957-1455

Boston
Westborough, MA
Tel: 774-760-0087
Fax: 774-760-0088

Chicago
Itasca, IL
Tel: 630-285-0071
Fax: 630-285-0075

Cleveland
Independence, OH
Tel: 216-447-0464
Fax: 216-447-0643

Dallas
Addison, TX
Tel: 972-818-7423
Fax: 972-818-2924

Detroit
Farmington Hills, MI
Tel: 248-538-2250
Fax: 248-538-2260

Indianapolis
Noblesville, IN
Tel: 317-773-8323
Fax: 317-773-5453

Los Angeles
Mission Viejo, CA
Tel: 949-462-9523
Fax: 949-462-9608

Santa Clara
Santa Clara, CA
Tel: 408-961-6444
Fax: 408-961-6445

Toronto
Mississauga, Ontario,
Canada
Tel: 905-673-0699
Fax: 905-673-6509

ASIA/PACIFIC

Asia Pacific Office
Suites 3707-14, 37th Floor
Tower 6, The Gateway
Harbour City, Kowloon
Hong Kong
Tel: 852-2401-1200
Fax: 852-2401-3431

Australia - Sydney
Tel: 61-2-9868-6733
Fax: 61-2-9868-6755

China - Beijing
Tel: 86-10-8569-7000
Fax: 86-10-8528-2104

China - Chengdu
Tel: 86-28-8665-5511
Fax: 86-28-8665-7889

China - Chongqing
Tel: 86-23-8980-9588
Fax: 86-23-8980-9500

China - Hangzhou
Tel: 86-571-2819-3187
Fax: 86-571-2819-3189

China - Hong Kong SAR
Tel: 852-2943-5100
Fax: 852-2401-3431

China - Nanjing
Tel: 86-25-8473-2460
Fax: 86-25-8473-2470

China - Qingdao
Tel: 86-532-8502-7355
Fax: 86-532-8502-7205

China - Shanghai
Tel: 86-21-5407-5533
Fax: 86-21-5407-5066

China - Shenyang
Tel: 86-24-2334-2829
Fax: 86-24-2334-2393

China - Shenzhen
Tel: 86-755-8864-2200
Fax: 86-755-8203-1760

China - Wuhan
Tel: 86-27-5980-5300
Fax: 86-27-5980-5118

China - Xian
Tel: 86-29-8833-7252
Fax: 86-29-8833-7256

China - Xiamen
Tel: 86-592-2388138
Fax: 86-592-2388130

China - Zhuhai
Tel: 86-756-3210040
Fax: 86-756-3210049

ASIA/PACIFIC

India - Bangalore
Tel: 91-80-3090-4444
Fax: 91-80-3090-4123

India - New Delhi
Tel: 91-11-4160-8631
Fax: 91-11-4160-8632

India - Pune
Tel: 91-20-2566-1512
Fax: 91-20-2566-1513

Japan - Osaka
Tel: 81-6-6152-7160
Fax: 81-6-6152-9310

Japan - Tokyo
Tel: 81-3-6880-3770
Fax: 81-3-6880-3771

Korea - Daegu
Tel: 82-53-744-4301
Fax: 82-53-744-4302

Korea - Seoul
Tel: 82-2-554-7200
Fax: 82-2-558-5932 or
82-2-558-5934

Malaysia - Kuala Lumpur
Tel: 60-3-6201-9857
Fax: 60-3-6201-9859

Malaysia - Penang
Tel: 60-4-227-8870
Fax: 60-4-227-4068

Philippines - Manila
Tel: 63-2-634-9065
Fax: 63-2-634-9069

Singapore
Tel: 65-6334-8870
Fax: 65-6334-8850

Taiwan - Hsin Chu
Tel: 886-3-5778-366
Fax: 886-3-5770-955

Taiwan - Kaohsiung
Tel: 886-7-213-7828
Fax: 886-7-330-9305

Taiwan - Taipei
Tel: 886-2-2508-8600
Fax: 886-2-2508-0102

Thailand - Bangkok
Tel: 66-2-694-1351
Fax: 66-2-694-1350

EUROPE

Austria - Wels
Tel: 43-7242-2244-39
Fax: 43-7242-2244-393

Denmark - Copenhagen
Tel: 45-4450-2828
Fax: 45-4485-2829

France - Paris
Tel: 33-1-69-53-63-20
Fax: 33-1-69-30-90-79

Germany - Munich
Tel: 49-89-627-144-0
Fax: 49-89-627-144-44

Italy - Milan
Tel: 39-0331-742611
Fax: 39-0331-466781

Netherlands - Drunen
Tel: 31-416-690399
Fax: 31-416-690340

Spain - Madrid
Tel: 34-91-708-08-90
Fax: 34-91-708-08-91

UK - Wokingham
Tel: 44-118-921-5869
Fax: 44-118-921-5820

11/29/12

X-ON Electronics

Largest Supplier of Electrical and Electronic Components

Click to view similar products for [Voltage References](#) category:

Click to view products by [Microchip](#) manufacturer:

Other Similar products are found below :

[REF01J/883](#) [5962-8686103XC](#) [NCV431BVDMR2G](#) [LT6654AMPS6-2.048#TRMPBF](#) [SCV431AIDMR2G](#) [LT1019AIS8-2.5](#)
[LT6654AMPS6-3.3#TRM](#) [SC431ILPRAG](#) [AP432AQG-7](#) [LM4040B25QFTA](#) [NJM2823F-TE1](#) [TL431-A](#) [MCP1502T-18E/CHY](#) [MCP1502T-40E/CHY](#) [TL4050B25QDBZR](#) [TL431ACZ](#) [KA431SLMF2TF](#) [KA431SMF2TF](#) [KA431SMFTF](#) [LM4041C12ILPR](#) [LM4120AIM5-2.5/NOP](#)
[LM431SCCMFX](#) [TS3330AQPR](#) [REF5040MDREP](#) [LM285BXM-1.2/NOPB](#) [LM385BM-2.5/NOPB](#) [LM4040AIM3-10.0](#) [LM4040BIM3-4.1](#)
[LM4040CIM3-10.0](#) [LM4040CIM3X-2.0/NOPB](#) [LM4041BSD-122GT3](#) [LM4041QDIM3-ADJ/NO](#) [LM4050QAEM3X4.1/NOPB](#)
[LM4051BIM3-ADJ/NOPB](#) [LM4051CIM3X-1.2/NOPB](#) [LM4128CMF-1.8/NOPB](#) [LM4132DMF-1.8/NOPB](#) [LM4132EMF-1.8/NOPB](#)
[LM4132EMF-2.0/NOPB](#) [LM4140CCMX-1.2/NOPB](#) [LM431CIM](#) [LM385BD-2.5R2G](#) [LM385M-2.5/NOPB](#) [LM4030AMF-4.096/NOPB](#)
[LM4040D30ILPR](#) [LM4051CIM3X-ADJ/NOPB](#) [AP432YG-13](#) [AS431ANTR-G1](#) [AS431BZTR-E1](#) [AN431AN-ATRG1](#)