



**MICROCHIP**

---

**MCP1630 Automotive Input  
Triple Output Converter  
Demo Board  
User's Guide**

---

**Note the following details of the code protection feature on Microchip devices:**

- Microchip products meet the specification contained in their particular Microchip Data Sheet.
- Microchip believes that its family of products is one of the most secure families of its kind on the market today, when used in the intended manner and under normal conditions.
- There are dishonest and possibly illegal methods used to breach the code protection feature. All of these methods, to our knowledge, require using the Microchip products in a manner outside the operating specifications contained in Microchip's Data Sheets. Most likely, the person doing so is engaged in theft of intellectual property.
- Microchip is willing to work with the customer who is concerned about the integrity of their code.
- Neither Microchip nor any other semiconductor manufacturer can guarantee the security of their code. Code protection does not mean that we are guaranteeing the product as "unbreakable."

Code protection is constantly evolving. We at Microchip are committed to continuously improving the code protection features of our products. Attempts to break Microchip's code protection feature may be a violation of the Digital Millennium Copyright Act. If such acts allow unauthorized access to your software or other copyrighted work, you may have a right to sue for relief under that Act.

---

Information contained in this publication regarding device applications and the like is provided only for your convenience and may be superseded by updates. It is your responsibility to ensure that your application meets with your specifications. MICROCHIP MAKES NO REPRESENTATIONS OR WARRANTIES OF ANY KIND WHETHER EXPRESS OR IMPLIED, WRITTEN OR ORAL, STATUTORY OR OTHERWISE, RELATED TO THE INFORMATION, INCLUDING BUT NOT LIMITED TO ITS CONDITION, QUALITY, PERFORMANCE, MERCHANTABILITY OR FITNESS FOR PURPOSE. Microchip disclaims all liability arising from this information and its use. Use of Microchip devices in life support and/or safety applications is entirely at the buyer's risk, and the buyer agrees to defend, indemnify and hold harmless Microchip from any and all damages, claims, suits, or expenses resulting from such use. No licenses are conveyed, implicitly or otherwise, under any Microchip intellectual property rights.

**Trademarks**

The Microchip name and logo, the Microchip logo, Accuron, dsPIC, KEELOQ, microID, MPLAB, PIC, PICmicro, PICSTART, PRO MATE, PowerSmart, rPIC and SmartShunt are registered trademarks of Microchip Technology Incorporated in the U.S.A. and other countries.

AmpLab, FilterLab, Migratable Memory, MXDEV, MXLAB, SEEVAL, SmartSensor and The Embedded Control Solutions Company are registered trademarks of Microchip Technology Incorporated in the U.S.A.

Analog-for-the-Digital Age, Application Maestro, CodeGuard, dsPICDEM, dsPICDEM.net, dsPICworks, ECAN, ECONOMONITOR, FanSense, FlexROM, fuzzyLAB, In-Circuit Serial Programming, ICSP, ICEPIC, Linear Active Thermistor, Mindi, MiWi, MPASM, MPLIB, MPLINK, PICkit, PICDEM, PICDEM.net, PICLAB, PICtail, PowerCal, PowerInfo, PowerMate, PowerTool, REAL ICE, rLAB, rPICDEM, Select Mode, Smart Serial, SmartTel, Total Endurance, UNI/O, WiperLock and ZENA are trademarks of Microchip Technology Incorporated in the U.S.A. and other countries.

SQTP is a service mark of Microchip Technology Incorporated in the U.S.A.

All other trademarks mentioned herein are property of their respective companies.

© 2006, Microchip Technology Incorporated, Printed in the U.S.A., All Rights Reserved.

 Printed on recycled paper.

**QUALITY MANAGEMENT SYSTEM**  
**CERTIFIED BY DNV**  
**== ISO/TS 16949:2002 ==**

*Microchip received ISO/TS-16949:2002 certification for its worldwide headquarters, design and wafer fabrication facilities in Chandler and Tempe, Arizona, Gresham, Oregon and Mountain View, California. The Company's quality system processes and procedures are for its PICmicro® 8-bit MCUs, KEELOQ® code hopping devices, Serial EEPROMs, microperipherals, nonvolatile memory and analog products. In addition, Microchip's quality system for the design and manufacture of development systems is ISO 9001:2000 certified.*



# MCP1630 AUTOMOTIVE INPUT TRIPLE OUTPUT CONVERTER DEMO BOARD USER'S GUIDE

---

---

## Table of Contents

---

---

<b>Preface</b> .....	<b>1</b>
Introduction.....	1
Document Layout .....	1
Conventions Used in this Guide .....	2
Recommended Reading.....	2
The Microchip Web Site .....	3
Customer Support .....	3
Document Revision History .....	3
<b>Chapter 1. Product Overview</b> .....	<b>5</b>
1.1 Introduction .....	5
1.2 What is the MCP1630 Automotive Input Triple Output Converter Demo Board? .....	6
1.3 What the MCP1630 Automotive Input Triple Output Converter Demo Board kit includes .....	6
<b>Chapter 2. Installation and Operation</b> .....	<b>7</b>
2.1 Introduction .....	7
2.2 Features .....	7
2.3 Getting Started .....	8
<b>Appendix A. Schematic and Layouts</b> .....	<b>11</b>
A.1 Introduction .....	11
A.2 Board – Schematic .....	12
A.3 Board – Top Silk Layer .....	13
A.4 Board – Top Metal Layer .....	14
A.5 Board – Bottom Metal Layer .....	15
<b>Appendix B. Bill Of Materials (BOM)</b> .....	<b>17</b>
<b>Appendix C. Demo Board Firmware</b> .....	<b>19</b>
C.1 Device Firmware .....	19
<b>Worldwide Sales and Service</b> .....	<b>20</b>

**NOTES:**



# MCP1630 AUTOMOTIVE INPUT TRIPLE OUTPUT CONVERTER DEMO BOARD USER'S GUIDE

## Preface

### NOTICE TO CUSTOMERS

All documentation becomes dated, and this manual is no exception. Microchip tools and documentation are constantly evolving to meet customer needs, so some actual dialogs and/or tool descriptions may differ from those in this document. Please refer to our web site ([www.microchip.com](http://www.microchip.com)) to obtain the latest documentation available.

Documents are identified with a "DS" number. This number is located on the bottom of each page, in front of the page number. The numbering convention for the DS number is "DSXXXXA", where "XXXX" is the document number and "A" is the revision level of the document.

For the most up-to-date information on development tools, see the MPLAB® IDE on-line help. Select the Help menu, and then Topics to open a list of available on-line help files.

## INTRODUCTION

This chapter contains general information that will be useful to know before using the MCP1630 Automotive Input Triple Output Converter Demo Board. Items discussed in this chapter include:

- Document Layout
- Conventions Used in this Guide
- Recommended Reading
- The Microchip Web Site
- Customer Support
- Document Revision History

## DOCUMENT LAYOUT

This document describes how to use the MCP1630 Automotive Input Triple Output Converter Demo Board. The manual layout is as follows:

- **Chapter 1. "Product Overview"** – Important information about the MCP1630 Automotive Input Triple Output Converter Demo Board.
- **Chapter 2. "Installation and Operation"** – Includes instructions on how to get started with this user's guide and a description of the user's guide.
- **Appendix A. "Schematic and Layouts"** – Shows the schematic and layout diagrams for the MCP1630 Automotive Input Triple Output Converter Demo Board.
- **Appendix B. "Bill Of Materials (BOM)"** – Lists the parts used to build the MCP1630 Automotive Input Triple Output Converter Demo Board.
- **Appendix C. "Demo Board Firmware"** – Provides information about the application firmware and where the source code can be found.

## CONVENTIONS USED IN THIS GUIDE

This manual uses the following documentation conventions:

### DOCUMENTATION CONVENTIONS

Description	Represents	Examples
<b>Arial font:</b>		
Italic characters	Referenced books	<i>MPLAB® IDE User's Guide</i>
	Emphasized text	...is the <i>only</i> compiler...
Initial caps	A window	the Output window
	A dialog	the Settings dialog
	A menu selection	select Enable Programmer
Quotes	A field name in a window or dialog	"Save project before build"
Underlined, italic text with right angle bracket	A menu path	<u><i>File&gt;Save</i></u>
Bold characters	A dialog button	Click <b>OK</b>
	A tab	Click the <b>Power</b> tab
'bnnnn	A binary number where <i>n</i> is a digit	'b00100, 'b10
Text in angle brackets < >	A key on the keyboard	Press <Enter>, <F1>
<b>Courier font:</b>		
Plain Courier	Sample source code	#define START
	Filenames	autoexec.bat
	File paths	c:\mcc18\h
	Keywords	_asm, _endasm, static
	Command-line options	-Opa+, -Opa-
	Bit values	0, 1
Italic Courier	A variable argument	<i>file.o</i> , where <i>file</i> can be any valid filename
0xnnnn	A hexadecimal number where <i>n</i> is a hexadecimal digit	0xFFFF, 0x007A
Square brackets [ ]	Optional arguments	mcc18 [options] <i>file</i> [options]
Curly brackets and pipe character: {   }	Choice of mutually exclusive arguments; an OR selection	errorlevel {0 1}

## RECOMMENDED READING

This user's guide describes how to use MCP1630 Automotive Input Triple Output Converter Demo Board. The following Microchip documents are available on our web site ([www.microchip.com](http://www.microchip.com)) and recommended as supplemental reference resources.

### **MCP1630/MCP1630V Data Sheet, "High-Speed, Microcontroller-Adaptable, Pulse Width Modulator" (DS21896)**

This data sheet provides detailed information regarding the MCP1630/MCP1630V, product family.

### **PIC12F683 Data Sheet, "8-Pin Flash-Based, 8-Bit CMOS Microcontrollers with Nano Watt Technology" (DS41211)**

This data sheet provides detailed information regarding the PIC12F683 product family

## THE MICROCHIP WEB SITE

Microchip provides online support via our web site at [www.microchip.com](http://www.microchip.com). This web site is used as a means to make files and information easily available to customers. Accessible by using your favorite Internet browser, the web site contains the following information:

- **Product Support** – Data sheets and errata, application notes and sample programs, design resources, user's guides and hardware support documents, latest software releases and archived software
- **General Technical Support** – Frequently Asked Questions (FAQs), technical support requests, online discussion groups, Microchip consultant program member listing
- **Business of Microchip** – Product selector and ordering guides, latest Microchip press releases, listing of seminars and events, listings of Microchip sales offices, distributors and factory representatives

## CUSTOMER SUPPORT

Users of Microchip products can receive assistance through several channels:

- Distributor or Representative
- Local Sales Office
- Field Application Engineer (FAE)
- Technical Support
- Development Systems Information Line

Customers should contact their distributor, representative or field application engineer for support. Local sales offices are also available to help customers. A listing of sales offices and locations is included in the back of this document.

Technical support is available through the web site at: <http://support.microchip.com>

## DOCUMENT REVISION HISTORY

### Revision A (September 2006)

- Initial Release of this Document.

NOTES:



## Chapter 1. Product Overview

### 1.1 INTRODUCTION

The proliferation of distributed power supplies is expected to accelerate their use in future generation cars and continue to incorporate increasingly complex electronic systems. Distributed power supplies or "point-of-load" power supplies are being used increasingly through out. These power supply units (PSUs) are responsible for stepping up (or down) the input bus voltage, to power a multitude of electronic subsystems. Examples of these electronic systems are collision avoidance radar, adaptive cruise control, tire pressure monitoring, navigation systems, hands-free cellular phones, and other wireless connectivity.

The majority of mid- to high-end automobiles produced today come with a DVD-based GPS navigation system as standard equipment. However, designing a power supply to handle all the different voltage rails within such a system can prove to be as complex as designing the power-supply system for a notebook PC. The 5V and 3.3V rails are typically the system bus. The 1.5V and 1.2V rails are used to power the CPU and DSP-core voltages, respectively. The power levels of these two rails are usually between 3W and 5W each.

Automotive subsystems with their inherent high voltage transients and high efficiency requirements place increasing demands on power supply designs. These supplies must provide high power, high efficiency and low noise from a very compact footprint and must maintain a high efficiency over a wide range of operational input voltages.

The MCP1630/MCP1630V High-Speed, Microcontroller-Adaptable Pulse Width Modulator is capable of maintaining output regulation with no adverse effects on system performance or reliability. The MCP1630 Automotive Input Triple Output Converter Demo Board provides a better choice for automotive application design and providing high efficiency and also providing a tight Line, Load and Cross regulation for the three outputs.

This chapter covers the following topics.

- What is the MCP1630 Automotive Input Triple Output Converter Demo Board?
- What the MCP1630 Automotive Input Triple Output Converter Demo Board Kit includes.

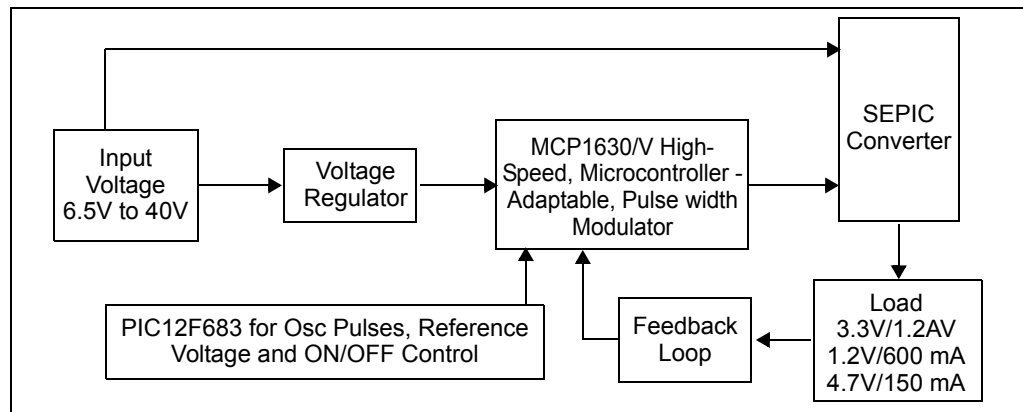

**FIGURE 1-1:** MCP1630 Automotive Input Triple Output Converter Demo Board Block Diagram.

### 1.2 WHAT IS THE MCP1630 AUTOMOTIVE INPUT TRIPLE OUTPUT CONVERTER DEMO BOARD?

The MCP1630 Automotive Input Triple Output Converter Demo Board demonstrates the use of a SEPIC topology for Automotive applications. The board also serves as a platform to evaluate the MCP1630 device.

The MCP1630 inputs were developed to be easily attached to the I/O of a MCU. The MCU supplies the oscillator pulses and reference voltage ( $V_{REF}$ ) to the MCP1630 to provide the most flexible and adaptable power system. The power system switching frequency and maximum duty cycle are set using the I/O of the MCU. The reference input to high speed PWM can be external, a D/A Converter (DCA) output or as simple as an I/O output from the MCU. This enables the power system to adapt to, many external signals and variables in order to optimize performance and facilitate calibration.

This board utilizes Microchip's MCP1630 (High-Speed, Microcontroller-Adaptable, PWM MSOP8) integrated with PIC12F683 (Flash MCU SOIC8) in automotive application. Under normal operation, the supply lines can range between 6.5V - 40V. The converter is capable of delivering three different output voltages of 3.3V at 1.2A load current, 1.2V at 600 mA load current and 4.7V at 150 mA load current, respectively. The Line regulation, Load regulation and Cross regulation is within  $\pm 5\%$  on  $V_{OUT1}$ ,  $\pm 5\%$  on  $V_{OUT2}$  and  $\pm 10\%$  on  $V_{OUT3}$  for the variation in load from 50% to 100%.

### 1.3 WHAT THE MCP1630 AUTOMOTIVE INPUT TRIPLE OUTPUT CONVERTER DEMO BOARD KIT INCLUDES

This MCP1630 Automotive Input Triple Output Converter Demo Board Kit includes:

- MCP1630 Automotive Input Triple Output Converter Demo Board (102-00067)
- Analog and Interface Products Demonstration Boards CD-ROM (DS21912)
  - MCP1630 Automotive Input Triple Output Converter Demo Board User's Guide (DS51627)



# MCP1630 AUTOMOTIVE INPUT TRIPLE OUTPUT CONVERTER DEMO BOARD USER'S GUIDE

---

---

## Chapter 2. Installation and Operation

---

---

### 2.1 INTRODUCTION

The MCP1630 Automotive Input Triple Output Converter Demo Board demonstrates Microchip's high speed pulse width modulator (PWM) used for Automotive application. When used in conjunction with a microcontroller, the MCP1630 will control the power system duty cycle to provide regulated output voltage. The PIC12F683 microcontroller is used to provide oscillator pulses at switching frequency of 250 kHz and set maximum duty cycle. The MCP1630 generates duty cycle based on various external inputs. External signals include the input oscillator pulses from PIC12F683, the reference voltage and the feed back voltage. The output signal is a square-wave pulse given to drive the MOSFET.

The PIC12F683 microcontroller is programmable, allowing the user to modify or develop their own firmware routines to further evaluate the MCP1630 in this application.

### 2.2 FEATURES

The MCP1630 Automotive Input Triple Output Converter Demo Board has the following features:

- Compact size for a Triple output Converter
- Wide Input voltage range from 6.5V to 40V
- Programmable output voltage and ON/OFF control using the PIC microcontroller
- Provide line regulation, load regulation and cross regulation of  $\pm 5\%$  on  $V_{OUT1}$  (3.3V),  $\pm 5\%$  on  $V_{OUT2}$  (1.2V) and  $\pm 10\%$  on  $V_{OUT3}$  (4.7V) for load variation from 50% to 100%
- High efficiency over entire operating input voltage range
- PIC12F683 is used to generate reference Voltage and Oscillator signal at 250 kHz frequency at maximum duty cycle
- Proprietary features can be added by modifying the firmware contained in the PIC12F683
- Factory programmed source code is available

## 2.3 GETTING STARTED

The MCP1630 Automotive Input Triple Output Converter Demo Board is fully assembled and tested for Automotive Input. The board requires the use of an external input voltage source (+6.5V to 40V) and external load for three outputs.

### 2.3.1 Power Input and Output Connection

#### 2.3.1.1 POWERING THE MCP1630 AUTOMOTIVE INPUT TRIPLE OUTPUT CONVERTER DEMO BOARD

1. Connect the positive side of the input source (+) to TP2. Connect the negative or return side (-) of input source to TP1. Refer to figure 2-1. The input voltage should be limited from 6.5V to 40V range. As the input voltage is applied and the system powers up, the firmware program of the PIC12F683 device will initialize and help the converter remain in low-power sleep mode (<0.1 uA) until the SW1 push button is pressed by the user.
2. Once the SW1 push button is pressed, the MCP1630 Automotive Input Triple Output Converter Demo Board is powered on delivering the three output voltages of 3.3V at 1.2A (Maximum current), 1.2V at 600 mA (Maximum current) and 4.7V at 150 mA (Maximum current) respectively.
3. Again, a subsequent pressing of the SW1 push button during normal operation of the MCP1630 Automotive Input Triple Output Converter Demo Board will power-off the converter.

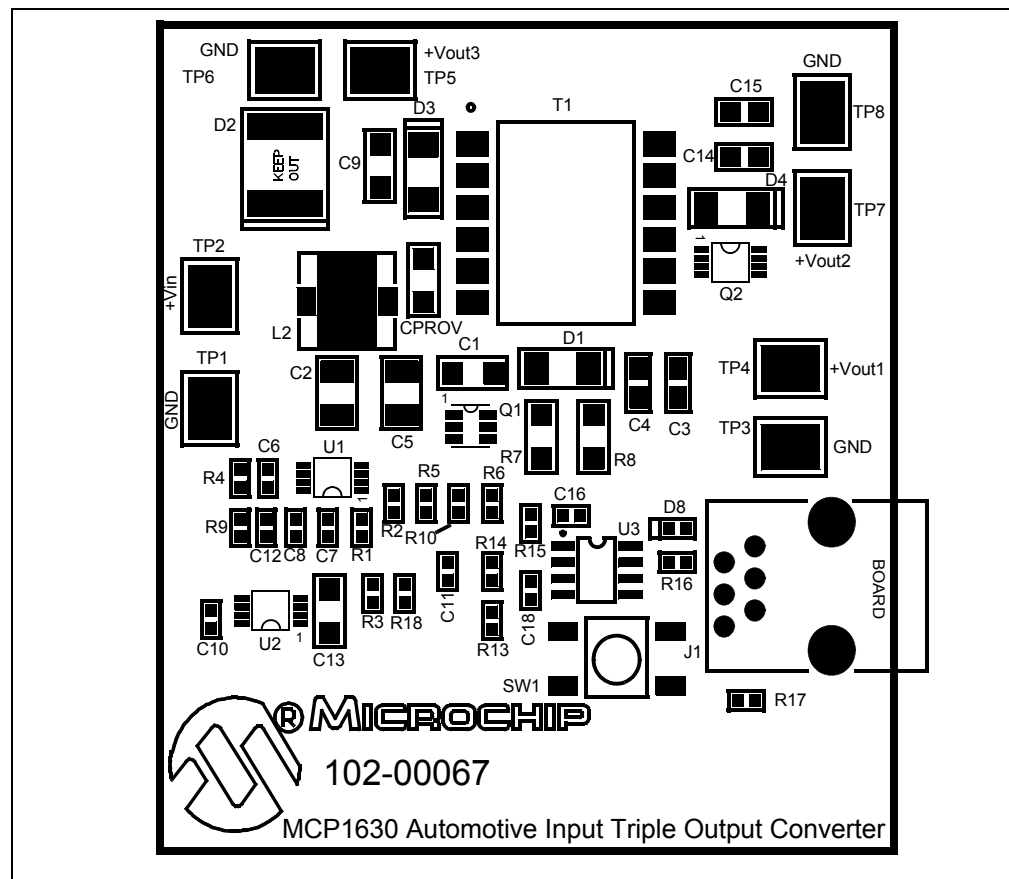

FIGURE 2-1: Setup Configuration Diagram.

## 2.3.1.2 APPLYING LOAD TO MCP1630 AUTOMOTIVE INPUT TRIPLE OUTPUT CONVERTER DEMO BOARD

A variable resistive load can be used to verify the line regulation, load regulation and cross regulation. The load resistance for the three outputs can be connected accordingly. Note that the currents should not exceed the maximum current limit of individual outputs i.e: 1.2A (maximum) for  $V_{OUT1}$ , 600 mA (maximum) for  $V_{OUT2}$  and 150 mA (maximum) for  $V_{OUT3}$ , respectively. The load resistance is connected between the test points TP3 and TP4 for  $V_{OUT1}$ , between test points TP7 and TP8 for  $V_{OUT2}$  and between test points TP5 and TP6 for  $V_{OUT3}$ . To measure the output voltage, connect the common point of multimeter to TP3 and the positive terminal to TP4 for  $V_{OUT1}$ . Similarly, to measure the output voltages of  $V_{OUT2}$  and  $V_{OUT3}$ , connect the common point of multimeter to TP8 for  $V_{OUT2}$  and TP6 for  $V_{OUT3}$  and the positive terminal to TP7 for  $V_{OUT2}$  and TP5 for  $V_{OUT3}$ .

The load regulation and cross regulation can be verified by varying the load from 50% to 100%, with different combination of loads on all the outputs. Similarly, by varying the line voltage from 6.5V to 40V and checking the output voltage, the line regulation can be calculated.

### Evaluating the Application

The best way to evaluate the MCP1630 Automotive Input Triple Output Converter Demo Board is to dig into the circuit. Measure voltages and currents with a DVM and probe the board with an oscilloscope.

The firmware program in the PIC12F683 can also be edited to modify the operation of the application.

### Firmware

The PIC12F683 comes pre programmed with firmware to operate the system as described above. The file listing and firmware flow diagram are shown in **Appendix C. "Demo Board Firmware"**.

The program is fairly simple and straight forward. There is an initialization routine at the beginning of the program.

The internal oscillator clock is set to 8 MHz. The TRISIO is configured to set GP2 (Oscillator pulses to the MCP1630) and GP4 ( $V_{REF}$  Voltage to MCP1630) as an output port and GP3 (Switch SW1) as Input Port. The OPTION register is configured to wake-up on Port pin change of GP3.

The Capture/Compare/PWM (CCP) module contains a 16-bit register which can operate in PWM mode. The PWM period can be calculated by writing to the PR2 register. The PWM duty cycle is specified by writing to the CCPR1L register and to the CCP1CON <5:4> bits. Up to 10-bit resolution is available. The CCPR1L contains the eight MSBs and the CCP1CON <5:4> contains the two LSBs. This 10-bit value is represented by CCPR1L:CCP1CON<5:4>. The switching frequency is set to 250 kHz.

Upon powering on, the processor enters into SLEEP mode after the ports are initialized and registers configured. The processor wakes-up from SLEEP mode, if the Switch SW1 on GP3 is pressed.

Once the processor is on after the switch SW1 is pressed, the three output voltages of 3.3V, 1.2V and 4.7V are generated by set by generating  $V_{REF}$  voltage and the PWM signal. TMR0 is configured to generate the  $V_{REF}$  voltage.

During normal operation, a subsequent pressing of switch SW1 will make the converter to go into SLEEP mode.

The switch SW1 is used to perform a simple ON/OFF operation.

### Programming

Header J1 is provided for in-circuit programming. This is an optional feature since the demo board comes preprogrammed with firmware to operate the system. The PIC12F683 can be reprogrammed with the Baseline Flash Microcontroller Programmer (BFMP)



# MCP1630 AUTOMOTIVE INPUT TRIPLE OUTPUT CONVERTER DEMO BOARD USER'S GUIDE

---

---

## Appendix A. Schematic and Layouts

---

---

### A.1 INTRODUCTION

This appendix contains the following schematics and layouts for the MCP1630 Automotive Input Triple Output Converter Demo Board:

- Board – Schematic
- Board – Top Silk Layer
- Board – Top Metal Layer
- Board – Bottom Metal Layer

A.2 BOARD – SCHEMATIC

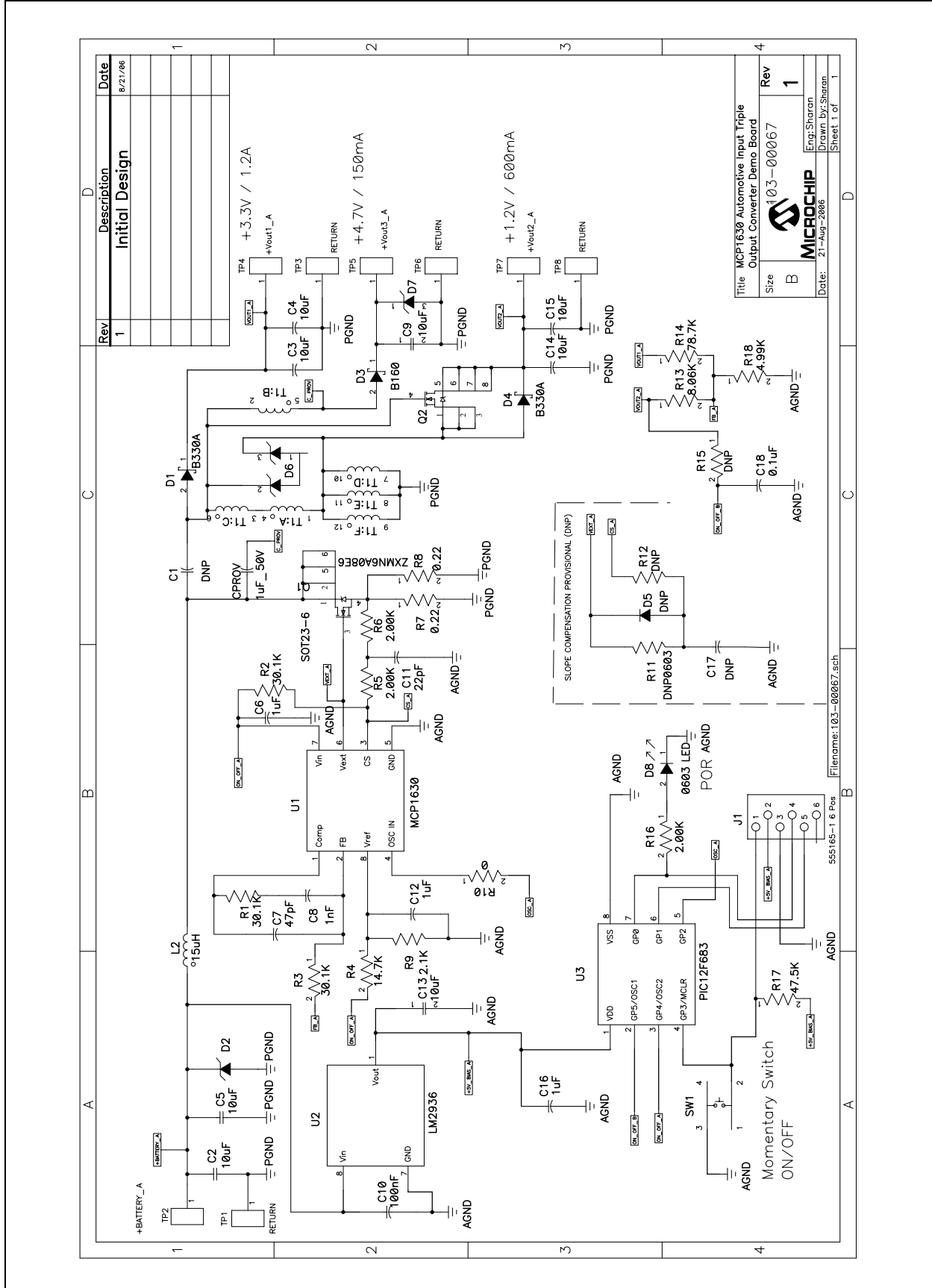



## A.3 BOARD – TOP SILK LAYER

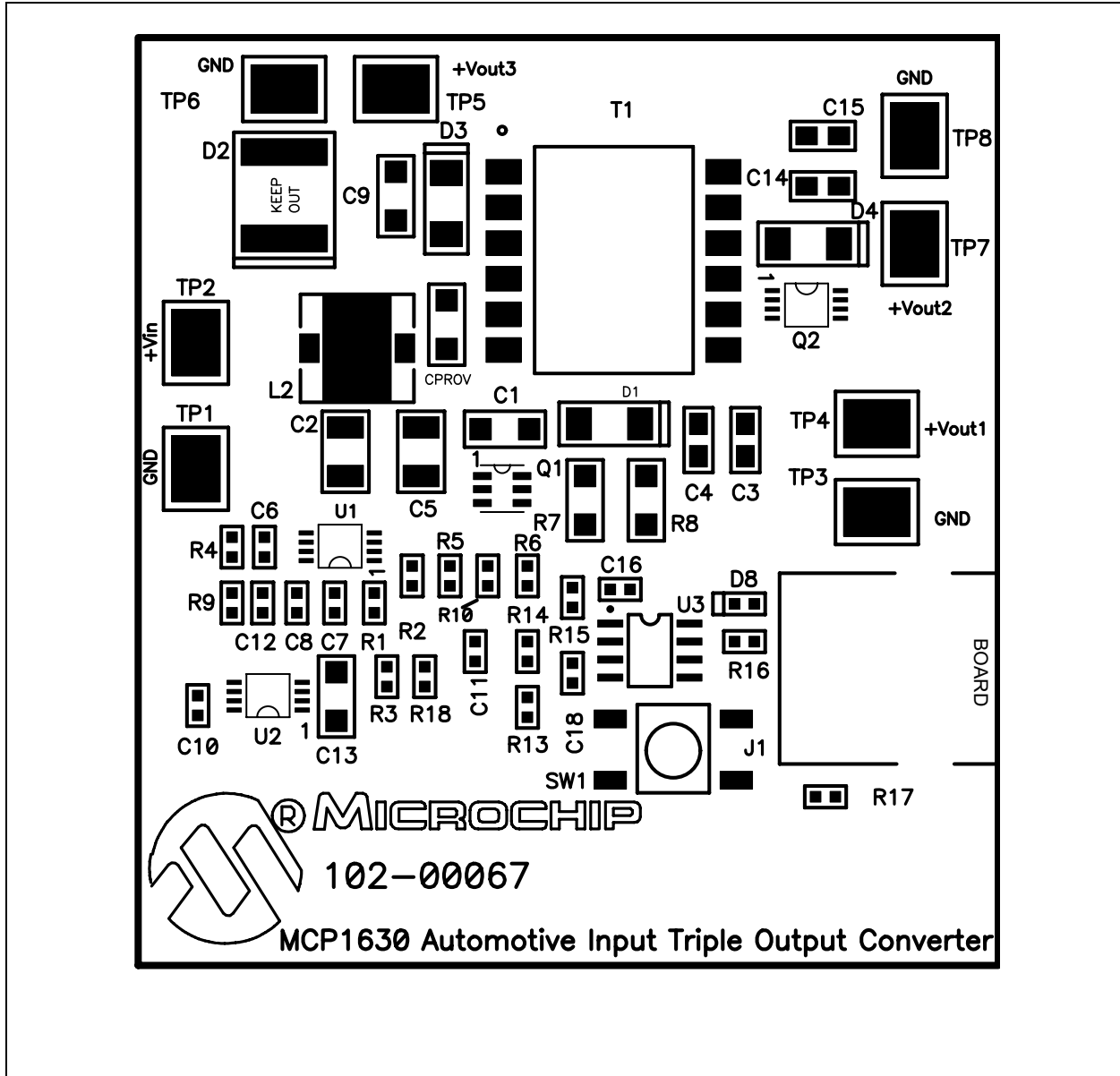

A.4 BOARD – TOP METAL LAYER

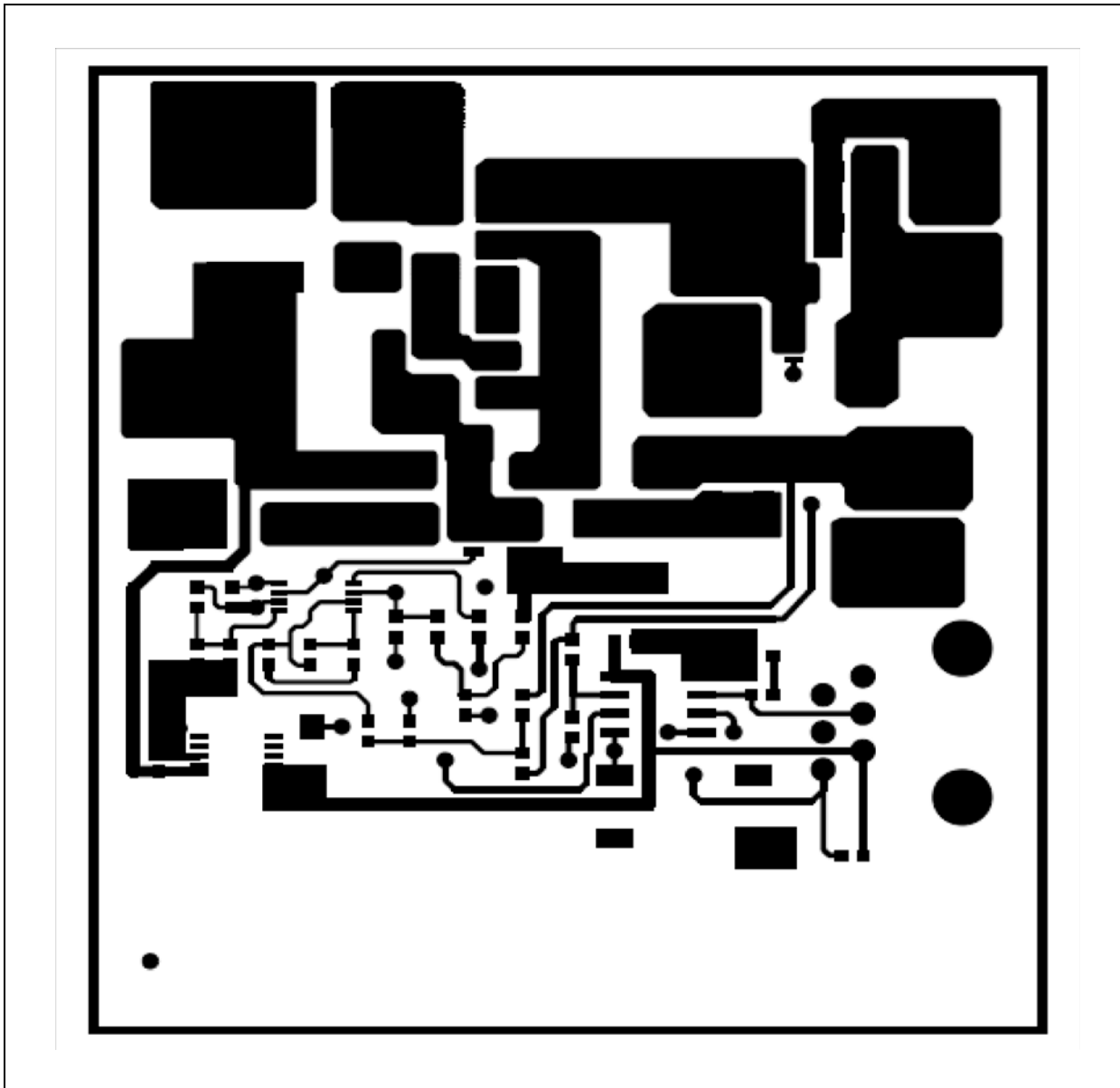

## A.5 BOARD – BOTTOM METAL LAYER

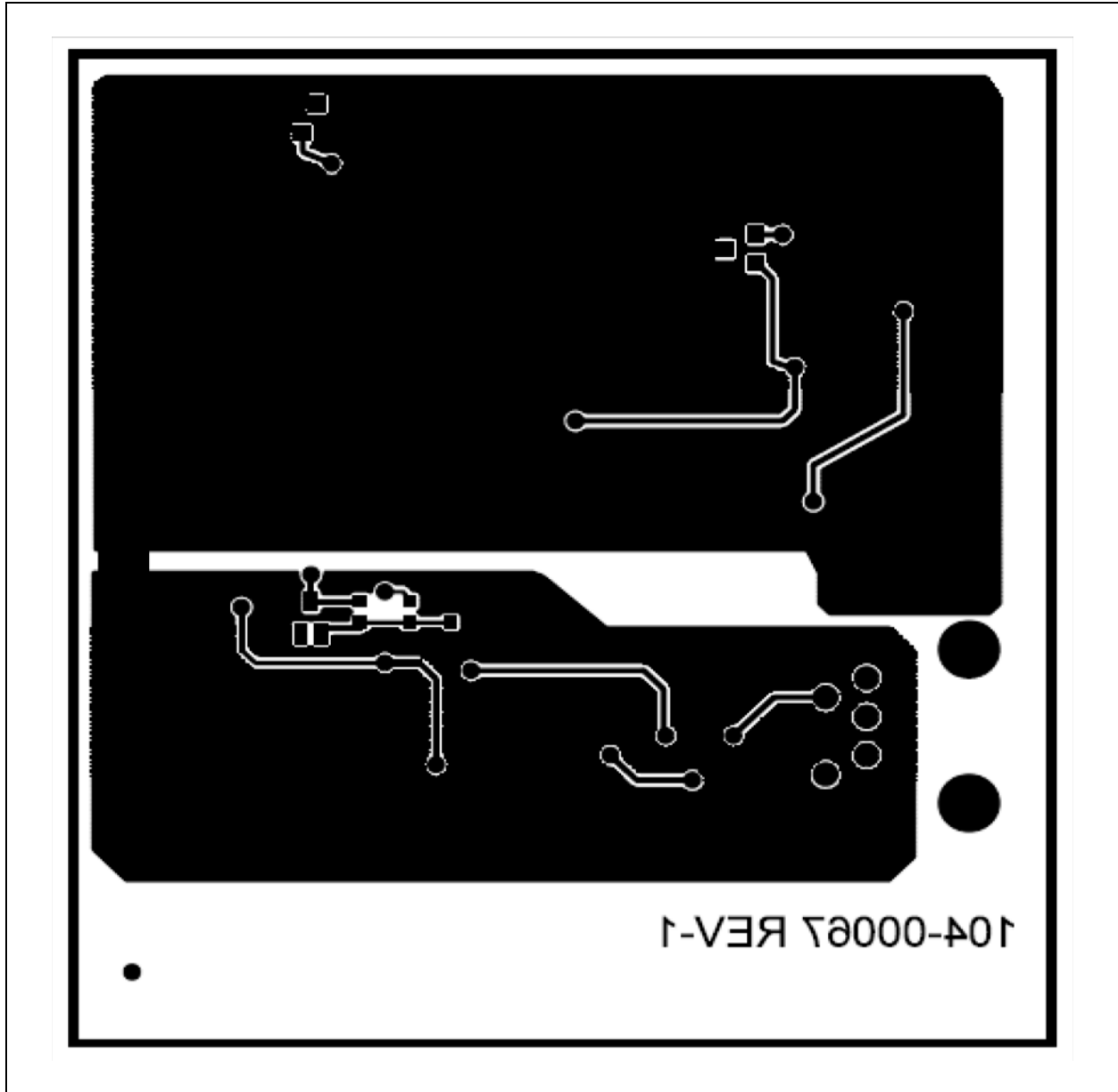

**NOTES:**



# MCP1630 AUTOMOTIVE INPUT TRIPLE OUTPUT CONVERTER DEMO BOARD USER'S GUIDE

## Appendix B. Bill Of Materials (BOM)

**TABLE B-1: BILL OF MATERIALS (BOM)**

Qty	Reference	Description	Manufacturer	Part Number
2	C1,C17	DNP	—	—
2	C2, C5	Cap 10UF 50V Ceramic F 1210	Panasonic® - ECG	ECJ-4YF1H106Z
5	C3, C4, C9,C14, C15	Cap 10UF 6.3V Ceramic X5R 0805	Panasonic - ECG	ECJ-2FB0J106M
2	C6, C16	Cap 1UF 10V Ceramic 0603 X5R	Panasonic - ECG	ECJ-1VB1A105K
1	C7	Cap Ceramic 47PF 50V 0603 SMD	Panasonic - ECG	ECJ-1VC1H470J
1	C8	Cap Ceramic 1000PF 50V NP0 0603	Panasonic - ECG	ECJ-1VC1H102J
1	C10	Cap .1UF 50V Ceramic Y5V 0603	Panasonic - ECG	ECJ-1VF1H104Z
1	C11	Cap Ceramic 22PF 50V 0603 SMD	Panasonic - ECG	ECJ-1VC1H220J
2	C12, C18	Cap .10UF 10V Ceramic X7R 0603	Kemet® Electronics Corp	C0603C104K8RACTU
1	C13	Cap 10UF 10V Ceramic 1206 X5R	Panasonic - ECG	ECJ-3YB1A106M
1	CPROV	Cap Cer 1UF 50V X7R 10% 1206	TDK Corporation	C3216X7R1H105K
2	D1, D4	Diode Schottky 30V 3A SMA	Diodes Inc	B330A-13
2	D2,D5	DNP		
1	D3	Diode Schottky 60V 1A SMA	Diodes Inc	B160-13
1	D6	Diode Zener Dual CA 18V SOT-23	Diodes Inc	AZ23C18-7
1	D7	Diode Zener 350MW 6.2V SOT23	Diodes Inc	BZX84C6V2-7-F
1	D8	LED 660NM Super Red Diff 0603SMD	Lumex® / Opto Components Inc	SML-LX0603SRW-TR
1	J1	Conn Mod Jack 6-6 R/A PCB 50AU	Tyco® Electronics/Amp	555165-1
1	L2	Inductor Shield PWR 15UH SMD	Coiltronics/Div of Cooper/Bussmann	DR74-150-R
1	Q1	MOSFET N-CH 60V 2.5A SOT-23-6	Zetex Inc	ZXMN6A08E6TA
1	Q2	MOSFET N-CH 20V 6A 8-MSOP	Zetex Inc	ZXMN2A02X8TA
3	R1, R2, R3	Res 30.1K Ohm 1/10W 1% 0603 SMD	Panasonic - ECG	ERJ-3EKF3012V
1	R4	RES 14.7K Ohm 1/10W 1% 0603 SMD	Panasonic - ECG	ERJ-3EKF1472V
4	R5, R6, R9, R16	Res 2.00K Ohm 1/10W 1% 0603 SMD	Panasonic - ECG	ERJ-3EKF2001V
2	R7,R8	Res 0.22 Ohm 1/4W 1% 1206 SMD	Panasonic - ECG	ERJ-8RQFR22V
1	R10	Res 10.0 Ohm 1/10W 1% 0603 SMD	Panasonic - ECG	ERJ-3EKF10R0V
3	R11, R12, R15	DNP	—	—
1	R13	Res 8.06K Ohm 1/10W 1% 0603 SMD	Panasonic - ECG	ERJ-3EKF8061V
1	R14	Res 78.7K Ohm 1/10W 1% 0603 SMD	Panasonic - ECG	ERJ-3EKF7872V
1	R17	Res 47.5K Ohm 1/10W 1% 0603 SMD	Panasonic - ECG	ERJ-3EKF4752V
1	R18	Res 4.99K Ohm 1/10W 1% 0603 SMD	Panasonic - ECG	ERJ-3EKF4991V
1	SW1	Switch Tact 6MM 260GF SMT	E-Switch	TL3301NF260QG

**Note 1:** The components listed in this Bill of Materials are representative of the PCB assembly. The released BOM used in manufacturing uses all RoHS-compliant components.

## MCP1630 Automotive Input Triple Output Converter Demo Board User's Guide

---

**TABLE B-1: BILL OF MATERIALS (BOM) (CONTINUED)**

Qty	Reference	Description	Manufacturer	Part Number
8	TP1,TP2,TP3,TP4,TP5,TP6,TP7,TP8	PC Test point compact SMT	Keystone Electronics®	5016
1	T1	Inductor / Transformer 5.7uH SMD	Coiltronics/Div of Cooper/Bussmann	VP2-0116-R
1	U1	IC PWM HS MCU-Adaptable 8MSOP	Microchip Technology Inc	MCP1630-E/MS
1	U2	IC Regulator Ultra -LO 5V 8-MSOP	National Semiconductor®	LM2936MM-5.0
1	U3	IC MCU Flash 2KX14 8SOIC	Microchip Technology Inc	PIC12F683-I/SNG

**Note 1:** The components listed in this Bill of Materials are representative of the PCB assembly. The released BOM used in manufacturing uses all RoHS-compliant components.

**Appendix C. Demo Board Firmware**

**C.1 DEVICE FIRMWARE**

For the latest version of the MCP1630 Automotive Input Triple Output Converter Demo Board firmware, visit our web site at [www.microchip.com](http://www.microchip.com).

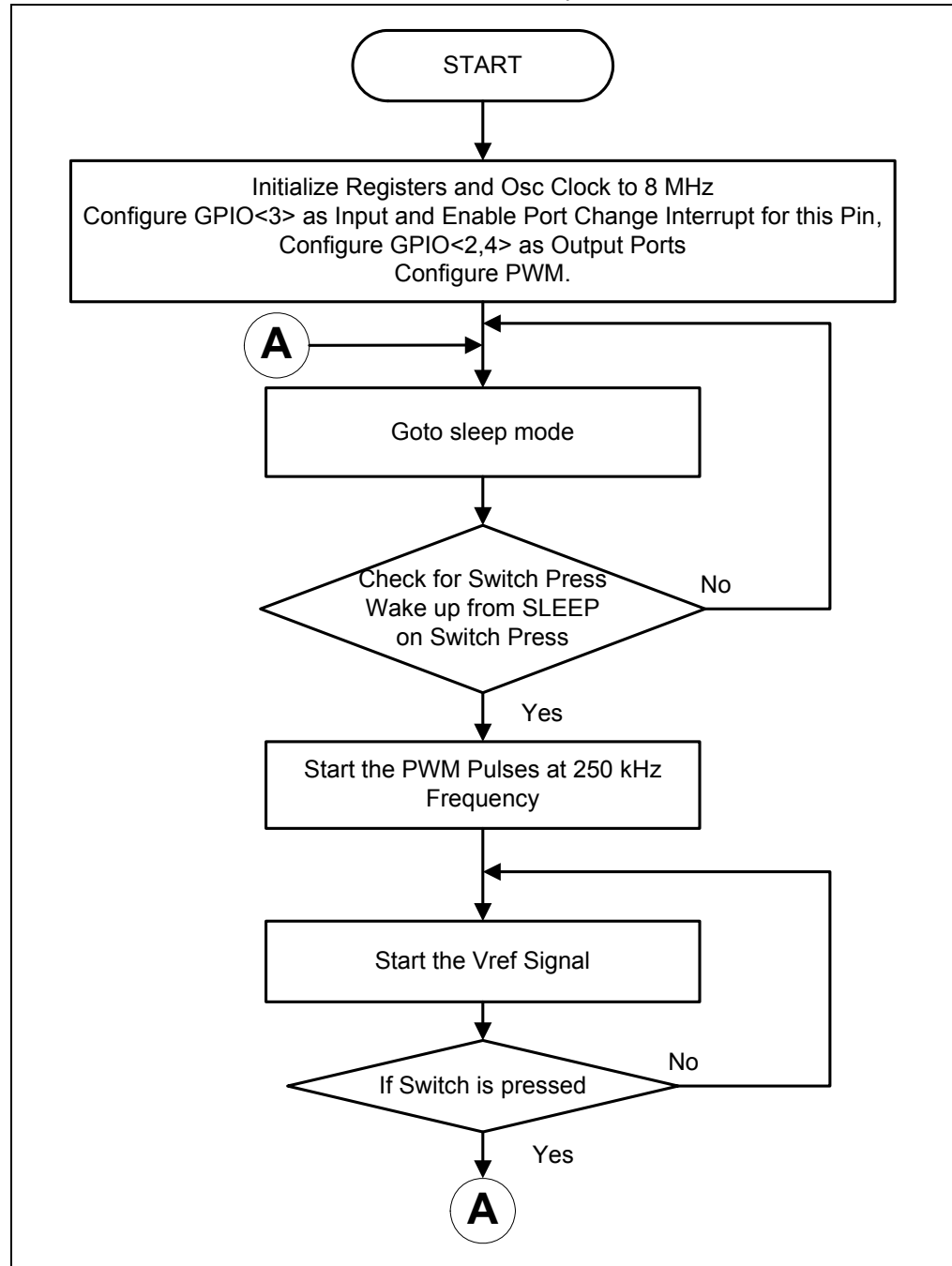

**FIGURE C-1:** Firmware Flowchart.



**MICROCHIP**

## WORLDWIDE SALES AND SERVICE

### AMERICAS

#### Corporate Office

2355 West Chandler Blvd.  
Chandler, AZ 85224-6199  
Tel: 480-792-7200  
Fax: 480-792-7277  
Technical Support:  
<http://support.microchip.com>  
Web Address:  
[www.microchip.com](http://www.microchip.com)

#### Atlanta

Alpharetta, GA  
Tel: 770-640-0034  
Fax: 770-640-0307

#### Boston

Westborough, MA  
Tel: 774-760-0087  
Fax: 774-760-0088

#### Chicago

Itasca, IL  
Tel: 630-285-0071  
Fax: 630-285-0075

#### Dallas

Addison, TX  
Tel: 972-818-7423  
Fax: 972-818-2924

#### Detroit

Farmington Hills, MI  
Tel: 248-538-2250  
Fax: 248-538-2260

#### Kokomo

Kokomo, IN  
Tel: 765-864-8360  
Fax: 765-864-8387

#### Los Angeles

Mission Viejo, CA  
Tel: 949-462-9523  
Fax: 949-462-9608

#### Santa Clara

Santa Clara, CA  
Tel: 408-961-6444  
Fax: 408-961-6445

#### Toronto

Mississauga, Ontario,  
Canada  
Tel: 905-673-0699  
Fax: 905-673-6509

### ASIA/PACIFIC

#### Asia Pacific Office

Suites 3707-14, 37th Floor  
Tower 6, The Gateway  
Harbour City, Kowloon  
Hong Kong  
Tel: 852-2401-1200  
Fax: 852-2401-3431

#### Australia - Sydney

Tel: 61-2-9868-6733  
Fax: 61-2-9868-6755

#### China - Beijing

Tel: 86-10-8528-2100  
Fax: 86-10-8528-2104

#### China - Chengdu

Tel: 86-28-8665-5511  
Fax: 86-28-8665-7889

#### China - Fuzhou

Tel: 86-591-8750-3506  
Fax: 86-591-8750-3521

#### China - Hong Kong SAR

Tel: 852-2401-1200  
Fax: 852-2401-3431

#### China - Qingdao

Tel: 86-532-8502-7355  
Fax: 86-532-8502-7205

#### China - Shanghai

Tel: 86-21-5407-5533  
Fax: 86-21-5407-5066

#### China - Shenyang

Tel: 86-24-2334-2829  
Fax: 86-24-2334-2393

#### China - Shenzhen

Tel: 86-755-8203-2660  
Fax: 86-755-8203-1760

#### China - Shunde

Tel: 86-757-2839-5507  
Fax: 86-757-2839-5571

#### China - Wuhan

Tel: 86-27-5980-5300  
Fax: 86-27-5980-5118

#### China - Xian

Tel: 86-29-8833-7250  
Fax: 86-29-8833-7256

### ASIA/PACIFIC

#### India - Bangalore

Tel: 91-80-4182-8400  
Fax: 91-80-4182-8422

#### India - New Delhi

Tel: 91-11-4160-8631  
Fax: 91-11-4160-8632

#### India - Pune

Tel: 91-20-2566-1512  
Fax: 91-20-2566-1513

#### Japan - Yokohama

Tel: 81-45-471- 6166  
Fax: 81-45-471-6122

#### Korea - Gumi

Tel: 82-54-473-4301  
Fax: 82-54-473-4302

#### Korea - Seoul

Tel: 82-2-554-7200  
Fax: 82-2-558-5932 or  
82-2-558-5934

#### Malaysia - Penang

Tel: 60-4-646-8870  
Fax: 60-4-646-5086

#### Philippines - Manila

Tel: 63-2-634-9065  
Fax: 63-2-634-9069

#### Singapore

Tel: 65-6334-8870  
Fax: 65-6334-8850

#### Taiwan - Hsin Chu

Tel: 886-3-572-9526  
Fax: 886-3-572-6459

#### Taiwan - Kaohsiung

Tel: 886-7-536-4818  
Fax: 886-7-536-4803

#### Taiwan - Taipei

Tel: 886-2-2500-6610  
Fax: 886-2-2508-0102

#### Thailand - Bangkok

Tel: 66-2-694-1351  
Fax: 66-2-694-1350

### EUROPE

#### Austria - Wels

Tel: 43-7242-2244-3910  
Fax: 43-7242-2244-393

#### Denmark - Copenhagen

Tel: 45-4450-2828  
Fax: 45-4485-2829

#### France - Paris

Tel: 33-1-69-53-63-20  
Fax: 33-1-69-30-90-79

#### Germany - Munich

Tel: 49-89-627-144-0  
Fax: 49-89-627-144-44

#### Italy - Milan

Tel: 39-0331-742611  
Fax: 39-0331-466781

#### Netherlands - Drunen

Tel: 31-416-690399  
Fax: 31-416-690340

#### Spain - Madrid

Tel: 34-91-708-08-90  
Fax: 34-91-708-08-91

#### UK - Wokingham

Tel: 44-118-921-5869  
Fax: 44-118-921-5820

08/29/06



## X-ON Electronics

Largest Supplier of Electrical and Electronic Components

*Click to view similar products for [Power Management IC Development Tools](#) category:*

*Click to view products by [Microchip](#) manufacturer:*

Other Similar products are found below :

[EVB-EP5348UI](#) [MIC23451-AAAYFL EV](#) [MIC5281YMME EV](#) [124352-HMC860LP3E](#) [DA9063-EVAL](#) [ADP122-3.3-EVALZ](#) [ADP130-0.8-EVALZ](#) [ADP130-1.8-EVALZ](#) [ADP1740-1.5-EVALZ](#) [ADP1870-0.3-EVALZ](#) [ADP1874-0.3-EVALZ](#) [ADP199CB-EVALZ](#) [ADP2102-1.25-EVALZ](#) [ADP2102-1.875EVALZ](#) [ADP2102-1.8-EVALZ](#) [ADP2102-2-EVALZ](#) [ADP2102-3-EVALZ](#) [ADP2102-4-EVALZ](#) [AS3606-DB](#) [BQ25010EVM](#) [BQ3055EVM](#) [ISLUSBI2CKIT1Z](#) [LP38512TS-1.8EV](#) [EVAL-ADM1186-1MBZ](#) [EVAL-ADM1186-2MBZ](#) [ADP122UJZ-REDYKIT](#) [ADP166Z-REDYKIT](#) [ADP170-1.8-EVALZ](#) [ADP171-EVALZ](#) [ADP1853-EVALZ](#) [ADP1873-0.3-EVALZ](#) [ADP198CP-EVALZ](#) [ADP2102-1.0-EVALZ](#) [ADP2102-1-EVALZ](#) [ADP2107-1.8-EVALZ](#) [ADP5020CP-EVALZ](#) [CC-ACC-DBMX-51](#) [ATPL230A-EK](#) [MIC23250-S4YMT EV](#) [MIC26603YJL EV](#) [MIC33050-SYHL EV](#) [TPS60100EVM-131](#) [TPS65010EVM-230](#) [TPS71933-28EVM-213](#) [TPS72728YFFEVM-407](#) [TPS79318YEQEVM](#) [UCC28810EVM-002](#) [XILINXPWR-083](#) [LMR22007YMINI-EVM](#) [LP38501ATJ-EV](#)