

100 mA High-Voltage Automotive LDO

Features

- AEC-Q100 with Grade 0 and PPAP Capable
- Wide Input Voltage Range: 4.5V to 55V
 - Up to 70V transient
 - Under Voltage Lock Out (UVLO): 2.7V typical
- Extended Operating Temperature Range: -40°C to +150°C
- Standard Output Regulated Voltages (V_R): 3.3V and 5.0V ([Note 1](#))
 - Tolerance $\pm 2.0\%$ typical
- Low Quiescent Supply Current: 25 μA typical
- Low Shutdown Quiescent Supply Current: 2 μA typical
- Output Current Capability: 100 mA typical
 - Short Circuit Current Foldback Protection
 - Thermal Shutdown Protection: 175°C
- Stable with Ceramic Output Capacitor: 2.2 μF
- High PSRR:
 - 80 dB @ 100 Hz typical
 - 55 dB @ 100 kHz typical
- Available in the following packages:
 - 3-Lead SOT-223 (MCP1792)
 - 3-Lead SOT-23A (MCP1792)
 - 5-Lead SOT-223 (MCP1793)
 - 5-Lead SOT-23 (MCP1793)

Description

The MCP1792/3 family devices are high-voltage, low dropout (LDO) regulators, capable of generating 100 mA output current. The input voltage range of 4.5V to 55V makes it suitable in 12V to 48V power rails and in high-voltage battery packs.

A low UVLO at shutdown of 2.4V makes it adequate for cold cranking conditions in automotive applications.

The MCP1792/3 comes in two standard fixed output voltage versions: 3.3V and 5.0V. The regulator output is stable with 2.2 μF ceramic capacitors. The device is protected from short-circuit events by the current foldback function and from overheating by means of thermal shutdown protection.

The MCP1792 is the 3-lead version of the MCP1792/3 device family and the MCP1793 is the 5-lead version, which offers shutdown functionality (SHDN pin). While in shutdown, the quiescent current drops to 2 μA , allowing for lower, overall power consumption. The device itself has a ground current of 100 μA typical, while delivering maximum output current of 100 mA.

Note 1: For other voltage options, please contact your local sales office.

Applications

- Automotive Electronics
- Microcontroller Biasing
- High-Voltage Battery Packs for Power Tools, ebikes, etc
- Smoke Detectors and other Alarm Sensors

Typical Application

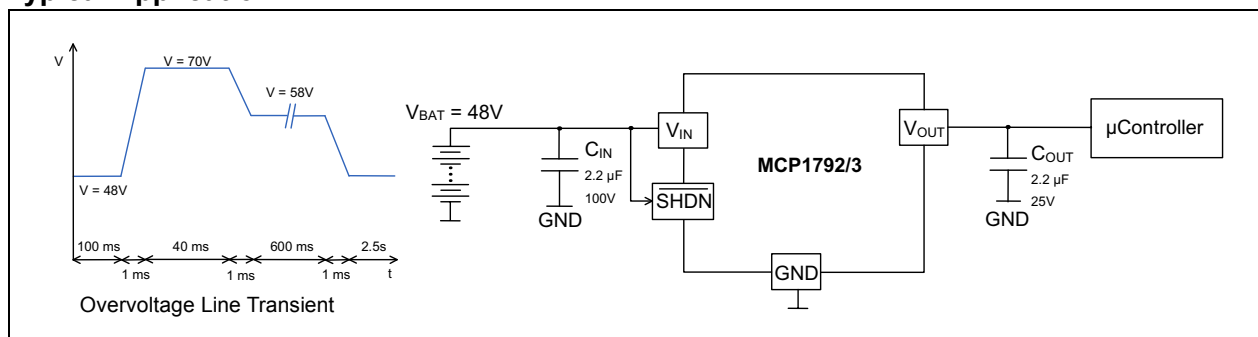

Package Types

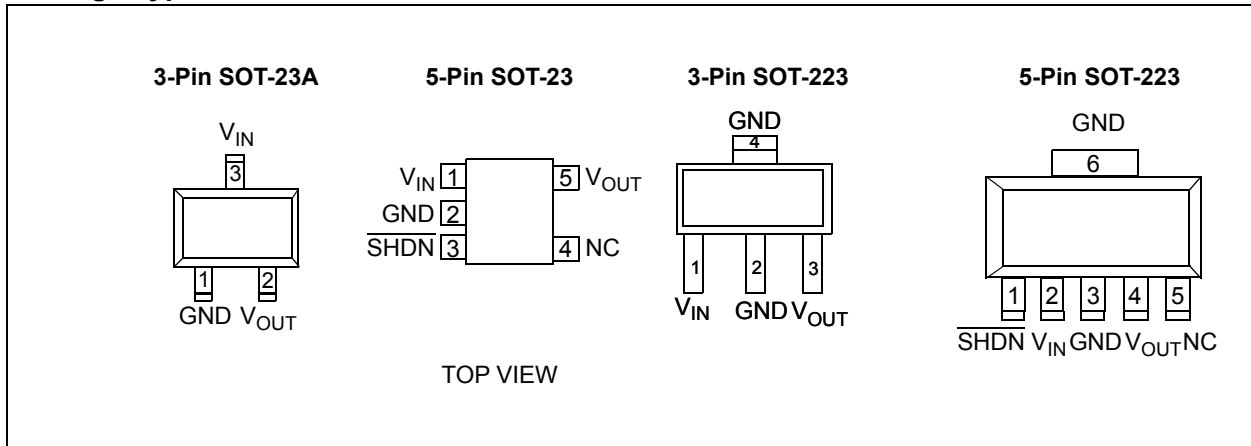

1.0 ELECTRICAL CHARACTERISTICS

Absolute Maximum Ratings †

Input Voltage	+70.0V
Maximum Voltage on V_{IN} , \overline{SHDN}	(GND - 0.3V) to ($V_{IN}+0.3V$)
Maximum Voltage on V_{OUT-}	(GND - 0.3V) to 5.5V
Output Short-Circuit Duration	Unlimited (Note 2)
Storage Temperature	-55°C to +175°C
Maximum Junction Temperature, T_J	+175°C
Operating Junction Temperature, T_J	-40°C to +150°C
ESD protection on all pins:	
HBM	≥ 2 kV
CDM	≥ 750V
MM	≥ 200V

† **Note:** Stresses above those listed under “Absolute Maximum Ratings” may cause permanent damage to the device. This is a stress rating only and functional operation of the device at those or any other conditions above those indicated in the operational listings of this specification is not intended. Exposure to maximum rating conditions for extended periods may affect device reliability.

AC/DC CHARACTERISTICS

Electrical Specifications: Unless otherwise noted, $V_{IN} = V_R + 1.2V$ (**Note 1**), $I_{OUT} = 1$ mA, $C_{IN} = C_{OUT} = 2.2$ μF ceramic (X7R), $T_A = +25^\circ C$, $\overline{SHDN} > 2.4V$. **Boldface** type applies for ambient temperatures T_A of -40°C to +150°C (**Note 2**).

Parameters	Sym.	Min.	Typ.	Max.	Units	Conditions
Input Operating Voltage	V_{IN}	4.5	—	55	V	
Output Voltage Range	V_{OUT}	$V_R-2\%$	V_R	$V_R+2\%$		T_A of -40°C to +85°C
		$V_R-3\%$	V_R	$V_R+3\%$		T_A of -40°C to +150°C
Input Quiescent Current	I_Q	—	25	45	μA	$I_{OUT} = 0A$
Input Quiescent Current for SHDN Mode	$I_{\overline{SHDN}}$	—	2	12	μA	$\overline{SHDN} = GND$, $V_{IN} = 55V$
Ground Current	I_{GND}	—	100	150	μA	$I_{OUT} = 100$ mA
		—	25	—		$I_{OUT} = 1$ mA
Maximum Continuous Output Current	I_{OUT}	100	—	—	mA	(Note 2)
Foldback Current Corner	I_{OUT_SC}	—	230	370	mA	$V_{IN} \leq 55V$ (Note 5)
Foldback Current	$I_{FOLDBACK}$	—	10	—	mA	$V_{OUT} \sim 0V$, $R_{LOAD} \geq 0.1\Omega$, $V_{IN} \leq 55V$, (Note 5)

Note 1: V_R is the nominal output voltage. The minimum input voltage is $V_{IN} = V_R + 1.2V$ or $V_{IN} = V_{IN_MIN}$, whichever is greater.

- The maximum allowable power dissipation is a function of ambient temperature, the maximum allowable junction temperature and the thermal resistance from junction to air (i.e., T_A , T_J , θ_{JA}). See the [Temperature Specifications](#) table and [Section 5.0 “Application Information”](#). Exceeding the maximum allowable power dissipation will cause the device operating junction temperature to exceed the maximum 150°C rating. Sustained junction temperatures above 150°C can impact the device reliability.
- Dropout voltage is defined as the input to output voltage differential at which the output voltage drops 2% below its nominal value that was measured with an input voltage of $V_{IN} = V_R + 1.2V$.
- PSRR measurement is carried out with $C_{IN} = 0$ μF , $V_{IN} = 7V$, $I_{OUT} = 10$ mA, $V_{INAC} = 0.4 V_{pkpk}$.
- Not production tested.

AC/DC CHARACTERISTICS (CONTINUED)

Electrical Specifications: Unless otherwise noted, $V_{IN} = V_R + 1.2V$ (**Note 1**), $I_{OUT} = 1\text{ mA}$, $C_{IN} = C_{OUT} = 2.2\ \mu\text{F}$ ceramic (X7R), $T_A = +25^\circ\text{C}$, $\overline{\text{SHDN}} > 2.4V$. **Boldface** type applies for ambient temperatures T_A of -40°C to $+150^\circ\text{C}$ (**Note 2**).

Parameters	Sym.	Min.	Typ.	Max.	Units	Conditions
Line Regulation	$\frac{\Delta V_{OUT}}{V_{OUT} \times \Delta V_{IN}}$		± 0.0002	± 0.05	%/V	$4.5V < V_{IN} < 55V$, $6.2V < V_{IN} < 55V$
Load Regulation	$\Delta V_{OUT}/V_{OUT}$	-1	0.2	+1	%	$I_{OUT} = 1\text{ mA to }100\text{ mA}$, T_A of -40°C to $+85^\circ\text{C}$
		-2	0.2	+2		$I_{OUT} = 1\text{ mA to }100\text{ mA}$, T_A of -40°C to $+150^\circ\text{C}$
Dropout Voltage	$V_{DROPOUT}$	—	250	400	mV	T_A of -40°C to $+85^\circ\text{C}$, $I_{OUT} = 100\text{ mA}$
		—	250	1200		T_A of -40°C to $+150^\circ\text{C}$, $I_{OUT} = 100\text{ mA}$ (Note 3)
Input Voltage to Turn On Output	V_{UVLO_High}		2.7		V	$V_R = 3.3V$, $V_R = 5.0V$, rising V_{IN} , $V_{IN} = 0$ to V_{IN_MIN}
Input Voltage to Turn Off Output	V_{UVLO_Low}		2.4		V	$V_R = 3.3V$, $V_R = 5.0V$, failing V_{IN} , $V_{IN} = V_{IN_MIN}$ to 0
Shutdown Input						
Logic High Input	V_{SHDN_HIGH}	2.4	—	V_{IN}	V	
Logic Low Input	V_{SHDN_LOW}	0	—	0.8	V	
Shutdown Input Leakage Current	$\overline{\text{SHDN}}_{ILK}$	—	0.2	0.4	μA	$\overline{\text{SHDN}} = \text{GND}$, or $\overline{\text{SHDN}} = 6.2V$
AC Performance						
Output Voltage Delay Time	T_{DELAY}	—	800	1200	μs	$V_{IN} = 0$ to $6.2V$ $V_{OUT} = \text{GND}$ to 10% of V_R , $R_{LOAD} = 50\ \Omega$ (Note 5)
Output Rise Time	T_{RISE}		400		μs	$V_{IN} = 0$ to $6.2V$ $V_{OUT} = 10\%$ to 90% of V_R , $R_{LOAD} = 50\ \Omega$ (Note 5)
Output Noise	e_N	—	400	—	μV_{rms}	$f = 10\text{ Hz to }100\text{ kHz}$, $V_R = 3.3V$, $I_{OUT} = 10\text{ mA}$ (Note 5)
Power Supply Ripple Rejection Ratio	PSRR	—	80	—	dB	$f = 100\text{ Hz}$ (Note 4 , Note 5)
			55			$f = 100\text{ kHz}$ (Note 4 , Note 5)

Note 1: V_R is the nominal output voltage. The minimum input voltage is $V_{IN} = V_R + 1.2V$ or $V_{IN} = V_{IN_MIN}$, whichever is greater.

- The maximum allowable power dissipation is a function of ambient temperature, the maximum allowable junction temperature and the thermal resistance from junction to air (i.e., T_A , T_J , θ_{JA}). See the [Temperature Specifications](#) table and [Section 5.0 "Application Information"](#). Exceeding the maximum allowable power dissipation will cause the device operating junction temperature to exceed the maximum 150°C rating. Sustained junction temperatures above 150°C can impact the device reliability.
- Dropout voltage is defined as the input to output voltage differential at which the output voltage drops 2% below its nominal value that was measured with an input voltage of $V_{IN} = V_R + 1.2V$.
- PSRR measurement is carried out with $C_{IN} = 0\ \mu\text{F}$, $V_{IN} = 7V$, $I_{OUT} = 10\text{ mA}$, $V_{INAC} = 0.4\ V_{pkpk}$.
- Not production tested.

TEMPERATURE SPECIFICATIONS

Parameters	Sym.	Min.	Typ.	Max.	Units	Conditions
Temperature Ranges						
Thermal Shutdown	T_{SD}		175	181	°C	Rising Temperature
Thermal Shutdown Hysteresis	ΔT_{SD}	—	15		°C	Falling Temperature
Thermal Package Resistances						
Thermal Resistance, SOT-23A-3LD	θ_{JA}	—	147	—	°C/W	JEDEC® standard 4-layer FR4 board with 1 oz. copper
	θ_{JC}	—	115	—		
Thermal Resistance, SOT23-5LD	θ_{JA}	—	165	—		
	θ_{JC}	—	96	—		
Thermal Resistance, SOT-223-3LD	θ_{JA}	—	70	—		
	θ_{JC}	—	60	—		
Thermal Resistance, SOT-223-5LD	θ_{JA}	—	75	—		
	θ_{JC}	—	60	—		

2.0 TYPICAL PERFORMANCE CURVES

Note: The graphs and tables provided following this note are a statistical summary based on a limited number of samples and are provided for informational purposes only. The performance characteristics listed herein are not tested or guaranteed. In some graphs or tables, the data presented may be outside the specified operating range (e.g., outside specified power supply range) and therefore outside the warranted range.

Note: Unless otherwise indicated, $C_{IN} = C_{OUT} = 2.2 \mu\text{F}$ ceramic (X7R), $I_{OUT} = 1 \text{ mA}$, $T_A = +25^\circ\text{C}$, $V_{IN} = V_R + 1.2\text{V}$, $\text{SHDN} = 1 \text{ M}\Omega$ pull-up to V_{IN} .

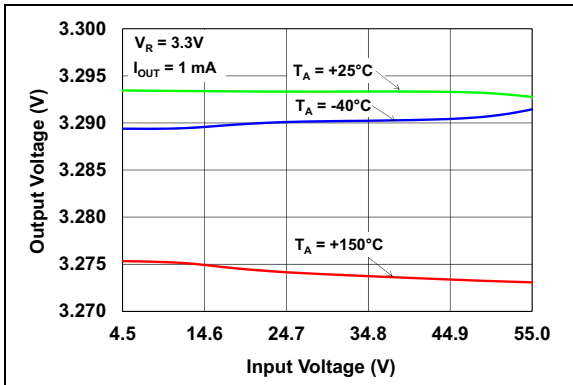

FIGURE 2-1: Output Voltage vs. Input Voltage ($V_R = 3.3\text{V}$).

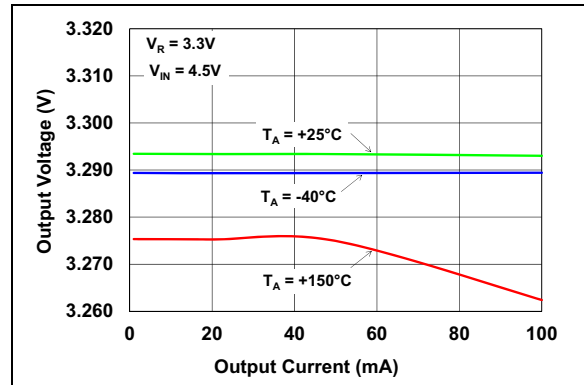

FIGURE 2-4: Output Voltage vs. Output Current ($V_R = 3.3\text{V}$).

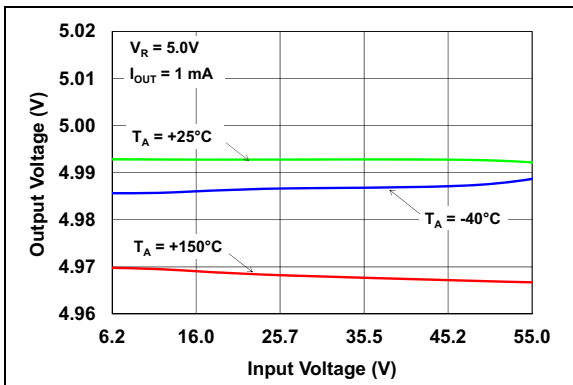

FIGURE 2-2: Output Voltage vs. Input Voltage ($V_R = 5.0\text{V}$).

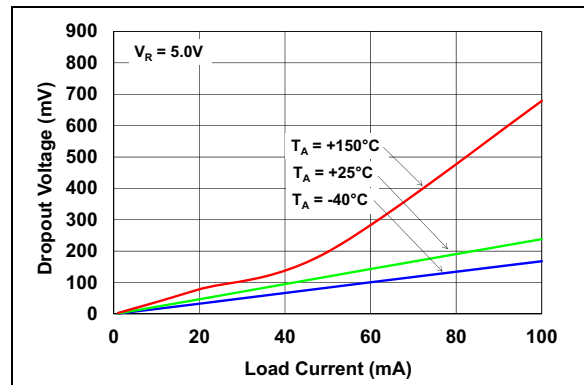

FIGURE 2-5: Dropout Voltage vs. Load Current.

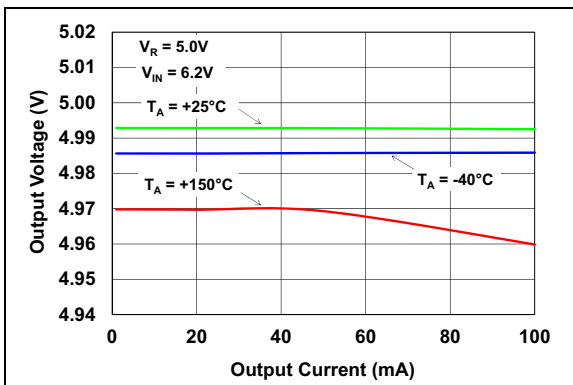

FIGURE 2-3: Output Voltage vs. Output Current ($V_R = 5.0\text{V}$).

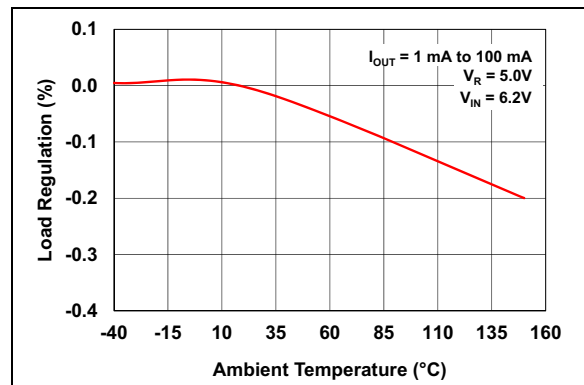

FIGURE 2-6: Load Regulation vs. Temperature ($V_R = 5.0\text{V}$).

Note: Unless otherwise indicated, $C_{IN} = C_{OUT} = 2.2 \mu\text{F}$ ceramic (X7R), $I_{OUT} = 1 \text{ mA}$, $T_A = +25^\circ\text{C}$, $V_{IN} = V_R + 1.2\text{V}$, $\text{SHDN} = 1 \text{ M}\Omega$ pull-up to V_{IN} .

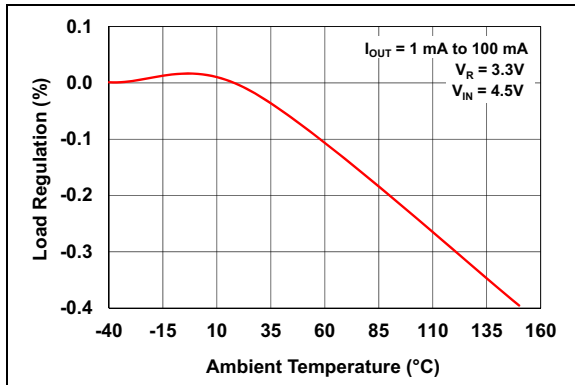

FIGURE 2-7: Load Regulation vs. Temperature ($V_R = 3.3\text{V}$).

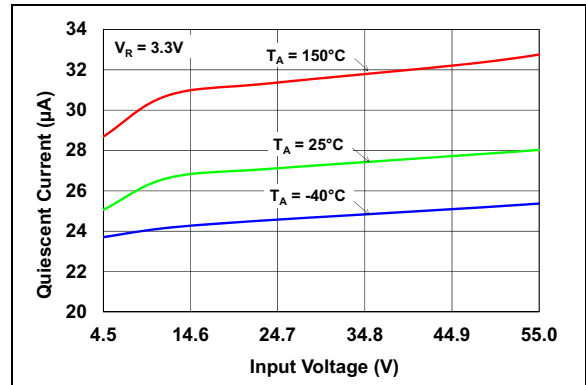

FIGURE 2-10: Quiescent Current vs. Input Voltage ($V_R = 3.3\text{V}$).

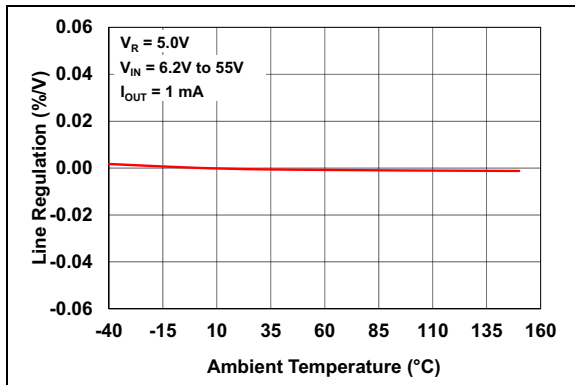

FIGURE 2-8: Line Regulation vs. Ambient Temperature ($V_R = 5.0\text{V}$).

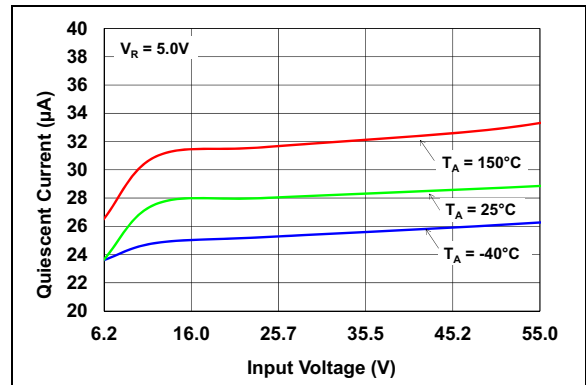

FIGURE 2-11: Quiescent Current vs. Input Voltage ($V_R = 5.0\text{V}$).

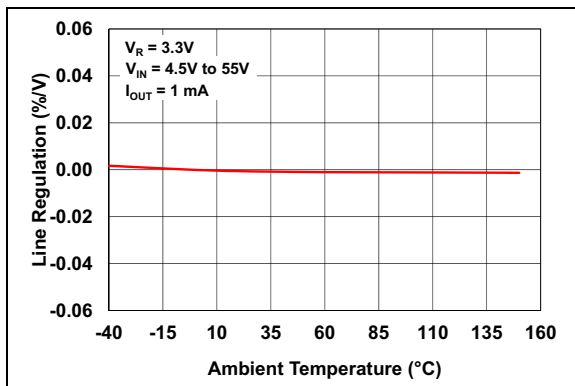

FIGURE 2-9: Line Regulation vs. Ambient Temperature ($V_R = 3.3\text{V}$).

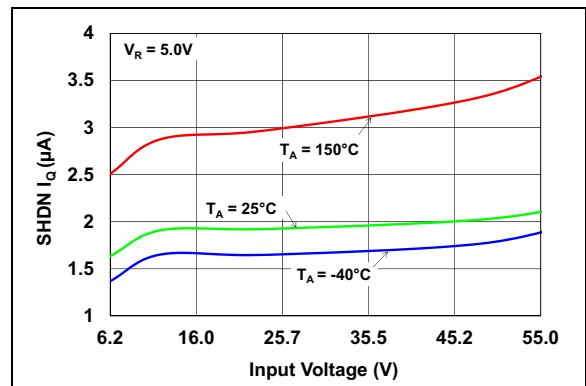

FIGURE 2-12: Shutdown Quiescent Current vs. Input Voltage ($V_R = 5.0\text{V}$).

Note: Unless otherwise indicated, $C_{IN} = C_{OUT} = 2.2 \mu\text{F}$ ceramic (X7R), $I_{OUT} = 1 \text{ mA}$, $T_A = +25^\circ\text{C}$, $V_{IN} = V_R + 1.2\text{V}$, $\text{SHDN} = 1 \text{ M}\Omega$ pull-up to V_{IN} .

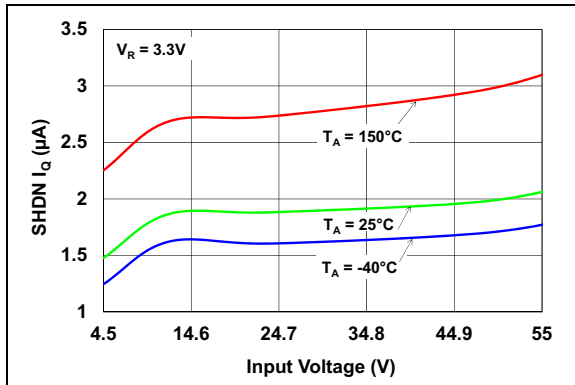

FIGURE 2-13: Shutdown Quiescent Current vs. Input Voltage ($V_R = 3.3\text{V}$).

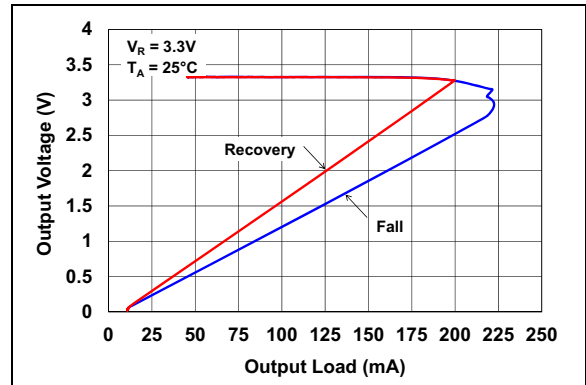

FIGURE 2-16: Current Foldback ($V_R = 3.3\text{V}$).

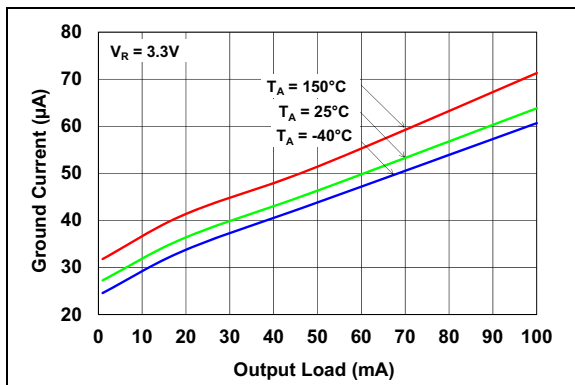

FIGURE 2-14: Ground Current vs. Output Current ($V_R = 3.3\text{V}$).

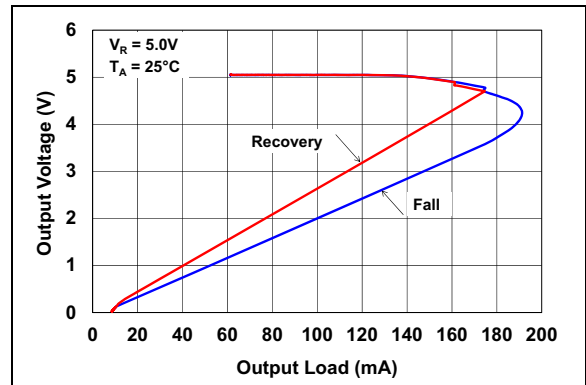

FIGURE 2-17: Current Foldback ($V_R = 5.0\text{V}$).

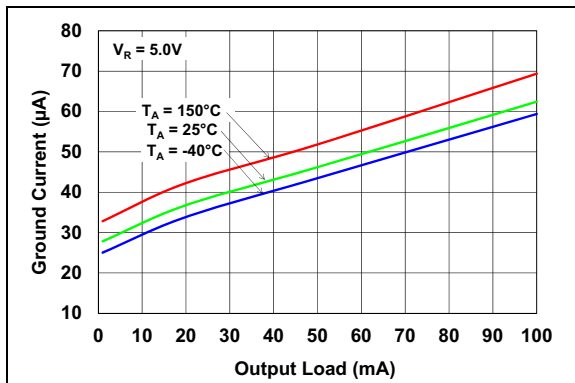

FIGURE 2-15: Ground Current vs. Output Current ($V_R = 5.0\text{V}$).

Note: Unless otherwise indicated, $C_{IN} = C_{OUT} = 2.2 \mu\text{F}$ ceramic (X7R), $I_{OUT} = 1 \text{ mA}$, $T_A = +25^\circ\text{C}$, $V_{IN} = V_R + 1.2\text{V}$, $\text{SHDN} = 1 \text{ M}\Omega$ pull-up to V_{IN} .

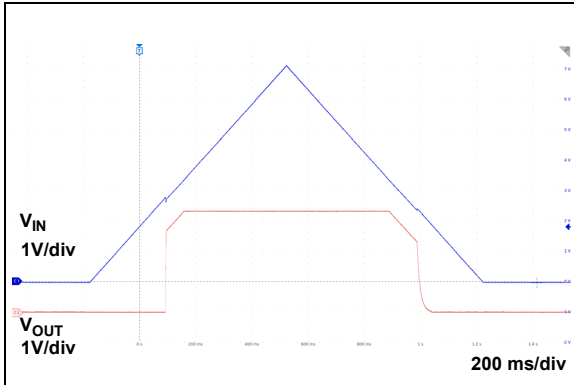

FIGURE 2-18: UVLO ($V_R = 3.3\text{V}$).

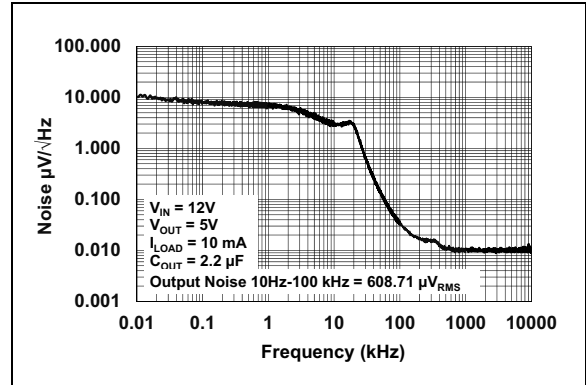

FIGURE 2-21: Noise vs. Frequency ($V_R = 5.0\text{V}$).

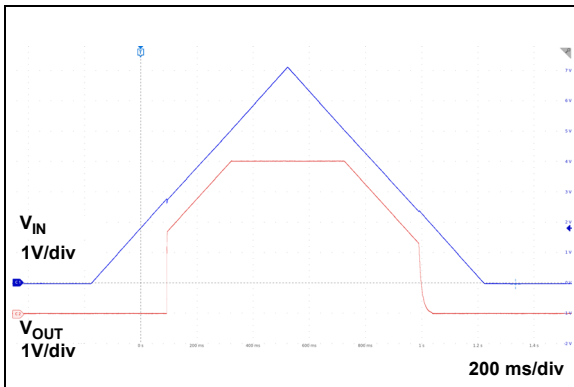

FIGURE 2-19: UVLO ($V_R = 5\text{V}$).

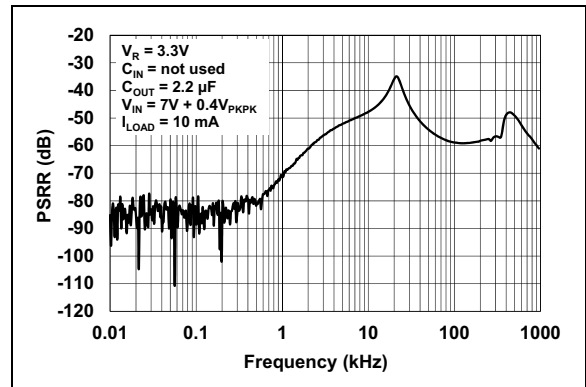

FIGURE 2-22: Power Supply Ripple Rejection vs. Frequency ($V_R = 3.3\text{V}$).

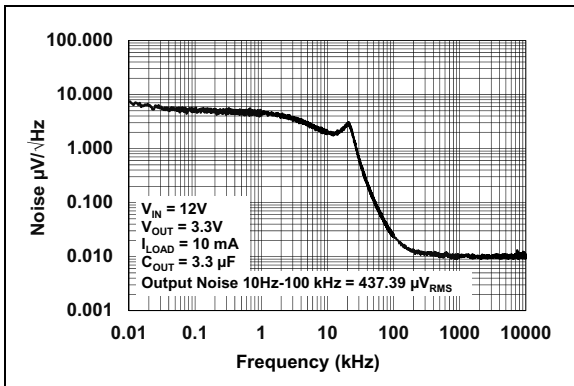

FIGURE 2-20: Noise vs. Frequency ($V_R = 3.3\text{V}$).

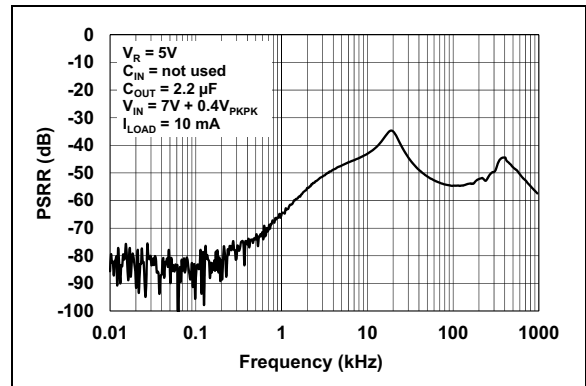

FIGURE 2-23: Power Supply Ripple Rejection vs. Frequency ($V_R = 5.0\text{V}$).

Note: Unless otherwise indicated, $C_{IN} = C_{OUT} = 2.2 \mu\text{F}$ ceramic (X7R), $I_{OUT} = 1 \text{ mA}$, $T_A = +25^\circ\text{C}$, $V_{IN} = V_R + 1.2\text{V}$, $\text{SHDN} = 1 \text{ M}\Omega$ pull-up to V_{IN} .

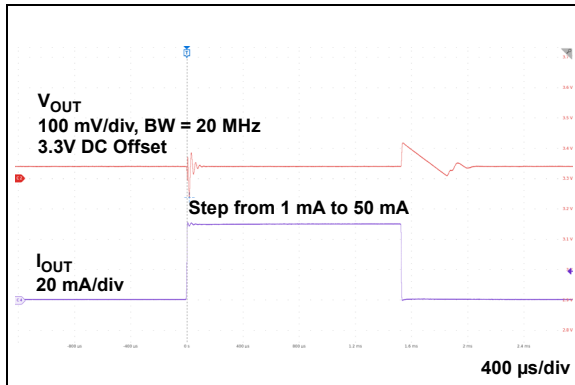

FIGURE 2-24: Dynamic Load Step ($V_R = 3.3\text{V}$).

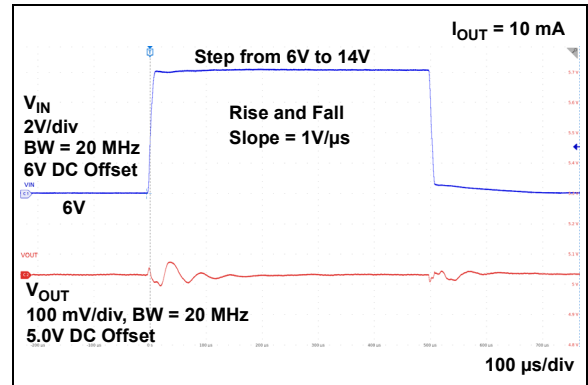

FIGURE 2-27: Dynamic Line Step ($V_R = 5.0\text{V}$).

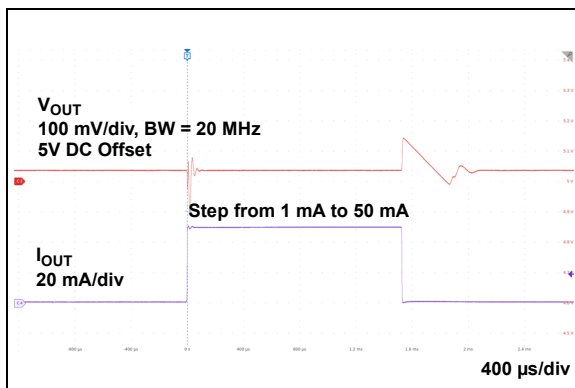

FIGURE 2-25: Dynamic Load Step ($V_R = 5.0\text{V}$).

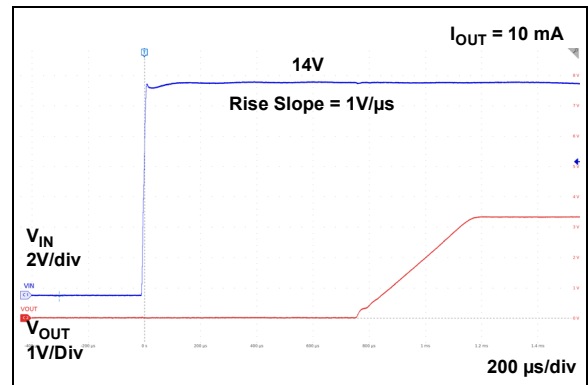

FIGURE 2-28: Start-up From V_{IN} (0V to 14V , $V_R = 3.3\text{V}$).

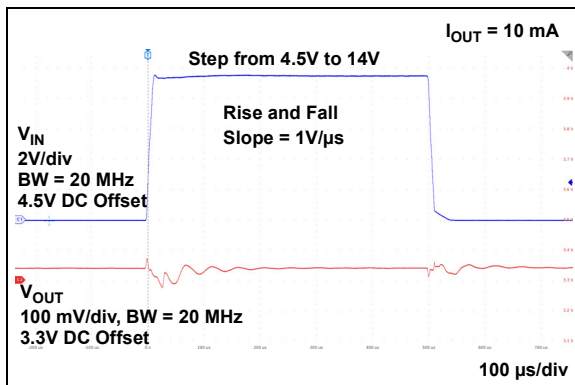

FIGURE 2-26: Dynamic Line Step ($V_R = 3.3\text{V}$).

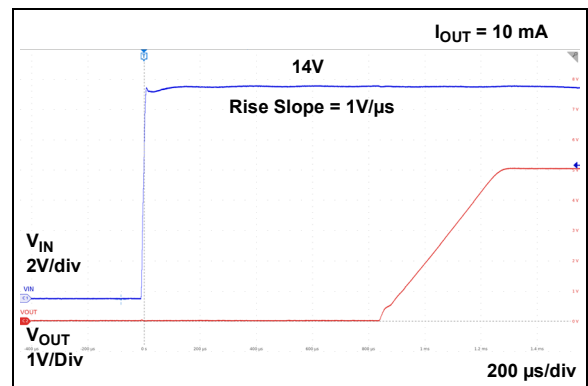

FIGURE 2-29: Start-up From V_{IN} (0V to 14V , $V_R = 5.0\text{V}$).

Note: Unless otherwise indicated, $C_{IN} = C_{OUT} = 2.2 \mu\text{F}$ ceramic (X7R), $I_{OUT} = 1 \text{ mA}$, $T_A = +25^\circ\text{C}$, $V_{IN} = V_R + 1.2\text{V}$, $\text{SHDN} = 1 \text{ M}\Omega$ pull-up to V_{IN} .

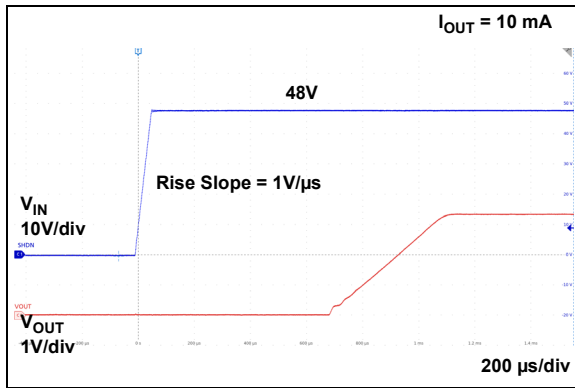

FIGURE 2-30: Start-up From V_{IN} (0V to 48V , $V_R = 3.3\text{V}$).

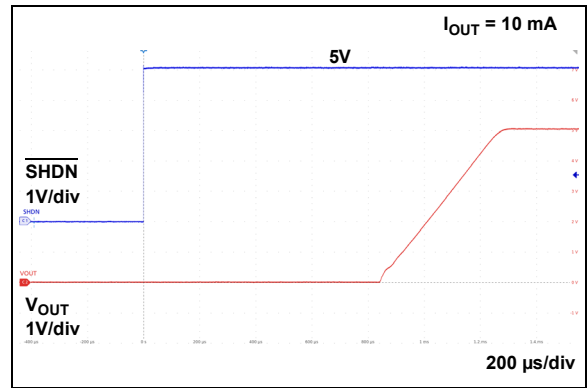

FIGURE 2-33: Start-up From $\overline{\text{SHDN}}$ ($V_R = 5.0\text{V}$).

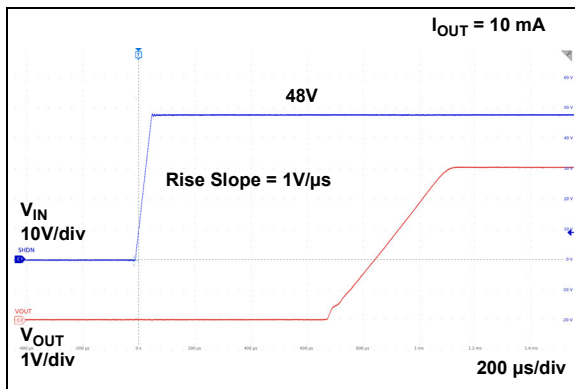

FIGURE 2-31: Start-up From V_{IN} (0V to 48V , $V_R = 5\text{V}$).

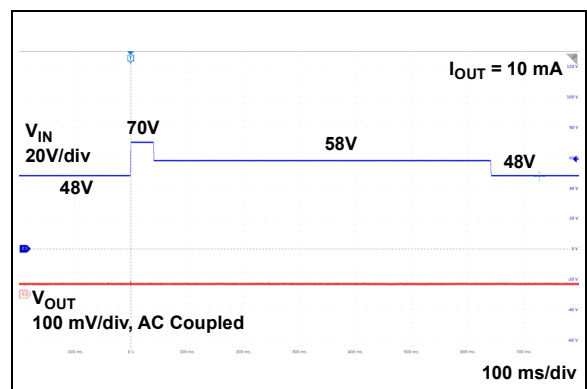

FIGURE 2-34: Overvoltage Line Transient Response ($V_R = 5\text{V}$).

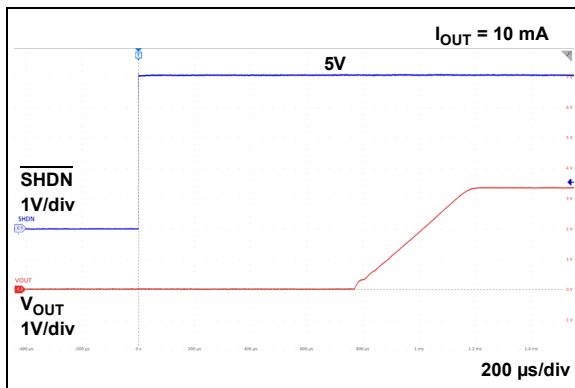

FIGURE 2-32: Start-up From $\overline{\text{SHDN}}$ ($V_R = 3.3\text{V}$).

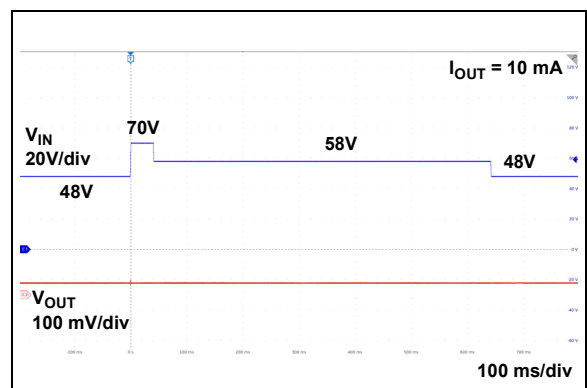

FIGURE 2-35: Overvoltage Line Transient Response ($V_R = 3.3\text{V}$).

3.0 PIN DESCRIPTION

The descriptions of the pins are listed in [Table 3-1](#).

TABLE 3-1: PIN FUNCTION TABLE

SOT 23A-3	SOT 23-5	SOT 223-3	SOT 223-5	Symbol	Description
1	2	2	3	GND	Ground
2	5	3	4	V _{OUT}	Regulated Output Voltage V _R
3	1	1	2	V _{IN}	Input Voltage Supply
—	4	—	5	NC	Not connected pins (should either be left floating or connected to ground)
—	3	—	1	$\overline{\text{SHDN}}$	Shutdown Control Input. Connect to GND to turn off the output. Do not leave this pin floating.
—	—	4	6	Tab	Exposed Thermal Pad, connected to GND

3.1 Ground Pin (GND)

For optimal noise and Power Supply Rejection Ratio (PSRR) performance, the GND pin of the LDO should be tied to an electrically “quiet” circuit ground. This will ensure the LDO power supply rejection ratio and noise device performance. The GND pin of the LDO conducts only ground current and that is why a wide trace is not required. For applications that have switching or noisy inputs, tie the GND pin to the return of the output capacitor. Ground planes help lower the inductance and, as a result, reduce the effect of fast current transients.

3.2 Regulated Output Voltage Pin (V_{OUT})

The V_{OUT} pin is the regulated output voltage V_R of the LDO. A minimum output capacitance of 2.2 μF is required for the LDO to ensure the stability in all the typical applications. The MCP1792/3 is stable with ceramic capacitors. See [Section 4.2 “Output Capacitance Requirements”](#) for output capacitor selection guidance.

3.3 Input Voltage Supply Pin (V_{IN})

Connect the input voltage source to V_{IN}. If the input voltage source is located several inches away from the LDO, or the input source is a battery, it is recommended that an input capacitor be used. A typical input capacitance value of 2.2 μF to 10 μF should be sufficient for most applications. The type of capacitor used is ceramic. However, the low ESR characteristics of the ceramic capacitor will yield better noise and PSRR performance at high frequency.

3.4 Shutdown Control Input ($\overline{\text{SHDN}}$)

The $\overline{\text{SHDN}}$ input is used to turn the LDO output voltage off. When the $\overline{\text{SHDN}}$ input is at a logic high level, the LDO output voltage is enabled. When the $\overline{\text{SHDN}}$ input is pulled to a logic low level, the LDO output voltage is disabled. When the $\overline{\text{SHDN}}$ input is pulled low, the LDO enters a low-quiescent current shutdown state, where the typical quiescent current is 2 μA.

4.0 DETAILED DESCRIPTION

4.1 Device Overview

The MCP1792/3 is an AEC-Q100 qualified LDO capable of outputting 100 mA of current over the entire temperature range. The part is stable with a minimum 2.2 μF ceramic capacitor and features a high-voltage SHDN pin, current foldback protection and extended working temperature range: -40° to $+150^{\circ}$. The device also features an adequate PSRR of 80 dB typical for low frequencies and 55 dB for high frequencies.

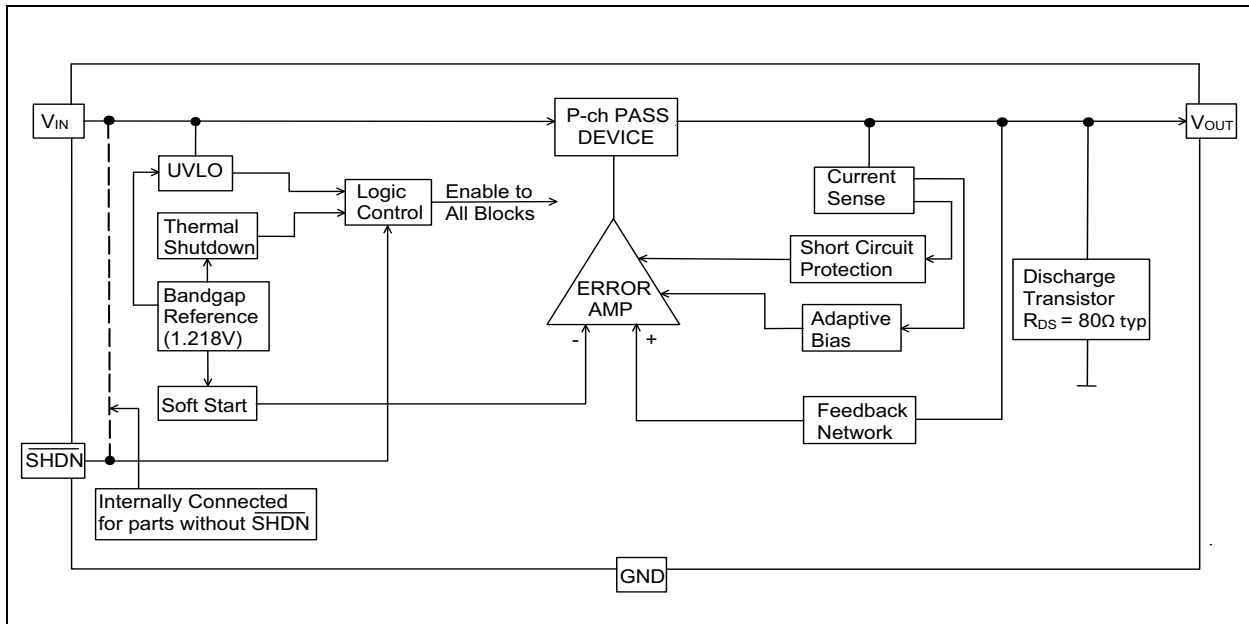

FIGURE 4-1: Functional Block Diagram.

An innovative adaptive bias circuitry is used to lower the power consumption at no load and light loads, without compromising the dynamic response.

The internal discharge transistor is useful in powering microcontrollers and other applications that require fast supply disconnect.

4.2 Output Capacitance Requirements

The MCP1792/3 requires a minimum output capacitance of 2.2 μF for output voltage stability. The output capacitor should be located as close to the LDO output as it is practical. The device is designed to work with low ESR ceramic capacitors. Ceramic materials X8R\L or X7R have low temperature coefficients and are well within the acceptable ESR range required.

A typical 2.2 μF X7R 0805 capacitor has an ESR of 50 m Ω . It is recommended to use an appropriate voltage rating capacitor, and the derating of the capacitance as a function of voltage and temperature needs to be taken into account.

For improved transitory behavior over the entire temperature range, a 3.3 μF output capacitor is recommended. The ceramic capacitor type should be X7R or X8R\L because their dielectrics are rated for use with temperatures between -40°C to $+125^{\circ}\text{C}$ or -55°C to $+150^{\circ}\text{C}$, respectively.

4.3 Input Capacitance Requirements

Low input-source impedance is necessary for the LDO output to operate properly. When operating on batteries, or in applications with long lead length (> 10 inches) between the input source and the LDO, adding input capacitance is recommended. A minimum of 2.2 μF to 10 μF of capacitance is sufficient for most applications. Given the high input voltage capability of the MCP1792/3, of up to 55V DC, it is recommended to use an appropriate voltage rating capacitor, and the derating of the capacitance as a function of voltage and temperature needs to be taken into account. The ceramic capacitor type should be X7R or X8R\L because their dielectrics are rated for use with temperatures between -40°C to $+125^{\circ}\text{C}$ or -55°C to $+150^{\circ}\text{C}$, respectively.

4.4 Circuit Protection

The MCP1792/3 features current foldback protection during an output short-circuit event that occurs in normal operation. When the current foldback block detects an increase in load current, over the typical value of 230 mA, the output current and output voltage will start to decrease until the output current reaches a value of typically 10 mA (see Figure 2-16 and Figure 2-17).

If a short circuit is present during power-up, the part will enter current limit protection.

The MCP1792/3 was tested using the AEC-Q100 test set-up in Figure 4-2. The testing conditions require the use of very high parasitic inductances on the input and output. For cases like this, it is required to prevent the output voltage going below ground with more than 1V. Note that the V_{OUT} pin can withstand a maximum of -0.3 VDC (see Absolute Maximum Ratings †). This can be achieved by placing a Schottky diode with the cathode to V_{OUT} and the anode to ground.

Thermal shutdown functionality is present on the device and adds to the protection features of the part. Thermal shutdown is triggered at a typical value of 175°C and has a typical hysteresis of 15°C.

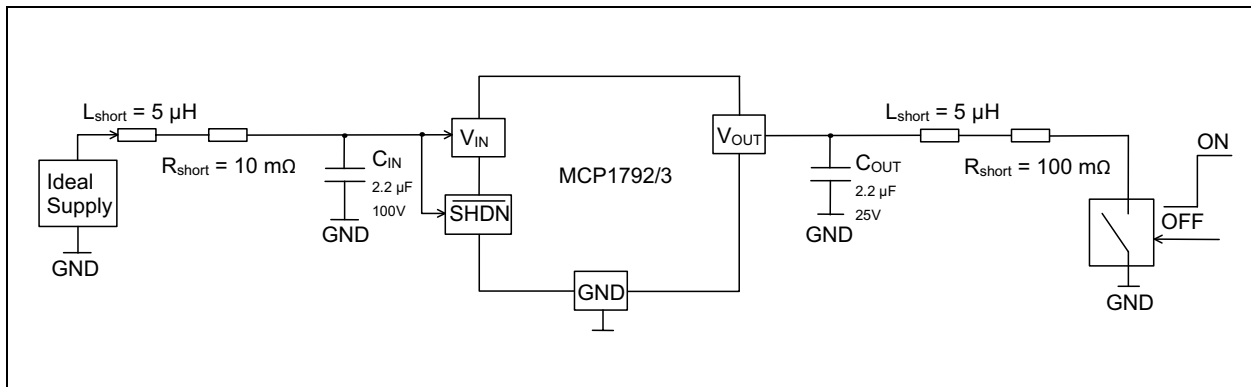

FIGURE 4-2: Short Circuit Test Set-Up.

4.5 Dropout Operation

For $V_R = 5V$, MCP1792/3 can be found operating in a dropout condition (the minimum input voltage is 4.5V), which can happen during cold crank event, when the supply voltage can drop down to 3V. It is preferred to ensure that the part does not operate in dropout during DC operation so that the AC performance is maintained.

The device has a dropout voltage of approximately 250 mV at full load and room temperature, but because of the extended temperature range at 150°C, due to increased leakage at hot, it reaches up to 1200 mV. For a 5V output, the minimum supply voltage required in order to have a regulated output, within specification, is 6.2V.

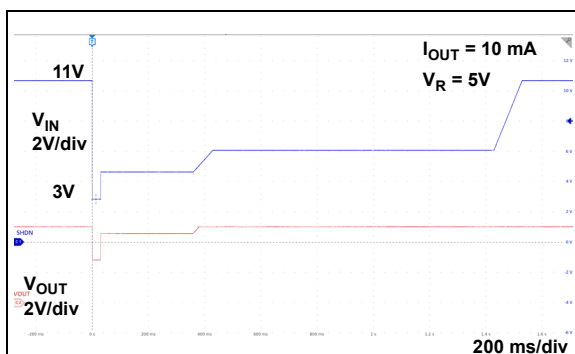

FIGURE 4-3: Line Step from Dropout.

4.6 Shutdown Input ($\overline{\text{SHDN}}$) and Input UVLO

The $\overline{\text{SHDN}}$ input is an active-low input signal that turns the LDO on and off. The $\overline{\text{SHDN}}$ threshold has a logic HIGH level of minimum 2.4V and a logic LOW level of maximum 0.8V.

The $\overline{\text{SHDN}}$ pin ignores low-going pulses that are up to 30 μs . This blanking window helps to reject any system noise spikes on the $\overline{\text{SHDN}}$ input signal. Then, on the rising edge of the $\overline{\text{SHDN}}$ input, the shutdown circuitry adds 770 μs delay before allowing the regulator output to turn on. This delay helps to reject any false turn-on signals or noise on the $\overline{\text{SHDN}}$ input signal. After the (30 + 770) μs delay, the regulator starts charging the load capacitor as the output rises from 0V to its regulated value. The charging current amplitude will be limited by the short circuit current value of the device. If the $\overline{\text{SHDN}}$ input signal is pulled low during the 800 μs delay period, the timer will be reset and the delay time will start over again on the next rising edge of the $\overline{\text{SHDN}}$ input. Figure 4-4 shows a timing diagram of the $\overline{\text{SHDN}}$ input.

The MCP1792/3 has an internal discharge transistor connected to the V_{OUT} PIN that is enabled when the $\overline{\text{SHDN}}$ pin goes low. The discharge occurs through a typical resistance of 80 Ω .

The UVLO block helps prevent false start-ups during the power-up sequence, until the input voltage reaches a value of 2.7V. The minimum input voltage required for normal operation is 4.5V.

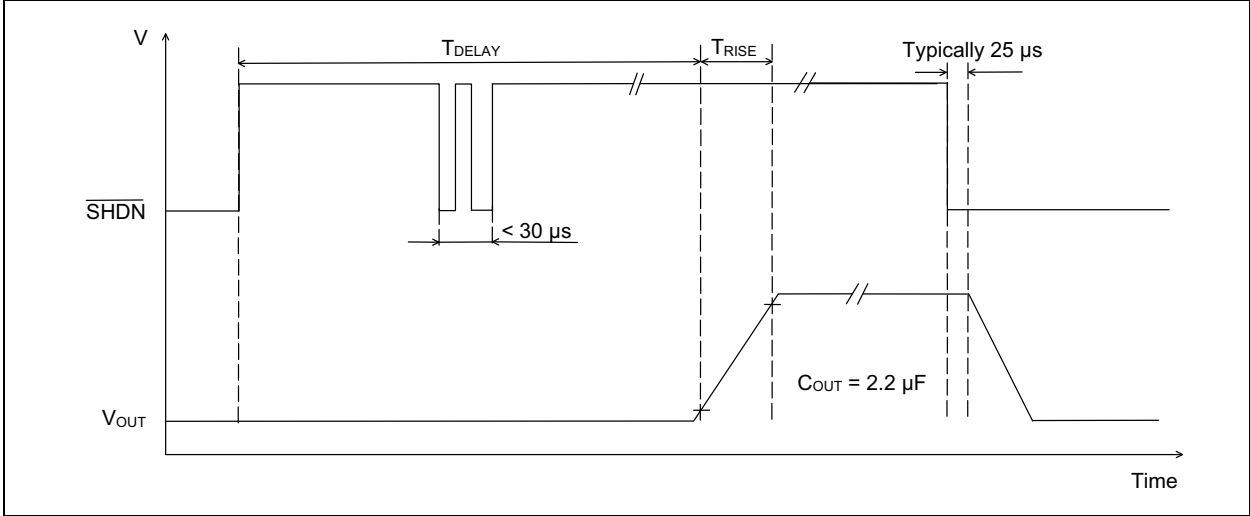

FIGURE 4-4: Shutdown Input Timing Diagram.

4.7 Package and Device Qualifications

The MCP1792/3 are AEC-Q100 with Grade 0 and PPAP Capable. The Grade 0 qualification allows the MCP1792/3 to be used within an extended temperature range from $-40^{\circ}C$ to $+150^{\circ}C$.

Additionally, the package has a moisture sensitivity level (MSL) of 1 for SOT223-5L, SOT23A-3L and SOT23-5L; for SOT223-3L the package has MSL 2 rating.

5.0 APPLICATION INFORMATION

5.1 Typical Application

The MCP1792/3 is used for applications that require high input voltage and are prone to high transient voltages on the input.

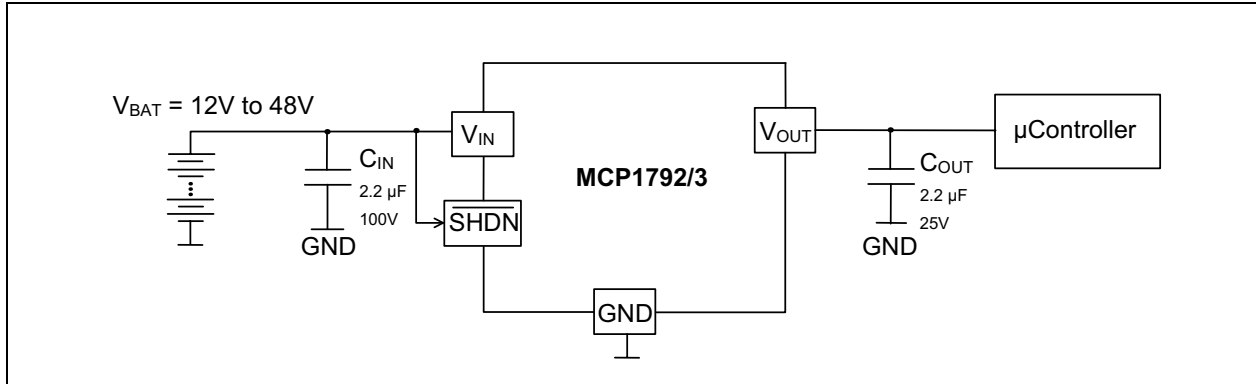

FIGURE 5-1: Typical Application Circuit using a High-Voltage Battery Pack.

5.2 Power Calculations

5.2.1 POWER DISSIPATION

The internal power dissipation within the MCP1792/3 is a function of input voltage, output voltage, output current and quiescent current. Equation 5-1 can be used to calculate the internal power dissipation for the LDO.

EQUATION 5-1:

$$P_{LDO} = (V_{IN(MAX)} - V_{OUT(MIN)}) \times I_{OUT(MAX)}$$

Where:

P_{LDO} = Internal power dissipation of the LDO pass device

$V_{IN(MAX)}$ = Maximum input voltage

$V_{OUT(MIN)}$ = LDO minimum output voltage

$I_{OUT(MAX)}$ = Maximum output current

In addition to the LDO pass element power dissipation, there is power dissipation within the MCP1792/3 as a result of quiescent or ground current. The power dissipation as a result of ground current can be calculated by applying Equation 5-2:

EQUATION 5-2:

$$P_{I(GND)} = V_{IN(MAX)} \times I_{GND}$$

Where:

$P_{I(GND)}$ = Power dissipation due to the ground current of the LDO

$V_{IN(MAX)}$ = Maximum input voltage

I_{GND} = Current flowing into the GND pin

The total power dissipated within the MCP1792/3 is the sum of the power dissipated in the LDO pass device and the $P_{I(GND)}$ term. Because of the CMOS construction, the typical I_{GND} for the MCP1792/3 is typical 100 µA at full load. Operating at a maximum V_{IN} of 55V results in a power dissipation of 5.5 mW. For most applications, this is small compared to the LDO pass device power dissipation and can be neglected.

The maximum continuous operating junction temperature specified for the MCP1792/3 is +150°C. To estimate the internal junction temperature of the MCP1792/3, the total internal power dissipation is multiplied by the thermal resistance from junction-to-ambient (θ_{JA}) of the device. For example, the thermal resistance from junction-to-ambient for the 5-Lead SOT223 package is estimated at 75°C/W.

EQUATION 5-3:

$$T_{J(MAX)} = P_{LDO} \times \theta_{JA} + T_{A(MAX)}$$

Where:

$T_{J(MAX)}$ = Maximum continuous junction temperature

P_{LDO} = Total power dissipation of the device

θ_{JA} = Thermal resistance from junction-to-ambient

$T_{A(MAX)}$ = Maximum ambient temperature

The maximum power dissipation capability for a package can be calculated given the junction-to-ambient thermal resistance and the maximum ambient temperature for the application. Equation 5-4 can be used to determine the package maximum internal power dissipation.

EQUATION 5-4:

$$P_{D(MAX)} = \frac{(T_{J(MAX)} - T_{A(MAX)})}{\theta_{JA}}$$

Where:

- $P_{D(MAX)}$ = Maximum power dissipation of the device
- $T_{J(MAX)}$ = Maximum continuous junction temperature
- $T_{A(MAX)}$ = Maximum ambient temperature
- θ_{JA} = Thermal resistance from junction-to-ambient

EQUATION 5-5:

$$T_{J(RISE)} = P_{D(MAX)} \times \theta_{JA}$$

Where:

- $T_{J(RISE)}$ = Rise in the device junction temperature over the ambient temperature
- $P_{D(MAX)}$ = Maximum power dissipation of the device
- θ_{JA} = Thermal resistance from junction-to-ambient

EQUATION 5-6:

$$T_J = T_{J(RISE)} + T_A$$

Where:

- T_J = Junction temperature
- $T_{J(RISE)}$ = Rise in the device junction temperature over the ambient temperature
- T_A = Ambient temperature

5.3 Typical Application Examples

Internal power dissipation, junction temperature rise, junction temperature and maximum power dissipation are calculated in the following example. The power dissipation as a result of ground current is small enough to be neglected.

5.3.1 POWER DISSIPATION EXAMPLE

EXAMPLE 5-1:

Package

Package Type = 5-Lead SOT223

Input Voltage

$$V_{IN} = 14V \pm 5\%$$

LDO Output Voltage and Current

$$V_{OUT} = 5V$$

$$I_{OUT} = 50 \text{ mA}$$

Maximum Ambient Temperature

$$T_{A(MAX)} = +60^\circ\text{C}$$

Internal Power Dissipation

$$P_{LDO(MAX)} = (V_{IN(MAX)} - V_{OUT(MIN)}) \times I_{OUT(MAX)}$$

$$P_{LDO} = (14.7 - 4.9) \times 50 \text{ mA}$$

$$P_{LDO} = 0.49 \text{ Watts}$$

5.3.1.1 Device Junction Temperature Rise

The internal junction temperature rise is a function of internal power dissipation and of the thermal resistance from junction-to-ambient for the application. The thermal resistance from junction-to-ambient (θ_{JA}) is derived from EIA/JEDEC standards for measuring thermal resistance. The EIA/JEDEC specification is JESD51. The standard describes the test method and board specifications for measuring the thermal resistance from junction-to-ambient. The actual thermal resistance for a particular application can vary depending on many factors such as copper area and thickness. Refer to Application Note AN792, "A Method to Determine How Much Power a SOT23 Can Dissipate in an Application" (DS00792), for more information regarding this subject.

EXAMPLE 5-2:

$$T_{J(RISE)} = P_{TOTAL} \times \theta_{JA}$$

$$T_{J(RISE)} = 0.49W \times 75^\circ\text{C/W}$$

$$T_{J(RISE)} = 36.75^\circ\text{C}$$

5.3.1.2 Junction Temperature Estimate

To estimate the internal junction temperature, the calculated temperature rise is added to the ambient or offset temperature. For this example, the worst-case junction temperature is estimated below:

EXAMPLE 5-3:

$$T_J = T_{J(RISE)} + T_{A(MAX)}$$

$$T_J = 36.75^\circ\text{C} + 60.0^\circ\text{C}$$

$$T_J = 96.75^\circ\text{C}$$

5.3.1.3 Maximum Package Power Dissipation at +60°C Ambient Temperature

EXAMPLE 5-4:

5Lead SOT223 ($\theta_{JA} = 75^\circ\text{C/W}$):

$$P_{D(MAX)} = (150^\circ\text{C} - 60^\circ\text{C})/75^\circ\text{C/W}$$

$$P_{D(MAX)} = 1.2W$$

6.0 BATTERY PACK APPLICATION

The MCP1792/3's features make it suitable for use in smart battery packs. The high SHDN and input voltage range of up to 55V and the transient voltage capability make it adequate for powering low-power microcontrollers used for monitoring battery health.

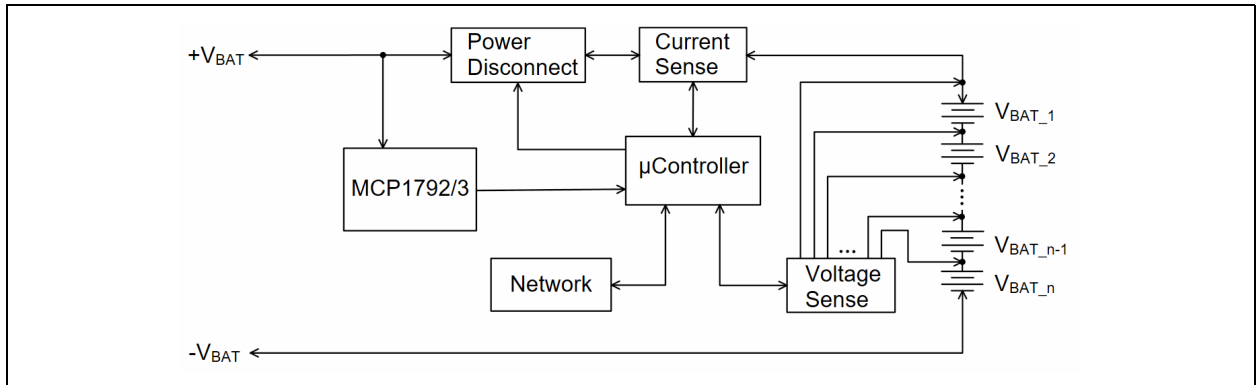
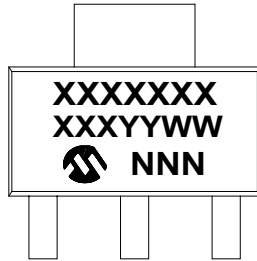

FIGURE 6-1: Smart Battery Pack.

7.0 PACKAGING INFORMATION

7.1 Package Marking Information

3-Lead SOT223



Example

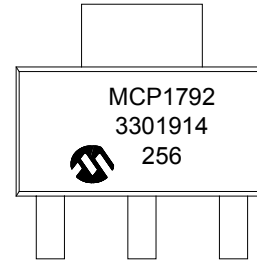

3-Lead SOT23A

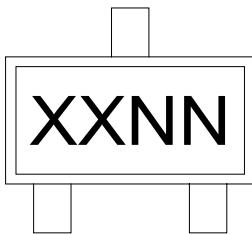

Part Number	Code
MCP1792T-3302H/CB	3325
MCP1792T-5002H/CB	5025

Example

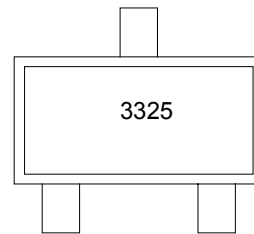

5-Lead SOT223

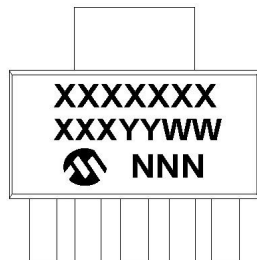

Example

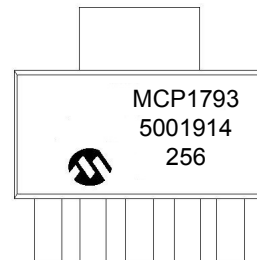

5-Lead SOT23

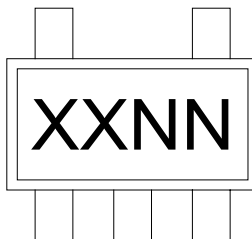

Part Number	Code
MCP1793T-3302H/OT	3325
MCP1793T-5002H/OT	5025

Example

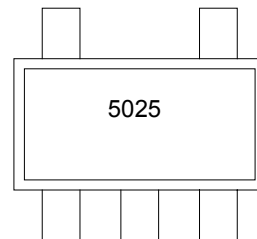

Legend:	XX...X	Customer-specific information
	Y	Year code (last digit of calendar year)
	YY	Year code (last 2 digits of calendar year)
	WW	Week code (week of January 1 is week '01')
	NNN	Alphanumeric traceability code
	(e3)	Pb-free JEDEC® designator for Matte Tin (Sn)
	*	This package is Pb-free. The Pb-free JEDEC designator (e3) can be found on the outer packaging for this package.

Note: In the event the full Microchip part number cannot be marked on one line, it will be carried over to the next line, thus limiting the number of available characters for customer-specific information.

3-Lead Plastic Small Outline Transistor (DB) [SOT-223]

Note: For the most current package drawings, please see the Microchip Packaging Specification located at <http://www.microchip.com/packaging>

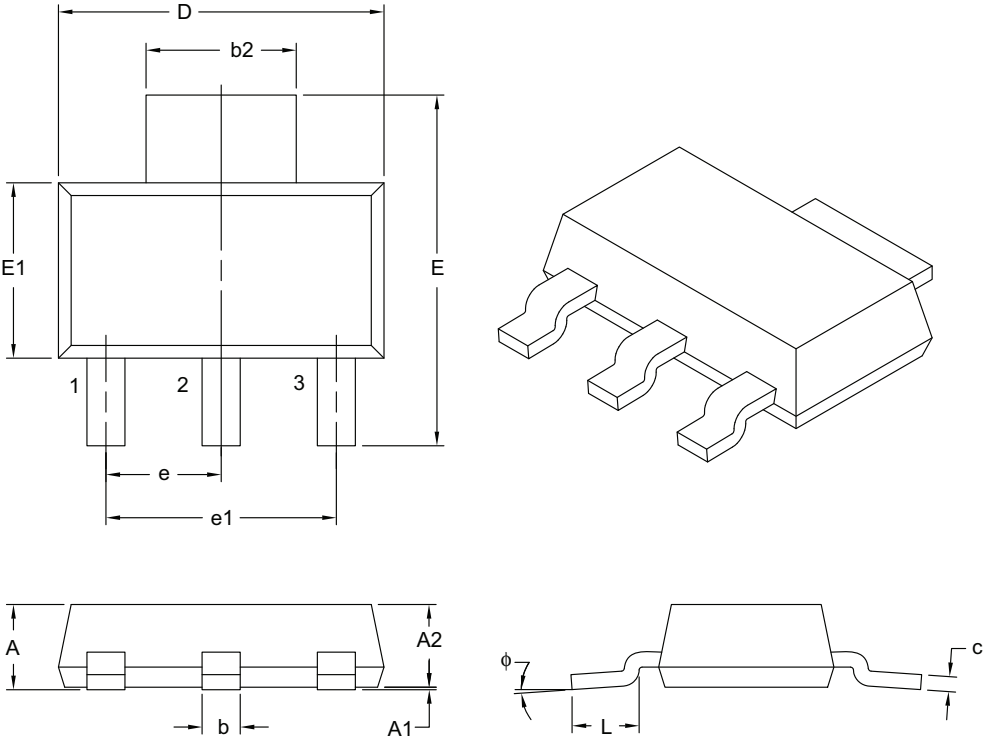

Dimension Limits	Units	MILLIMETERS		
		MIN	NOM	MAX
Number of Leads	N	3		
Lead Pitch	e	2.30 BSC		
Outside Lead Pitch	e1	4.60 BSC		
Overall Height	A	-	-	1.80
Standoff	A1	0.02	-	0.10
Molded Package Height	A2	1.50	1.60	1.70
Overall Width	E	6.70	7.00	7.30
Molded Package Width	E1	3.30	3.50	3.70
Overall Length	D	6.30	6.50	6.70
Lead Thickness	c	0.23	0.30	0.35
Lead Width	b	0.60	0.76	0.84
Tab Lead Width	b2	2.90	3.00	3.10
Foot Length	L	0.75	-	-
Lead Angle	φ	0°	-	10°

- Notes:**
- Dimensions D and E1 do not include mold flash or protrusions. Mold flash or protrusions shall not exceed 0.127 mm per side.
 - Dimensioning and tolerancing per ASME Y14.5M.
BSC: Basic Dimension. Theoretically exact value shown without tolerances.

Microchip Technology Drawing C04-032B

3-Lead Plastic Small Outline Transistor (DB) [SOT-223]

Note: For the most current package drawings, please see the Microchip Packaging Specification located at <http://www.microchip.com/packaging>

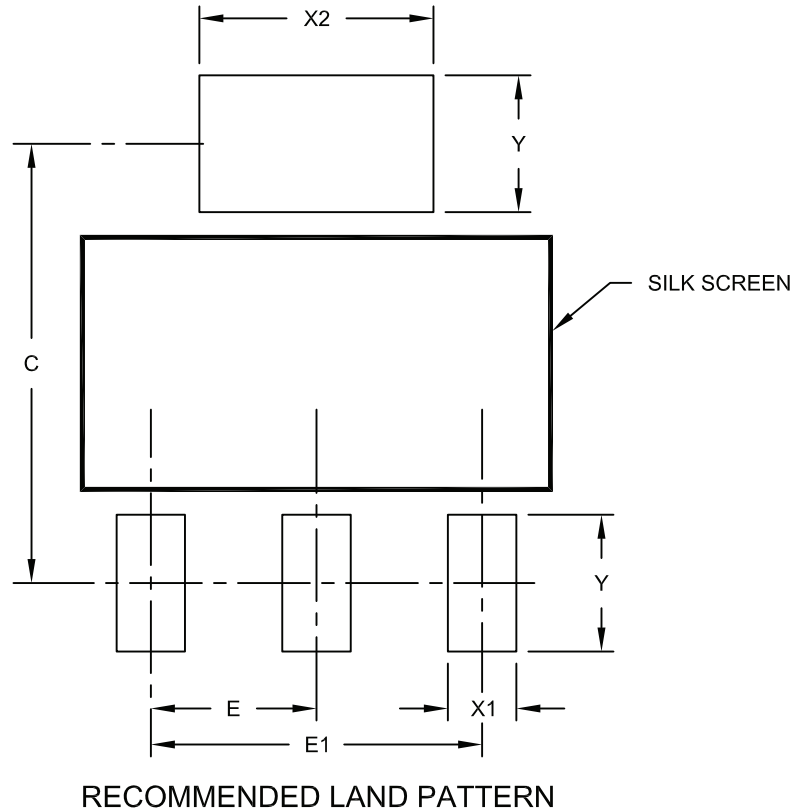

Dimension Limits	Units	MILLIMETERS		
		MIN	NOM	MAX
Contact Pitch	E		2.30 BSC	
Overall Pitch	E1		4.60 BSC	
Contact Pad Spacing	C		6.10	
Contact Pad Width	X1			0.95
Contact Pad Width	X2			3.25
Contact Pad Length	Y			1.90

Notes:

1. Dimensioning and tolerancing per ASME Y14.5M

BSC: Basic Dimension. Theoretically exact value shown without tolerances.

Microchip Technology Drawing No. C04-2032A

3-Lead Plastic Small Outline Transistor (CB) [SOT-23A]

Note: For the most current package drawings, please see the Microchip Packaging Specification located at <http://www.microchip.com/packaging>

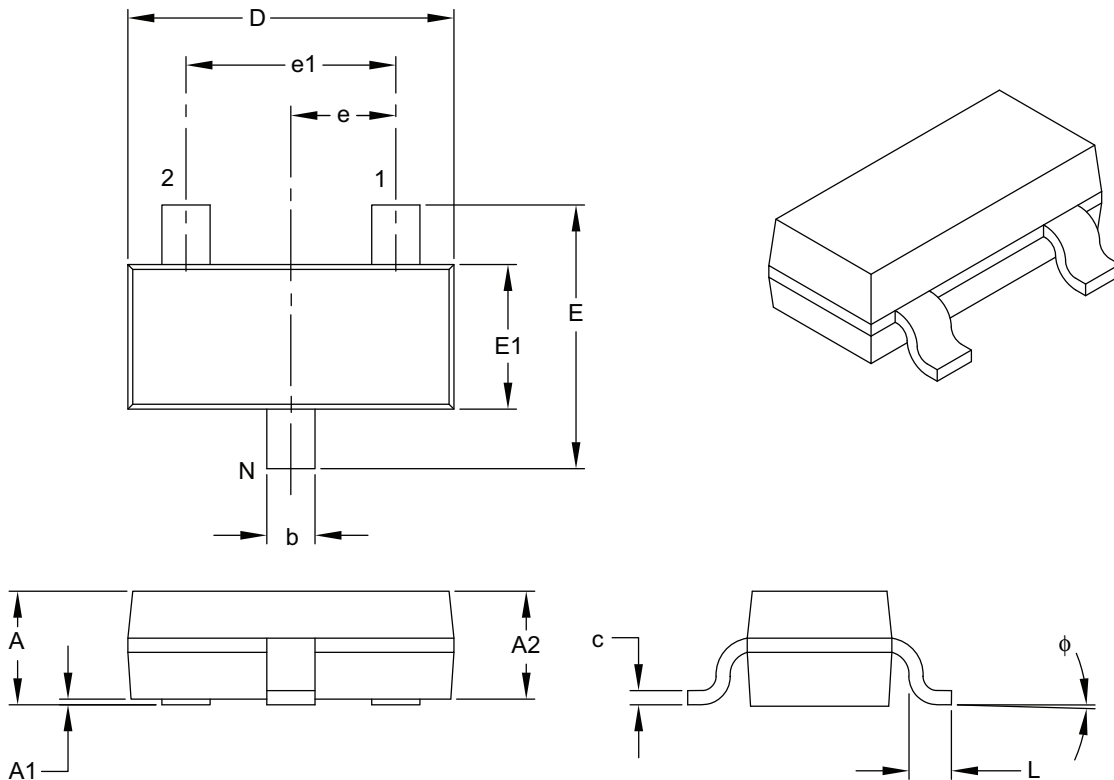

Dimension Limits	Units	MILLIMETERS		
		MIN	NOM	MAX
Number of Pins	N	3		
Lead Pitch	e	0.95 BSC		
Outside Lead Pitch	e1	1.90 BSC		
Overall Height	A	0.89	–	1.45
Molded Package Thickness	A2	0.90	–	1.30
Standoff	A1	0.00	–	0.15
Overall Width	E	2.10	–	3.00
Molded Package Width	E1	1.20	–	1.80
Overall Length	D	2.70	–	3.10
Foot Length	L	0.15	–	0.60
Foot Angle	ϕ	0°	–	30°
Lead Thickness	c	0.09	–	0.26
Lead Width	b	0.30	–	0.51

Notes:

- Dimensions D and E1 do not include mold flash or protrusions. Mold flash or protrusions shall not exceed 0.127 mm per side.
- Dimensioning and tolerancing per ASME Y14.5M.

BSC: Basic Dimension. Theoretically exact value shown without tolerances.

Microchip Technology Drawing C04-130B

3-Lead Plastic Small Outline Transistor (CB) [SOT-23A]

Note: For the most current package drawings, please see the Microchip Packaging Specification located at <http://www.microchip.com/packaging>

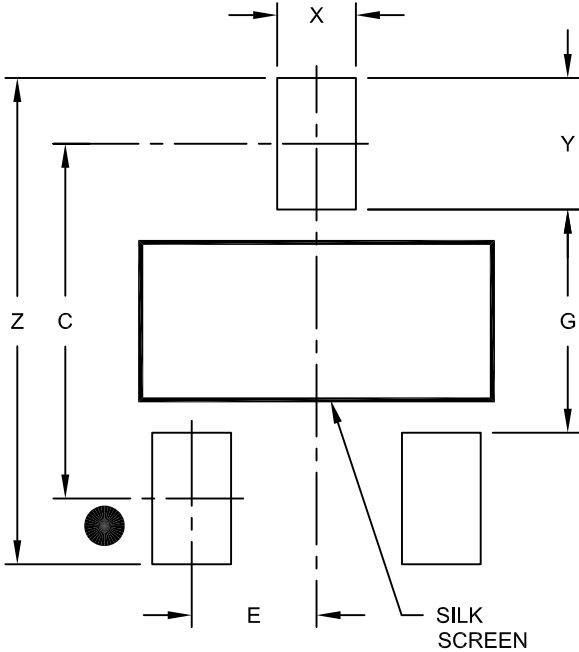

RECOMMENDED LAND PATTERN

Units		MILLIMETERS		
Dimension Limits		MIN	NOM	MAX
Contact Pitch	E	0.95 BSC		
Contact Pad Spacing	C		2.70	
Contact Pad Width (X3)	X			0.60
Contact Pad Length (X3)	Y			1.00
Distance Between Pads	G	1.70		
Overall Width	Z			3.70

Notes:

- 1. Dimensioning and tolerancing per ASME Y14.5M
 BSC: Basic Dimension. Theoretically exact value shown without tolerances.

Microchip Technology Drawing No. C04-2130A

5-Lead Plastic Small Outline Transistor (DC) [SOT-223]

Note: For the most current package drawings, please see the Microchip Packaging Specification located at <http://www.microchip.com/packaging>

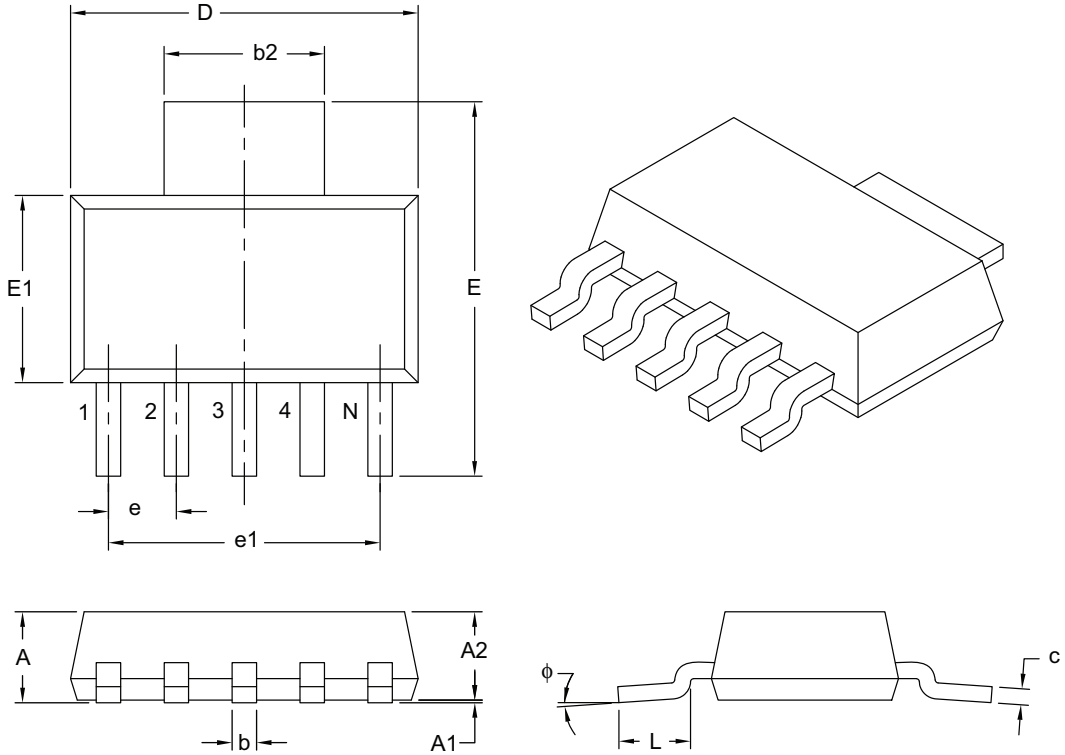

Dimension Limits	Units	MILLIMETERS		
		MIN	NOM	MAX
Number of Leads	N	5		
Lead Pitch	e	1.27 BSC		
Outside Lead Pitch	e1	5.08 BSC		
Overall Height	A	–	–	1.80
Standoff	A1	0.02	0.06	0.10
Molded Package Height	A2	1.55	1.60	1.65
Overall Width	E	6.86	7.00	7.26
Molded Package Width	E1	3.45	3.50	3.55
Overall Length	D	6.45	6.50	6.55
Lead Thickness	c	0.24	0.28	0.32
Lead Width	b	0.41	0.457	0.51
Tab Lead Width	b2	2.95	3.00	3.05
Foot Length	L	0.91	–	1.14
Lead Angle	ϕ	0°	4°	8°

- Notes:**
- Dimensions D and E1 do not include mold flash or protrusions. Mold flash or protrusions shall not exceed 0.127 mm per side.
 - Dimensioning and tolerancing per ASME Y14.5M.
BSC: Basic Dimension. Theoretically exact value shown without tolerances.

Microchip Technology Drawing C04-137B

5-Lead Plastic Small Outline Transistor (DC) [SOT-223]

Note: For the most current package drawings, please see the Microchip Packaging Specification located at <http://www.microchip.com/packaging>

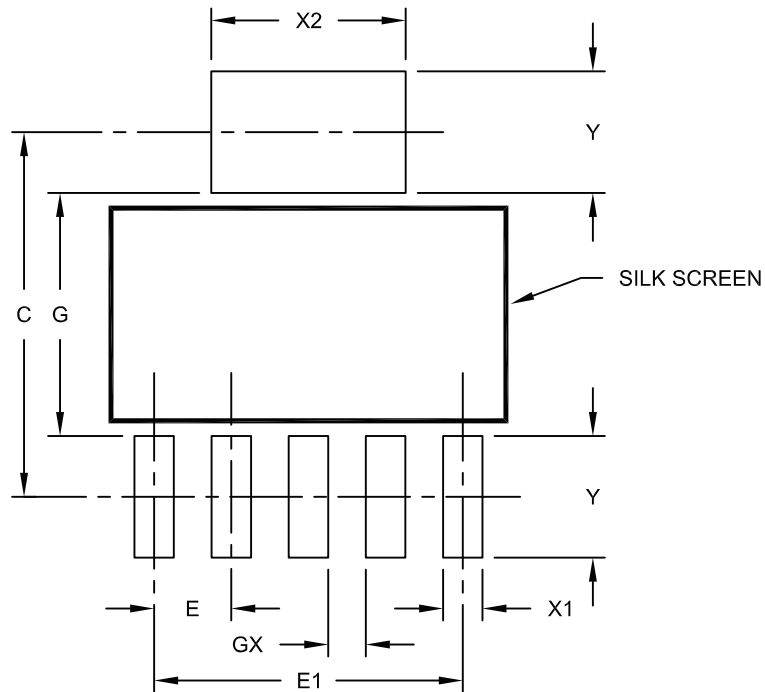

RECOMMENDED LAND PATTERN

Dimension Limits	Units	MILLIMETERS		
		MIN	NOM	MAX
Pad Pitch	E	1.27 BSC		
Overall Pad Pitch	E1	5.08 BSC		
Pad Spacing	C	6.00		
Pad Width	X1			0.65
Pad Width	X2			3.20
Pad Length	Y			2.00
Distance Between Pads	G	4.00		
Distance Between Pads	GX	0.62		

Notes:

1. Dimensioning and tolerancing per ASME Y14.5M

BSC: Basic Dimension. Theoretically exact value shown without tolerances.

Microchip Technology Drawing No. C04-2137A

5-Lead Plastic Small Outline Transistor (OT) [SOT23]

Note: For the most current package drawings, please see the Microchip Packaging Specification located at <http://www.microchip.com/packaging>

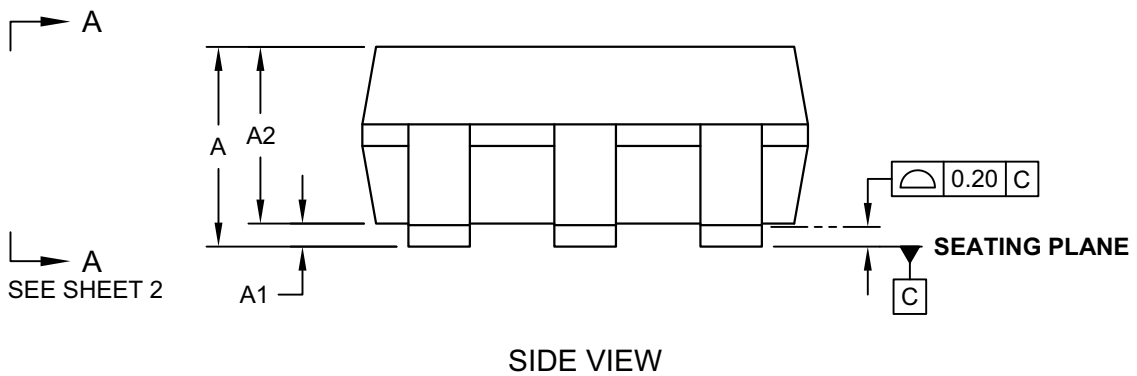
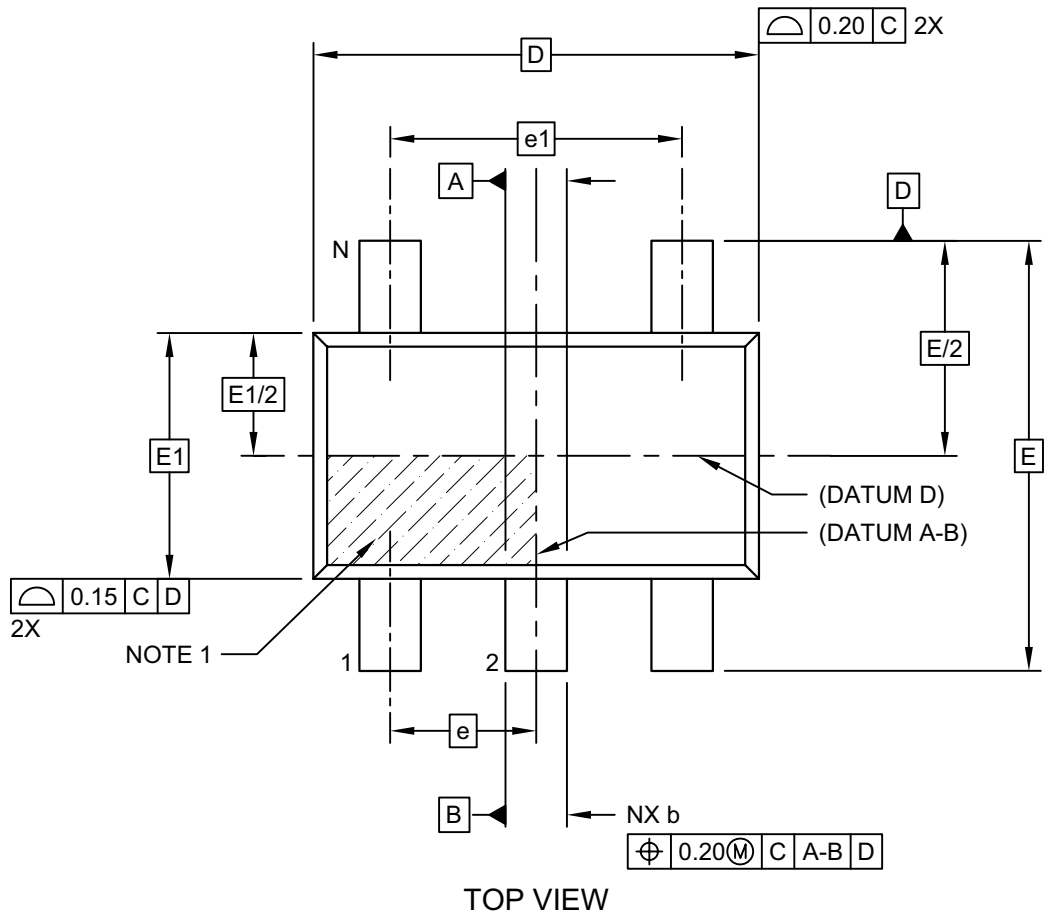

Microchip Technology Drawing C04-091-OT Rev E Sheet 1 of 2

5-Lead Plastic Small Outline Transistor (OT) [SOT23]

Note: For the most current package drawings, please see the Microchip Packaging Specification located at <http://www.microchip.com/packaging>

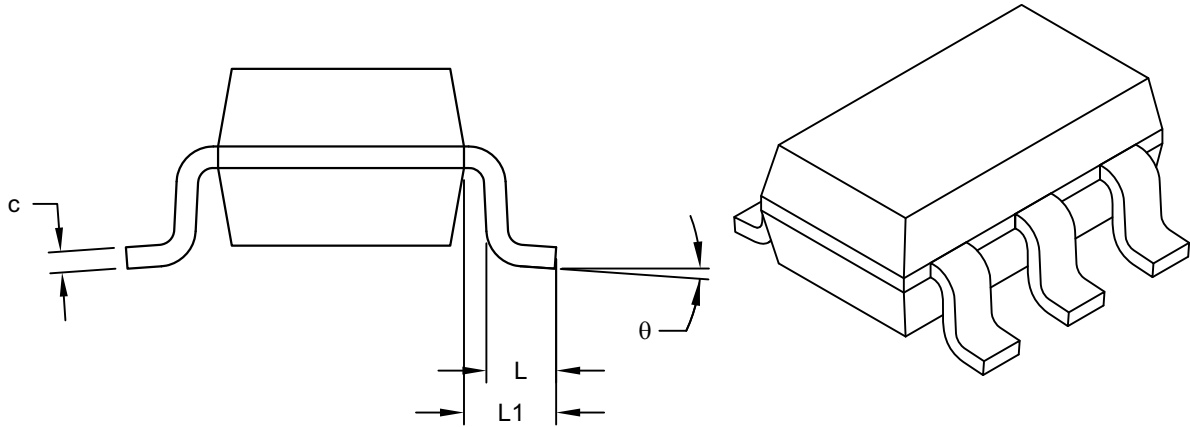

VIEW A-A
SHEET 1

Dimension Limits	Units	MILLIMETERS		
		MIN	NOM	MAX
Number of Pins	N	5		
Pitch	e	0.95 BSC		
Outside lead pitch	e1	1.90 BSC		
Overall Height	A	0.90	-	1.45
Molded Package Thickness	A2	0.89	-	1.30
Standoff	A1	-	-	0.15
Overall Width	E	2.80 BSC		
Molded Package Width	E1	1.60 BSC		
Overall Length	D	2.90 BSC		
Foot Length	L	0.30	-	0.60
Footprint	L1	0.60 REF		
Foot Angle	φ	0°	-	10°
Lead Thickness	c	0.08	-	0.26
Lead Width	b	0.20	-	0.51

Notes:

- Dimensions D and E1 do not include mold flash or protrusions. Mold flash or protrusions shall not exceed 0.25mm per side.
- Dimensioning and tolerancing per ASME Y14.5M
 BSC: Basic Dimension. Theoretically exact value shown without tolerances.
 REF: Reference Dimension, usually without tolerance, for information purposes only.

5-Lead Plastic Small Outline Transistor (OT) [SOT23]

Note: For the most current package drawings, please see the Microchip Packaging Specification located at <http://www.microchip.com/packaging>

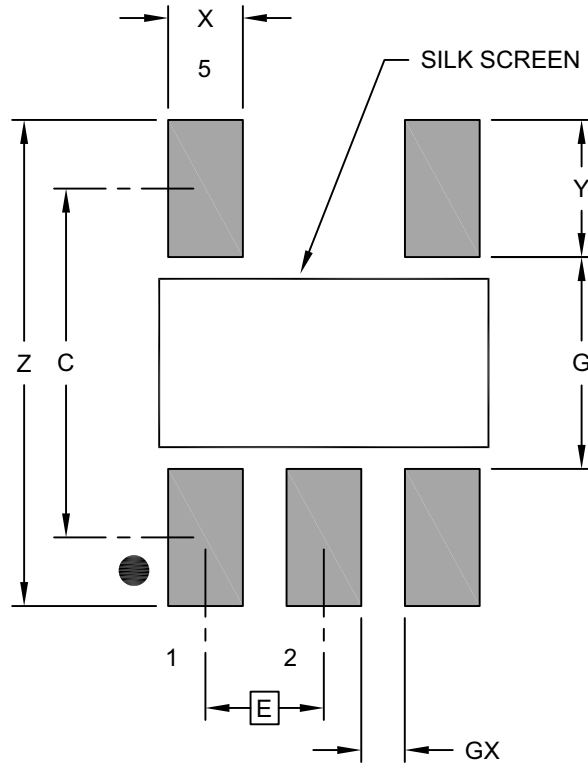

RECOMMENDED LAND PATTERN

Dimension Limits	Units	MILLIMETERS		
		MIN	NOM	MAX
Contact Pitch	E	0.95 BSC		
Contact Pad Spacing	C		2.80	
Contact Pad Width (X5)	X			0.60
Contact Pad Length (X5)	Y			1.10
Distance Between Pads	G	1.70		
Distance Between Pads	GX	0.35		
Overall Width	Z			3.90

Notes:

1. Dimensioning and tolerancing per ASME Y14.5M

BSC: Basic Dimension. Theoretically exact value shown without tolerances.

Microchip Technology Drawing No. C04-2091B [OT]

APPENDIX A: REVISION HISTORY

Revision A (July 2019)

- Initial release of this document.

Revision B (October 2019)

The following is the list of modifications:

1. Updated device **Features**.
2. Updated **Package Types**.
3. Updated the **AC/DC Characteristics** table.
4. Changed symbols in **Figure 4-1**.
5. Added clarifying information in **Section 4.4, "Circuit Protection"** by specifying the type of diode necessary to prevent output voltage drop.
6. Updated text in **Section 4.2, "Output Capacitance Requirements"**.
7. Added extra paragraph in **Section 4.6, "Shutdown Input (SHDN) and Input UVLO"**.
8. Changed power dissipation value when operating at a maximum V_{IN} in **Section 5.2, "Power Calculations"**.
9. Corrected device description in **Product Identification System**.
10. Minor typographical changes throughout.

Revision C (April 2020)

The following is the list of modifications:

- Updated device **Features**.
- Updated **Product Identification System**.

PRODUCT IDENTIFICATION SYSTEM

To order or obtain information, e.g., on pricing or delivery, refer to the factory or the listed sales office.

<u>PART NO.</u>	<u>-X⁽¹⁾</u>	<u>-XX</u>	<u>X</u>	<u>X</u>	<u>X/</u>	<u>XX</u>	Examples:
Device	Tape and Reel	Output Voltage	Featured Code	Tolerance	Temp.	Package	
Device:		MCP1792T: 100 mA High-Voltage Automotive LDO					a) MCP1792T-3302H/DB: Tape and Reel, 3.3V output voltage, Automotive temperature, 3-LD SOT-223 package
		MCP1793T: 100 mA High-Voltage Automotive LDO					b) MCP1792T-5002H/DB: Tape and Reel, 5.0V output voltage, Automotive temperature, 3-LD SOT-223 package
Standard Output Voltages:		33 = 3.3V					c) MCP1793T-4102H/DB: Tape and Reel, 4.1V output voltage, Automotive temperature, 3-LD SOT-223 package
		50 = 5.0V					d) MCP1792T-3302H/CB: Tape and Reel, 3.3V output voltage, Automotive temperature, 3-LD SOT-23A package
		41 = 4.1V					e) MCP1792T-5002H/CB: Tape and Reel, 5.0V output voltage, Automotive temperature, 3-LD SOT-23A package
Temperature:		H = -40°C to +150°C (Automotive)					f) MCP1793T-4102H/CB: Tape and Reel, 4.1V output voltage, Automotive temperature, 3-LD SOT-23A package
Feature Code:		0 = Fixed					g) MCP1793T-3302H/DC: Tape and Reel, 3.3V output voltage, Automotive temperature, 5-LD SOT-223 package
Tolerance:		2 = Standard Accuracy					h) MCP1793T-5002H/DC: Tape and Reel, 5.0V output voltage, Automotive temperature, 5-LD SOT-223 package
Package Type:		DB = 3-Lead Plastic Small Outline Transistor, SOT-223					i) MCP1793T-4102H/DC: Tape and Reel, 4.1V output voltage, Automotive temperature, 5-LD SOT-223 package
		CB = 3-Lead Plastic Small Outline Transistor, SOT-23A					j) MCP1793T-3302H/OT: Tape and Reel, 3.3V output voltage, Automotive temperature, 5-LD SOT-23 package
		DC = 5-Lead Plastic Small Outline Transistor, SOT-223					k) MCP1793T-5002H/OT: Tape and Reel, 5.0V output voltage, Automotive temperature, 5-LD SOT-23 package
		OT = 5-Lead Plastic Small Outline Transistor, SOT-23					l) MCP1793T-4102H/OT: Tape and Reel, 4.1V output voltage, Automotive temperature, 5-LD SOT-23 package
							Note 1: Tape and Reel identifier only appears in the catalog part number description. This identifier is used for ordering purposes and is not printed on the device package. Check with your Microchip Sales Office for package availability with the Tape and Reel option.

Note the following details of the code protection feature on Microchip devices:

- Microchip products meet the specification contained in their particular Microchip Data Sheet.
- Microchip believes that its family of products is one of the most secure families of its kind on the market today, when used in the intended manner and under normal conditions.
- There are dishonest and possibly illegal methods used to breach the code protection feature. All of these methods, to our knowledge, require using the Microchip products in a manner outside the operating specifications contained in Microchip's Data Sheets. Most likely, the person doing so is engaged in theft of intellectual property.
- Microchip is willing to work with the customer who is concerned about the integrity of their code.
- Neither Microchip nor any other semiconductor manufacturer can guarantee the security of their code. Code protection does not mean that we are guaranteeing the product as “unbreakable.”

Code protection is constantly evolving. We at Microchip are committed to continuously improving the code protection features of our products. Attempts to break Microchip's code protection feature may be a violation of the Digital Millennium Copyright Act. If such acts allow unauthorized access to your software or other copyrighted work, you may have a right to sue for relief under that Act.

Information contained in this publication regarding device applications and the like is provided only for your convenience and may be superseded by updates. It is your responsibility to ensure that your application meets with your specifications. MICROCHIP MAKES NO REPRESENTATIONS OR WARRANTIES OF ANY KIND WHETHER EXPRESS OR IMPLIED, WRITTEN OR ORAL, STATUTORY OR OTHERWISE, RELATED TO THE INFORMATION, INCLUDING BUT NOT LIMITED TO ITS CONDITION, QUALITY, PERFORMANCE, MERCHANTABILITY OR FITNESS FOR PURPOSE. Microchip disclaims all liability arising from this information and its use. Use of Microchip devices in life support and/or safety applications is entirely at the buyer's risk, and the buyer agrees to defend, indemnify and hold harmless Microchip from any and all damages, claims, suits, or expenses resulting from such use. No licenses are conveyed, implicitly or otherwise, under any Microchip intellectual property rights unless otherwise stated.

Trademarks

The Microchip name and logo, the Microchip logo, Adaptec, AnyRate, AVR, AVR logo, AVR Freaks, BesTime, BitCloud, chipKIT, chipKIT logo, CryptoMemory, CryptoRF, dsPIC, FlashFlex, flexPWR, HELDO, IGLoo, JukeBlox, KeeLoq, Klear, LANCheck, LinkMD, maXStylus, maXTouch, MediaLB, megaAVR, Microsemi, Microsemi logo, MOST, MOST logo, MPLAB, OptoLyzer, PackeTime, PIC, picoPower, PICSTART, PIC32 logo, PolarFire, Prochip Designer, QTouch, SAM-BA, SenGenuity, SpyNIC, SST, SST Logo, SuperFlash, Symmetricom, SyncServer, Tachyon, TempTrackr, TimeSource, tinyAVR, UNI/O, Vectron, and XMEGA are registered trademarks of Microchip Technology Incorporated in the U.S.A. and other countries.

APT, ClockWorks, The Embedded Control Solutions Company, EtherSynch, FlashTec, Hyper Speed Control, HyperLight Load, IntelliMOS, Libero, motorBench, mTouch, Powermite 3, Precision Edge, ProASIC, ProASIC Plus, ProASIC Plus logo, Quiet-Wire, SmartFusion, SyncWorld, Temux, TimeCesium, TimeHub, TimePictra, TimeProvider, Vite, WinPath, and ZL are registered trademarks of Microchip Technology Incorporated in the U.S.A.

Adjacent Key Suppression, AKS, Analog-for-the-Digital Age, Any Capacitor, AnyIn, AnyOut, BlueSky, BodyCom, CodeGuard, CryptoAuthentication, CryptoAutomotive, CryptoCompanion, CryptoController, dsPICDEM, dsPICDEM.net, Dynamic Average Matching, DAM, ECAN, EtherGREEN, In-Circuit Serial Programming, ICSP, INICnet, Inter-Chip Connectivity, JitterBlocker, KlearNet, KlearNet logo, memBrain, Mindi, MiWi, MPASM, MPF, MPLAB Certified logo, MPLIB, MPLINK, MultiTRAK, NetDetach, Omniscient Code Generation, PICDEM, PICDEM.net, PICKit, PICtail, PowerSmart, PureSilicon, QMatrix, REAL ICE, Ripple Blocker, SAM-ICE, Serial Quad I/O, SMART-I.S., SQI, SuperSwitcher, SuperSwitcher II, Total Endurance, TSHARC, USBCheck, VariSense, ViewSpan, WiperLock, Wireless DNA, and ZENA are trademarks of Microchip Technology Incorporated in the U.S.A. and other countries.

SQTP is a service mark of Microchip Technology Incorporated in the U.S.A.

The Adaptec logo, Frequency on Demand, Silicon Storage Technology, and Symmcom are registered trademarks of Microchip Technology Inc. in other countries.

GestIC is a registered trademark of Microchip Technology Germany II GmbH & Co. KG, a subsidiary of Microchip Technology Inc., in other countries.

All other trademarks mentioned herein are property of their respective companies.

© 2020, Microchip Technology Incorporated, All Rights Reserved.

ISBN: 978-1-5224-5988-0

For information regarding Microchip's Quality Management Systems, please visit www.microchip.com/quality.



MICROCHIP

Worldwide Sales and Service

AMERICAS

Corporate Office
2355 West Chandler Blvd.
Chandler, AZ 85224-6199
Tel: 480-792-7200
Fax: 480-792-7277
Technical Support:
<http://www.microchip.com/support>
Web Address:
www.microchip.com

Atlanta

Duluth, GA
Tel: 678-957-9614
Fax: 678-957-1455

Austin, TX

Tel: 512-257-3370

Boston

Westborough, MA
Tel: 774-760-0087
Fax: 774-760-0088

Chicago

Itasca, IL
Tel: 630-285-0071
Fax: 630-285-0075

Dallas

Addison, TX
Tel: 972-818-7423
Fax: 972-818-2924

Detroit

Novi, MI
Tel: 248-848-4000

Houston, TX

Tel: 281-894-5983

Indianapolis

Noblesville, IN
Tel: 317-773-8323
Fax: 317-773-5453
Tel: 317-536-2380

Los Angeles

Mission Viejo, CA
Tel: 949-462-9523
Fax: 949-462-9608
Tel: 951-273-7800

Raleigh, NC

Tel: 919-844-7510

New York, NY

Tel: 631-435-6000

San Jose, CA

Tel: 408-735-9110
Tel: 408-436-4270

Canada - Toronto

Tel: 905-695-1980
Fax: 905-695-2078

ASIA/PACIFIC

Australia - Sydney
Tel: 61-2-9868-6733

China - Beijing
Tel: 86-10-8569-7000

China - Chengdu
Tel: 86-28-8665-5511

China - Chongqing
Tel: 86-23-8980-9588

China - Dongguan
Tel: 86-769-8702-9880

China - Guangzhou
Tel: 86-20-8755-8029

China - Hangzhou
Tel: 86-571-8792-8115

China - Hong Kong SAR
Tel: 852-2943-5100

China - Nanjing
Tel: 86-25-8473-2460

China - Qingdao
Tel: 86-532-8502-7355

China - Shanghai
Tel: 86-21-3326-8000

China - Shenyang
Tel: 86-24-2334-2829

China - Shenzhen
Tel: 86-755-8864-2200

China - Suzhou
Tel: 86-186-6233-1526

China - Wuhan
Tel: 86-27-5980-5300

China - Xian
Tel: 86-29-8833-7252

China - Xiamen
Tel: 86-592-2388138

China - Zhuhai
Tel: 86-756-3210040

ASIA/PACIFIC

India - Bangalore
Tel: 91-80-3090-4444

India - New Delhi
Tel: 91-11-4160-8631

India - Pune
Tel: 91-20-4121-0141

Japan - Osaka
Tel: 81-6-6152-7160

Japan - Tokyo
Tel: 81-3-6880-3770

Korea - Daegu
Tel: 82-53-744-4301

Korea - Seoul
Tel: 82-2-554-7200

Malaysia - Kuala Lumpur
Tel: 60-3-7651-7906

Malaysia - Penang
Tel: 60-4-227-8870

Philippines - Manila
Tel: 63-2-634-9065

Singapore
Tel: 65-6334-8870

Taiwan - Hsin Chu
Tel: 886-3-577-8366

Taiwan - Kaohsiung
Tel: 886-7-213-7830

Taiwan - Taipei
Tel: 886-2-2508-8600

Thailand - Bangkok
Tel: 66-2-694-1351

Vietnam - Ho Chi Minh
Tel: 84-28-5448-2100

EUROPE

Austria - Wels
Tel: 43-7242-2244-39
Fax: 43-7242-2244-393

Denmark - Copenhagen
Tel: 45-4485-5910
Fax: 45-4485-2829

Finland - Espoo
Tel: 358-9-4520-820

France - Paris
Tel: 33-1-69-53-63-20
Fax: 33-1-69-30-90-79

Germany - Garching
Tel: 49-8931-9700

Germany - Haan
Tel: 49-2129-3766400

Germany - Heilbronn
Tel: 49-7131-72400

Germany - Karlsruhe
Tel: 49-721-625370

Germany - Munich
Tel: 49-89-627-144-0
Fax: 49-89-627-144-44

Germany - Rosenheim
Tel: 49-8031-354-560

Israel - Ra'anana
Tel: 972-9-744-7705

Italy - Milan
Tel: 39-0331-742611
Fax: 39-0331-466781

Italy - Padova
Tel: 39-049-7625286

Netherlands - Drunen
Tel: 31-416-690399
Fax: 31-416-690340

Norway - Trondheim
Tel: 47-7288-4388

Poland - Warsaw
Tel: 48-22-3325737

Romania - Bucharest
Tel: 40-21-407-87-50

Spain - Madrid
Tel: 34-91-708-08-90
Fax: 34-91-708-08-91

Sweden - Gothenberg
Tel: 46-31-704-60-40

Sweden - Stockholm
Tel: 46-8-5090-4654

UK - Wokingham
Tel: 44-118-921-5800
Fax: 44-118-921-5820

X-ON Electronics

Largest Supplier of Electrical and Electronic Components

Click to view similar products for [LDO Voltage Regulators](#) category:

Click to view products by [Microchip](#) manufacturer:

Other Similar products are found below :

[AP7363-SP-13](#) [L79M05TL-E](#) [PT7M8202B12TA5EX](#) [TCR3DF185,LM\(CT](#) [TCR3DF24,LM\(CT](#) [TCR3DF285,LM\(CT](#) [TCR3DF31,LM\(CT](#)
[TCR3DF45,LM\(CT](#) [MP2013GQ-33-Z](#) [059985X](#) [NCP4687DH15T1G](#) [701326R](#) [TCR2EN28,LF\(S](#) [NCV8170AXV250T2G](#)
[TCR3DF27,LM\(CT](#) [TCR3DF19,LM\(CT](#) [TCR3DF125,LM\(CT](#) [TCR2EN18,LF\(S](#) [AP7315-25W5-7](#) [IFX30081LDVGRNXUMA1](#)
[NCV47411PAAJR2G](#) [AP2113KTR-G1](#) [AP2111H-1.2TRG1](#) [ZLDO1117QK50TC](#) [AZ1117IH-1.8TRG1](#) [TCR3DG12,LF](#) [MIC5514-3.3YMT-](#)
[T5](#) [MIC5512-1.2YMT-T5](#) [MIC5317-2.8YM5-T5](#) [SCD7912BTG](#) [NCP154MX180270TAG](#) [SCD33269T-5.0G](#) [NCV8170BMX330TCG](#)
[NCV8170AMX120TCG](#) [NCP706ABMX300TAG](#) [NCP153MX330180TCG](#) [NCP114BMX075TCG](#) [MC33269T-3.5G](#) [CAT6243-ADJCMT5T](#)
[TCR3DG33,LF](#) [AP2127N-1.0TRG1](#) [TCR4DG35,LF](#) [LT1117CST-3.3](#) [LT1117CST-5](#) [TAR5S15U\(TE85L,F\)](#) [TAR5S18U\(TE85L,F\)](#)
[TCR3UG19A,LF](#) [TCR4DG105,LF](#) [NCV8170AMX360TCG](#) [MIC94310-NYMT-T5](#)