

---

## Stand-Alone System Load Sharing and Li-Ion/Li-Polymer Battery Charge Management Controller

---

### Features

- Integrated System Load Sharing and Battery Charge Management
  - Simultaneously Power the System and Charge the Li-Ion Battery
  - Voltage Proportional Current Control (VPCC) ensures system load has priority over Li-Ion battery charge current
  - Low-Loss Power-Path Management with Ideal Diode Operation
- Complete Linear Charge Management Controller
  - Integrated Pass Transistors
  - Integrated Current Sense
  - Integrated Reverse Discharge Protection
  - Selectable Input Power Sources: USB Port or AC-DC Wall Adapter
- Preset High Accuracy Charge Voltage Options:
  - 4.10V, 4.20V, 4.35V or 4.40V
  - $\pm 0.5\%$  Regulation Tolerance
- Constant Current/Constant Voltage (CC/CV) Operation with Thermal Regulation
- Maximum 1.8A Total Input Current Control
- Resistor Programmable Fast Charge Current Control: 50 mA to 1A
- Resistor Programmable Termination Set Point
- Selectable USB Input Current Control
  - Absolute Maximum: 100 mA (L)/500 mA (H)
- Automatic Recharge
- Automatic End-of-Charge Control
- Safety Timer With Timer Enable/Disable Control
- 0.1C Preconditioning for Deeply Depleted Cells
- Battery Cell Temperature Monitor
- Undervoltage Lockout (UVLO)
- Low Battery Status Indicator ( $\overline{\text{LBO}}$ )
- Power Good Status Indicator ( $\overline{\text{PG}}$ )
- Charge Status and Fault Condition Indicators
- Numerous Selectable Options Available for a Variety of Applications:
  - Refer to **Section 1.0 “Electrical Characteristics”** for Selectable Options
  - Refer to the **Product Identification System** for Standard Options
- Temperature Range:  $-40^{\circ}\text{C}$  to  $+85^{\circ}\text{C}$
- Packaging: 20-Lead QFN (4 mm x 4 mm)

### Applications

- GPSs/Navigators
- PDAs and Smart Phones
- Portable Media Players and MP3 Players
- Digital Cameras
- Bluetooth® Headsets
- Portable Medical Devices
- Charge Cradles/Docking Stations
- Toys

### Description

The MCP73871 device is a fully integrated linear solution for system load sharing and Li-Ion/Li-Polymer battery charge management with AC-DC wall adapter and USB port power sources selection. It is also capable of autonomous power source selection between input and battery. Along with its small physical size, the low number of required external components makes the device ideally suited for portable applications.

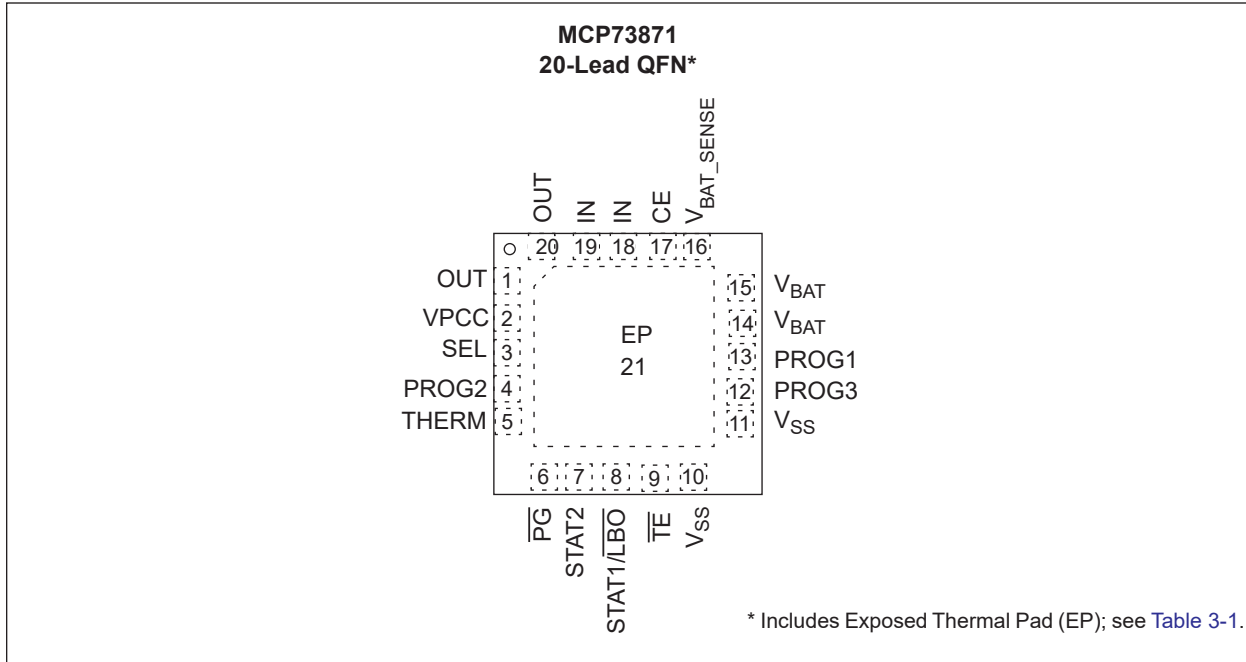
The MCP73871 device automatically obtains power for the system load from a single-cell Li-Ion battery or an input power source (AC-DC wall adapter or USB port). The MCP73871 device specifically adheres to the current drawn limits governed by the USB specification. With an AC-DC wall adapter providing power to the system, an external resistor sets the magnitude of 1A maximum charge current while supporting up to 1.8A total current for system load and battery charge current.

The MCP73871 device employs a constant current/constant voltage (CC/CV) charge algorithm with selectable charge termination point. To accommodate new and emerging battery charging requirements, the constant voltage regulation is fixed with four available options: 4.10V, 4.20V, 4.35V or 4.40V. The MCP73871 device also limits the charge current based on the die temperature during high power or high ambient conditions. This thermal regulation optimizes the charge cycle time while maintaining device reliability.

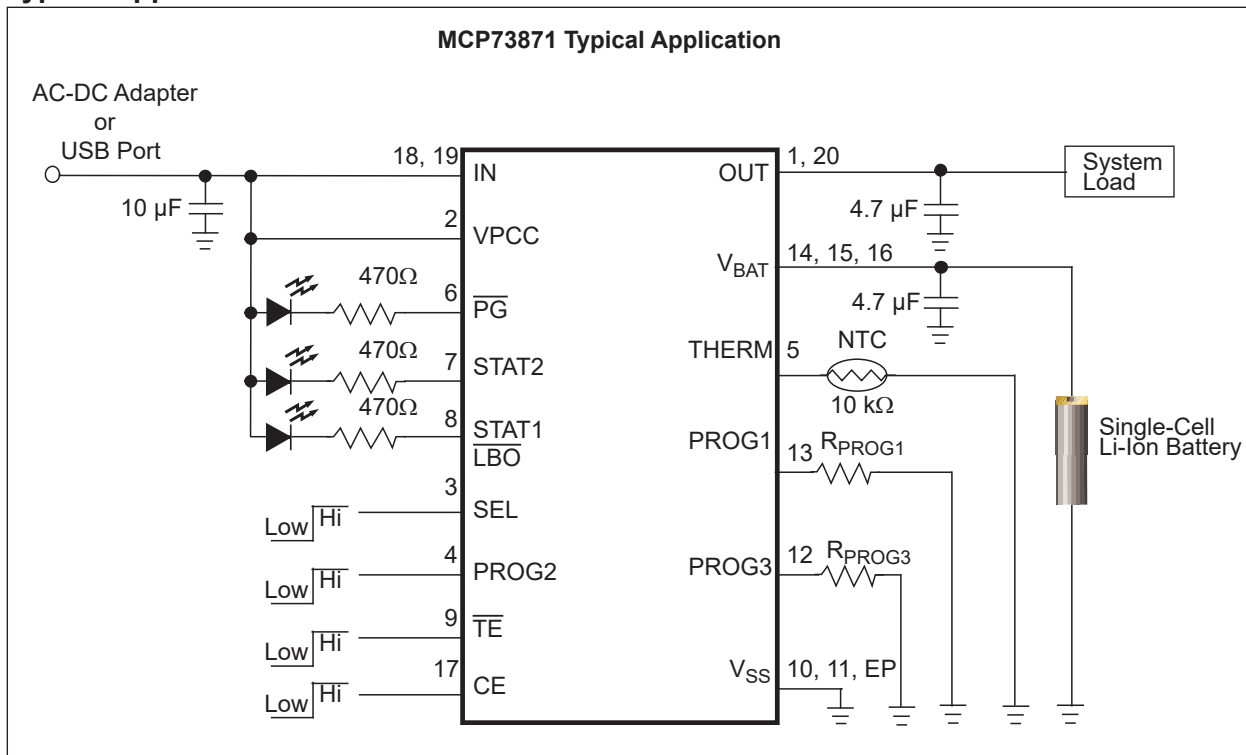
The MCP73871 device includes a low battery indicator, a power good indicator and two charge status indicators that allow for outputs with LEDs or communication with host microcontrollers. The MCP73871 device is fully specified over the ambient temperature range of  $-40^{\circ}\text{C}$  to  $+85^{\circ}\text{C}$ .

# MCP73871

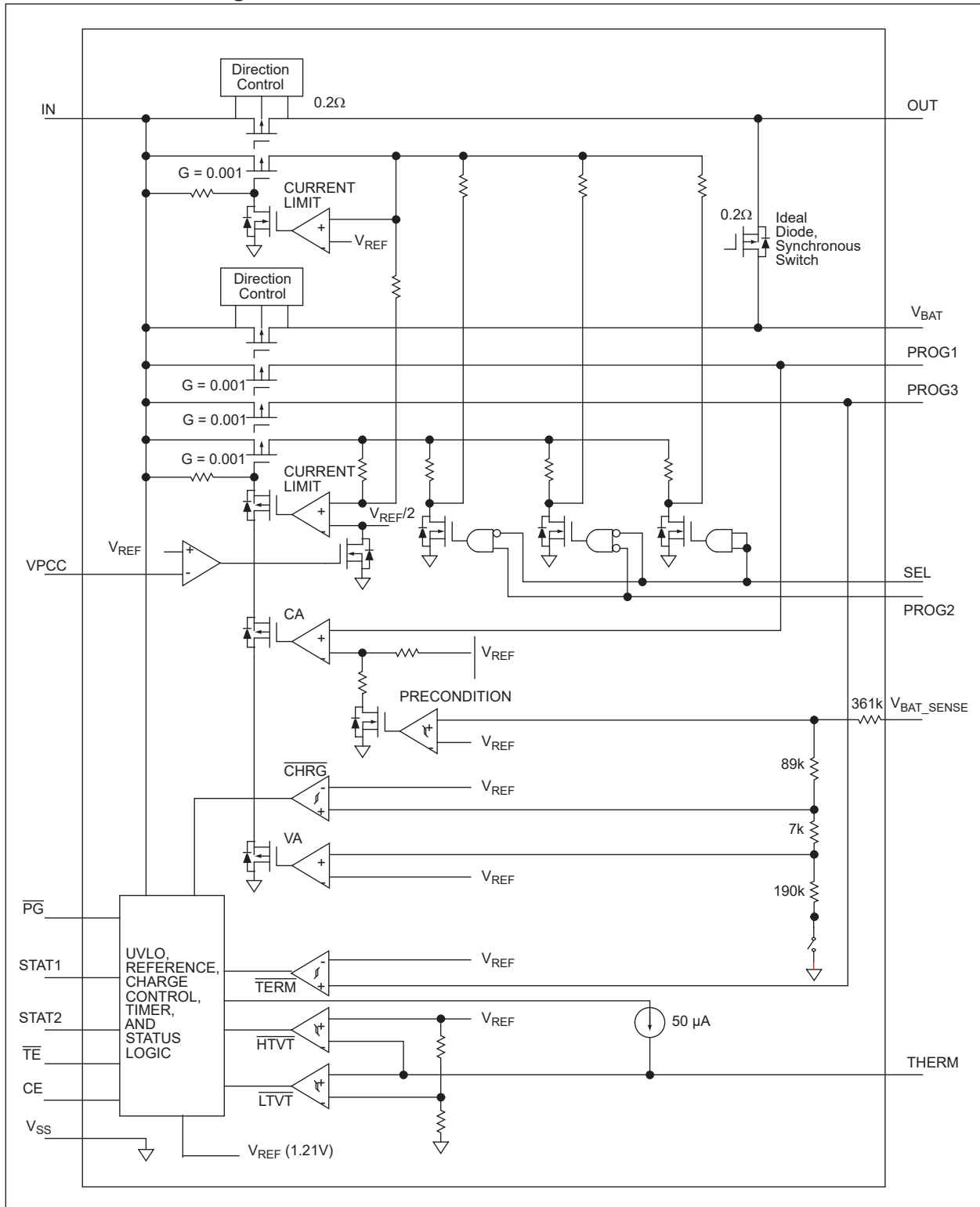
## Package Types



## Typical Application Circuit



## Functional Block Diagram



# MCP73871

---

NOTES:

## 1.0 ELECTRICAL CHARACTERISTICS

### Absolute Maximum Ratings†

$V_{IN}$  .....7.0V  
 All Inputs and Outputs w.r.t.  $V_{SS}$  ..... -0.3V to  $V_{DD}+0.3V$   
 ( $V_{DD} = V_{IN}$  or  $V_{BAT}$ )  
 Maximum Junction Temperature,  $T_J$  ..... Internally Limited  
 Storage temperature ..... -65°C to +150°C  
 ESD protection on all pins  
 Human Body Model (1.5 kΩ in Series with 100 pF) ..... ≥ 4 kV  
 Machine Model (200 pF, No Series Resistance) ..... 300V

† **Notice:** Stresses above those listed under “Maximum Ratings” may cause permanent damage to the device. This is a stress rating only and functional operation of the device at those or any other conditions above those indicated in the operational listings of this specification is not implied. Exposure to maximum rating conditions for extended periods may affect device reliability.

### DC CHARACTERISTICS

**Electrical Specifications:** Unless otherwise indicated, all limits apply for  $V_{IN} = V_{REG} + 0.3V$  to 6V,  $T_A = -40^\circ C$  to  $+85^\circ C$ . Typical values are at  $+25^\circ C$ ,  $V_{IN} = [V_{REG}(\text{typical}) + 1.0V]$

Parameters	Sym	Min	Typ	Max	Units	Conditions
<b>Supply Input</b>						
Supply Voltage	$V_{IN}$	$V_{REG} + 0.3V$	—	6	V	
Supply Current	$I_{SS}$	—	2500	3750	μA	Charging
		—	260	350	μA	Charge Complete
		—	180	300	μA	Standby
		—	28	50	μA	Shutdown ( $V_{DD} \leq V_{BAT} - 100\text{ mV}$ or $V_{DD} < V_{STOP}$ )
UVLO Start Threshold	$V_{START}$	$V_{REG} + 0.05V$	$V_{REG} + 0.15V$	$V_{REG} + 0.25V$	V	$V_{DD} = \text{Low-to-High}$
UVLO Stop Threshold	$V_{STOP}$	$V_{REG} - 0.07V$	$V_{REG} + 0.07V$	$V_{REG} + 0.17V$	V	$V_{DD} = \text{High-to-Low}$
UVLO Hysteresis	$V_{HYS}$	—	90	—	mV	
<b>Voltage Regulation (Constant Voltage Mode)</b>						
Regulated Charge Voltage	$V_{REG}$	4.080	4.10	4.121	V	$V_{DD} = [V_{REG}(\text{typical}) + 1V]$ $I_{OUT} = 10\text{ mA}$ $T_A = -5^\circ C$ to $+55^\circ C$
		4.179	4.20	4.221	V	
		4.328	4.35	4.372	V	
		4.378	4.40	4.422	V	
Regulated Charge Voltage Tolerance	$V_{RTOL}$	-0.5	—	+0.5	%	$T_A = +25^\circ C$
		-0.75	—	+0.75	%	$T_A = -5^\circ C$ to $+55^\circ C$
Line Regulation	$ \frac{\Delta V_{BAT}/V_{BAT}}{\Delta V_{DD}} $	—	0.08	0.20	%/V	$V_{DD} = [V_{REG}(\text{typical}) + 1V]$ to 6V $I_{OUT} = 10\text{ mA}$
Load Regulation	$ \Delta V_{BAT}/V_{BAT} $	—	0.08	0.18	%	$I_{OUT} = 10\text{ mA}$ to 150 mA $V_{DD} = [V_{REG}(\text{typical}) + 1V]$
Supply Ripple Attenuation	PSRR	—	-47	—	dB	$I_{OUT} = 10\text{ mA}$ , 1 kHz
		—	-40	—	dB	$I_{OUT} = 10\text{ mA}$ , 10 kHz

**Note 1:** The value is ensured by design and not production tested.

**Note 2:** The maximum available charge current is also limited by the value set at PROG1 input.

# MCP73871

## DC CHARACTERISTICS (CONTINUED)

**Electrical Specifications:** Unless otherwise indicated, all limits apply for  $V_{IN} = V_{REG} + 0.3V$  to  $6V$ ,  $T_A = -40^{\circ}C$  to  $+85^{\circ}C$ . Typical values are at  $+25^{\circ}C$ ,  $V_{IN} = [V_{REG} \text{ (typical)} + 1.0V]$

Parameters	Sym	Min	Typ	Max	Units	Conditions
<b>Current Regulation (Fast Charge Constant Current Mode)</b>						
AC-Adapter Fast Charge Current	$I_{REG}$	90	100	110	mA	PROG1 = 10 k $\Omega$ , $T_A = -5^{\circ}C$ to $+55^{\circ}C$ , SEL = High
		900	1000	1100	mA	PROG1 = 1 k $\Omega$ , $T_A = -5^{\circ}C$ to $+55^{\circ}C$ , SEL = High
USB Fast Charge Current	$I_{REG}$	80	90	100	mA	PROG2 = Low, SEL = Low, <b>(Note 2)</b> $T_A = -5^{\circ}C$ to $+55^{\circ}C$
		400	450	500	mA	PROG2 = High, SEL = Low, <b>(Note 2)</b> $T_A = -5^{\circ}C$ to $+55^{\circ}C$
<b>Input Current Limit Control (ICLC)</b>						
USB-Port Supply Current Limit	$I_{LIMIT\_USB}$	80	90	100	mA	PROG2 = Low, SEL = Low $T_A = -5^{\circ}C$ to $+55^{\circ}C$
		400	450	500	mA	PROG2 = High, SEL = Low $T_A = -5^{\circ}C$ to $+55^{\circ}C$
AC-DC Adapter Current Limit	$I_{LIMIT\_AC}$	1500	1650	1800	mA	SEL = High, $T_A = -5^{\circ}C$ to $+55^{\circ}C$
<b>Voltage Proportional Charge Control (VPCC - Input Voltage Regulation)</b>						
VPCC Input Threshold	$V_{VPCC}$	—	1.23	—	V	$I_{OUT} = 10 \text{ mA}$ $T_A = -5^{\circ}C$ to $+55^{\circ}C$
VPCC Input Threshold Tolerance	$V_{RTOL}$	-3	—	+3	%	
Input Leakage Current	$I_{LK}$	—	0.01	1	$\mu\text{A}$	$V_{VPCC} = V_{DD}$
<b>Precondition Current Regulation (Trickle Charge Constant Current Mode)</b>						
Precondition Current Ratio	$I_{PREG}/I_{REG}$	7.5	10	12.5	%	PROG1 = 1.0 k $\Omega$ to 10 k $\Omega$ $T_A = -5^{\circ}C$ to $+55^{\circ}C$
Precondition Current Threshold Ratio	$V_{PTH}/V_{REG}$	69	72	75	%	$V_{BAT}$ Low-to-High
Precondition Hysteresis	$V_{PHYS}$	—	105	—	mV	$V_{BAT}$ High-to-Low
<b>Automatic Charge Termination Set Point</b>						
Charge Termination Current Ratio	$I_{TERM}$	75	100	125	mA	PROG3 = 10 k $\Omega$ $T_A = -5^{\circ}C$ to $+55^{\circ}C$
		7.5	10	12.5	mA	PROG3 = 100 k $\Omega$ $T_A = -5^{\circ}C$ to $+55^{\circ}C$
<b>Automatic Recharge</b>						
Recharge Voltage Threshold Ratio	$V_{RTH}$	$V_{REG} - 0.21V$	$V_{REG} - 0.15V$	$V_{REG} - 0.09V$	V	$V_{BAT}$ High-to-Low
<b>IN-to-OUT Pass Transistor ON-Resistance</b>						
ON-Resistance	$R_{DS\_ON}$	—	200	—	m $\Omega$	$V_{DD} = 4.5V$ , $T_J = 105^{\circ}C$

**Note 1:** The value is ensured by design and not production tested.

**Note 2:** The maximum available charge current is also limited by the value set at PROG1 input.

## DC CHARACTERISTICS (CONTINUED)

**Electrical Specifications:** Unless otherwise indicated, all limits apply for  $V_{IN} = V_{REG} + 0.3V$  to  $6V$ ,  $T_A = -40^{\circ}C$  to  $+85^{\circ}C$ . Typical values are at  $+25^{\circ}C$ ,  $V_{IN} = [V_{REG} \text{ (typical)} + 1.0V]$

Parameters	Sym	Min	Typ	Max	Units	Conditions
<b>Charge Transistor ON-Resistance</b>						
ON-Resistance	$R_{DS_{ON\_}}$	—	200	—	m $\Omega$	$V_{DD} = 4.5V$ , $T_J = 105^{\circ}C$
<b>BAT-to-OUT Pass Transistor ON-Resistance</b>						
ON-Resistance	$R_{DS_{ON}}$	—	200	—	m $\Omega$	$V_{DD} = 4.5V$ , $T_J = 105^{\circ}C$
<b>Battery Discharge Current</b>						
Output Reverse Leakage Current	$I_{DISCHARGE}$	—	30	40	$\mu A$	Shutdown ( $V_{BAT} < V_{DD} < V_{UVLO}$ )
		—	30	40	$\mu A$	Shutdown ( $0 < V_{DD} \leq V_{BAT}$ )
		—	30	40	$\mu A$	$V_{BAT} = \text{Power Out, No Load}$
		—	-6	-13	$\mu A$	Charge Complete
<b>Status Indicators - STAT1 (LBO), STAT2, PG</b>						
Sink Current	$I_{SINK}$	—	16	35	mA	
Low Output Voltage	$V_{OL}$	—	0.4	1	V	$I_{SINK} = 4 \text{ mA}$
Input Leakage Current	$I_{LK}$	—	0.01	1	$\mu A$	High Impedance, $V_{DD}$ on pin
<b>Low Battery Indicator (LBO)</b>						
Low Battery Detection Threshold	$V_{LBO}$	—	Disable	—		$V_{BAT} > V_{IN}$ , $\overline{PG} = \text{Hi-Z}$ $T_A = -5^{\circ}C$ to $+55^{\circ}C$
		2.85	3.0	3.15	V	
		2.95	3.1	3.25	V	
		3.05	3.2	3.35	V	
Low Battery Detection Hysteresis	$V_{LBO\_HYS}$	—	150	—	mV	$V_{BAT}$ Low-to-High
<b>PROG1 Input (PROG1)</b>						
Charge Impedance Range	$R_{PROG}$	1	—	20	k $\Omega$	
<b>PROG3 Input (PROG3)</b>						
Termination Impedance Range	$R_{PROG}$	5	—	100	k $\Omega$	
<b>PROG2 Input (PROG2)</b>						
Input High Voltage Level	$V_{IH}$	1.8	—	—	V	
Input Low Voltage Level	$V_{IL}$	—	—	0.8	V	
Input Leakage Current	$I_{LK}$	—	0.01	1	$\mu A$	$V_{PROG2} = V_{DD}$
<b>Timer Enable (TE)</b>						
Input High Voltage Level	$V_{IH}$	1.8	—	—	V	<b>Note 1</b>
Input Low Voltage Level	$V_{IL}$	—	—	0.8	V	<b>Note 1</b>
Input Leakage Current	$I_{LK}$	—	0.01	1	$\mu A$	$V_{TE} = V_{DD}$

**Note 1:** The value is ensured by design and not production tested.

**Note 2:** The maximum available charge current is also limited by the value set at PROG1 input.

# MCP73871

## DC CHARACTERISTICS (CONTINUED)

**Electrical Specifications:** Unless otherwise indicated, all limits apply for  $V_{IN} = V_{REG} + 0.3V$  to  $6V$ ,  $T_A = -40^{\circ}C$  to  $+85^{\circ}C$ . Typical values are at  $+25^{\circ}C$ ,  $V_{IN} = [V_{REG} \text{ (typical)} + 1.0V]$

Parameters	Sym	Min	Typ	Max	Units	Conditions
<b>Chip Enable (CE)</b>						
Input High Voltage Level	$V_{IH}$	1.8	—	—	V	
Input Low Voltage Level	$V_{IL}$	—	—	0.8	V	
Input Leakage Current	$I_{LK}$	—	0.01	1	$\mu A$	$V_{CE} = V_{DD}$
<b>Input Source Selection (SEL)</b>						
Input High Voltage Level	$V_{IH}$	1.8	—	—	V	
Input Low Voltage Level	$V_{IL}$	—	—	0.8	V	
Input Leakage Current	$I_{LK}$	—	0.01	1	$\mu A$	$V_{SEL} = V_{DD}$
<b>Thermistor Bias</b>						
Thermistor Current Source	$I_{THERM}$	47	50	53	$\mu A$	$2 \text{ k}\Omega < R_{THERM} < 50 \text{ k}\Omega$
<b>Thermistor Comparator</b>						
Upper Trip Threshold	$V_{T1}$	1.20	1.24	1.26	V	$V_{T1}$ Low-to-High
Upper Trip Point Hysteresis	$V_{T1HYS}$	—	-40	—	mV	
Lower Trip Threshold	$V_{T2}$	0.23	0.25	0.27	V	$V_{T2}$ High-to-Low
Lower Trip Point Hysteresis	$V_{T2HYS}$	—	40	—	mV	
<b>Thermal Shutdown</b>						
Die Temperature	$T_{SD}$	—	150	—	$^{\circ}C$	
Die Temperature Hysteresis	$T_{SDHYS}$	—	10	—	$^{\circ}C$	

- Note** 1: The value is ensured by design and not production tested.  
 2: The maximum available charge current is also limited by the value set at PROG1 input.



## AC CHARACTERISTICS

<b>Electrical Specifications:</b> Unless otherwise indicated, all limits apply for $V_{IN} = 4.6V$ to $6V$ . Typical values are at $+25^{\circ}C$ , $V_{DD} = [V_{REG}(\text{typical}) + 1.0V]$						
Parameters	Sym	Min	Typ	Max	Units	Conditions
UVLO Start Delay	$t_{START}$	—	—	5	ms	$V_{DD}$ Low-to-High
<b>Current Regulation</b>						
Transition Time Out of Precondition	$t_{DELAY}$	—	—	10	ms	$V_{BAT} < V_{PTH}$ to $V_{BAT} > V_{PTH}$
Current Rise Time Out of Precondition	$t_{RISE}$	—	—	10	ms	$I_{OUT}$ Rising to 90% of $I_{REG}$
Precondition Comparator Filter Time	$t_{PRECON}$	0.4	1.3	3.2	ms	Average $V_{BAT}$ Rise/Fall
Termination Comparator Filter Time	$t_{TERM}$	0.4	1.3	3.2	ms	Average $I_{OUT}$ Falling
Charge Comparator Filter Time	$t_{CHARGE}$	0.4	1.3	3.2	ms	Average $V_{BAT}$ Falling
Thermistor Comparator Filter Time	$t_{THERM}$	0.4	1.3	3.2	ms	Average THERM Rise/Fall
<b>Elapsed Timer</b>						
Elapsed Timer Period	$t_{ELAPSED}$	—	0	—	Hours	
		3.6	4.0	4.4	Hours	
		5.4	6.0	6.6	Hours	
		7.2	8.0	8.8	Hours	
<b>Status Indicators</b>						
Status Output Turn-off	$t_{OFF}$	—	—	500	$\mu s$	$I_{SINK} = 1\text{ mA to }0\text{ mA}$
Status Output Turn-on	$t_{ON}$	—	—	500	$\mu s$	$I_{SINK} = 0\text{ mA to }1\text{ mA}$

**Note 1:** Internal safety timer is tested based on internal oscillator frequency measurement.

## TEMPERATURE SPECIFICATIONS

<b>Electrical Specifications:</b> Unless otherwise indicated, all limits apply for $V_{IN} = 4.6V$ to $6V$ . Typical values are at $+25^{\circ}C$ , $V_{DD} = [V_{REG}(\text{typical}) + 1.0V]$						
Parameters	Sym	Min	Typ	Max	Units	Conditions
<b>Temperature Ranges</b>						
Specified Temperature Range	$T_A$	-40	—	+85	$^{\circ}C$	
Operating Temperature Range	$T_J$	-40	—	+125	$^{\circ}C$	
Storage Temperature Range	$T_A$	-65	—	+150	$^{\circ}C$	
<b>Thermal Package Resistances</b>						
Thermal Resistance, 20LD-QFN, 4x4	$\theta_{JA}$	—	50	—	$^{\circ}C/W$	4-Layer JC51-7 Standard Board, Natural Convection
	$\theta_{JC}$	—	8	—		

# MCP73871

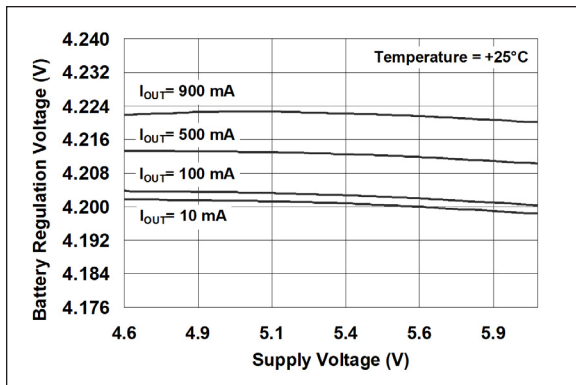
---

NOTES:

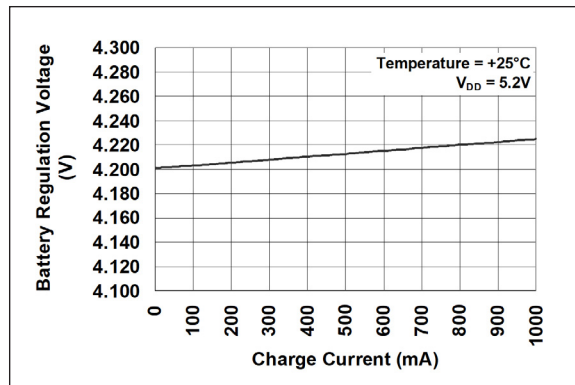
## 2.0 TYPICAL PERFORMANCE CURVES

**Note:** The graphs and tables provided following this note are a statistical summary based on a limited number of samples and are provided for informational purposes only. The performance characteristics listed herein are not tested or guaranteed. In some graphs or tables, the data presented may be outside the specified operating range (e.g., outside specified power supply range) and therefore outside the warranted range.

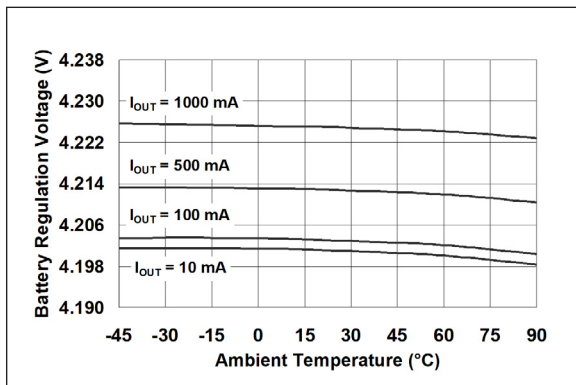
**Note:** Unless otherwise indicated,  $V_{IN} = [V_{REG}(\text{typical}) + 1V]$ ,  $I_{OUT} = 10 \text{ mA}$  and  $T_A = +25^\circ\text{C}$ , Constant Voltage mode.



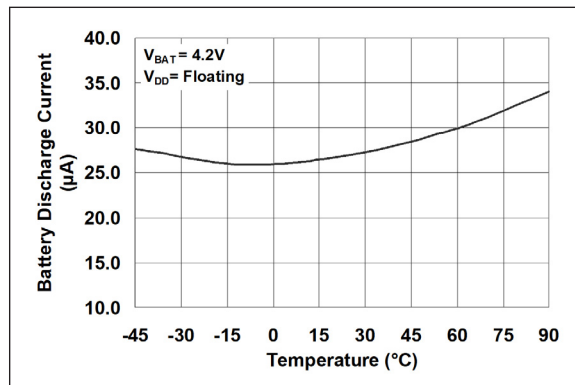
**FIGURE 2-1:** Battery Regulation Voltage ( $V_{BAT}$ ) vs. Supply Voltage ( $V_{DD}$ ).



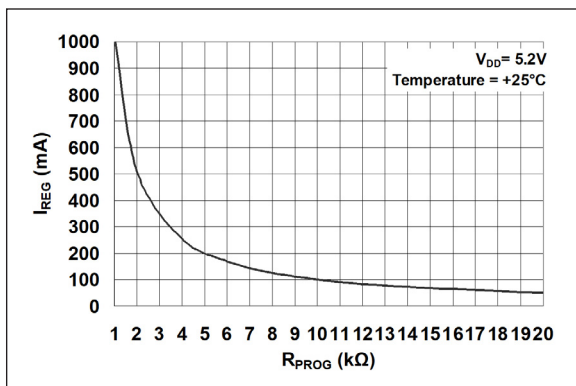
**FIGURE 2-4:** Charge Current ( $I_{OUT}$ ) vs. Battery Regulation Voltage ( $V_{BAT}$ ).



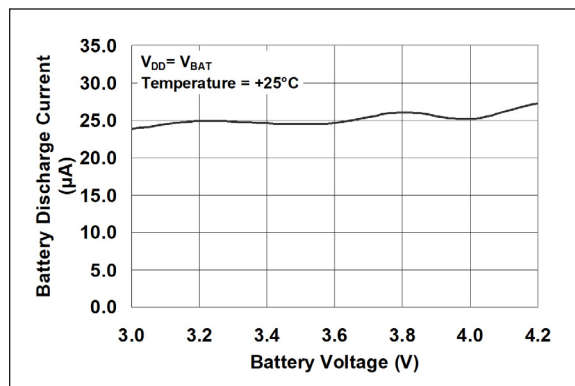
**FIGURE 2-2:** Battery Regulation Voltage ( $V_{BAT}$ ) vs. Ambient Temperature ( $T_A$ ).



**FIGURE 2-5:** Output Leakage Current ( $I_{DISCHARGE}$ ) vs. Ambient Temperature ( $T_A$ ).



**FIGURE 2-3:** Charge Current ( $I_{OUT}$ ) vs. Programming Resistor ( $R_{PROG}$ ).



**FIGURE 2-6:** Output Leakage Current ( $I_{DISCHARGE}$ ) vs. Battery Regulation Voltage ( $V_{BAT}$ ).

# MCP73871

Note: Unless otherwise indicated,  $V_{IN} = [V_{REG}(\text{typical}) + 1V]$ ,  $I_{OUT} = 10 \text{ mA}$  and  $T_A = +25^\circ\text{C}$ , Constant Voltage mode.

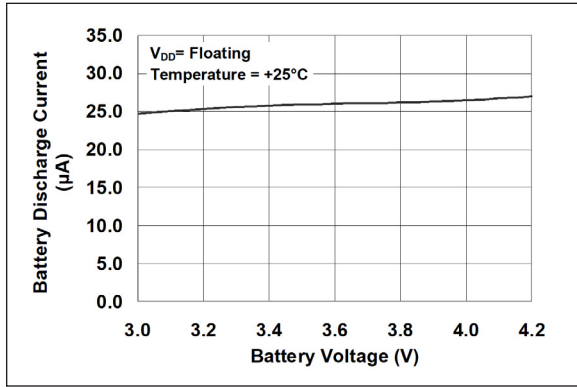


FIGURE 2-7: Output Leakage Current ( $I_{DISCHARGE}$ ) vs. Battery Voltage ( $V_{BAT}$ ).

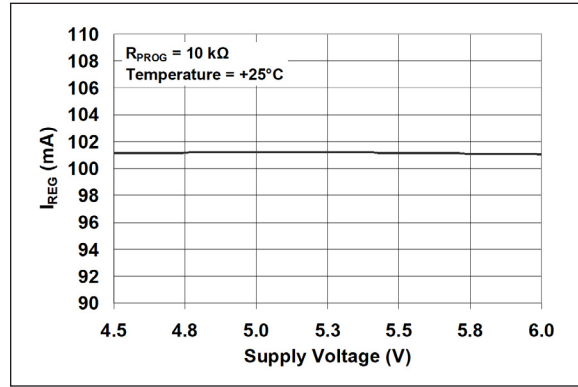


FIGURE 2-10: Charge Current ( $I_{OUT}$ ) vs. Supply Voltage ( $V_{DD}$ ).

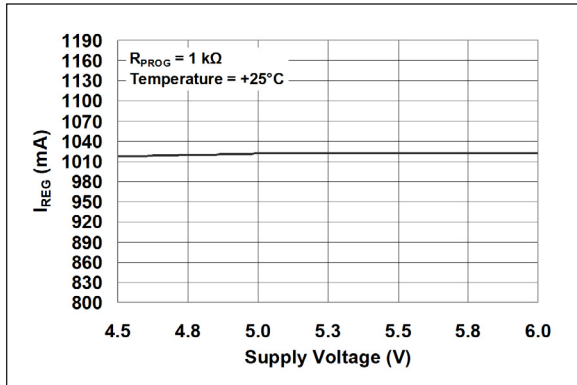


FIGURE 2-8: Charge Current ( $I_{OUT}$ ) vs. Supply Voltage ( $V_{DD}$ ).

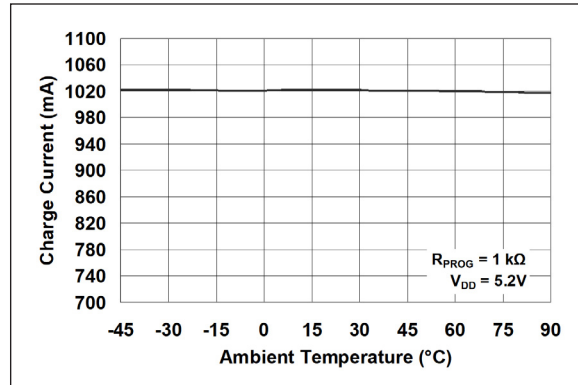


FIGURE 2-11: Charge Current ( $I_{OUT}$ ) vs. Ambient Temperature ( $T_A$ ).

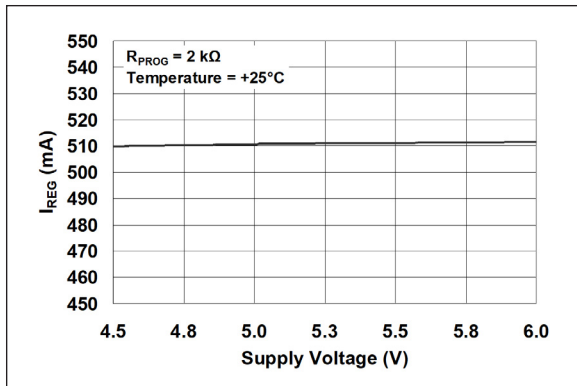


FIGURE 2-9: Charge Current ( $I_{OUT}$ ) vs. Supply Voltage ( $V_{DD}$ ).

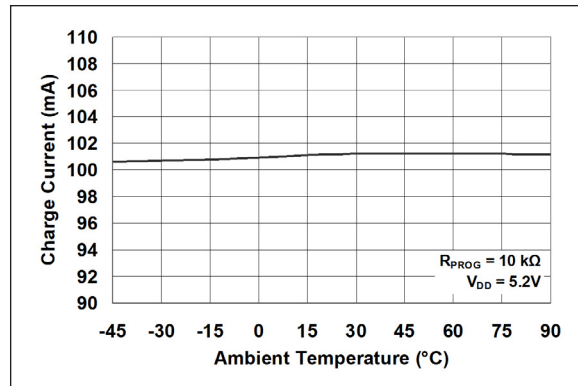
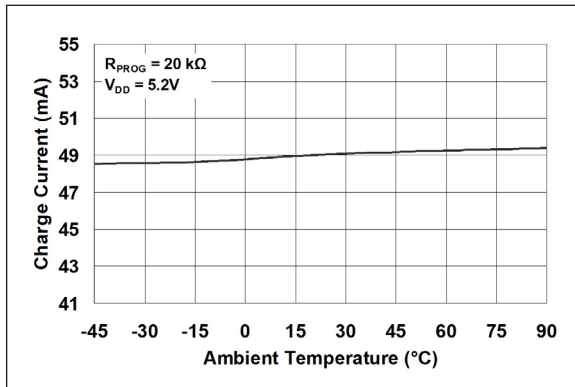
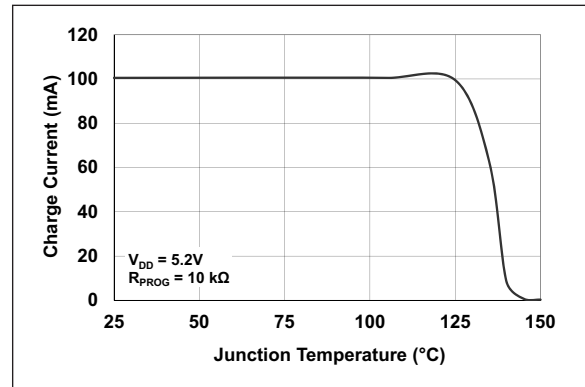


FIGURE 2-12: Charge Current ( $I_{OUT}$ ) vs. Ambient Temperature ( $T_A$ ).

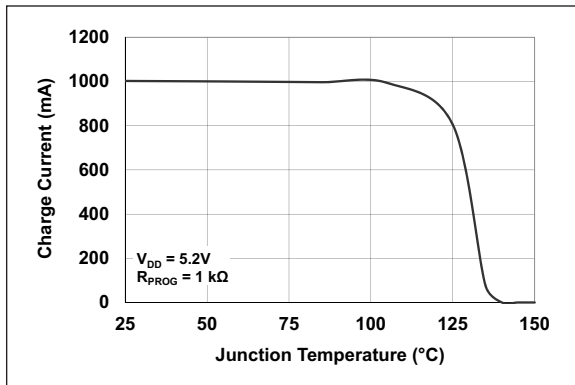
**Note:** Unless otherwise indicated,  $V_{IN} = [V_{REG}(\text{typical}) + 1V]$ ,  $I_{OUT} = 10 \text{ mA}$  and  $T_A = +25^\circ\text{C}$ , Constant Voltage mode.



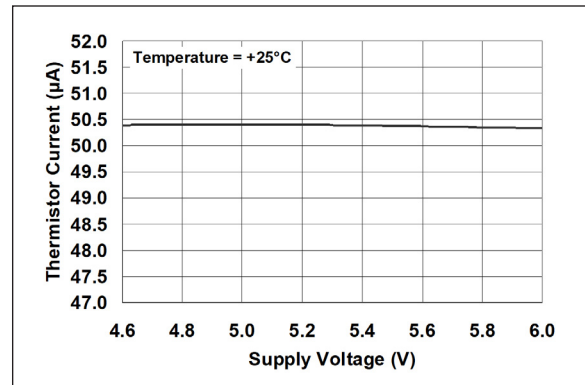
**FIGURE 2-13:** Charge Current ( $I_{OUT}$ ) vs. Ambient Temperature ( $T_A$ ).



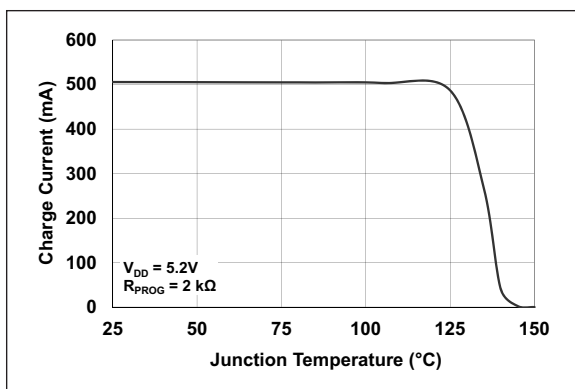
**FIGURE 2-16:** Charge Current ( $I_{OUT}$ ) vs. Junction Temperature ( $T_J$ ).



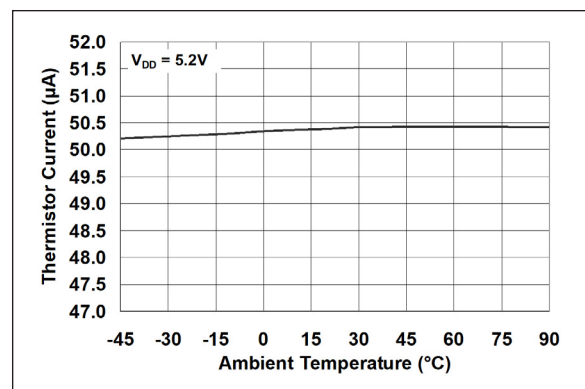
**FIGURE 2-14:** Charge Current ( $I_{OUT}$ ) vs. Junction Temperature ( $T_J$ ).



**FIGURE 2-17:** Thermistor Current ( $I_{THERM}$ ) vs. Supply Voltage ( $V_{DD}$ ).



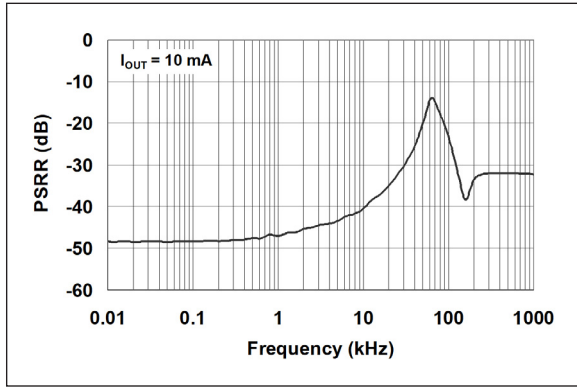
**FIGURE 2-15:** Charge Current ( $I_{OUT}$ ) vs. Junction Temperature ( $T_J$ ).



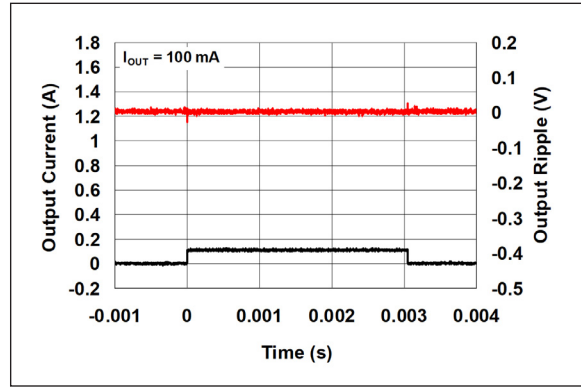
**FIGURE 2-18:** Thermistor Current ( $I_{THERM}$ ) vs. Ambient Temperature ( $T_A$ ).

# MCP73871

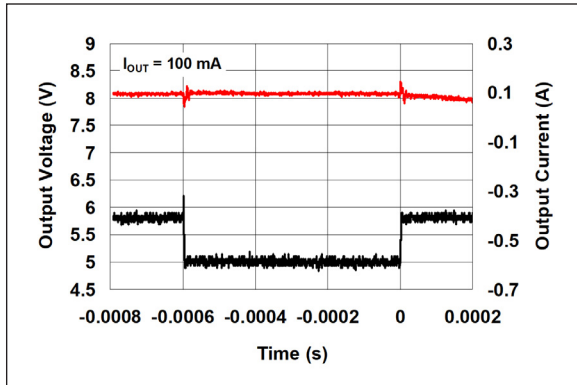
Note: Unless otherwise indicated,  $V_{IN} = [V_{REG}(typical) + 1V]$ ,  $I_{OUT} = 10\text{ mA}$  and  $T_A = +25^\circ\text{C}$ , Constant Voltage mode.



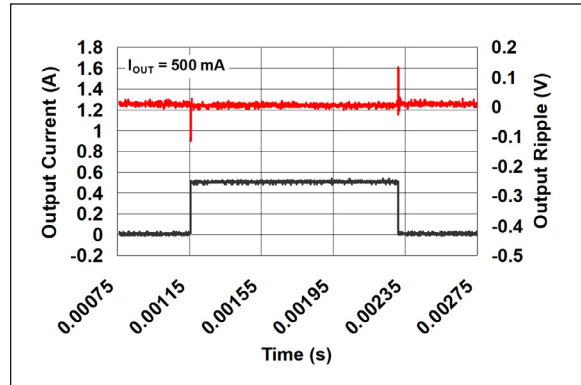
**FIGURE 2-19:** Power Supply Ripple Rejection (PSRR).



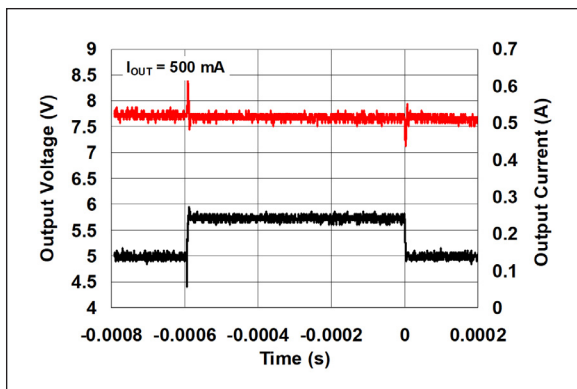
**FIGURE 2-22:** Load Transient Response.  $I_{OUT} = 100\text{ mA}$ .



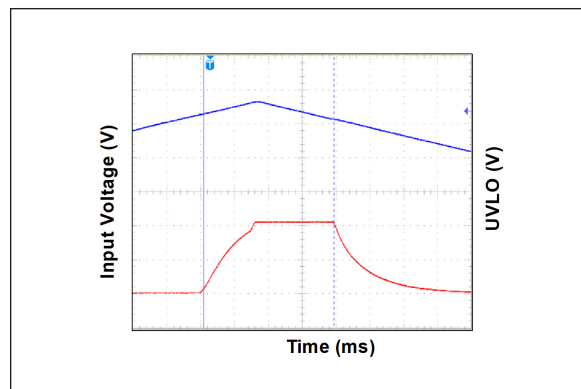
**FIGURE 2-20:** Line Transient Response.  $I_{OUT} = 100\text{ mA}$ .



**FIGURE 2-23:** Load Transient Response.  $I_{OUT} = 500\text{ mA}$ .

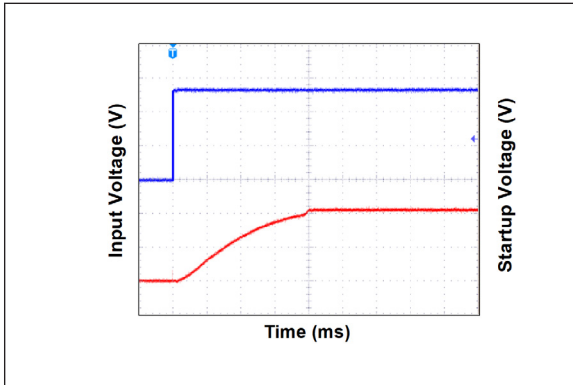


**FIGURE 2-21:** Line Transient Response.  $I_{OUT} = 500\text{ mA}$ .

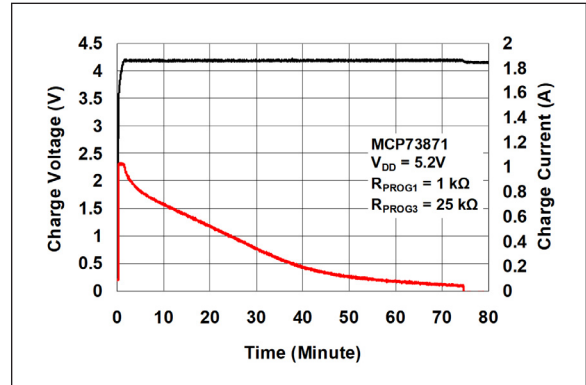


**FIGURE 2-24:** Undervoltage Lockout.

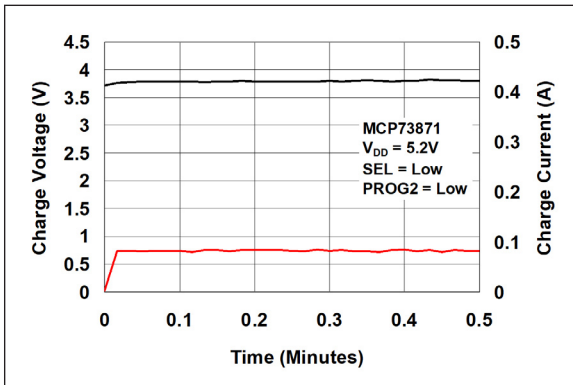
**Note:** Unless otherwise indicated,  $V_{IN} = [V_{REG}(\text{typical}) + 1V]$ ,  $I_{OUT} = 10 \text{ mA}$  and  $T_A = +25^\circ\text{C}$ , Constant Voltage mode.



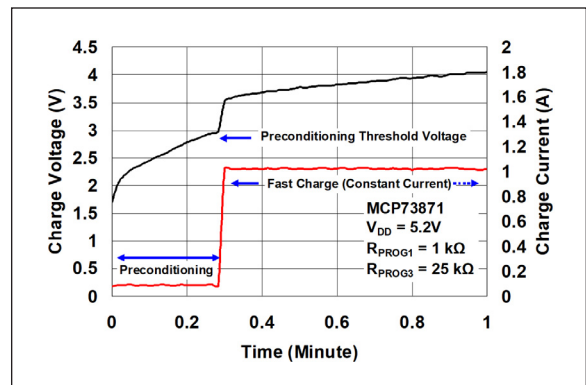
**FIGURE 2-25:** Start-up Delay.



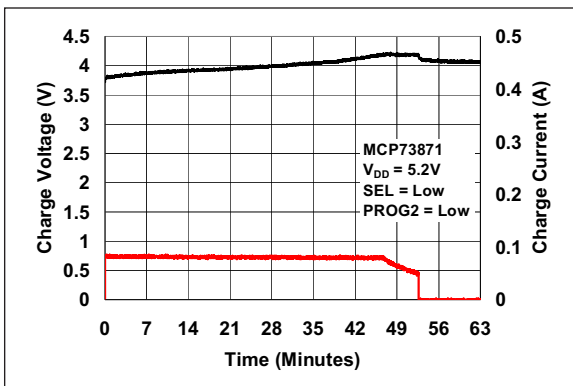
**FIGURE 2-28:** Complete Charge Cycle (1000 mAh Li-Ion Battery).



**FIGURE 2-26:** Start Charge Cycle (130 mAh Li-Ion Battery).



**FIGURE 2-29:** Typical Charge Profile in Preconditioning (1000 mAh Battery).



**FIGURE 2-27:** Complete Charge Cycle (130 mAh Li-Ion Battery).

# MCP73871

---

NOTES:



### 3.0 PIN DESCRIPTION

The descriptions of the pins are listed in Table 3-1.

**TABLE 3-1: PIN FUNCTION TABLE**

Pin Number	Symbol	I/O	Function
1, 20	OUT	O	System Output Terminal
2	VPCC	I	Voltage proportional charge control
3	SEL	I	Input type selection (low for USB port, high for AC-DC adapter)
4	PROG2	I	USB port input current limit selection when SEL = Low (Low = 100 mA, High = 500 mA)
5	THERM	I/O	Thermistor monitoring input and bias current
6	$\overline{\text{PG}}$	O	Power Good Status Output (Open-Drain)
7	STAT2	O	Charge Status Output 2 (Open-Drain)
8	STAT1/ $\overline{\text{LBO}}$	O	Charge Status Output 1 (Open-Drain). Low battery output indicator when $V_{\text{BAT}} > V_{\text{IN}}$
9	$\overline{\text{TE}}$	I	Timer Enable; Enables Safety Timer when active-low
10, 11, EP	$V_{\text{SS}}$	—	Battery Management 0V Reference. EP (Exposed Thermal Pad). There is an internal electrical connection between the exposed thermal pad and $V_{\text{SS}}$ . The EP must be connected to the same potential as the $V_{\text{SS}}$ pin on the Printed Circuit Board (PCB)
12	PROG3	I/O	Termination set point for both AC-DC adapter and USB port
13	PROG1	I/O	Fast charge current regulation setting with SEL = high. Preconditioning set point for both USB port and AC-DC adapter
14, 15	$V_{\text{BAT}}$	I/O	Battery Positive Input and Output connection
16	$V_{\text{BAT\_SENSE}}$	I/O	Battery Voltage Sense
17	CE	I	Device Charge Enable; Enabled when CE = high
18, 19	IN	I	Power Supply Input
<b>Legend:</b> I = Input, O = Output, I/O = Input/Output			

**Note:** To ensure proper operation, the input pins must not allow floating and should always tie to either high or low.

#### 3.1 Power Supply Input (IN)

A supply voltage of  $V_{\text{REG}} + 0.3\text{V}$  to 6V is recommended. Bypass to  $V_{\text{SS}}$  with a minimum of 4.7  $\mu\text{F}$ .

#### 3.2 System Output Terminal (OUT)

The MCP73871 device powers the system via output terminals while independently charging the battery. This feature reduces the charge and discharge cycles on the battery, allowing proper charge termination and the system to run with an absent or defective battery pack. It also gives the system priority on input power, allowing the system to power-up with deeply depleted battery packs. Bypass to  $V_{\text{SS}}$  with a minimum of 4.7  $\mu\text{F}$  is recommended.

#### 3.3 Voltage Proportional Charge Control (VPCC)

If the voltage on the IN pin drops to a preset value determined by the threshold established at the VPCC input due to a limited amount of input current or input source impedance, the battery charging current is reduced. If possible, further demand from the system is supported by the battery. To enable this feature, simply supply 1.23V or greater to the VPCC pin. This feature can be disabled by connecting the VPCC pin to IN.

For example, a system is designed with a 5.5V rated DC power supply with  $\pm 0.5\text{V}$  tolerance. The worst condition of 5V is selected, which is used to calculate the VPCC supply voltage with divider.

# MCP73871

The voltage divider equation is shown below:

## EQUATION 3-1:

$$V_{VPCC} = \left( \frac{R_2}{R_1 + R_2} \right) \times V_{IN} = 1.23V$$
$$1.23V = \left( \frac{110k\Omega}{110k\Omega + R_1} \right) \times 5V$$
$$R_1 = 337.2k\Omega$$

The calculated  $R_1$  equals 337.2 k $\Omega$  when 110 k $\Omega$  is selected for  $R_2$ . The 330 k $\Omega$  resistor is selected for  $R_1$  to build the voltage divider for VPCC.

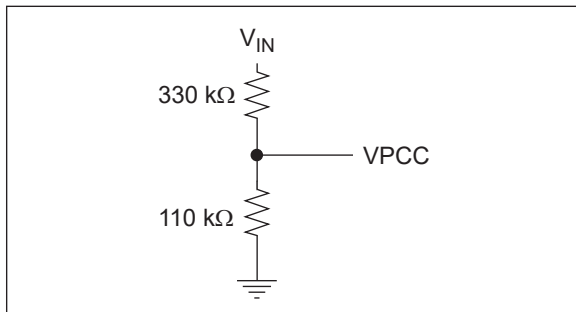


FIGURE 3-1: Voltage Divider Example.

### 3.4 Input Source Type Selection (SEL)

The input source type selection (SEL) pin is used to select the input power source for the input current limit control feature. With the SEL input high, the MCP73871 device is capable of providing 1.65 (typical) total amperes to be shared by the system load and Li-Ion battery charging. The MCP73871 device limits the input current up to 1.8A. When SEL active-low, the input source is designed to provide system power and Li-Ion battery charging from a USB Port input while adhering to the current limits governed by the USB specification.

### 3.5 Battery Management 0V Reference ( $V_{SS}$ )

Connect to the negative terminal of the battery, system load and input supply.

### 3.6 Battery Charge Control Output ( $V_{BAT}$ )

Connect to positive terminal of the Li-Ion/Li-Polymer battery. Bypass to  $V_{SS}$  with a minimum of 4.7  $\mu$ F to ensure loop stability when the battery is disconnected.

### 3.7 Battery Voltage Sense ( $V_{BAT\_SENSE}$ )

Connect to the positive terminal of the battery. A precision internal voltage sense regulates the final voltage on this pin to  $V_{REG}$ .

### 3.8 Charge Current Regulation Set (PROG1)

The maximum constant charge current is set by placing a resistor from PROG1 to  $V_{SS}$ . PROG1 sets the maximum constant charge current for both the AC-DC adapter and USB port. However, the actual charge current is based on the input source type and the system load requirement.

### 3.9 USB-Port Current Regulation Set (PROG2)

The MCP73871 device USB-Port current regulation set input (PROG2) is a digital input selection. A logic Low selects a one unit load input current from the USB port (100 mA) while a logic high selects a five unit load input current from the USB port (500 mA).

### 3.10 Charge Status Output 1 (STAT1)

STAT1 is an open-drain logic output for connection to an LED for charge status indication. Alternatively, a pull-up resistor can be applied for interfacing to a host microcontroller. Refer to Table 5-1 for a summary of the status output during a charge cycle.

### 3.11 Charge Status Output 2 (STAT2)

STAT2 is an open-drain logic output for connection to an LED for charge status indication. Alternatively, a pull up resistor can be applied for interfacing to a host microcontroller. Refer to Table 5-1 for a summary of the status output during a charge cycle.

### 3.12 Power Good ( $\overline{PG}$ )

The power good ( $\overline{PG}$ ) is an open-drain logic output for input power supply indication. The  $\overline{PG}$  output is low whenever the input to the MCP73871 device is above the UVLO threshold and greater than the battery voltage. The  $\overline{PG}$  output may be used with an LED or as an interface to a host microcontroller to signal when an input power source is supplying power to the system and the battery. Refer to Table 5-1 for a summary of the status output during a charge cycle.

### 3.13 Low Battery Output ( $\overline{\text{LBO}}$ )

STAT1 also serves as low battery output (LBO) if the selected MCP73871 is equipped with this feature. It provides an indication to the system or end user when the Li-Ion battery voltage level is low. The  $\overline{\text{LBO}}$  feature is enabled when the system is running from the Li-Ion battery. The  $\overline{\text{LBO}}$  output may be used with an LED or as an interface to a host microcontroller to signal when the system is operating from the battery and the battery is running low on charge. Refer to [Table 5-1](#) for a summary of the status output during a charge cycle. The third character of the operational output options code indicates the LBO threshold: A = disable, B = 3.0V, C = 3.1V and D = 3.2V.

### 3.14 Timer Enable ( $\overline{\text{TE}}$ )

The Timer Enable ( $\overline{\text{TE}}$ ) feature is used to enable or disable the internal timer. A low signal enables and a high signal disables the internal timer on this pin. The  $\overline{\text{TE}}$  input can be used to disable the timer when the system load is substantially limiting the available supply current to charge the battery. The  $\overline{\text{TE}}$  input is compatible with 1.8V logic. The  $\overline{\text{TE}}$  signal asserted low will stop the timer but not Reset it. The timer can be reset by cycling the CE pin. The second character of the operational output options code indicates the Timer interval: A = disable, B = 4 hours, C = 6 hours and D = 8 hours.

**Note:** The built-in safety timer is available for the following options: 4 HR, 6 HR and 8 HR.

### 3.15 Battery Temperature Monitor (THERM)

The MCP73871 device continuously monitors battery temperature during a charge cycle by measuring the voltage between the THERM and  $V_{SS}$  pins. An internal 50  $\mu\text{A}$  current source provides the bias for most common 10 k $\Omega$  Negative Temperature Coefficient (NTC) thermistors. The MCP73871 device compares the voltage at the THERM pin to factory set thresholds of 1.24V and 0.25V, typically. Once a voltage outside the thresholds is detected during a charge cycle, the MCP73871 device immediately suspends the charge cycle. The charge cycle resumes when the voltage at the THERM pin returns to the normal range. The charge temperature window can be set by placing fixed value resistors in series-parallel with a thermistor. Refer to [Section 6.0 “Applications”](#) for calculations of resistance values.

### 3.16 Charge Enable (CE)

With the CE input Low, the Li-Ion battery charger feature of the MCP73871 is disabled. The charger feature is enabled when CE is active-high. Allowing the CE pin to float during the charge cycle may cause system instability. The CE input is compatible with 1.8V logic. Refer to [Section 6.0 “Applications”](#) for various applications in designing with CE features.

### 3.17 Exposed Thermal Pad (EP)

An internal electrical connection exists between the Exposed Thermal Pad (EP) and the  $V_{SS}$  pin. They must be connected to the same potential on the Printed Circuit Board (PCB).

# MCP73871

---

NOTES:

## 4.0 DEVICE OVERVIEW

The MCP73871 device is a simple but fully integrated linear charge management controller with system load sharing feature. Figure 4-1 depicts the operational flow algorithm.

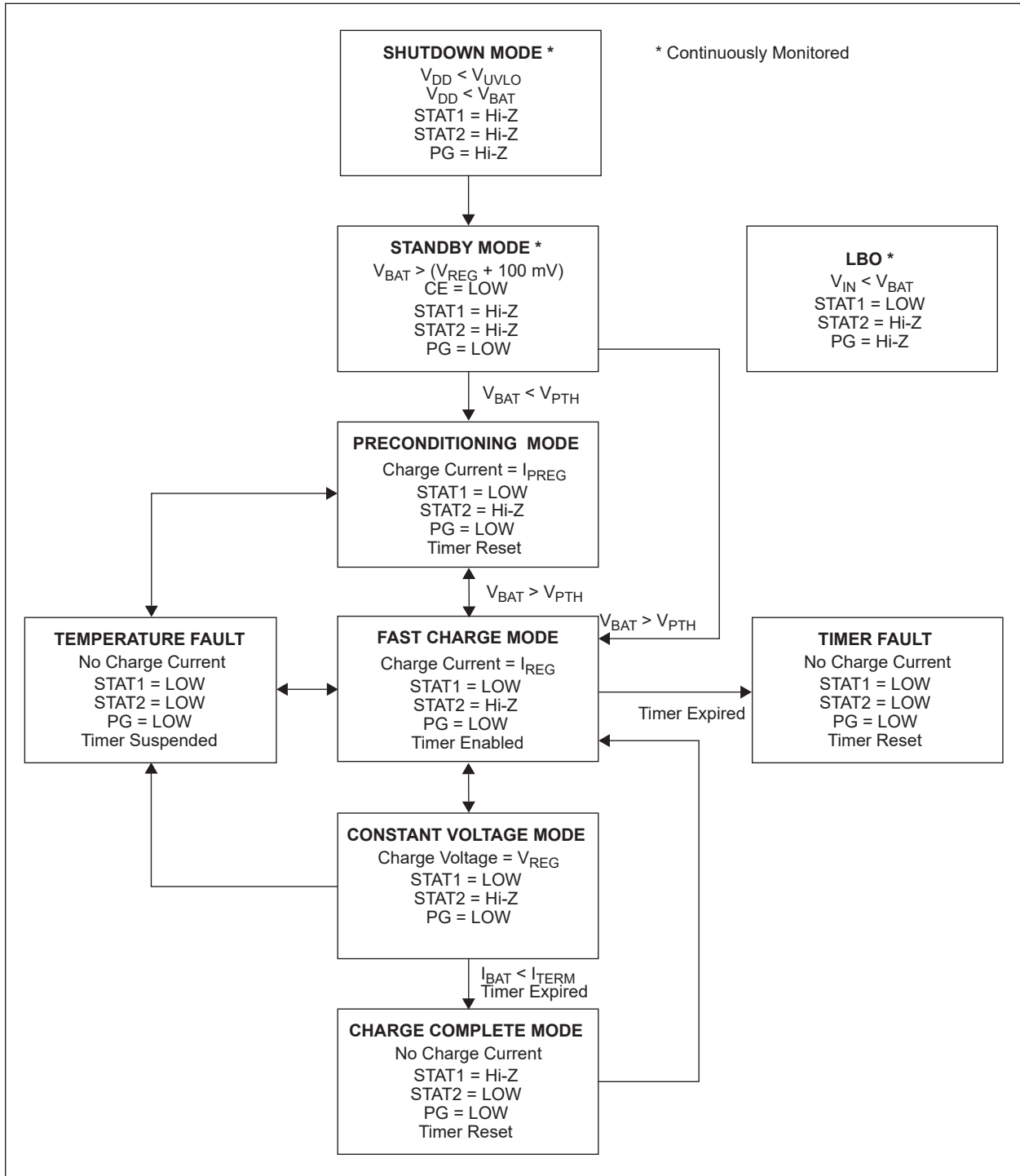


FIGURE 4-1: MCP73871 Device Flow Chart.

# MCP73871

Table 4-1 shows the chip behavior based upon the operating conditions.

**TABLE 4-1: CHIP BEHAVIOR REFERENCE TABLE**

	$V_{IN} ? V_{BAT}$	$V_{IN} > 2V$	$V_{IN} > UVLO$	CE	$V_{BAT} ? V_{OUT}$	State	Bias + VREF	Thermal Block	Synchronous Diode	I <sub>OUT</sub>	Charge
1	$V_{BAT} > V_{IN}$	0	0	0	—	Shutdown	OFF		OFF	OFF	
2				1		Battery powered system	ON				
3	$V_{IN} > V_{BAT}$	0	0	X	—	Shutdown	OFF				
4			0	0	—	Shutdown	ON	OFF		OFF	
5				1		Battery powered system		ON			
6	$V_{IN} > V_{BAT}$	1	1	0	$V_{BAT} < V_{OUT}$	Standby	ON	OFF		ON	OFF
7					$V_{BAT} > V_{OUT}$	IN + BAT powered system		ON			
8					$V_{BAT} < V_{OUT}$	IN powered, Charge possible		OFF			
9	$V_{BAT} > V_{OUT}$	IN + BAT powered system	ON		OFF						

## 4.1 UnderVoltage Lockout (UVLO)

An internal undervoltage lockout (UVLO) circuit monitors the input voltage and keeps the charger in shutdown mode until the input supply rises above the UVLO threshold.

In the event a battery is present when the input power is applied, the input supply must rise approximately 100 mV above the battery voltage before the MCP73871 device becomes operational.

The UVLO circuit places the device in Shutdown mode if the input supply falls to within approximately 100 mV of the battery voltage.

The UVLO circuit is always active. At any time the input supply is below the UVLO threshold or falls within approximately 100 mV of the voltage at the  $V_{BAT}$  pin, the MCP73871 device is placed in Shutdown mode.

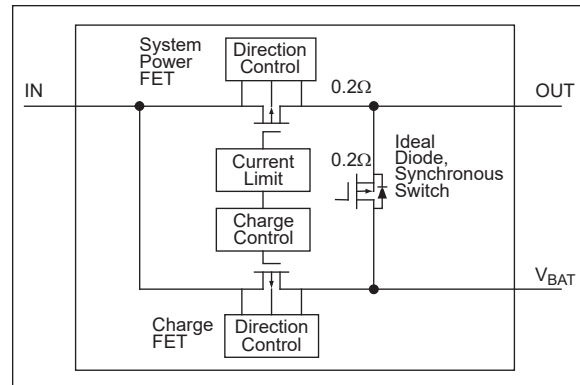
During any UVLO condition, the battery reverse discharge current is less than 2  $\mu$ A.

## 4.2 System Load Sharing

The system load sharing feature gives the system output pin (OUT) priority, allowing the system to power-up with deeply depleted battery packs.

With the SEL input active-low, the MCP73871 device is designed to provide system power and Li-Ion battery charging from a USB input while adhering to the current limits governed by the USB specification.

With the SEL input active-high, the MCP73871 device limits the total supply current to 1.8A (system power and charge current combined).



**FIGURE 4-2:** System Load Sharing Diagram.

## 4.3 Charge Qualification

For a charge cycle to begin, all UVLO conditions must be met and a battery or output load must be present.

A charge current programming resistor must be connected from PROG1 to  $V_{SS}$  when SEL = high. When SEL = low, PROG2 needs to be tied high or low for proper operation.

## 4.4 Preconditioning

If the voltage at the  $V_{BAT}$  pin is less than the preconditioning threshold, the MCP73871 device enters a preconditioning mode. The preconditioning threshold is factory set. Refer to [Section 1.0 “Electrical Characteristics”](#) for preconditioning threshold options.

In this mode, the MCP73871 device supplies 10% of the fast charge current (established with the value of the resistor connected to the PROG1 pin) to the battery.

When the voltage at the  $V_{BAT}$  pin rises above the preconditioning threshold, the MCP73871 device enters the Constant Current (fast charge) mode.

## 4.5 Constant Current Mode – Fast Charge

During the Constant Current mode, the programmed charge current is supplied to the battery or load. The charge current is established using a single resistor from PROG1 to  $V_{SS}$ . The program resistor and the charge current are calculated using the following equation:

**EQUATION 4-1:**

$I_{REG} = \frac{1000V}{R_{PROG1}}$
Where:
$R_{PROG}$ = kilo-ohms (k $\Omega$ )
$I_{REG}$ = milliamperes (mA)

Constant Current mode is maintained until the voltage at the  $V_{BAT}$  pin reaches the regulation voltage,  $V_{REG}$ .

When Constant Current mode is invoked, the internal timer is reset.

### 4.5.1 TIMER EXPIRED DURING CONSTANT CURRENT - FAST CHARGE MODE

If the internal timer expires before the recharge voltage threshold is reached, a timer fault is indicated and the charge cycle terminates. The MCP73871 device remains in this condition until the battery is removed. If the battery is removed, the MCP73871 device enters the Standby mode where it remains until a battery is reinserted.

## 4.6 Constant Voltage Mode

When the voltage at the  $V_{BAT}$  pin reaches the regulation voltage,  $V_{REG}$ , constant voltage regulation begins. The regulation voltage is factory set to 4.10V, 4.20V, 4.35V or 4.40V with a tolerance of  $\pm 0.5\%$ . The

first character of the operational output options code indicates the regulation voltage  $V_{REG}$ : 1 = 4.1V, 2 = 4.2V, 3 = 4.35V and 4 = 4.4V.

## 4.7 Charge Termination

The Constant Voltage mode charge cycle terminates either when the average charge current diminishes below a threshold established by the value of the resistor connected from PROG3 to  $V_{SS}$  or when the internal charge timer expires. When the charge cycle terminates due to a fully charged battery, the charge current is latched off and the MCP73871 device enters the Charge Complete mode. A 1 ms filter time on the termination comparator ensures that transient load conditions do not result in premature charge cycle termination. The timer period is factory set and can be disabled. Refer to [Section 1.0 “Electrical Characteristics”](#) for timer period options.

The program resistor and the charge current are calculated using the following equation:

**EQUATION 4-2:**

$I_{TERMINATION} = \frac{1000V}{R_{PROG3}}$
Where:
$R_{PROG}$ = kilo-ohms (k $\Omega$ )
$I_{REG}$ = milliamperes (mA)

The recommended PROG3 resistor values are between 5 k $\Omega$  and 100 k $\Omega$ .

## 4.8 Automatic Recharge

The MCP73871 device continuously monitors the voltage at the  $V_{BAT}$  pin in the Charge Complete mode. If the voltage drops below the recharge threshold, another charge cycle begins and current is supplied again to the battery or load. The recharge threshold is factory set. Refer to [Section 1.0 “Electrical Characteristics”](#) for recharge threshold options.

<b>Note:</b> Charge termination and automatic recharge features avoid constantly charging Li-Ion batteries, resulting in prolonged battery life while maintaining full cell capacity.
---

## 4.9 Thermal Regulation

The MCP73871 device limits the charge current based on the die temperature. The thermal regulation optimizes the charge cycle time while maintaining device reliability. Figure 4-3 depicts the thermal regulation for the MCP73871 device. Refer to Section 1.0 “Electrical Characteristics” for thermal package resistances and Section 6.1.1.2 “Thermal Considerations” for calculating power dissipation.

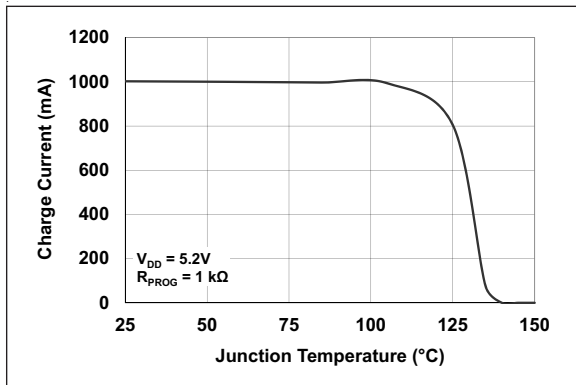


FIGURE 4-3: Thermal Regulation.

## 4.10 Thermal Shutdown

The MCP73871 device suspends charge if the die temperature exceeds 150°C. Charging resumes when the die temperature has cooled by approximately 10°C. The thermal shutdown is a secondary safety feature in the event that there is a failure within the thermal regulation circuitry.

## 4.11 Temperature Qualification

The MCP73871 device continuously monitors battery temperature during a charge cycle by measuring the voltage between the THERM and V<sub>SS</sub> pins. An internal 50 μA current source provides the bias for most common 10 kΩ NTC thermistors. The MCP73871 device compares the voltage at the THERM pin to factory set thresholds of 1.24V and 0.25V, typically. Once a voltage outside the thresholds is detected during a charge cycle, the MCP73871 device immediately suspends the charge cycle. The MCP73871 device suspends charging by turning off the charge pass transistor and holding the timer value. The charge cycle resumes when the voltage at the THERM pin returns to the normal range.

## 4.12 Voltage Proportional Charge Control (VPCC)

If the voltage on the IN pin drops to a preset value determined by the threshold established at the VPCC input due to a limited amount of input current or input source impedance, the battery charging current is reduced. The VPCC control tries to reach a steady state condition where the system load has priority and the battery is charged with the remaining current. Therefore, if the system demands more current than the input can provide, the ideal diode becomes forward-biased and the battery may supplement the input current to the system load.

The VPCC sustains the system load as its highest priority. It does this by reducing the noncritical charge current while maintaining the maximum power output of the adapter. Further demand from the system is supported by the battery, if possible.

The VPCC feature functions identically for USB port or AC-DC adapter inputs. This feature can be disabled by connecting the VPCC to IN pin.

## 4.13 Input Current Limit Control (ICLC)

If the input current threshold is reached, then the battery charging current is reduced. The ICLC tries to reach a steady state condition where the system load has priority and the battery is charged with the remaining current. No active control limits the current to the system. Therefore, if the system demands more current than the input can provide or the ICLC is reached, the ideal diode becomes forward biased and the battery may supplement the input current to the system load.

The ICLC sustains the system load as its highest priority. This is done by reducing the non-critical charge current while adhering to the current limits governed by the USB specification or the maximum AC-DC adapter current supported. Further demand from the system is supported by the battery, if possible.

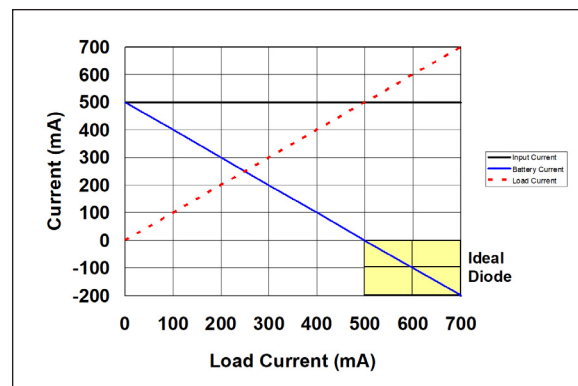


FIGURE 4-4: Input Current Limit Control - USB Port.



## 5.0 DETAILED DESCRIPTION

### 5.1 Analog Circuitry

#### 5.1.1 LOAD SHARING AND LI-ION BATTERY MANAGEMENT INPUT SUPPLY ( $V_{IN}$ )

The  $V_{IN}$  input is the input supply to the MCP73871 device. The MCP73871 device can be supplied by either AC Adapter ( $V_{AC}$ ) or USB Port ( $V_{USB}$ ) with SEL pin. The MCP73871 device automatically powers the system with the Li-Ion battery when the  $V_{IN}$  input is not present.

#### 5.1.2 FAST CHARGE CURRENT REGULATION SET (PROG1)

For the MCP73871 device, the charge current regulation can be scaled by placing a programming resistor ( $R_{PROG1}$ ) from the PROG1 pin to  $V_{SS}$ . The program resistor and the charge current are calculated using the following equation:

#### EQUATION 5-1:

$$I_{REG} = \frac{1000V}{R_{PROG1}}$$

Where:

$R_{PROG}$  = kilo-ohms (k $\Omega$ )

$I_{REG}$  = milliamperes (mA)

The fast charge current is set for maximum charge current from AC-DC adapter and USB port. The preconditioning current is 10% (0.1C) of the fast charge current.

#### 5.1.3 BATTERY CHARGE CONTROL OUTPUT ( $V_{BAT}$ )

The battery charge control output is the drain terminal of an internal P-channel MOSFET. The MCP73871 device provides constant current and voltage regulation to the battery pack by controlling this MOSFET in the linear region. The battery charge control output should be connected to the positive terminal of the battery pack.

#### 5.1.4 TEMPERATURE QUALIFICATION (THERM)

The MCP73871 device continuously monitors battery temperature during a charge cycle by measuring the voltage between the THERM and  $V_{SS}$  pins. An internal 50  $\mu$ A current source provides the bias for most common 10 k $\Omega$  NTC or Positive Temperature Coefficient (PTC) thermistors. The current source is controlled, avoiding measurement sensitivity to fluctuations in the supply voltage ( $V_{DD}$ ). The MCP73871 device compares the voltage at the THERM pin to factory set thresholds of 1.24V and 0.25V, typically. Once a voltage outside the thresholds is detected during a charge cycle, the MCP73871 device immediately suspends the charge cycle.

The MCP73871 device suspends the charge by turning off the pass transistor and holding the timer value. The charge cycle resumes when the voltage at the THERM pin returns to the normal range.

If temperature monitoring is not required, place a standard 10 k $\Omega$  resistor from THERM to  $V_{SS}$ .

### 5.2 Digital Circuitry

#### 5.2.1 STATUS INDICATORS AND POWER GOOD ( $\overline{PG}$ )

The charge status outputs have two different states: Low-Impedance (L) and High-Impedance (Hi-Z). The charge status outputs can be used to illuminate LEDs. Optionally, the charge status outputs can be used as an interface to a host microcontroller. [Table 5-1](#) summarizes the state of the status outputs during a charge cycle.

**TABLE 5-1: STATUS OUTPUTS**

CHARGE CYCLE STATE	STAT1	STAT2	$\overline{PG}$
Shutdown ( $V_{DD} = V_{BAT}$ )	Hi-Z	Hi-Z	Hi-Z
Shutdown ( $V_{DD} = IN$ )	Hi-Z	Hi-Z	L
Shutdown (CE = L)	Hi-Z	Hi-Z	L
Preconditioning	L	Hi-Z	L
Constant Current	L	Hi-Z	L
Constant Voltage	L	Hi-Z	L
Charge Complete - Standby	Hi-Z	L	L
Temperature Fault	L	L	L
Timer Fault	L	L	L
Low Battery Output	L	Hi-Z	Hi-Z
No Battery Present	Hi-Z	Hi-Z	L
No Input Power Present	Hi-Z	Hi-Z	Hi-Z

# MCP73871

---

## 5.2.2 AC-DC ADAPTER AND USB PORT POWER SOURCE REGULATION SELECT (SEL)

With the SEL input low, the MCP73871 device is designed to provide system power and Li-Ion battery charging from a USB input while adhering to the current limits governed by the USB specification. The host microcontroller has the option to select either a 100 mA (L) or a 500 mA (H) current limit based on the PROG2 input. With the SEL input high, the MCP73871 device limits the input current to 1.8A. The programmed charge current is established using a single resistor from PROG1 to  $V_{SS}$  when driving SEL high.

## 5.2.3 USB PORT CURRENT REGULATION SELECT (PROG2)

Driving the PROG2 input to a logic low selects the low USB port source current setting (maximum 100 mA). Driving the PROG2 input to a logic high selects the high USB port source current setting (maximum 500 mA).

## 5.2.4 POWER GOOD ( $\overline{PG}$ )

The power good ( $\overline{PG}$ ) option is a pseudo open-drain output. The  $\overline{PG}$  output can sink current, but not source current. The  $\overline{PG}$  output must not be pulled up higher than  $V_{IN}$  because there is a diode path back to  $V_{IN}$ . The  $\overline{PG}$  output is low whenever the input to the MCP73871 device is above the UVLO threshold and greater than the battery voltage. The  $\overline{PG}$  output can be used as an indication to the system that an input source other than the battery is supplying power.

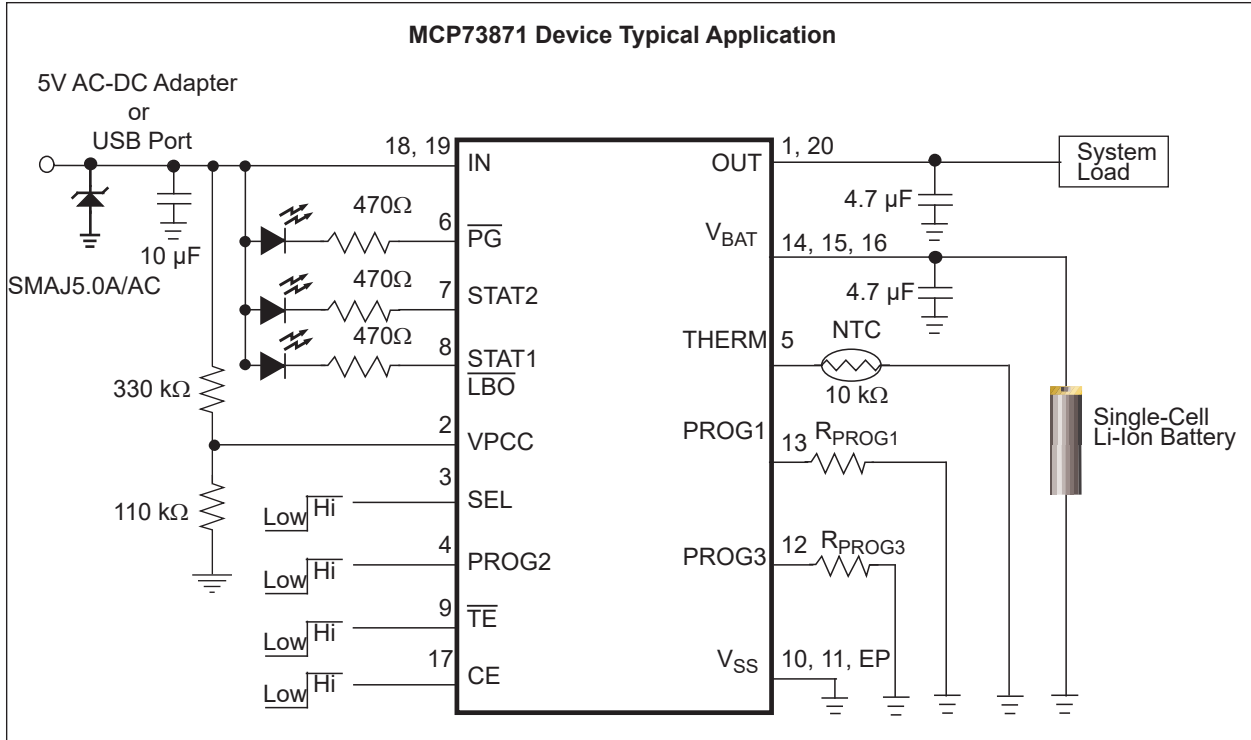
## 5.2.5 TIMER ENABLE ( $\overline{TE}$ ) OPTION

The timer enable ( $\overline{TE}$ ) input option is used to enable or disable the internal timer. A low signal on this pin enables the internal timer and a high signal disables the internal timer. The  $\overline{TE}$  input can be used to disable the timer when the charger is supplying current to charge the battery and power the system load. The  $\overline{TE}$  input is compatible with 1.8V logic.

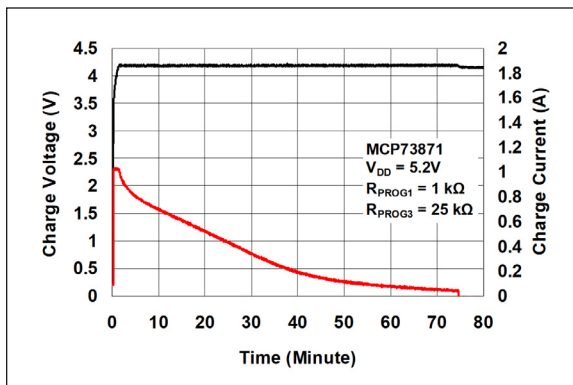
## 6.0 APPLICATIONS

The MCP73871 device is designed to operate in conjunction with a host microcontroller or in stand-alone applications. The MCP73871 device provides the preferred charge algorithm for Lithium-Ion

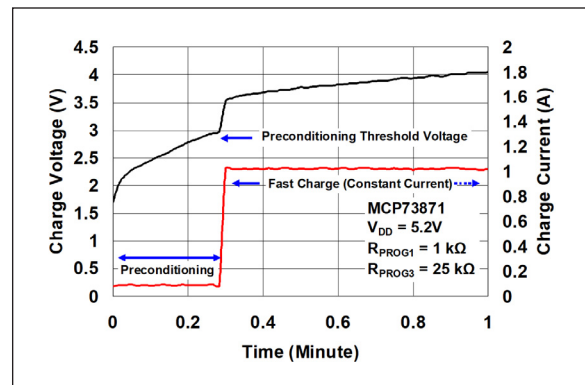
and Lithium-Polymer cells. The algorithm uses Constant Current mode followed by Constant Voltage mode. [Figure 6-1](#) depicts a typical stand-alone MCP73871 application circuit, while [Figure 6-2](#) and [Figure 6-3](#) depict the accompanying charge profile.



**FIGURE 6-1:** MCP73871 Typical Stand-Alone Application Circuit with VPCC.



**FIGURE 6-2:** Typical Charge Profile (1000 mAh Battery).



**FIGURE 6-3:** Typical Charge Profile in Preconditioning (1000 mAh Battery).

## 6.1 Application Circuit Design

Due to the low efficiency of linear charging, the most important factors are thermal design and cost, which are a direct function of the input voltage, output current and thermal impedance between the battery charger and the ambient cooling air. The worst-case situation is when the device has transitioned from the Preconditioning mode to the Constant Current mode. In this situation, the battery charger has to dissipate the maximum power. A trade-off must be made between the charge current, cost and thermal requirements of the charger.

### 6.1.1 COMPONENT SELECTION

Selection of the external components in [Figure 6-1](#) is crucial to the integrity and reliability of the charging system. The following discussion is intended as a guide for the component selection process.

#### 6.1.1.1 Charge Current

The preferred fast charge current for Lithium-Ion cells should always follow references and guidances from battery manufacturers. For example, a 1000 mAh battery pack has a preferred fast charge current of 0.7C. Charging at 700 mA provides the shortest charge cycle times without degradation to the battery pack performance or life.

#### 6.1.1.2 Thermal Considerations

The worst-case power dissipation in the battery charger occurs when the input voltage is at the maximum and the device has transitioned from the Preconditioning mode to the Constant Current mode. In this case, the power dissipation is:

#### EQUATION 6-1:

$$\text{PowerDissipation} = (V_{DDMAX} - V_{PTHMIN}) \times I_{REGMAX}$$

Where:

- $V_{DDMAX}$  = the maximum input voltage
- $I_{REGMAX}$  = the maximum fast charge current
- $V_{PTHMIN}$  = the minimum transition threshold voltage

For example, if  $V_{REG} = 4.2V$  and  $V_{PTH}/V_{REG} = 69\%$ , power dissipation with a 5V,  $\pm 10\%$  input voltage source and 500 mA,  $\pm 10\%$  fast charge current is:

#### EQUATION 6-2:

$$\text{PowerDissipation} = (5.5V - 2.89V) \times 550mA = 1.44W$$

This power dissipation with the battery charger in the QFN-20 package causes thermal regulation to enter as depicted. Alternatively, the 4 mm x 4 mm DFN package could be utilized to reduce heat by adding vias on the exposed pad.

#### 6.1.1.3 External Capacitors

The MCP73871 device is stable with or without a battery load. To maintain good AC stability in the Constant Voltage mode, a minimum capacitance of 4.7  $\mu F$  is recommended to bypass the  $V_{BAT}$  pin to  $V_{SS}$ . This capacitance provides compensation when there is no battery load. In addition, the battery and interconnections appear inductive at high frequencies. These elements are in the control feedback loop during Constant Voltage mode. Therefore, the bypass capacitance may be necessary to compensate for the inductive nature of the battery pack.

Virtually any good quality output filter capacitor can be used, regardless of the capacitor's minimum Effective Series Resistance (ESR) value. The actual value of the capacitor (and its associated ESR) depends on the output load current. A 4.7  $\mu F$  ceramic, tantalum or aluminum electrolytic capacitor at the output is usually sufficient to ensure stability for charge currents up to 1000 mA.

#### 6.1.1.4 Reverse-Blocking Protection

The MCP73871 device provides protection from a faulted or shorted input. Without the protection, a faulted or shorted input would discharge the battery pack through the body diode of the internal pass transistor.

#### 6.1.1.5 Temperature Monitoring

The charge temperature window can be set by placing fixed value resistors in series-parallel with a thermistor. The resistance values of  $R_{T1}$  and  $R_{T2}$  can be calculated with the following equations to set the temperature window of interest.

For NTC thermistors:

#### EQUATION 6-3:

$$24k\Omega = R_{T1} + \frac{R_{T2} \times R_{COLD}}{R_{T2} + R_{COLD}}$$

$$5k\Omega = R_{T1} + \frac{R_{T2} \times R_{HOT}}{R_{T2} + R_{HOT}}$$

Where:

- $R_{T1}$  = the fixed series resistance
- $R_{T2}$  = the fixed parallel resistance
- $R_{COLD}$  = the thermistor resistance at the lower temperature of interest
- $R_{HOT}$  = the thermistor resistance at the upper temperature of interest

For example, by utilizing a 10 k $\Omega$  at 25°C NTC thermistor with a sensitivity index,  $\beta$ , of 3892, the charge temperature range can be set to 0-50°C by placing a 1.54 k $\Omega$  resistor in series ( $R_{T1}$ ), and a 69.8 k $\Omega$  resistor in parallel ( $R_{T2}$ ) with the thermistor.

#### 6.1.1.6 Charge Status Interface

A status output provides information on the state of charge. The output can be used to illuminate external LEDs or interface to a host microcontroller. Refer to [Table 5-1](#) for a summary of the state of the status output during a charge cycle.

#### 6.1.1.7 System Load Current

The preferred discharge current for Lithium-Ion cells should always follow references and guidance from battery manufacturers. The recommended system load should be the lesser of 1.0 amperes or the maximum discharge rate of the selected Lithium-Ion cell. This limits the safety concerns of power dissipation and exceeding the manufacturer's maximum discharge rate of the cell.

The ideal diode between  $V_{BAT}$  and OUT is designed to drive a maximum current up to 2A. The built-in thermal shutdown protection may turn the MCP73871 device off with high current.

#### 6.1.1.8 Input Overvoltage Protection (IOVP)

The input overvoltage protection must be used when the input power source is hot-pluggable. This includes USB cables and wall-type power supplies. The cabling of these supplies acts as an inductor. When the supplies are connected/disconnected from the system, large voltage transients are created and this may damage the system circuitry. These transients should be snubbed out. A unidirectional or bidirectional transzorb connected from the V+ input supply connector to the 0V ground reference will snub the transients. An example can be seen in [Figure 6-1](#).

## 6.2 PCB Layout Issues

For optimum voltage regulation, it is recommended to place the battery pack closest to the device's  $V_{BAT}$  and  $V_{SS}$  pins to minimize voltage drops along the high current-carrying PCB traces.

If the PCB layout is used as a heat sink, adding many vias in the heat sink pad can help conduct more heat to the PCB backplane, thus reducing the maximum junction temperature.

# MCP73871

---

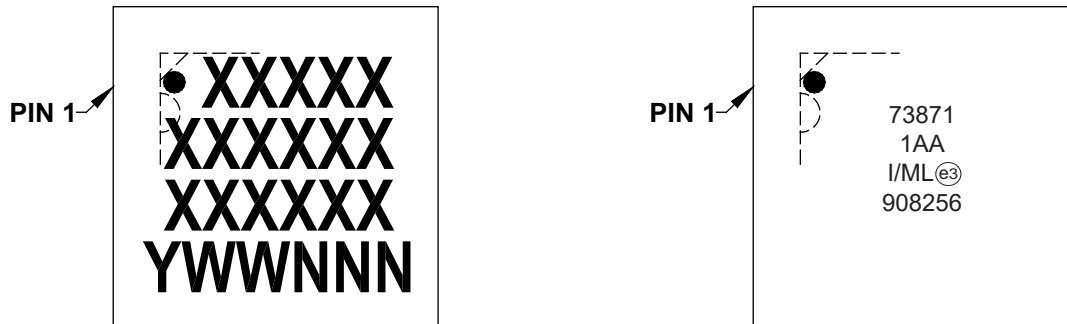
NOTES:

## 7.0 PACKAGING INFORMATION

### 7.1 Package Marking Information

20-Lead QFN (4 x 4 x 0.9 mm)

Example



Part Number *	Marking Code (Second Row)	Part Number *	Marking Code (Second Row)
MCP73871-1AAI/ML	1AA	MCP73871T-1AAI/ML	1AA
MCP73871-1CAI/ML	1CA	MCP73871T-1CAI/ML	1CA
MCP73871-1CCI/ML	1CC	MCP73871T-1CCI/ML	1CC
MCP73871-2AAI/ML	2AA	MCP73871T-2AAI/ML	2AA
MCP73871-2CAI/ML	2CA	MCP73871T-2CAI/ML	2CA
MCP73871-2CCI/ML	2CC	MCP73871T-2CCI/ML	2CC
MCP73871-3CAI/ML	3CA	MCP73871T-3CAI/ML	3CA
MCP73871-3CCI/ML	3CC	MCP73871T-3CCI/ML	3CC
MCP73871-4CAI/ML	4CA	MCP73871T-4CAI/ML	4CA
MCP73871-4CCI/ML	4CC	MCP73871T-4CCI/ML	4CC

\* Consult Factory for Alternative Device Options.

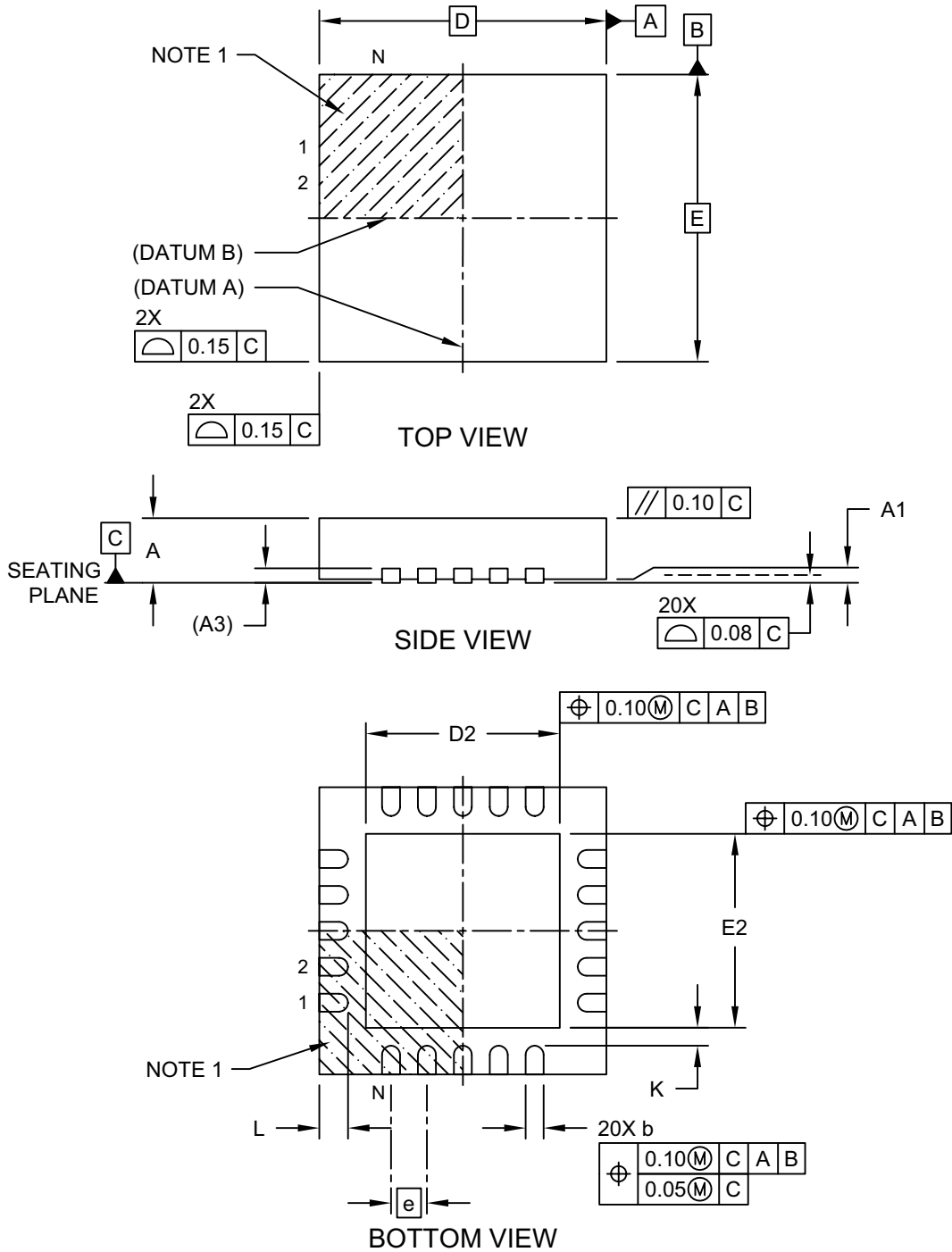
**Legend:** XX...X Customer-specific information  
 Y Year code (last digit of calendar year)  
 YY Year code (last 2 digits of calendar year)  
 WW Week code (week of January 1 is week '01')  
 NNN Alphanumeric traceability code  
 (e3) Pb-free JEDEC designator for Matte Tin (Sn)  
 \* This package is Pb-free. The Pb-free JEDEC designator (e3) can be found on the outer packaging for this package.

**Note:** In the event the full Microchip part number cannot be marked on one line, it will be carried over to the next line, thus limiting the number of available characters for customer-specific information.

# MCP73871

## 20-Lead Plastic Quad Flat, No Lead Package (ML) - 4x4 mm Body [QFN] Also called VQFN

**Note:** For the most current package drawings, please see the Microchip Packaging Specification located at <http://www.microchip.com/packaging>

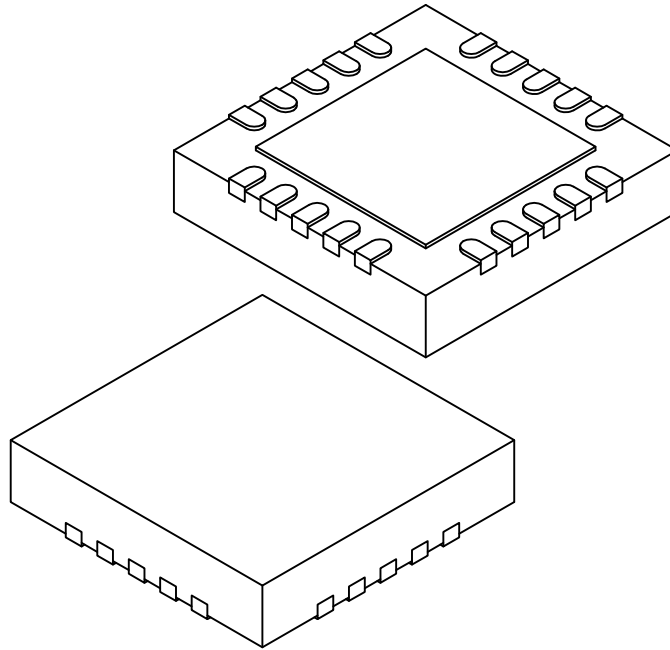


Microchip Technology Drawing C04-126 Rev C Sheet 1 of 2



## 20-Lead Plastic Quad Flat, No Lead Package (ML) - 4x4 mm Body [QFN] Also called VQFN

**Note:** For the most current package drawings, please see the Microchip Packaging Specification located at <http://www.microchip.com/packaging>



Dimension Limits	Units	MILLIMETERS		
		MIN	NOM	MAX
Number of Terminals	N	20		
Pitch	e	0.50 BSC		
Overall Height	A	0.80	0.90	1.00
Standoff	A1	0.00	0.02	0.05
Terminal Thickness	A3	0.20 REF		
Overall Length	D	4.00 BSC		
Exposed Pad Length	D2	2.60	2.70	2.80
Overall Width	E	4.00 BSC		
Exposed Pad Width	E2	2.60	2.70	2.80
Terminal Width	b	0.18	0.25	0.30
Terminal Length	L	0.30	0.40	0.50
Terminal-to-Exposed-Pad	K	0.20	-	-

**Notes:**

1. Pin 1 visual index feature may vary, but must be located within the hatched area.
2. Package is saw singulated
3. Dimensioning and tolerancing per ASME Y14.5M

BSC: Basic Dimension. Theoretically exact value shown without tolerances.

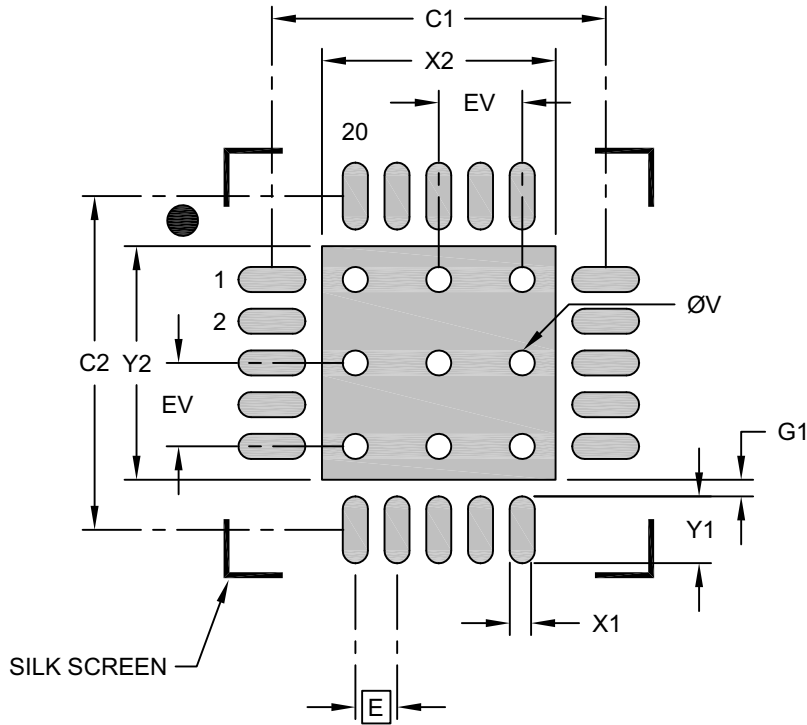
REF: Reference Dimension, usually without tolerance, for information purposes only.

Microchip Technology Drawing C04-126 Rev C Sheet 2 of 2

# MCP73871

## 20-Lead Plastic Quad Flat, No Lead Package (ML) - 4x4 mm Body [QFN] Also called VQFN

**Note:** For the most current package drawings, please see the Microchip Packaging Specification located at <http://www.microchip.com/packaging>



### RECOMMENDED LAND PATTERN

Dimension Limits	Units	MILLIMETERS		
		MIN	NOM	MAX
Contact Pitch	E	0.50 BSC		
Optional Center Pad Width	X2			2.80
Optional Center Pad Length	Y2			2.80
Contact Pad Spacing	C1		4.00	
Contact Pad Spacing	C2		4.00	
Contact Pad Width (X20)	X1			0.30
Contact Pad Length (X20)	Y1			0.80
Contact Pad to Center Pad (X16)	G1	0.20		
Thermal Via Diameter	V		0.30	
Thermal Via Pitch	EV		1.00	

**Notes:**

- Dimensioning and tolerancing per ASME Y14.5M  
BSC: Basic Dimension. Theoretically exact value shown without tolerances.
- For best soldering results, thermal vias, if used, should be filled or tented to avoid solder loss during reflow process

Microchip Technology Drawing C04-2126 Rev B

## APPENDIX A: REVISION HISTORY

### Revision E (April 2019)

The following is the list of modifications:

1. Updated the DC Characteristics table.
2. Updated Figure 2-14, Figure 2-15, Figure 2-16, and Figure 4-3.
3. Updated **Section 3.14 “Timer Enable (TE)”**.
4. Updated **Section 6.1.1.2 “Thermal Considerations”** and Equation 6-2.

### Revision D (February 2018)

The following is the list of modifications:

1. Corrected Figure 2-26.
2. Added Figure 2-27.
3. Updated Figure 6-1.
4. Added **Section 6.1.1.8 “Input Overvoltage Protection (IOVP)”**.
5. Minor typographical edits.

### Revision C (September 2013)

The following is the list of modifications:

1. Updated Functional Block Diagram.
2. Added Table 4-1 in **Section 4.0 “Device Overview”**.
3. Updated **Section 7.0 “Packaging Information”**.
4. Minor grammatical and editorial corrections.

### Revision B (May 2009)

The following is the list of modifications:

1. Updated the QFN-20 package drawing.
2. Updated Equation 4-1.
3. Updated **Section 4.7 “Charge Termination”** and Equation 4-2.
4. Updated Equation 5-1.

### Revision A (July 2008)

- Original Release of this Document.

# MCP73871

---

NOTES:

## PRODUCT IDENTIFICATION SYSTEM

To order or obtain information, e.g., on pricing or delivery, refer to the factory or the listed sales office.

PART NO.	XX	X/	XX	
Device	Output Options*	Temp.	Package	
<p><b>Device:</b> MCP73871: USB/AC Battery Charger with PPM MCP73871T: USB/AC Battery Charger with PPM (Tape and Reel)</p> <p><b>Output Options **</b> * Refer to table below for different operational options. ** Consult Factory for Alternative Device Options.</p> <p><b>Temperature:</b> I = -40°C to +85°C</p> <p><b>Package Type:</b> ML = Plastic Quad Flat No Lead (QFN) (4x4x0.9 mm Body), 20-lead</p>				
				<p><b>Examples: **</b></p> <p>a) MCP73871-1AAI/ML: 4.10V PPM Battery Charger, 20LD QFN pkg.</p> <p>b) MCP73871-1CAI/ML: 4.10V, PPM Battery Charger, 20LD QFN pkg.</p> <p>c) MCP73871-1CCI/ML: 4.10V, PPM Battery Charger, 20LD QFN pkg.</p> <p>d) MCP73871-2AAI/ML: 4.20V, PPM Battery Charger, 20LD QFN pkg.</p> <p>e) MCP73871-2CAI/ML: 4.20V PPM Battery Charger, 20LD QFN pkg.</p> <p>f) MCP73871-2CCI/ML: 4.20V PPM Battery Charger, 20LD QFN pkg.</p> <p>g) MCP73871-3CAI/ML: 4.35V PPM Battery Charger, 20LD QFN pkg.</p> <p>h) MCP73871-3CCI/ML: 4.35V PPM Battery Charger, 20LD QFN pkg.</p> <p>** Consult Factory for Alternative Device Options</p>

### \* Operational Output Options

Output Options	V <sub>REG</sub>	Safety Timer Duration (Hours)	LBO Voltage Threshold (V)
1AA	4.10V	Disabled	Disabled
1CA	4.10V	6	Disabled
1CC	4.10V	6	3.1
2AA	4.20V	Disabled	Disabled
2CA	4.20V	6	Disabled
2CC	4.20V	6	3.1
3CA	4.35V	6	Disabled
3CC	4.35V	6	3.1
4CA	4.40V	6	Disabled
4CC	4.40V	6	3.1

\*\* Consult Factory for Alternative Device Options.

# MCP73871

---

NOTES:

---

---

**Note the following details of the code protection feature on Microchip devices:**

- Microchip products meet the specification contained in their particular Microchip Data Sheet.
- Microchip believes that its family of products is one of the most secure families of its kind on the market today, when used in the intended manner and under normal conditions.
- There are dishonest and possibly illegal methods used to breach the code protection feature. All of these methods, to our knowledge, require using the Microchip products in a manner outside the operating specifications contained in Microchip's Data Sheets. Most likely, the person doing so is engaged in theft of intellectual property.
- Microchip is willing to work with the customer who is concerned about the integrity of their code.
- Neither Microchip nor any other semiconductor manufacturer can guarantee the security of their code. Code protection does not mean that we are guaranteeing the product as “unbreakable.”

Code protection is constantly evolving. We at Microchip are committed to continuously improving the code protection features of our products. Attempts to break Microchip's code protection feature may be a violation of the Digital Millennium Copyright Act. If such acts allow unauthorized access to your software or other copyrighted work, you may have a right to sue for relief under that Act.

---

Information contained in this publication regarding device applications and the like is provided only for your convenience and may be superseded by updates. It is your responsibility to ensure that your application meets with your specifications. MICROCHIP MAKES NO REPRESENTATIONS OR WARRANTIES OF ANY KIND WHETHER EXPRESS OR IMPLIED, WRITTEN OR ORAL, STATUTORY OR OTHERWISE, RELATED TO THE INFORMATION, INCLUDING BUT NOT LIMITED TO ITS CONDITION, QUALITY, PERFORMANCE, MERCHANTABILITY OR FITNESS FOR PURPOSE. Microchip disclaims all liability arising from this information and its use. Use of Microchip devices in life support and/or safety applications is entirely at the buyer's risk, and the buyer agrees to defend, indemnify and hold harmless Microchip from any and all damages, claims, suits, or expenses resulting from such use. No licenses are conveyed, implicitly or otherwise, under any Microchip intellectual property rights unless otherwise stated.

*Microchip received ISO/TS-16949:2009 certification for its worldwide headquarters, design and wafer fabrication facilities in Chandler and Tempe, Arizona; Gresham, Oregon and design centers in California and India. The Company's quality system processes and procedures are for its PIC® MCUs and dsPIC® DSCs, KEELoq® code hopping devices, Serial EEPROMs, microperipherals, nonvolatile memory and analog products. In addition, Microchip's quality system for the design and manufacture of development systems is ISO 9001:2000 certified.*

**QUALITY MANAGEMENT SYSTEM  
CERTIFIED BY DNV  
= ISO/TS 16949 =**

### Trademarks

The Microchip name and logo, the Microchip logo, AnyRate, AVR, AVR logo, AVR Freaks, BitCloud, chipKIT, chipKIT logo, CryptoMemory, CryptoRF, dsPIC, FlashFlex, flexPWR, Helder, JukeBlox, KeeLoq, Klear, LANCheck, LINK MD, maXStylus, maXTouch, MediaLB, megaAVR, MOST, MOST logo, MPLAB, OptoLyzer, PIC, picoPower, PICSTART, PIC32 logo, Prochip Designer, QTouch, SAM-BA, SpyNIC, SST, SST Logo, SuperFlash, tinyAVR, UNI/O, and XMEGA are registered trademarks of Microchip Technology Incorporated in the U.S.A. and other countries.

ClockWorks, The Embedded Control Solutions Company, EtherSynch, Hyper Speed Control, HyperLight Load, IntellIMOS, mTouch, Precision Edge, and Quiet-Wire are registered trademarks of Microchip Technology Incorporated in the U.S.A.

Adjacent Key Suppression, AKS, Analog-for-the-Digital Age, Any Capacitor, AnyIn, AnyOut, BodyCom, CodeGuard, CryptoAuthentication, CryptoAutomotive, CryptoCompanion, CryptoController, dsPICDEM, dsPICDEM.net, Dynamic Average Matching, DAM, ECAN, EtherGREEN, In-Circuit Serial Programming, ICSP, INICnet, Inter-Chip Connectivity, JitterBlocker, KlearNet, KlearNet logo, memBrain, Mindi, MiWi, motorBench, MPASM, MPF, MPLAB Certified logo, MPLIB, MPLINK, MultiTRAK, NetDetach, Omniscient Code Generation, PICDEM, PICDEM.net, PICKit, PICtail, PowerSmart, PureSilicon, QMatrix, REAL ICE, Ripple Blocker, SAM-ICE, Serial Quad I/O, SMART-I.S., SQI, SuperSwitcher, SuperSwitcher II, Total Endurance, TSHARC, USBCheck, VariSense, ViewSpan, WiperLock, Wireless DNA, and ZENA are trademarks of Microchip Technology Incorporated in the U.S.A. and other countries.

SQTP is a service mark of Microchip Technology Incorporated in the U.S.A.

Silicon Storage Technology is a registered trademark of Microchip Technology Inc. in other countries.

GestIC is a registered trademark of Microchip Technology Germany II GmbH & Co. KG, a subsidiary of Microchip Technology Inc., in other countries.

All other trademarks mentioned herein are property of their respective companies.

© 2008-2019, Microchip Technology Incorporated, All Rights Reserved.

ISBN: 978-1-5224-4441-1



# MICROCHIP

## Worldwide Sales and Service

### AMERICAS

**Corporate Office**  
2355 West Chandler Blvd.  
Chandler, AZ 85224-6199  
Tel: 480-792-7200  
Fax: 480-792-7277  
Technical Support:  
<http://www.microchip.com/support>  
Web Address:  
[www.microchip.com](http://www.microchip.com)

#### Atlanta

Duluth, GA  
Tel: 678-957-9614  
Fax: 678-957-1455

#### Austin, TX

Tel: 512-257-3370

#### Boston

Westborough, MA  
Tel: 774-760-0087  
Fax: 774-760-0088

#### Chicago

Itasca, IL  
Tel: 630-285-0071  
Fax: 630-285-0075

#### Dallas

Addison, TX  
Tel: 972-818-7423  
Fax: 972-818-2924

#### Detroit

Novi, MI  
Tel: 248-848-4000

#### Houston, TX

Tel: 281-894-5983

#### Indianapolis

Noblesville, IN  
Tel: 317-773-8323  
Fax: 317-773-5453  
Tel: 317-536-2380

#### Los Angeles

Mission Viejo, CA  
Tel: 949-462-9523  
Fax: 949-462-9608  
Tel: 951-273-7800

#### Raleigh, NC

Tel: 919-844-7510

#### New York, NY

Tel: 631-435-6000

#### San Jose, CA

Tel: 408-735-9110  
Tel: 408-436-4270

#### Canada - Toronto

Tel: 905-695-1980  
Fax: 905-695-2078

### ASIA/PACIFIC

**Australia - Sydney**  
Tel: 61-2-9868-6733

**China - Beijing**  
Tel: 86-10-8569-7000

**China - Chengdu**  
Tel: 86-28-8665-5511

**China - Chongqing**  
Tel: 86-23-8980-9588

**China - Dongguan**  
Tel: 86-769-8702-9880

**China - Guangzhou**  
Tel: 86-20-8755-8029

**China - Hangzhou**  
Tel: 86-571-8792-8115

**China - Hong Kong SAR**  
Tel: 852-2943-5100

**China - Nanjing**  
Tel: 86-25-8473-2460

**China - Qingdao**  
Tel: 86-532-8502-7355

**China - Shanghai**  
Tel: 86-21-3326-8000

**China - Shenyang**  
Tel: 86-24-2334-2829

**China - Shenzhen**  
Tel: 86-755-8864-2200

**China - Suzhou**  
Tel: 86-186-6233-1526

**China - Wuhan**  
Tel: 86-27-5980-5300

**China - Xian**  
Tel: 86-29-8833-7252

**China - Xiamen**  
Tel: 86-592-2388138

**China - Zhuhai**  
Tel: 86-756-3210040

### ASIA/PACIFIC

**India - Bangalore**  
Tel: 91-80-3090-4444

**India - New Delhi**  
Tel: 91-11-4160-8631

**India - Pune**  
Tel: 91-20-4121-0141

**Japan - Osaka**  
Tel: 81-6-6152-7160

**Japan - Tokyo**  
Tel: 81-3-6880-3770

**Korea - Daegu**  
Tel: 82-53-744-4301

**Korea - Seoul**  
Tel: 82-2-554-7200

**Malaysia - Kuala Lumpur**  
Tel: 60-3-7651-7906

**Malaysia - Penang**  
Tel: 60-4-227-8870

**Philippines - Manila**  
Tel: 63-2-634-9065

**Singapore**  
Tel: 65-6334-8870

**Taiwan - Hsin Chu**  
Tel: 886-3-577-8366

**Taiwan - Kaohsiung**  
Tel: 886-7-213-7830

**Taiwan - Taipei**  
Tel: 886-2-2508-8600

**Thailand - Bangkok**  
Tel: 66-2-694-1351

**Vietnam - Ho Chi Minh**  
Tel: 84-28-5448-2100

### EUROPE

**Austria - Wels**  
Tel: 43-7242-2244-39  
Fax: 43-7242-2244-393

**Denmark - Copenhagen**  
Tel: 45-4450-2828  
Fax: 45-4485-2829

**Finland - Espoo**  
Tel: 358-9-4520-820

**France - Paris**  
Tel: 33-1-69-53-63-20  
Fax: 33-1-69-30-90-79

**Germany - Garching**  
Tel: 49-8931-9700

**Germany - Haan**  
Tel: 49-2129-3766400

**Germany - Heilbronn**  
Tel: 49-7131-67-3636

**Germany - Karlsruhe**  
Tel: 49-721-625370

**Germany - Munich**  
Tel: 49-89-627-144-0  
Fax: 49-89-627-144-44

**Germany - Rosenheim**  
Tel: 49-8031-354-560

**Israel - Ra'anana**  
Tel: 972-9-744-7705

**Italy - Milan**  
Tel: 39-0331-742611  
Fax: 39-0331-466781

**Italy - Padova**  
Tel: 39-049-7625286

**Netherlands - Drunen**  
Tel: 31-416-690399  
Fax: 31-416-690340

**Norway - Trondheim**  
Tel: 47-7288-4388

**Poland - Warsaw**  
Tel: 48-22-3325737

**Romania - Bucharest**  
Tel: 40-21-407-87-50

**Spain - Madrid**  
Tel: 34-91-708-08-90  
Fax: 34-91-708-08-91

**Sweden - Gothenberg**  
Tel: 46-31-704-60-40

**Sweden - Stockholm**  
Tel: 46-8-5090-4654

**UK - Wokingham**  
Tel: 44-118-921-5800  
Fax: 44-118-921-5820



## X-ON Electronics

Largest Supplier of Electrical and Electronic Components

*Click to view similar products for [Battery Management](#) category:*

*Click to view products by [Microchip](#) manufacturer:*

Other Similar products are found below :

[MP26121DQ-LF-P](#) [NCP1855FCCT1G](#) [FAN54063UCX](#) [LC05132C01NMTTTG](#) [SN2040DSQR](#) [ME4075AM5G](#) [AP5054HTCER](#) [XPD977B](#)  
[XPD977B18](#) [4056H](#) [DW01](#) [DW06](#) [CM1002-UD](#) [CM1002-W](#) [CM1002-X](#) [CM1002-Y](#) [CM1006-B](#) [CM1006-Q](#) [CM1006-WB](#) [CM1006-LCD](#)  
[CM1006-LBD](#) [CM1006-WF](#) [CM1006-LF](#) [CM1006-WG](#) [CM1006-WH](#) [CM1006-LG](#) [CM1003-S02BD](#) [CM1003-S09EA](#) [CM1003-S10ED](#)  
[CM1003-S11ED](#) [CM1003-S12BC](#) [CM1003-S13CC](#) [CM1003-S24BC](#) [CM1003-S26BC](#) [CM1003-WAD](#) [CM1003-BBD](#) [CM1003-BFD](#)  
[CM1003-BND](#) [CM1003-BLD](#) [CM1003-DAD](#) [CM1003-BMD](#) [CM1003-BPD](#) [CM1003-BKD](#) [CM1003-BAE](#) [CM1003-BHE](#) [CM1102B-FF](#)  
[CM1102B-FD](#) [CM1102B-GD](#) [CM1112-DAE](#) [CM1112-DBE](#)