

Low-Power Linear Active Thermistor ICs

Features

- Tiny Analog Temperature Sensor
- Available Packages:
 - SC70-5, SOT-23-3, TO-92-3
- Wide Temperature Measurement Range:
 - -40°C to +125°C (Extended Temperature)
 - -40°C to +150°C (High Temperature)
 - (MCP9700, SOT-23-3 and SC70-5 only)**
- Accuracy:
 - $\pm 2^{\circ}\text{C}$ (max.), 0°C to +70°C (**MCP9700A/9701A**)
 - $\pm 4^{\circ}\text{C}$ (max.), 0°C to +70°C (**MCP9700/9701**)
- Optimized for Analog-to-Digital Converters (ADCs):
 - 10.0 mV/°C (typical) (**MCP9700/9700A**)
 - 19.5 mV/°C (typical) (**MCP9701/9701A**)
- Wide Operating Voltage Range:
 - $V_{DD} = 2.3\text{V}$ to 5.5V (**MCP9700/9700A**)
 - $V_{DD} = 3.1\text{V}$ to 5.5V (**MCP9701/9701A**)
- Low Operating Current: 6 μA (typical)
- Optimized to Drive Large Capacitive Loads

Typical Applications

- Hard Disk Drives and Other PC Peripherals
- Entertainment Systems
- Home Appliance
- Office Equipment
- Battery Packs and Portable Equipment
- General Purpose Temperature Monitoring

General Description

MCP9700/9700A and MCP9701/9701A sensors with Linear Active Thermistor Integrated Circuit (IC) comprise a family of analog temperature sensors that convert temperature to analog voltage.

The low-cost, low-power sensors feature an accuracy of $\pm 2^{\circ}\text{C}$ from 0°C to +70°C (MCP9700A/9701A) and $\pm 4^{\circ}\text{C}$ from 0°C to +70°C (MCP9700/9701) while consuming 6 μA (typical) of operating current.

Unlike resistive sensors, e.g., thermistors, the Linear Active Thermistor IC does not require an additional signal-conditioning circuit. Therefore, the biasing circuit development overhead for thermistor solutions can be avoided by implementing a sensor from these low-cost devices. The Voltage Output pin (V_{OUT}) can be directly connected to the ADC input of a microcontroller. The MCP9700/9700A and MCP9701/9701A temperature coefficients are scaled to provide a 1°C/bit resolution for an 8-bit ADC with a reference voltage of 2.5V and 5V, respectively. The MCP9700/9700A output 0.1°C/bit for a 12-bit ADC with 4.096V reference.

The MCP9700/9700A and MCP9701/9701A provide a low-cost solution for applications that require measurement of a relative change of temperature. When measuring relative change in temperature from +25°C, an accuracy of $\pm 1^{\circ}\text{C}$ (typical) can be realized from 0°C to +70°C. This accuracy can also be achieved by applying system calibration at +25°C.

In addition, this family of devices is immune to the effects of parasitic capacitance and can drive large capacitive loads. This provides printed circuit board (PCB) layout design flexibility by enabling the device to be remotely located from the microcontroller. Adding some capacitance at the output also helps the output transient response by reducing overshoots or undershoots. However, capacitive load is not required for the stability of sensor output.

Package Types

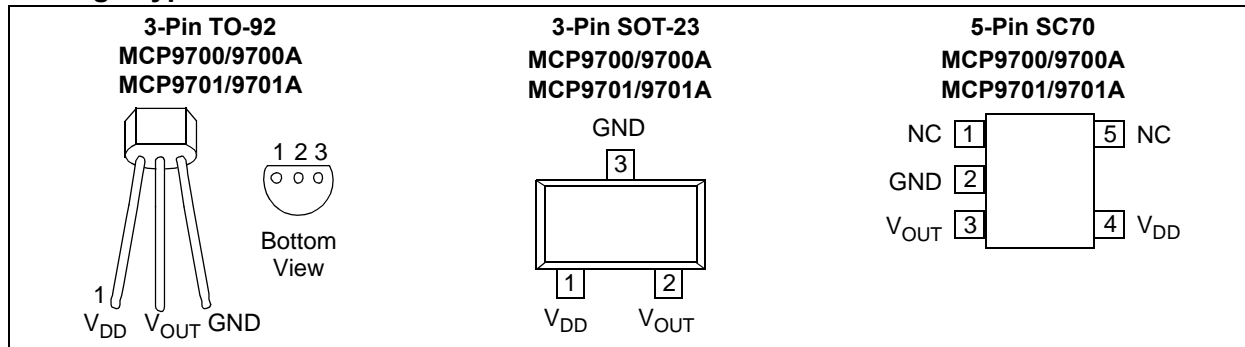

MCP9700/9700A and MCP9701/9701A

1.0 ELECTRICAL CHARACTERISTICS

Absolute Maximum Ratings †

V _{DD}	6.0V
Storage Temperature.....	-65°C to +150°C
Ambient Temp. with Power Applied...	-40°C to +150°C
Output Current	±30 mA
Junction Temperature (T _J).....	150°C
ESD Protection on All Pins (HBM:MM)	(4 kV:200V)
Latch-Up Current at Each Pin	±200 mA

† **Notice:** Stresses above those listed under “Maximum Ratings” may cause permanent damage to the device. This is a stress rating only and functional operation of the device at those or any other conditions above those indicated in the operational listings of this specification is not implied. Exposure to maximum rating conditions for extended periods may affect device reliability.

DC ELECTRICAL CHARACTERISTICS

Electrical Specifications: Unless otherwise indicated:						
MCP9700/9700A: V _{DD} = 2.3V to 5.5V, GND = Ground, T _A = -40°C to +125°C and No load						
MCP9701/9701A: V _{DD} = 3.1V to 5.5V, GND = Ground, T _A = -10°C to +125°C and No load						
Parameter	Sym.	Min.	Typ.	Max.	Unit	Conditions
Power Supply						
Operating Voltage Range	V _{DD}	2.3	—	5.5	V	MCP9700/9700A
	V _{DD}	3.1	—	5.5	V	MCP9701/9701A
Operating Current	I _{DD}	—	6	12	μA	
	I _{DD}	—	—	15	μA	T _A = 150°C (Note 1)
Line Regulation	Δ°C/ΔV _{DD}	—	0.1	—	°C/V	
Sensor Accuracy (Notes 2, 3)						
T _A = +25°C	T _{ACY}	—	±1	—	°C	
T _A = 0°C to +70°C	T _{ACY}	-2.0	±1	+2.0	°C	MCP9700A/9701A
T _A = -40°C to +125°C	T _{ACY}	-2.0	±1	+4.0	°C	MCP9700A
T _A = -10°C to +125°C	T _{ACY}	-2.0	±1	+4.0	°C	MCP9701A
T _A = 0°C to +70°C	T _{ACY}	-4.0	±2	+4.0	°C	MCP9700/9701
T _A = -40°C to +125°C	T _{ACY}	-4.0	±2	+6.0	°C	MCP9700
T _A = -10°C to +125°C	T _{ACY}	-4.0	±2	+6.0	°C	MCP9701
T _A = -40°C to +150°C	T _{ACY}	-4.0	±2	+6.0	°C	High Temperature (Note 1)
Sensor Output						
Output Voltage, T _A = 0°C	V _{0°C}	—	500	—	mV	MCP9700/9700A
Output Voltage, T _A = 0°C	V _{0°C}	—	400	—	mV	MCP9701/9701A
Temperature Coefficient	T _C	—	10.0	—	mV/°C	MCP9700/9700A
	T _C	—	19.5	—	mV/°C	MCP9701/9701A
Output Nonlinearity	V _{ONL}	—	±0.5	—	°C	T _A = 0°C to +70°C (Note 3)

Note 1: MCP9700 with SC70-5 and SOT-23-3 packages only. The MCP9700 High Temperature is not available with TO-92 package.

2: The MCP9700/9700A family accuracy is tested with V_{DD} = 3.3V, while the MCP9701/9701A accuracy is tested with V_{DD} = 5.0V.

3: The MCP9700/9700A and MCP9701/9701A family is characterized using the first-order or linear equation, as shown in Equation 4-2. Also refer to Figure 2-16.

4: The MCP9700/9700A and MCP9701/9701A family is characterized and production tested with a capacitive load of 1000 pF.

5: SC70-5 package thermal response with 1x1 inch, dual-sided copper clad, TO-92-3 package thermal response without PCB (leaded).

MCP9700/9700A and MCP9701/9701A

DC ELECTRICAL CHARACTERISTICS (CONTINUED)

Electrical Specifications: Unless otherwise indicated:						
MCP9700/9700A: $V_{DD} = 2.3V$ to $5.5V$, GND = Ground, $T_A = -40^{\circ}C$ to $+125^{\circ}C$ and No load						
MCP9701/9701A: $V_{DD} = 3.1V$ to $5.5V$, GND = Ground, $T_A = -10^{\circ}C$ to $+125^{\circ}C$ and No load						
Parameter	Sym.	Min.	Typ.	Max.	Unit	Conditions
Output Current	I_{OUT}	—	—	100	μA	
Output Impedance	Z_{OUT}	—	20	—	Ω	$I_{OUT} = 100 \mu A$, $f = 500$ Hz
Output Load Regulation	$\frac{\Delta V_{OUT}}{\Delta I_{OUT}}$	—	1	—	Ω	$T_A = 0^{\circ}C$ to $+70^{\circ}C$ $I_{OUT} = 100 \mu A$
Turn-On Time	t_{ON}	—	800	—	μs	
Typical Load Capacitance	C_{LOAD}	—	—	1000	pF	Note 4
SC-70 Thermal Response to 63%	t_{RES}	—	1.3	—	s	30°C (Air) to $+125^{\circ}C$ (Fluid Bath) (Note 5)
TO-92 Thermal Response to 63%	t_{RES}	—	1.65	—	s	

- Note 1:** MCP9700 with SC70-5 and SOT-23-3 packages only. The MCP9700 High Temperature is not available with TO-92 package.
- 2:** The MCP9700/9700A family accuracy is tested with $V_{DD} = 3.3V$, while the MCP9701/9701A accuracy is tested with $V_{DD} = 5.0V$.
- 3:** The MCP9700/9700A and MCP9701/9701A family is characterized using the first-order or linear equation, as shown in [Equation 4-2](#). Also refer to [Figure 2-16](#).
- 4:** The MCP9700/9700A and MCP9701/9701A family is characterized and production tested with a capacitive load of 1000 pF.
- 5:** SC70-5 package thermal response with 1x1 inch, dual-sided copper clad, TO-92-3 package thermal response without PCB (lead).

TEMPERATURE CHARACTERISTICS

Electrical Specifications: Unless otherwise indicated:						
MCP9700/9700A: $V_{DD} = 2.3V$ to $5.5V$, GND = Ground, $T_A = -40^{\circ}C$ to $+125^{\circ}C$ and No load						
MCP9701/9701A: $V_{DD} = 3.1V$ to $5.5V$, GND = Ground, $T_A = -10^{\circ}C$ to $+125^{\circ}C$ and No load						
Parameters	Sym.	Min.	Typ.	Max.	Units	Conditions
Temperature Ranges						
Specified Temperature Range (Note 1)	T_A	-40	—	+125	$^{\circ}C$	MCP9700/9700A
	T_A	-10	—	+125	$^{\circ}C$	MCP9701/9701A
	T_A	-40	—	+150	$^{\circ}C$	High Temperature (MCP9700 , SOT23-3 and SC70-5 only)
Operating Temperature Range	T_A	-40	—	+125	$^{\circ}C$	Extended Temperature
	T_A	-40	—	+150	$^{\circ}C$	High Temperature
Storage Temperature Range	T_A	-65	—	+150	$^{\circ}C$	
Thermal Package Resistances						
Thermal Resistance, 5LD SC70	θ_{JA}	—	331	—	$^{\circ}C/W$	
Thermal Resistance, 3LD SOT-23	θ_{JA}	—	308	—	$^{\circ}C/W$	
Thermal Resistance, 3LD TO-92	θ_{JA}	—	146	—	$^{\circ}C/W$	

- Note 1:** Operation in this range must not cause T_J to exceed Maximum Junction Temperature ($+150^{\circ}C$).

MCP9700/9700A and MCP9701/9701A

2.0 TYPICAL PERFORMANCE CURVES

Note: The graphs and tables provided following this note are a statistical summary based on a limited number of samples and are provided for informational purposes only. The performance characteristics listed herein are not tested or guaranteed. In some graphs or tables, the data presented may be outside the specified operating range (e.g., outside specified power supply range) and therefore outside the warranted range.

Note: Unless otherwise indicated, **MCP9700/9700A:** $V_{DD} = 2.3V$ to $5.5V$; **MCP9701/9701A:** $V_{DD} = 3.1V$ to $5.5V$; GND = Ground, $C_{bypass} = 0.1 \mu F$.

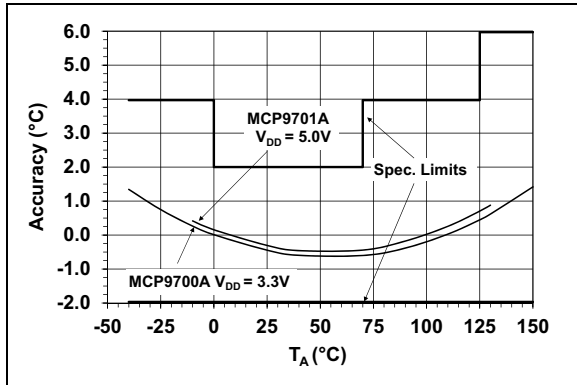

FIGURE 2-1: Accuracy vs. Ambient Temperature (MCP9700A/9701A).

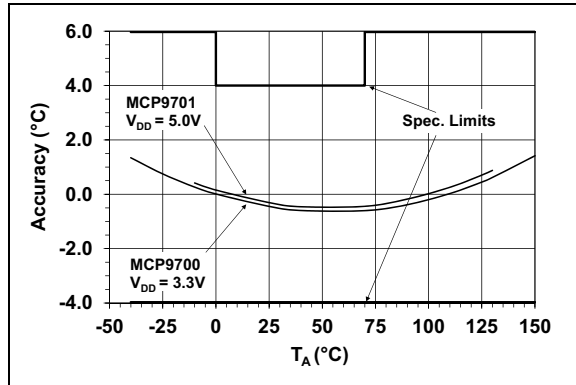

FIGURE 2-4: Accuracy vs. Ambient Temperature (MCP9700/9701).

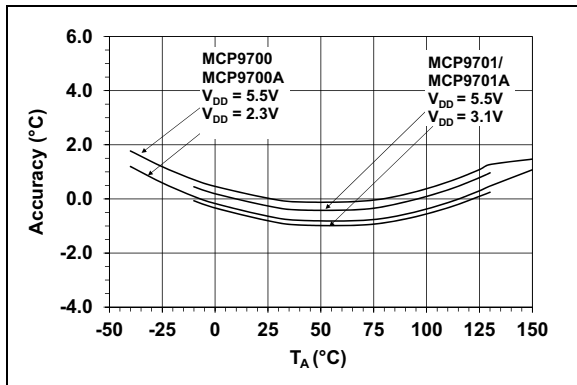

FIGURE 2-2: Accuracy vs. Ambient Temperature, with V_{DD} .

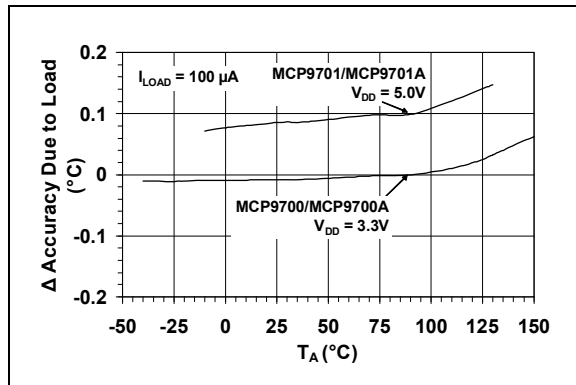

FIGURE 2-5: Changes in Accuracy vs. Ambient Temperature (Due to Load).

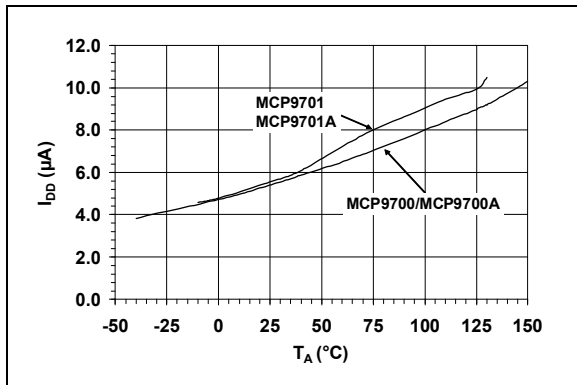

FIGURE 2-3: Supply Current vs. Temperature.

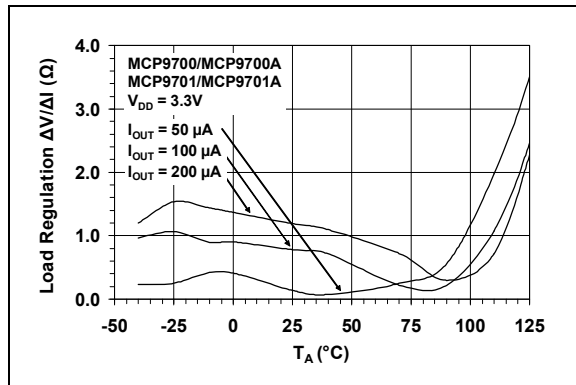

FIGURE 2-6: Load Regulation vs. Ambient Temperature.

MCP9700/9700A and MCP9701/9701A

Note: Unless otherwise indicated, **MCP9700/9700A:** $V_{DD} = 2.3V$ to $5.5V$; **MCP9701/9701A:** $V_{DD} = 3.1V$ to $5.5V$; GND = Ground, $C_{bypass} = 0.1 \mu F$.

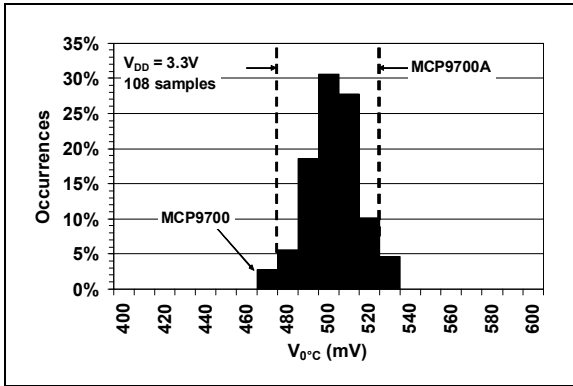

FIGURE 2-7: Output Voltage at $0^{\circ}C$ (MCP9700/9700A).

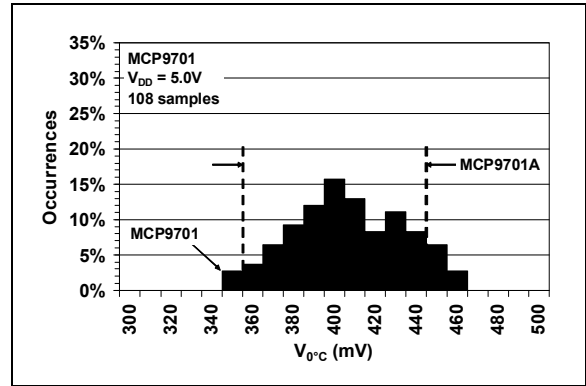

FIGURE 2-10: Output Voltage at $0^{\circ}C$ (MCP9701/9701A).

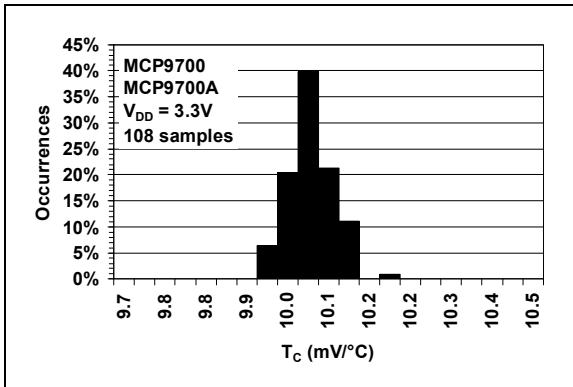

FIGURE 2-8: Occurrences vs. Temperature Coefficient (MCP9700/9700A).

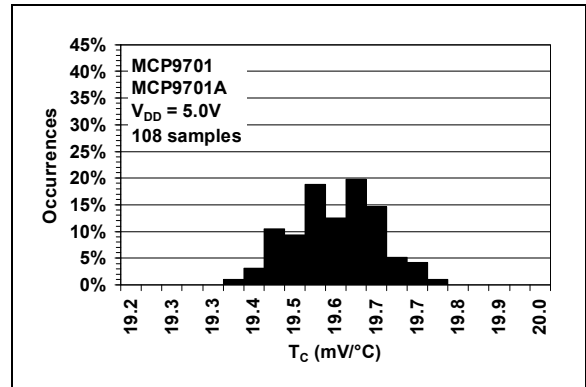

FIGURE 2-11: Occurrences vs. Temperature Coefficient (MCP9701/9701A).

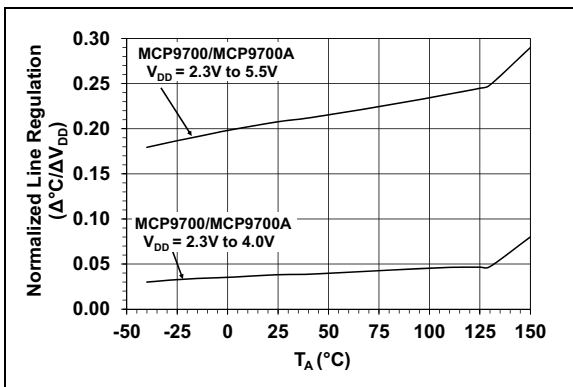

FIGURE 2-9: Line Regulation ($\Delta^{\circ}C/\Delta V_{DD}$) vs. Ambient Temperature.

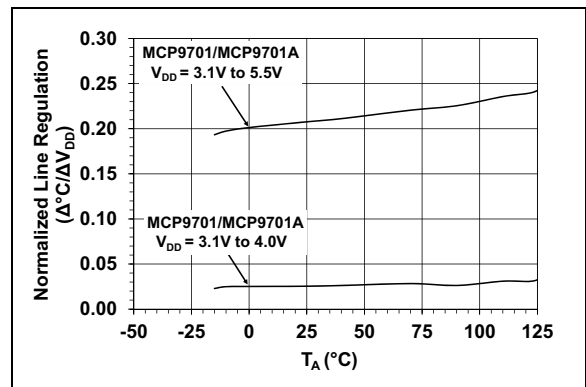

FIGURE 2-12: Line Regulation ($\Delta^{\circ}C/\Delta V_{DD}$) vs. Ambient Temperature.

MCP9700/9700A and MCP9701/9701A

Note: Unless otherwise indicated, MCP9700/9700A: $V_{DD} = 2.3V$ to $5.5V$; MCP9701/9701A: $V_{DD} = 3.1V$ to $5.5V$; GND = Ground, $C_{bypass} = 0.1 \mu F$.

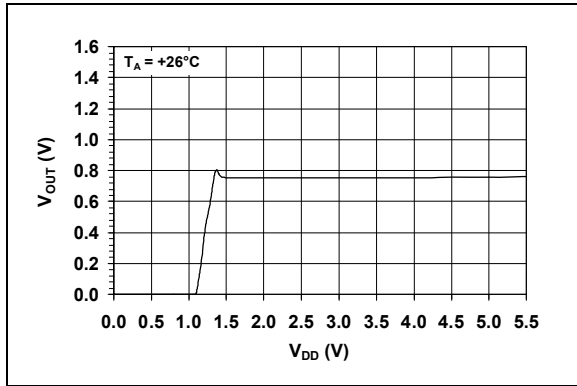

FIGURE 2-13: Output Voltage vs. Power Supply.

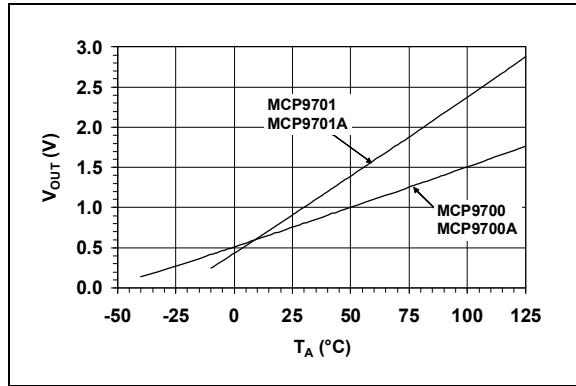

FIGURE 2-16: Output Voltage vs. Ambient Temperature.

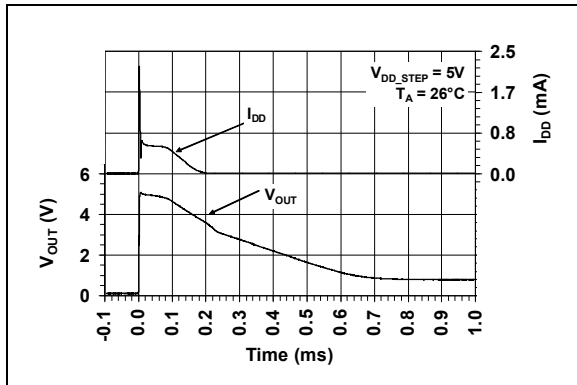

FIGURE 2-14: Output vs. Settling Time to Step V_{DD} .

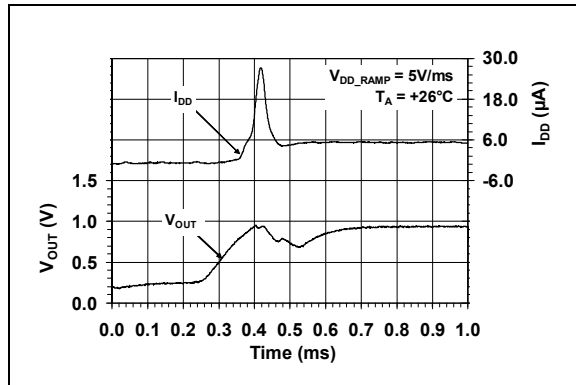

FIGURE 2-17: Output vs. Settling Time to Ramp V_{DD} .

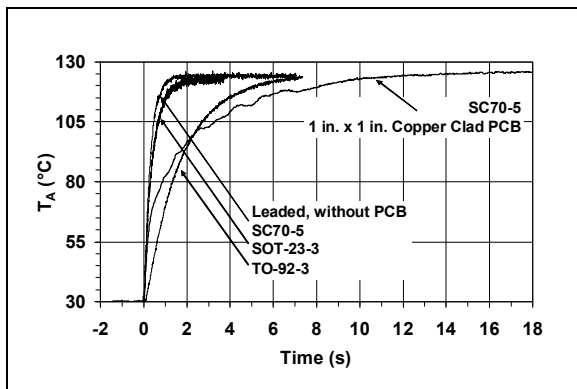

FIGURE 2-15: Thermal Response (Air-to-Fluid Bath).

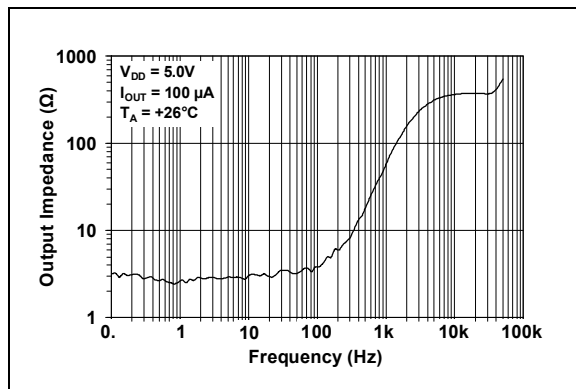

FIGURE 2-18: Output Impedance vs. Frequency.

MCP9700/9700A and MCP9701/9701A

3.0 PIN DESCRIPTIONS

The descriptions of the pins are listed in [Table 3-1](#).

TABLE 3-1: PIN FUNCTION TABLE

Pin No. SC70	Pin No. SOT-23	Pin No. TO-92	Symbol	Function
1	—	—	NC	No Connect (this pin is not connected to the die.)
2	3	3	GND	Power Ground Pin
3	2	2	V _{OUT}	Output Voltage Pin
4	1	1	V _{DD}	Power Supply Input
5	—	—	NC	No Connect (this pin is not connected to the die.)

3.1 Power Ground Pin (GND)

GND is the system ground pin.

3.2 Output Voltage Pin (V_{OUT})

The sensor output can be measured at V_{OUT}. The voltage range over the operating temperature range for the MCP9700/9700A is 100 mV to 1.75V. The voltage range over the operating temperature range for the MCP9701/9701A is 200 mV to 3V.

3.3 Power Supply Input (V_{DD})

The operating voltage as specified in the [DC Electrical Characteristics](#) table is applied to V_{DD}.

3.4 No Connect Pin (NC)

This pin is not connected to the die. It can be used to improve thermal conduction to the package by connecting it to a printed circuit board (PCB) trace from the thermal source.

MCP9700/9700A and MCP9701/9701A

4.0 APPLICATIONS INFORMATION

The Linear Active Thermistor™ IC uses an internal diode to measure temperature. The diode electrical characteristics have a temperature coefficient that provides a change in voltage based on the relative ambient temperature from -40°C to 150°C. The change in voltage is scaled to a temperature coefficient of 10.0 mV/°C (typical) for the MCP9700/9700A and 19.5 mV/°C (typical) for the MCP9701/9701A. The output voltage at 0°C is also scaled to 500 mV (typical) and 400 mV (typical) for the MCP9700/9700A and MCP9701/9701A, respectively. This linear scale is described in the first-order transfer function shown in Equation 4-1 and Figure 2-16.

EQUATION 4-1: SENSOR TRANSFER FUNCTION

$$V_{OUT} = T_C \times T_A + V_{0^\circ C}$$

Where:

- T_A = Ambient Temperature
- V_{OUT} = Sensor Output Voltage
- $V_{0^\circ C}$ = Sensor Output Voltage at 0°C (see [DC Electrical Characteristics](#) table)
- T_C = Temperature Coefficient (see [DC Electrical Characteristics](#) table)

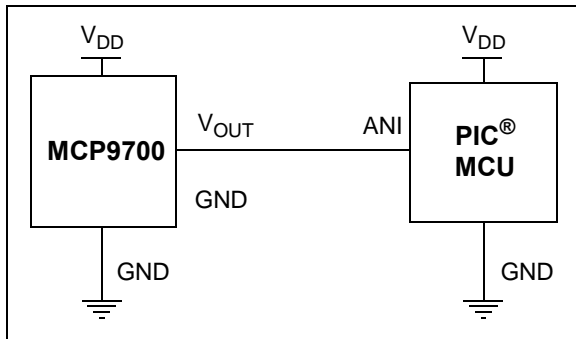

FIGURE 4-1: Typical Application Circuit.

4.1 Improving Accuracy

The MCP9700/9700A and MCP9701/9701A accuracy can be improved by performing a system calibration at a specific temperature. For example, calibrating the system at +25°C ambient improves the measurement accuracy to a ±0.5°C (typical) from 0°C to +70°C, as shown in Figure 4-2. Therefore, when measuring relative temperature change, this family of devices measures temperature with higher accuracy.

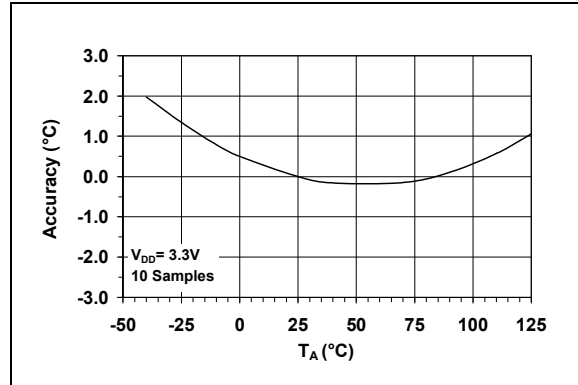

FIGURE 4-2: Relative Accuracy to +25°C vs. Temperature.

The change in accuracy from the calibration temperature is due to the output nonlinearity from the first-order equation, as specified in Equation 4-2. The accuracy can be further improved by compensating for the output nonlinearity.

For higher accuracy using a sensor compensation technique, refer to Application Note AN1001, "IC Temperature Sensor Accuracy Compensation with a PIC® Microcontroller" (DS00001001). The application note shows that if the device is compensated in addition to room temperature calibration, the sensor accuracy can be improved to ±0.5°C (typical) accuracy over the operating temperature (Figure 4-3).

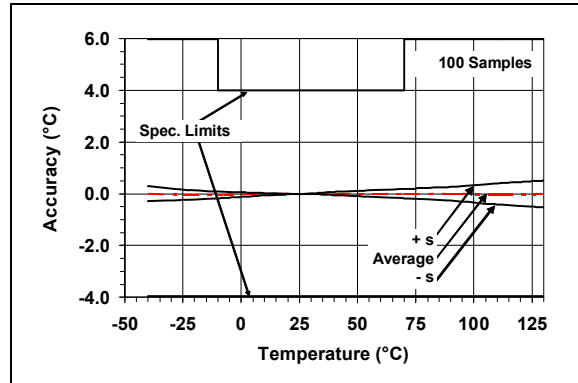

FIGURE 4-3: MCP9700/9700A Calibrated Sensor Accuracy.

The compensation technique provides a linear temperature reading. The application note includes compensation firmware so that a look-up table can be generated to compensate for the sensor error.

MCP9700/9700A and MCP9701/9701A

4.2 Shutdown Using Microcontroller I/O Pin

The 6 μA (typical) low operating current of the MCP9700/9700A and MCP9701/9701A family makes it ideal for battery-powered applications. However, for applications that require a tighter current budget, this device can be powered using a microcontroller Input/Output (I/O) pin. The I/O pin can be toggled to shut down the device. In such applications, the microcontroller internal digital switching noise is emitted to the MCP9700/9700A and MCP9701/9701A as power supply noise. However, this switching noise compromises measurement accuracy, therefore a decoupling capacitor and series resistor will be necessary to filter out the system noise.

4.3 Layout Considerations

The MCP9700/9700A and MCP9701/9701A family of sensors does not require any additional components to operate. However, it is recommended that a decoupling capacitor of 0.1 μF to 1 μF be used between the V_{DD} and GND pins. In high-noise applications, connect the power supply voltage to the V_{DD} pin using a 200 Ω resistor with a 1 μF decoupling capacitor. A high frequency ceramic capacitor is recommended. It is necessary that the capacitor is located as close as possible to the V_{DD} and GND pins in order to provide effective noise protection. In addition, avoid tracing digital lines in close proximity to the sensor.

4.4 Thermal Considerations

The MCP9700/9700A and MCP9701/9701A family measures temperature by monitoring the voltage of a diode located in the die. A low-impedance thermal path between the die and the PCB is provided by the pins. Therefore, the sensor effectively monitors the temperature of the PCB. However, the thermal path for the ambient air is not as efficient because the plastic device package functions as a thermal insulator from the die. This limitation applies to plastic-packaged silicon temperature sensors. If the application requires the measurement of ambient air, the TO-92 package should be considered.

The MCP9700/9700A and MCP9701/9701A sensors are designed to source/sink 100 μA (max.). The power dissipation due to the output current is relatively insignificant. The effect of the output current can be described by [Equation 4-2](#).

EQUATION 4-2: EFFECT OF SELF-HEATING

$$T_J - T_A = \theta_{JA}(V_{DD}I_{DD} + (V_{DD} - V_{OUT})I_{OUT})$$

Where:

T_J = Junction Temperature

T_A = Ambient Temperature

θ_{JA} = Package Thermal Resistance (331 $^{\circ}\text{C}/\text{W}$)

V_{OUT} = Sensor Output Voltage

I_{OUT} = Sensor Output Current

I_{DD} = Operating Current

V_{DD} = Operating Voltage

At $T_A = +25^{\circ}\text{C}$ ($V_{OUT} = 0.75\text{V}$) and maximum specification of $I_{DD} = 12\ \mu\text{A}$, $V_{DD} = 5.5\text{V}$ and $I_{OUT} = +100\ \mu\text{A}$, the self-heating due to power dissipation ($T_J - T_A$) is 0.179 $^{\circ}\text{C}$.

MCP9700/9700A and MCP9701/9701A

5.0 PACKAGING INFORMATION

5.1 Package Marking Information

5-Lead SC70

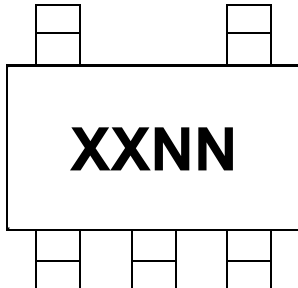

Device	Code
MCP9700T-E/LT	AUNN
MCP9700AT-E/LT	AXNN
MCP9700T-H/LT	BCNN
MCP9701T-E/LT	AVNN
MCP9701AT-E/LT	AYNN

Note: Applies to 5-Lead SC70.

Example

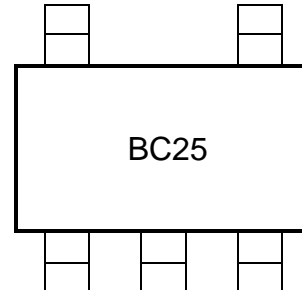

3-Lead SOT-23

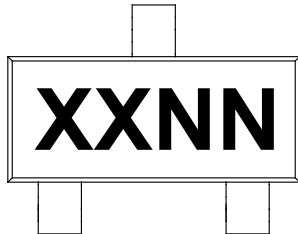

Device	Code
MCP9700T-E/TT	AENN
MCP9700AT-E/TT	AFNN
MCP9700T-H/TT	AGNN
MCP9701T-E/TT	AMNN
MCP9701AT-E/TT	APNN

Note: Applies to 3-Lead SOT-23.

Example

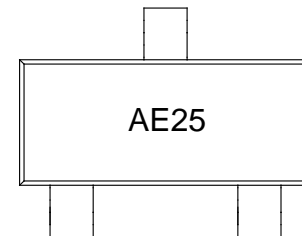

3-Lead TO-92

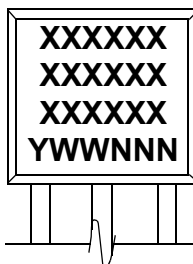

Device
MCP9700-E/TO
MCP9700A-E/TO
MCP9701-E/TO
MCP9701A-E/TO

Note: Applies to 3-Lead TO-92.

Example

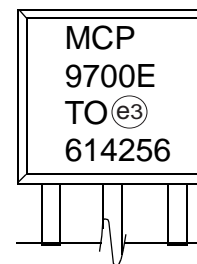

Legend:	XX...X	Customer-specific information
	Y	Year code (last digit of calendar year)
	YY	Year code (last 2 digits of calendar year)
	WW	Week code (week of January 1 is week '01')
	NNN	Alphanumeric traceability code
	(e3)	Pb-free JEDEC® designator for Matte Tin (Sn)
	*	This package is Pb-free. The Pb-free JEDEC designator (e3) can be found on the outer packaging for this package.

Note: In the event the full Microchip part number cannot be marked on one line, it will be carried over to the next line, thus limiting the number of available characters for customer-specific information.

MCP9700/9700A and MCP9701/9701A

5-Lead Plastic Small Outline Transistor (LT) [SC70]

Note: For the most current package drawings, please see the Microchip Packaging Specification located at <http://www.microchip.com/packaging>

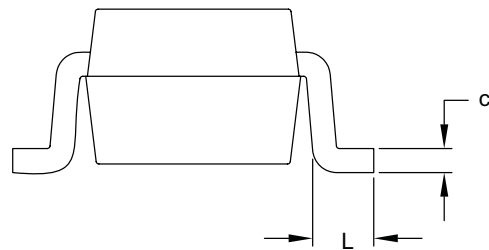
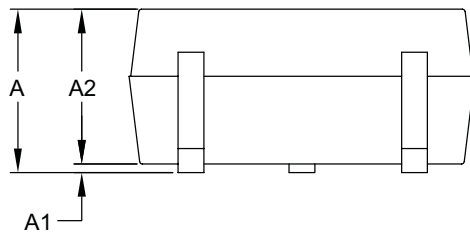
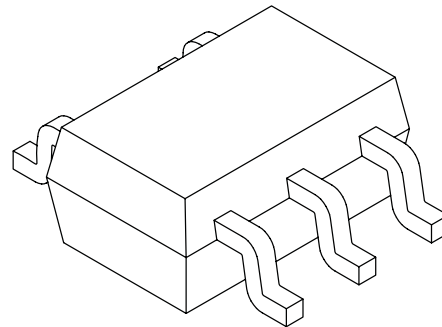
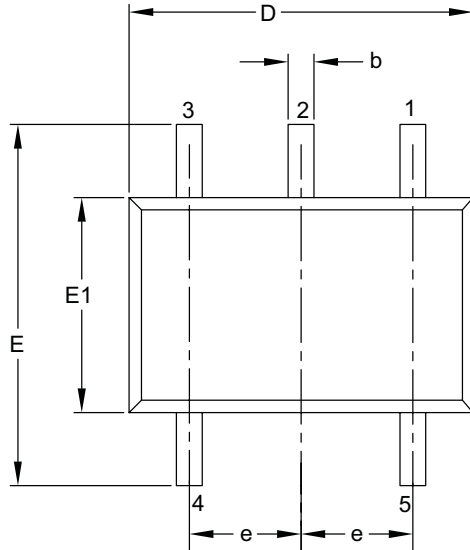

Dimension Limits	Units	MILLIMETERS		
		MIN	NOM	MAX
Number of Pins	N	5		
Pitch	e	0.65 BSC		
Overall Height	A	0.80	–	1.10
Molded Package Thickness	A2	0.80	–	1.00
Standoff	A1	0.00	–	0.10
Overall Width	E	1.80	2.10	2.40
Molded Package Width	E1	1.15	1.25	1.35
Overall Length	D	1.80	2.00	2.25
Foot Length	L	0.10	0.20	0.46
Lead Thickness	c	0.08	–	0.26
Lead Width	b	0.15	–	0.40

Notes:

- Dimensions D and E1 do not include mold flash or protrusions. Mold flash or protrusions shall not exceed 0.127 mm per side.
- Dimensioning and tolerancing per ASME Y14.5M.
BSC: Basic Dimension. Theoretically exact value shown without tolerances.

Microchip Technology Drawing C04-061B

MCP9700/9700A and MCP9701/9701A

5-Lead Plastic Small Outline Transistor (LT) [SC70]

Note: For the most current package drawings, please see the Microchip Packaging Specification located at <http://www.microchip.com/packaging>

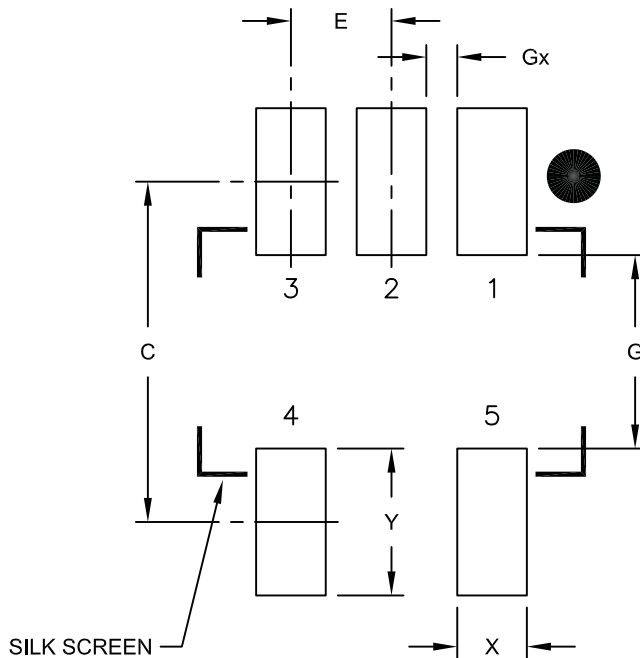

RECOMMENDED LAND PATTERN

Dimension Limits	Units	MILLIMETERS		
		MIN	NOM	MAX
Contact Pitch	E	0.65 BSC		
Contact Pad Spacing	C		2.20	
Contact Pad Width	X			0.45
Contact Pad Length	Y			0.95
Distance Between Pads	G	1.25		
Distance Between Pads	Gx	0.20		

Notes:

1. Dimensioning and tolerancing per ASME Y14.5M

BSC: Basic Dimension. Theoretically exact value shown without tolerances.

Microchip Technology Drawing No. C04-2061A

MCP9700/9700A and MCP9701/9701A

3-Lead Plastic Small Outline Transistor (TT) [SOT-23]

Note: For the most current package drawings, please see the Microchip Packaging Specification located at <http://www.microchip.com/packaging>

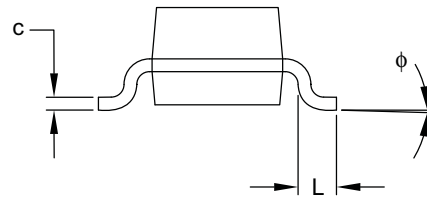
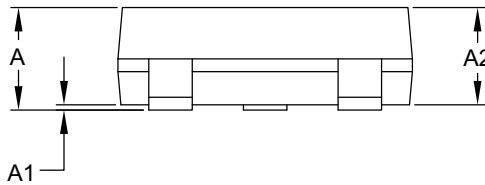
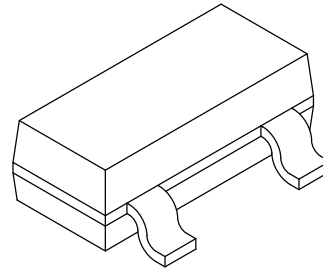
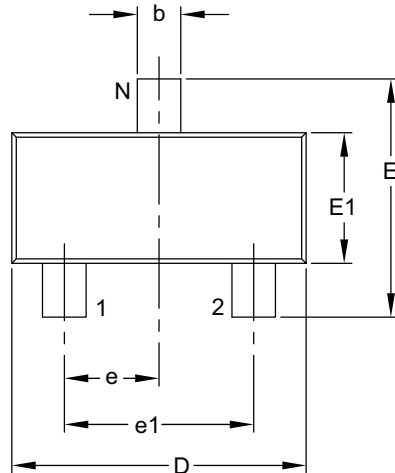

Dimension Limits	Units	MILLIMETERS		
		MIN	NOM	MAX
Number of Pins	N	3		
Lead Pitch	e	0.95 BSC		
Outside Lead Pitch	e1	1.90 BSC		
Overall Height	A	0.89	–	1.12
Molded Package Thickness	A2	0.79	0.95	1.02
Standoff	A1	0.01	–	0.10
Overall Width	E	2.10	–	2.64
Molded Package Width	E1	1.16	1.30	1.40
Overall Length	D	2.67	2.90	3.05
Foot Length	L	0.13	0.50	0.60
Foot Angle	ϕ	0°	–	10°
Lead Thickness	c	0.08	–	0.20
Lead Width	b	0.30	–	0.54

Notes:

- Dimensions D and E1 do not include mold flash or protrusions. Mold flash or protrusions shall not exceed 0.25 mm per side.
- Dimensioning and tolerancing per ASME Y14.5M.
BSC: Basic Dimension. Theoretically exact value shown without tolerances.

Microchip Technology Drawing C04-104B

MCP9700/9700A and MCP9701/9701A

3-Lead Plastic Small Outline Transistor (TT) [SOT-23]

Note: For the most current package drawings, please see the Microchip Packaging Specification located at <http://www.microchip.com/packaging>

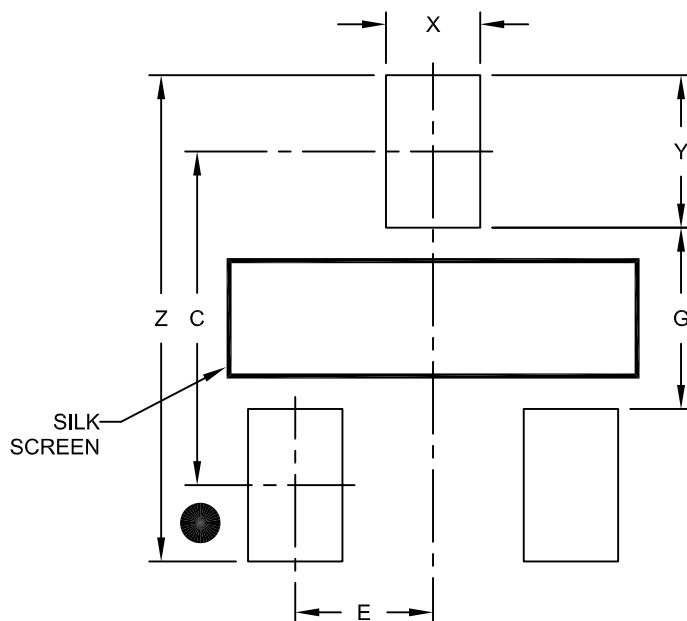

RECOMMENDED LAND PATTERN

Dimension Limits	Units	MILLIMETERS		
		MIN	NOM	MAX
Contact Pitch	E	0.95 BSC		
Contact Pad Spacing	C		2.30	
Contact Pad Width (X3)	X			0.65
Contact Pad Length (X3)	Y			1.05
Distance Between Pads	G	1.25		
Overall Width	Z			3.35

Notes:

1. Dimensioning and tolerancing per ASME Y14.5M

BSC: Basic Dimension. Theoretically exact value shown without tolerances.

Microchip Technology Drawing No. C04-2104A

MCP9700/9700A and MCP9701/9701A

3-Lead Plastic Transistor Outline (TO) [TO-92]

Note: For the most current package drawings, please see the Microchip Packaging Specification located at <http://www.microchip.com/packaging>

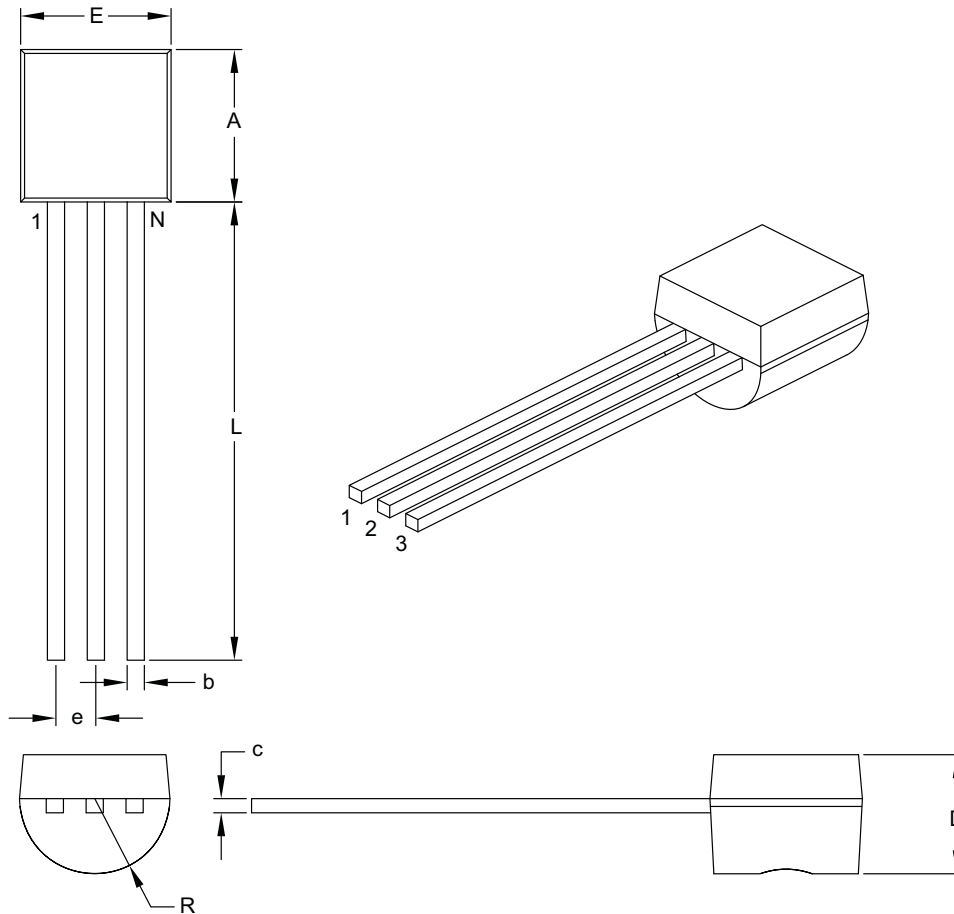

Dimension Limits	Units	INCHES	
		MIN	MAX
Number of Pins	N	3	
Pitch	e	.050 BSC	
Bottom to Package Flat	D	.125	.165
Overall Width	E	.175	.205
Overall Length	A	.170	.210
Molded Package Radius	R	.080	.105
Tip to Seating Plane	L	.500	–
Lead Thickness	c	.014	.021
Lead Width	b	.014	.022

Notes:

- Dimensions A and E do not include mold flash or protrusions. Mold flash or protrusions shall not exceed .005" per side.
- Dimensioning and tolerancing per ASME Y14.5M.
BSC: Basic Dimension. Theoretically exact value shown without tolerances.

Microchip Technology Drawing C04-101B

MCP9700/9700A and MCP9701/9701A

NOTES:

MCP9700/9700A and MCP9701/9701A

APPENDIX A: REVISION HISTORY

Revision A (November 2005)

- Original release of this document.

Revision G (June 2016)

The following is the list of modifications:

1. Added the MCP9700T-H/TT package version.
2. Minor typographical changes.

Revision F (July 2014)

The following is the list of modifications:

3. Updated the Package Type information.
4. Note 4 in the DC Electrical Characteristics table was added.
5. Updated the Temperature Range in the Product Identification System section.
6. Added maximum IDD specification for the High Temperature device.

Revision E (April 2009)

The following is the list of modifications:

1. Added High Temperature option throughout document.
2. Updated plots to reflect the high temperature performance.
3. Updated Package Outline drawings.
4. Updated Revision history.

Revision D (October 2007)

The following is the list of modifications:

1. Added the 3-lead SOT-23 devices to data sheet.
2. Replaced Figure 2-15.
3. Updated Package Outline Drawings.

Revision C (June 2006)

The following is the list of modifications:

1. Added the MCP9700A and MCP9701A devices to data sheet.
2. Added TO92 package for the MCP9700/MCP9701.

Revision B (October 2005)

The following is the list of modifications:

1. Added **Section 3.0 “Pin Descriptions”**.
2. Added the Linear Active Thermistor™ IC trademark.
3. Removed the 2nd order temperature equation and the temperature coefficient histogram.
4. Added a reference to AN1001 and corresponding verbiage.
5. Added Figure 4-2 and corresponding verbiage.

MCP9700/9700A and MCP9701/9701A

NOTES:

MCP9700/9700A and MCP9701/9701A

PRODUCT IDENTIFICATION SYSTEM

To order or obtain information, e.g., on pricing or delivery, refer to the factory or the listed sales office.

<u>PART NO.</u>	<u>X⁽¹⁾</u>	<u>-X</u>	<u>/XX</u>	Examples:
Device	Tape and Reel Option	Temperature Range	Package	
<p>Device: MCP9700: Linear Active Thermistor™ IC MCP9700A: Linear Active Thermistor™ IC MCP9701: Linear Active Thermistor™ IC MCP9701A: Linear Active Thermistor™ IC</p> <p>Tape and Reel: T = Tape and Reel ⁽¹⁾ Blank = Tube</p> <p>Temperature Range: E = -40°C to +125°C (Extended Temperature) H = -40°C to +150°C (High Temperature) (MCP9700, SOT-23-3 and SC70-5 only)</p> <p>Package: LT = Plastic Small Outline Transistor, 5-lead TO = Plastic Transistor Outline, 3-lead TT = Plastic Small Outline Transistor, 3-lead</p>				<p>a) MCP9700T-E/LT: Linear Active Thermistor IC Tape and Reel Extended temperature 5LD SC70 package</p> <p>b) MCP9700-E/TO: Linear Active Thermistor IC Extended temperature 3LD TO-92 package</p> <p>c) MCP9700T-E/TT: Linear Active Thermistor IC Tape and Reel Extended temperature 3LD SOT-23 package</p> <p>d) MCP9700T-H/LT: Linear Active Thermistor IC Tape and Reel High temperature 5LD SC70 package</p> <p>a) MCP9700AT-E/LT: Linear Active Thermistor IC Tape and Reel Extended temperature 5LD SC70 package</p> <p>b) MCP9700A-E/TO: Linear Active Thermistor IC Extended temperature 3LD TO-92 package</p> <p>c) MCP9700AT-E/TT: Linear Active Thermistor IC Tape and Reel Extended temperature 3LD SOT-23 package</p> <p>a) MCP9701T-E/LT: Linear Active Thermistor IC Tape and Reel Extended temperature 5LD SC70 package</p> <p>b) MCP9701-E/TO: Linear Active Thermistor IC Extended temperature 3LD TO-92 package</p> <p>c) MCP9701T-E/TT: Linear Active Thermistor IC Tape and Reel Extended temperature 3LD SOT-23 package</p> <p>a) MCP9701AT-E/LT: Linear Active Thermistor IC Tape and Reel Extended temperature 5LD SC70 package</p> <p>b) MCP9701A-E/TO: Linear Active Thermistor IC Extended temperature 3LD TO-92 package</p> <p>c) MCP9701AT-E/TT: Linear Active Thermistor IC Tape and Reel Extended Temperature 3LD SOT-23 package</p> <p>a) MCP9700T-H/TT: Linear Active Thermistor IC Tape and Reel High Temperature 3LD SOT-23 package</p> <p>b) MCP9700T-H/LT: Linear Active Thermistor IC Tape and Reel High Temperature 5LD SC70 package</p> <p>Note 1: Tape and Reel identifier only appears in the catalog part number description. This identifier is used for ordering purposes and is not printed on the device package. Check with your Microchip Sales Office for package availability with the Tape and Reel option.</p>

MCP9700/9700A and MCP9701/9701A

NOTES:

Note the following details of the code protection feature on Microchip devices:

- Microchip products meet the specification contained in their particular Microchip Data Sheet.
- Microchip believes that its family of products is one of the most secure families of its kind on the market today, when used in the intended manner and under normal conditions.
- There are dishonest and possibly illegal methods used to breach the code protection feature. All of these methods, to our knowledge, require using the Microchip products in a manner outside the operating specifications contained in Microchip's Data Sheets. Most likely, the person doing so is engaged in theft of intellectual property.
- Microchip is willing to work with the customer who is concerned about the integrity of their code.
- Neither Microchip nor any other semiconductor manufacturer can guarantee the security of their code. Code protection does not mean that we are guaranteeing the product as “unbreakable.”

Code protection is constantly evolving. We at Microchip are committed to continuously improving the code protection features of our products. Attempts to break Microchip's code protection feature may be a violation of the Digital Millennium Copyright Act. If such acts allow unauthorized access to your software or other copyrighted work, you may have a right to sue for relief under that Act.

Information contained in this publication regarding device applications and the like is provided only for your convenience and may be superseded by updates. It is your responsibility to ensure that your application meets with your specifications. MICROCHIP MAKES NO REPRESENTATIONS OR WARRANTIES OF ANY KIND WHETHER EXPRESS OR IMPLIED, WRITTEN OR ORAL, STATUTORY OR OTHERWISE, RELATED TO THE INFORMATION, INCLUDING BUT NOT LIMITED TO ITS CONDITION, QUALITY, PERFORMANCE, MERCHANTABILITY OR FITNESS FOR PURPOSE. Microchip disclaims all liability arising from this information and its use. Use of Microchip devices in life support and/or safety applications is entirely at the buyer's risk, and the buyer agrees to defend, indemnify and hold harmless Microchip from any and all damages, claims, suits, or expenses resulting from such use. No licenses are conveyed, implicitly or otherwise, under any Microchip intellectual property rights unless otherwise stated.

Microchip received ISO/TS-16949:2009 certification for its worldwide headquarters, design and wafer fabrication facilities in Chandler and Tempe, Arizona; Gresham, Oregon and design centers in California and India. The Company's quality system processes and procedures are for its PIC® MCUs and dsPIC® DSCs, KEELoC® code hopping devices, Serial EEPROMs, microperipherals, nonvolatile memory and analog products. In addition, Microchip's quality system for the design and manufacture of development systems is ISO 9001:2000 certified.

**QUALITY MANAGEMENT SYSTEM
CERTIFIED BY DNV
= ISO/TS 16949 =**

Trademarks

The Microchip name and logo, the Microchip logo, AnyRate, dsPIC, FlashFlex, flexPWR, Heldo, JukeBlox, KeeLoq, KeeLoq logo, Klear, LANCheck, LINK MD, MediaLB, MOST, MOST logo, MPLAB, OptoLyzer, PIC, PICSTART, PIC32 logo, RightTouch, SpyNIC, SST, SST Logo, SuperFlash and UNI/O are registered trademarks of Microchip Technology Incorporated in the U.S.A. and other countries.

ClockWorks, The Embedded Control Solutions Company, ETHERSYNCH, Hyper Speed Control, HyperLight Load, IntelliMOS, mTouch, Precision Edge, and QUIET-WIRE are registered trademarks of Microchip Technology Incorporated in the U.S.A.

Analog-for-the-Digital Age, Any Capacitor, AnyIn, AnyOut, BodyCom, chipKIT, chipKIT logo, CodeGuard, dsPICDEM, dsPICDEM.net, Dynamic Average Matching, DAM, ECAN, EtherGREEN, In-Circuit Serial Programming, ICSP, Inter-Chip Connectivity, JitterBlocker, KlearNet, KlearNet logo, MiWi, motorBench, MPASM, MPF, MPLAB Certified logo, MPLIB, MPLINK, MultiTRAK, NetDetach, Omniscient Code Generation, PICDEM, PICDEM.net, PICkit, PICtail, PureSilicon, RightTouch logo, REAL ICE, Ripple Blocker, Serial Quad I/O, SQL, SuperSwitcher, SuperSwitcher II, Total Endurance, TSHARC, USBCheck, VariSense, ViewSpan, WiperLock, Wireless DNA, and ZENA are trademarks of Microchip Technology Incorporated in the U.S.A. and other countries.

SQTP is a service mark of Microchip Technology Incorporated in the U.S.A.

Silicon Storage Technology is a registered trademark of Microchip Technology Inc. in other countries.

GestIC is a registered trademarks of Microchip Technology Germany II GmbH & Co. KG, a subsidiary of Microchip Technology Inc., in other countries.

All other trademarks mentioned herein are property of their respective companies.

© 2005-2016, Microchip Technology Incorporated, Printed in the U.S.A., All Rights Reserved.

ISBN: 978-1-5224-0666-2



MICROCHIP

Worldwide Sales and Service

AMERICAS

Corporate Office
2355 West Chandler Blvd.
Chandler, AZ 85224-6199
Tel: 480-792-7200
Fax: 480-792-7277
Technical Support:
<http://www.microchip.com/support>
Web Address:
www.microchip.com

Atlanta
Duluth, GA
Tel: 678-957-9614
Fax: 678-957-1455

Austin, TX
Tel: 512-257-3370

Boston
Westborough, MA
Tel: 774-760-0087
Fax: 774-760-0088

Chicago
Itasca, IL
Tel: 630-285-0071
Fax: 630-285-0075

Cleveland
Independence, OH
Tel: 216-447-0464
Fax: 216-447-0643

Dallas
Addison, TX
Tel: 972-818-7423
Fax: 972-818-2924

Detroit
Novi, MI
Tel: 248-848-4000

Houston, TX
Tel: 281-894-5983

Indianapolis
Noblesville, IN
Tel: 317-773-8323
Fax: 317-773-5453

Los Angeles
Mission Viejo, CA
Tel: 949-462-9523
Fax: 949-462-9608

New York, NY
Tel: 631-435-6000

San Jose, CA
Tel: 408-735-9110

Canada - Toronto
Tel: 905-673-0699
Fax: 905-673-6509

ASIA/PACIFIC

Asia Pacific Office
Suites 3707-14, 37th Floor
Tower 6, The Gateway
Harbour City, Kowloon

Hong Kong
Tel: 852-2943-5100
Fax: 852-2401-3431

Australia - Sydney
Tel: 61-2-9868-6733
Fax: 61-2-9868-6755

China - Beijing
Tel: 86-10-8569-7000
Fax: 86-10-8528-2104

China - Chengdu
Tel: 86-28-8665-5511
Fax: 86-28-8665-7889

China - Chongqing
Tel: 86-23-8980-9588
Fax: 86-23-8980-9500

China - Dongguan
Tel: 86-769-8702-9880

China - Hangzhou
Tel: 86-571-8792-8115
Fax: 86-571-8792-8116

China - Hong Kong SAR
Tel: 852-2943-5100
Fax: 852-2401-3431

China - Nanjing
Tel: 86-25-8473-2460
Fax: 86-25-8473-2470

China - Qingdao
Tel: 86-532-8502-7355
Fax: 86-532-8502-7205

China - Shanghai
Tel: 86-21-5407-5533
Fax: 86-21-5407-5066

China - Shenyang
Tel: 86-24-2334-2829
Fax: 86-24-2334-2393

China - Shenzhen
Tel: 86-755-8864-2200
Fax: 86-755-8203-1760

China - Wuhan
Tel: 86-27-5980-5300
Fax: 86-27-5980-5118

China - Xian
Tel: 86-29-8833-7252
Fax: 86-29-8833-7256

ASIA/PACIFIC

China - Xiamen
Tel: 86-592-2388138
Fax: 86-592-2388130

China - Zhuhai
Tel: 86-756-3210040
Fax: 86-756-3210049

India - Bangalore
Tel: 91-80-3090-4444
Fax: 91-80-3090-4123

India - New Delhi
Tel: 91-11-4160-8631
Fax: 91-11-4160-8632

India - Pune
Tel: 91-20-3019-1500

Japan - Osaka
Tel: 81-6-6152-7160
Fax: 81-6-6152-9310

Japan - Tokyo
Tel: 81-3-6880-3770
Fax: 81-3-6880-3771

Korea - Daegu
Tel: 82-53-744-4301
Fax: 82-53-744-4302

Korea - Seoul
Tel: 82-2-554-7200
Fax: 82-2-558-5932 or
82-2-558-5934

Malaysia - Kuala Lumpur
Tel: 60-3-6201-9857
Fax: 60-3-6201-9859

Malaysia - Penang
Tel: 60-4-227-8870
Fax: 60-4-227-4068

Philippines - Manila
Tel: 63-2-634-9065
Fax: 63-2-634-9069

Singapore
Tel: 65-6334-8870
Fax: 65-6334-8850

Taiwan - Hsin Chu
Tel: 886-3-5778-366
Fax: 886-3-5770-955

Taiwan - Kaohsiung
Tel: 886-7-213-7828

Taiwan - Taipei
Tel: 886-2-2508-8600
Fax: 886-2-2508-0102

Thailand - Bangkok
Tel: 66-2-694-1351
Fax: 66-2-694-1350

EUROPE

Austria - Wels
Tel: 43-7242-2244-39
Fax: 43-7242-2244-393

Denmark - Copenhagen
Tel: 45-4450-2828
Fax: 45-4485-2829

France - Paris
Tel: 33-1-69-53-63-20
Fax: 33-1-69-30-90-79

Germany - Dusseldorf
Tel: 49-2129-3766400

Germany - Karlsruhe
Tel: 49-721-625370

Germany - Munich
Tel: 49-89-627-144-0
Fax: 49-89-627-144-44

Italy - Milan
Tel: 39-0331-742611
Fax: 39-0331-466781

Italy - Venice
Tel: 39-049-7625286

Netherlands - Drunen
Tel: 31-416-690399
Fax: 31-416-690340

Poland - Warsaw
Tel: 48-22-3325737

Spain - Madrid
Tel: 34-91-708-08-90
Fax: 34-91-708-08-91

Sweden - Stockholm
Tel: 46-8-5090-4654

UK - Wokingham
Tel: 44-118-921-5800
Fax: 44-118-921-5820

07/14/15

X-ON Electronics

Largest Supplier of Electrical and Electronic Components

Click to view similar products for [Board Mount Temperature Sensors](#) category:

Click to view products by [Microchip](#) manufacturer:

Other Similar products are found below :

[5962-8757102XA](#) [66F115](#) [EMC1063-1-ACZL-TR](#) [NCT218FCT2G](#) [O53GAB175A-160Y](#) [3610085020002](#) [389049M9527](#) [MIKROE-912](#)
[ADM1023ARQZ-REEL](#) [ADM1032ARMZ-1RL](#) [AT30TS74-U1FMBB-T](#) [AT30TS74-U1FMAB-T](#) [AT30TS74-U1FMCB-T](#) [AT30TS74-](#)
[U1FMDB-T](#) [ADT7483AARQZ-RL](#) [ADT7481ARMZ-REEL](#) [ADT7463ARQZ-REEL](#) [MCP98243T-BE/MC](#) [66L080-0226](#) [5962-8757103XA](#)
[S-58LM20A-I4T1U](#) [NCT375MNR2G](#) [LM84CIMQA](#) [CAT34TS00VP2GT4A](#) [NCT80DBR2G](#) [SEN-16304](#) [GX21M15](#) [GX122](#) [NST175H-](#)
[QSPR](#) [TC6501P065VCTTR](#) [AT-1U](#) [MCP9700AT-E/LT](#) [MCP9701-E/TO](#) [MCP9803-M/MS](#) [MCP9701A-E/TO](#) [LM57FEPWQ1](#) [LM57FPW](#)
[LM57FSPWQ1](#) [60-41123102-0150.0010](#) [60-43123102-0150.0010](#) [60-53123102-0150.0010](#) [MLX90615SSG-DAA-000-TU](#) [TMP303CDRLR](#)
[TC6501P055VCTTR](#) [TC6503P005VCTTR](#) [ADT7311WTRZ-RL](#) [ADT7311WTRZ-RL7](#) [ADT7473ARQZ-REEL](#) [LM335AM](#)
[LM335AM/NOPB](#)