



# MIC1344

## Smart, 3A, Two-Channel, Power ORing Switch

### General Description

The MIC1344 is an advanced two input, one output, hot swappable, power multiplexer. It has both automatic and manual input selection (ENA and ENB) and four status outputs.

In automatic mode, the MIC1344 will automatically connect the higher of two input voltages (INA or INB), to the output (OUT). In manual mode, either of the two inputs can be routed to the output, or both power inputs can be turned off so that multiple MIC1344's can be used for more than two power inputs.

The MIC1344 has four digital open drain status outputs. The ASEL and BSEL outputs indicate which input is selected. The STAOK and STBOK outputs indicate the general health of the input channels. Specifically, these outputs will be inactive (high) if the channel has sufficient input voltage, the channel current is within acceptable limits, the die temperature is not too hot, and the channel has no reverse current detected.

The current limit for each input channel of the MIC1344 can be individually set up to 3A, by two external current-limit set resistors (ILIMA and ILMIB). The current flowing in each of the channels can be read by measuring the voltage at these resistors.

Datasheets and support documentation are available on Micrel's web site at: [www.micrel.com](http://www.micrel.com).

### Features

- Two input, one output, power ORing switch
- Input voltage operating range: 2.8V to 5.5V
- Automatic and manual input selection modes
- Four digital and two analog status outputs
- Current blocking: output-to-input and input-to-input
- Low on-resistance (70mΩ typical)
- Up to 3A current handling
- Low standby channel current (11µA typical)
- Separate current limiting and readback for each channel
- Available in 12-pin, 2mm x 2mm, QFN (FTQFN) package
- Thermal-shutdown protection
- -40°C to 125°C junction temperature range

### Applications

- Two input to one output power selector
- Multiple inputs to a single output power selector
- Charger input power selector
- Dual battery selector
- Main and backup power selector
- USB power selector
- Portable products
- Supercapacitor ORing
- Backup battery diode ORing

### Typical Application

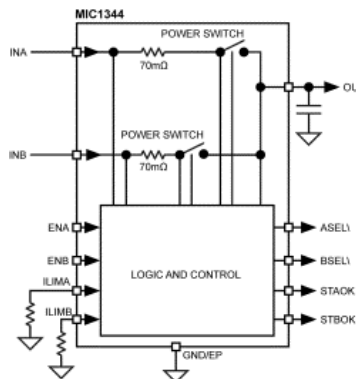

## Ordering Information

Part Number	Marking	Output Current	Junction Temperature Range	Package <sup>(1, 2)</sup>
MIC1344YFT	4N	Adjustable (3.0A maximum)	-40°C to +125°C	12-Pin 2mm x 2mm FTQFN

### Notes:

- Pin 1 indicator = "▲"
- Green RoHS compliant package. Lead finish is NiPdAu. Mold compound is halogen free.

## Pin Configuration

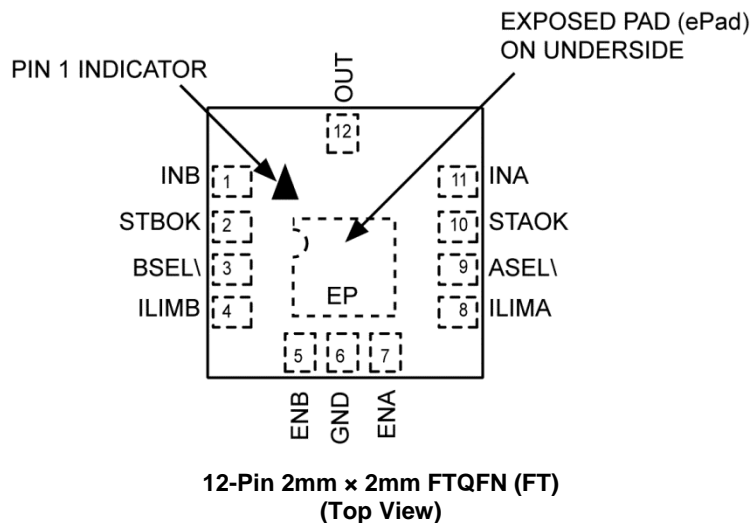

## Pin Description

Pin Number	Pin Name	Pin Function
1	INB	Supply Voltage Input B. This input may be bypassed to GND with >0.1μF, X7R or similar, ceramic type capacitor. This input is hot swappable.
2	STBOK	Open drain output, digital status monitor for supply voltage Input B (INB). Voltage will be low if any of the following conditions occur: <ul style="list-style-type: none"> <li>INB is below the UVLO limit.</li> <li>The output current from INB is at its set current limit.</li> <li>The die temperature exceeds the overtemperature limit.</li> <li>Reverse current detected (<math>V_{OUT} &gt; V_{INB} + 100\text{mV}</math>).</li> <li>Prolonged high hysteresis mode engaged.</li> </ul>
3	BSEL\	Open Drain Output. Low if Input B (INB) is providing power to the OUT pin.
4	ILIMB	A resistor from this pin to ground sets the current limit for INB. The current flowing into INB can be monitored by the voltage on this pin.
5	ENB	The ENA and ENB digital inputs control which voltage input (INA or INB) is connected to the voltage out (OUT) pin. There is an internal 570kΩ pull-down on this pin to ensure that automatic select mode is active when the logic that is driving the MIC1344 is being powered up. <a href="#">Table 1</a> shows how to control the power routing with the ENA and ENB inputs.
6	GND	Ground.

**Pin Description (Continued)**

Pin Number	Pin Name	Pin Function
7	ENA	The ENA and ENB digital inputs control which voltage input (INA or INB) is connected to the voltage out (OUT) pin. There is an internal 570kΩ pull-down on this pin to ensure that automatic select mode is active when the logic that is driving the MIC1344 is being powered-up. <a href="#">Table 1</a> shows how to control the power routing with the ENA and ENB inputs.
8	ILIMA	A resistor from this pin to ground sets the current limit for INA. The current flowing into INA can be monitored by the voltage on this pin.
9	ASEL\	Open Drain Output. Low if Input A (INA) is providing power to the OUT pin.
10	STAOK	Open drain output, digital status monitor for supply voltage Input A (INA). Voltage will be low if any of the following conditions occur: <ul style="list-style-type: none"> <li>• INA is below the UVLO limit.</li> <li>• The output current from INA is at its set current limit.</li> <li>• The die temperature exceeds the overtemperature limit.</li> <li>• Reverse current detected (<math>V_{OUT} &gt; V_{INA} + 100\text{mV}</math>).</li> <li>• Prolonged high hysteresis mode engaged.</li> </ul>
11	INA	Supply Voltage Input A. This input may be bypassed to GND with $>0.1\mu\text{F}$ , X7R or similar, ceramic type capacitor. This input is hot swappable.
12	OUT	Voltage Output. This is the power output. Bypass this pin to ground with a capacitor suitable to provide adequate power during the switchover time of the MIC1344. This capacitor should be a minimum of $10\mu\text{F}$ , X7R or similar temperature stability, ceramic capacitor.
EP	ePad	Internally connected to electrical ground (GND) pin. Connect to as large a PCB area as practical to dissipate heat from the MIC1344.

### Absolute Maximum Ratings<sup>(3)</sup>

INA, INB, OUT, ENA, ENB.....	-0.3V to +6.0V
ASEL\, BSEL\, STAOK, STBOK .....	-0.3V to +6.0V
ILIMA .....	-0.3V to $V_{INA} + 0.3V$
ILIMB .....	-0.3V to $V_{INB} + 0.3V$
Power Dissipation ( $P_D$ ).....	Internally Limited <sup>(6)</sup>
Lead Temperature (soldering, 10s).....	260°C
Junction Temperature ( $T_J$ ) .....	-40°C to +125°C
Storage Temperature ( $T_S$ ).....	-65°C to +150°C
ESD Rating.....	Note 7

### Operating Ratings<sup>(4)</sup>

INA, INB <sup>(5)</sup> .....	+2.8V to +5.5V
OUT, ENA, ENB.....	0V to +5.5V
ASEL\, BSEL\, STAOK, STBOK .....	0V to +5.5V
ILIMA.....	0V to $V_{INA}$
ILIMB.....	0V to $V_{INB}$
Junction Temperature ( $T_J$ ) .....	-40°C to +125°C
Junction Thermal Resistance	
12-Pin 2mm x 2mm FTQFN:	
$\theta_{JA}$ .....	77.9°C/W
$\theta_{JC}$ .....	11.9°C/W

### Electrical Characteristics

$V_{INA}$  or  $V_{INB} = 5V$ ;  $I_{OUT} = 100mA$ ;  $C_{INA} = C_{INB} = 1\mu F$ ,  $C_{OUT} = 10\mu F$ ,  $T_J = +25^\circ C$ , **bold** values indicate junction temperature -40°C to +125°C, unless noted.

Parameter	Condition	Min.	Typ.	Max.	Units
Supply Current	Both inputs disabled, $I_{OUT} = 0A$ . Per channel.		11	<b>15</b>	$\mu A$
	One of the inputs enabled, $I_{OUT} = 0A$ .		300	<b>350</b>	
INA and INB Rising UVLO Voltage		<b>2.2</b>	2.35	<b>2.5</b>	V
UVLO Hysteresis			0.1		V
INA or INB Switch Resistance	$I_{OUT} = 500mA$ .		70	<b>200</b>	$m\Omega$
	$V_{INA}$ or $V_{INB} = 2.8V$ , $I_{OUT} = 500mA$		120	<b>220</b>	$m\Omega$
Output-to-Input Leakage Current	Leakage current of OUT to INA or INB when the corresponding input channel is turned off.		1	<b>10</b>	$\mu A$
Input-to-Input Leakage Current	Leakage current of INA to INB, or INB to INA.		1	<b>10</b>	$\mu A$
INA-to-INB or INB-to-INA Switchover Comparator Hysteresis Voltage			300		mV
ILIMA or ILIMB Output Current Accuracy (IN = 2.8V)	$R_{ILIMA}, R_{ILIMB} = 931\Omega$	<b>2.58</b>	2.85	<b>3.15</b>	A
	$R_{ILIMA}, R_{ILIMB} = 10k\Omega$	<b>0.25</b>	0.28	<b>0.31</b>	
ILIMA or ILIMB Output Current Accuracy (IN = 5.5V)	$R_{ILIMA}, R_{ILIMB} = 931\Omega$	<b>2.40</b>	2.7	<b>3.00</b>	A
	$R_{ILIMA}, R_{ILIMB} = 10k\Omega$	<b>0.20</b>	0.25	<b>0.30</b>	
INA or INB Reverse Voltage Shutdown Threshold	$V_{OUT} = 2.6V$ to $V_{INA} = 2.5V$ (with INA selected) or $V_{OUT} = 2.6V$ to $V_{INB} = 2.5V$ (with INB selected)		100		mV
INA or INB Reverse Voltage Shutdown Hysteresis	$V_{OUT}$ falling		50		mV

**Notes:**

- Exceeding the absolute maximum ratings may damage the device.
- The device is not guaranteed to function outside its operating ratings.
- INA and INB can be taken to 0V; however the minimum operating voltage is 2.8V.
- The maximum allowable power dissipation of any  $T_A$  (ambient temperature) is  $P_{D(MAX)} = (T_{J(MAX)} - T_A) / \theta_{JA}$ . Exceeding the maximum allowable power dissipation will result in excessive die temperature, and the MIC1344 will go into thermal shutdown.
- Devices are ESD sensitive. Handling precautions recommended. Human Body Model (HBM) is 1.5k $\Omega$  in series with 100pF. Machine Model (MM), is 200pF, per JESD 22-A115.

## Electrical Characteristics (Continued)

$V_{INA}$  or  $V_{INB} = 5V$ ;  $I_{OUT} = 100mA$ ;  $C_{INA} = C_{INB} = 1\mu F$ ,  $C_{OUT} = 10\mu F$ ,  $T_J = +25^\circ C$ , **bold** values indicate junction temperature  $-40^\circ C$  to  $+125^\circ C$ , unless noted.

Parameter	Condition	Min.	Typ.	Max.	Units
ILIMA or ILIMB Current-Limit Onset Threshold Voltage <sup>(8)</sup>	$R_{ILIMA}, R_{ILIMB} = 10k\Omega$	<b>1.10</b>	1.20	<b>1.30</b>	V
$V_{ILIMA}$ or $V_{ILIMB}$ for Low-Current	$V_{INA}$ or $V_{INB} = 3.5V$ , $I_{OUT} = 20mA$	<b>15</b>	100	<b>185</b>	mV
INA or INB High-Load Shutdown Response Time <sup>(9)</sup>	$I_{OUT} = 0mA$ to $R_{OUT} = 0.1\Omega$ (turn off transition time, no load to high-current load)		1.5		$\mu s$
Automatic Mode Switchover Delay Time <sup>(10)</sup>	Automatic mode, $V_{INA} + 300mV \geq V_{INB}$ or $V_{INB} + 300mV \geq V_{INA}$		5	<b>10</b>	$\mu s$
INA-to-INB Manual Mode Switchover Delay Time <sup>(11)</sup>	Time from INB selected to $V_{OUT} = 90\%$ of $V_{INB}$ voltage $V_{INA} = 0V$ , $V_{INB} = 5V$		350	<b>700</b>	$\mu s$
INB-to-INA Manual Mode Switchover Delay Time <sup>(11)</sup>	Time from INA selected to $V_{OUT} = 90\%$ of $V_{INA}$ voltage $V_{INA} = 5V$ , $V_{INB} = 0V$		350	<b>700</b>	$\mu s$
Switch Off Delay Time <sup>(12)</sup>	Automatic mode, INA or INB selected to No Input Selected. $R_{OUT} = 10\Omega$ . No $C_{OUT}$		0.5		$\mu s$
Initial Power-Up Delay <sup>(13)</sup>	Automatic mode, INA or INB selected. $R_{OUT} = 10\Omega$ , $V_{INA}$ or $V_{INB}$ transitions from 0V to 5V		0.3	<b>1</b>	ms
ENA or ENB Input Resistance			570		k $\Omega$
5V ENA or ENB Logic Level Low Voltage	Voltage falling. $V_{INA}$ or $V_{INB} = 5V$ .		1.20	<b>1.05</b>	V
3V ENA or ENB Logic Level Low Voltage	Voltage falling. $V_{INA}$ or $V_{INB} = 3V$ .		0.8	<b>0.60</b>	V
5V ENA or ENB Threshold Hysteresis	$V_{INA}$ or $V_{INB} = 5V$ .		300		mV
STAOK or STBOK Active, Output Voltage	$I_{STAOK}$ or $I_{STBOK} = 10mA$		0.15	<b>0.3</b>	V
STAOK or STBOK Inactive, Leakage Current	$V_{STAOK}$ or $V_{STBOK} = 5V$ (leakage current to GND)		1		$\mu A$
ASEL\ or BSEL\ Active, Output Voltage	$I_{ASEL\}$ or $I_{BSEL\} = 10mA$		0.15	<b>0.3</b>	V
ASEL\ or BSEL\ Inactive, Leakage Current	$V_{ASEL\}$ or $V_{BSEL\} = 5V$ (leakage current to GND)		1		$\mu A$
Overtemperature Shutdown Temperature Threshold	Junction temperature increasing		150		$^\circ C$
Overtemperature Shutdown Hysteresis			20		$^\circ C$

### Notes:

- The current-limit threshold onset voltage is the voltage on ILIM (A or B) that corresponds to the onset of the output current regulation for the corresponding input channel.
- The time it takes for the output current on either INA or INB to go from 0mA (no load) to 20% over the steady state maximum current-limit value, when a load of 0.1 $\Omega$  is applied between the OUT pin and GND.
- This is the time that the MIC1344 takes to switch between one of the two input voltages when it is in automatic mode. This is the time from when one of the input voltages goes above the other by 300mV, to the time when the output voltage reaches 90% of its final value.
- This is the time it takes to switch from one input (INA or INB) to the other (INB or INA), when in manual mode. This is the time from the ENx transition, to when the output voltage reaches 90% of its final value. (x can be either A, or B).
- This is the time from the ENA = 0, ENB = 1 transition, to when the output voltage reaches 10% of its initial value.
- This is the time between when the MIC1344 is powered up (10% of the  $V_{INA}$  or  $V_{INB}$  voltage ramp-up), to the time when the OUT voltage stabilizes to within 90% of its final value.

# Typical Characteristics

**Supply Current vs. Input Voltage**

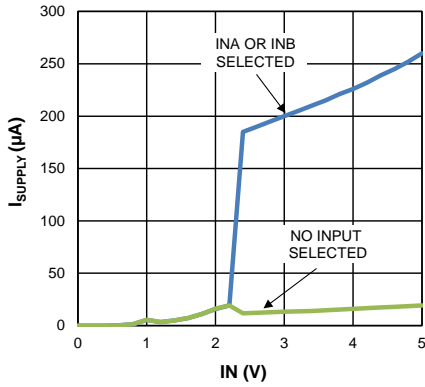

**Supply Current vs. Temperature**

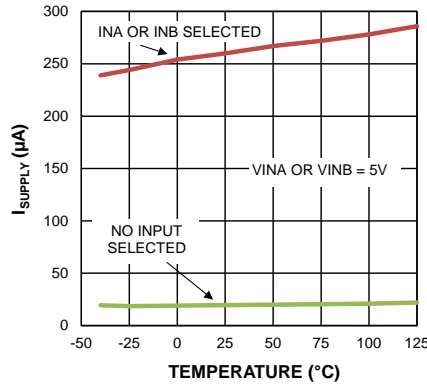

**Switch On-Resistance vs. INA or INB**

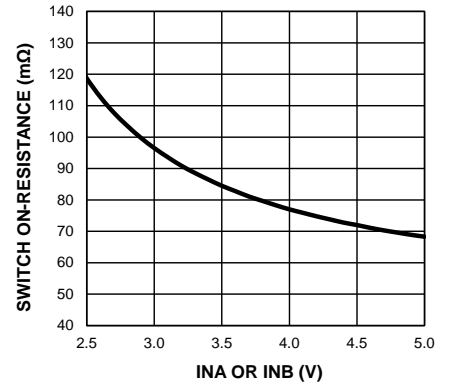

**Switch-On Resistance vs. Temperature**

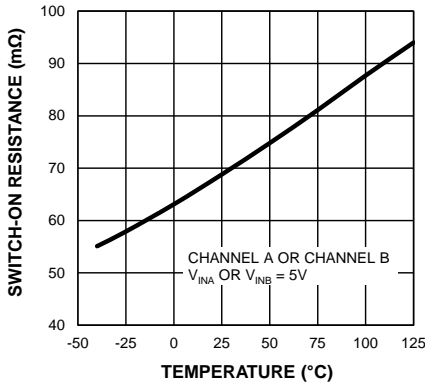

**V<sub>INA</sub> to V<sub>INB</sub> or V<sub>INB</sub> to V<sub>INA</sub> Leakage vs. Temperature**

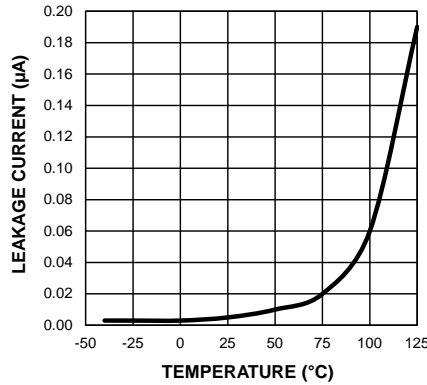

**Output to V<sub>INA</sub> or V<sub>INB</sub> Leakage vs. Temperature**

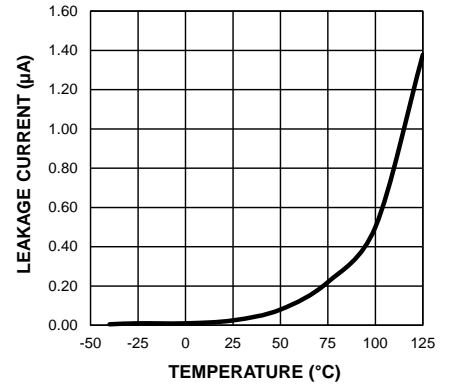

**EN On Voltage vs. IN Voltage**

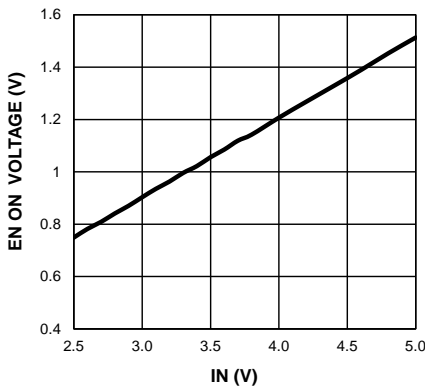

**Current Limit vs. ILIM Resistance**

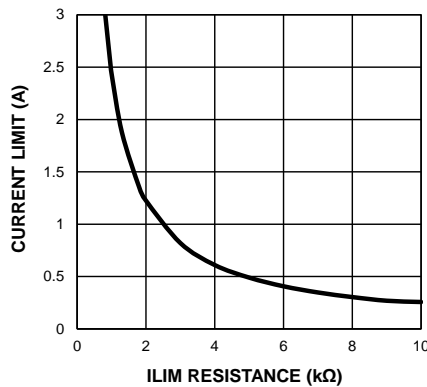

**V<sub>ILIM</sub> vs. Load Current**

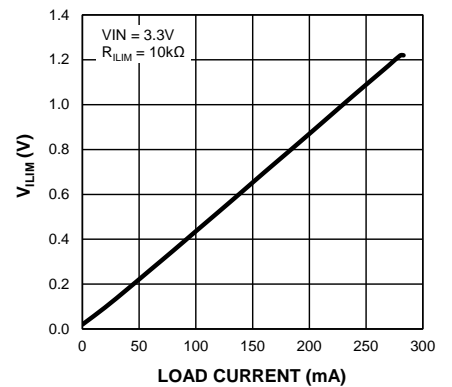

## Typical Characteristics (Continued)

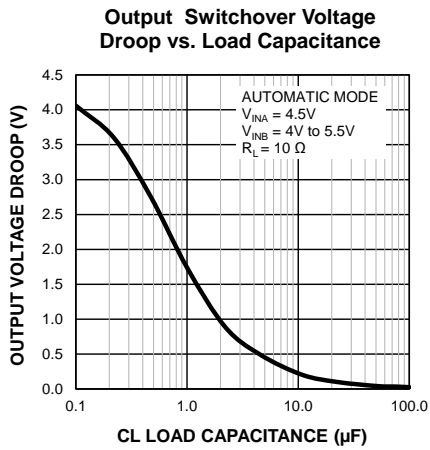
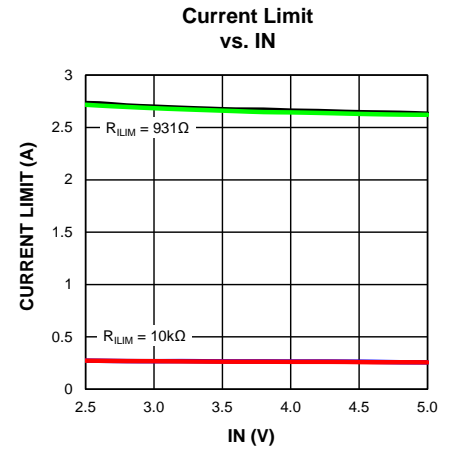
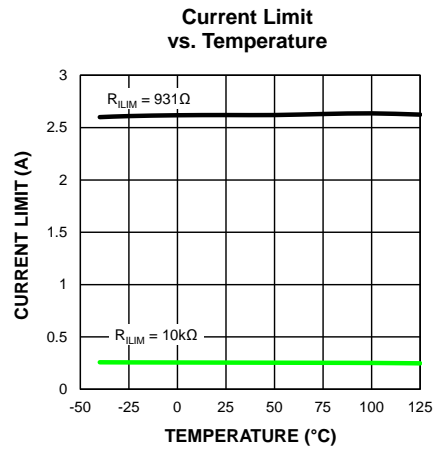
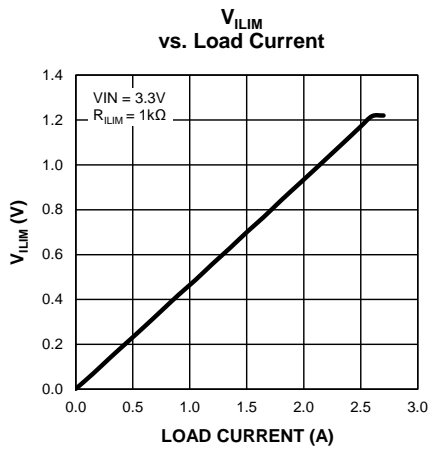

## Functional Characteristics

**Automatic Mode Selection  
(STAOK and ASEL\ Monitored)**

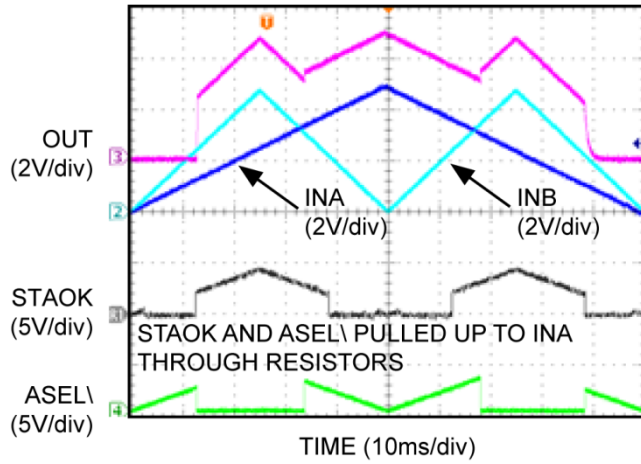

**Automatic Mode Selection  
(STBOK and BSEL\ Monitored)**

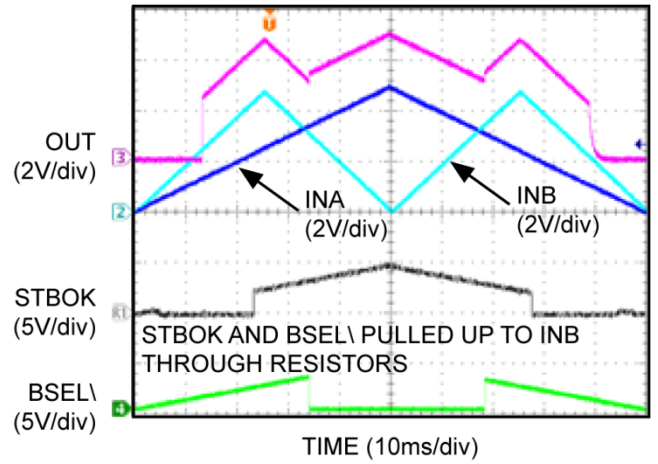

**Turn-On/Off into a 3A Load**

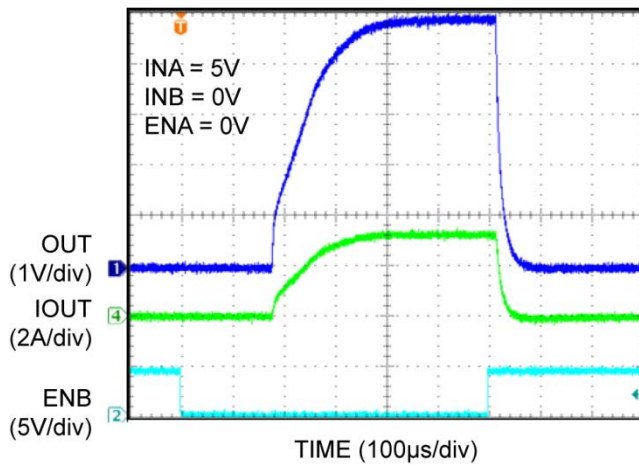

**Current-Limit Response**

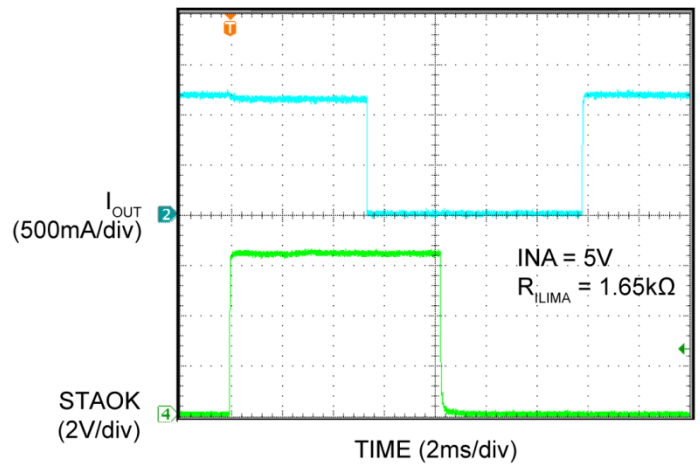



# System Connection Diagram

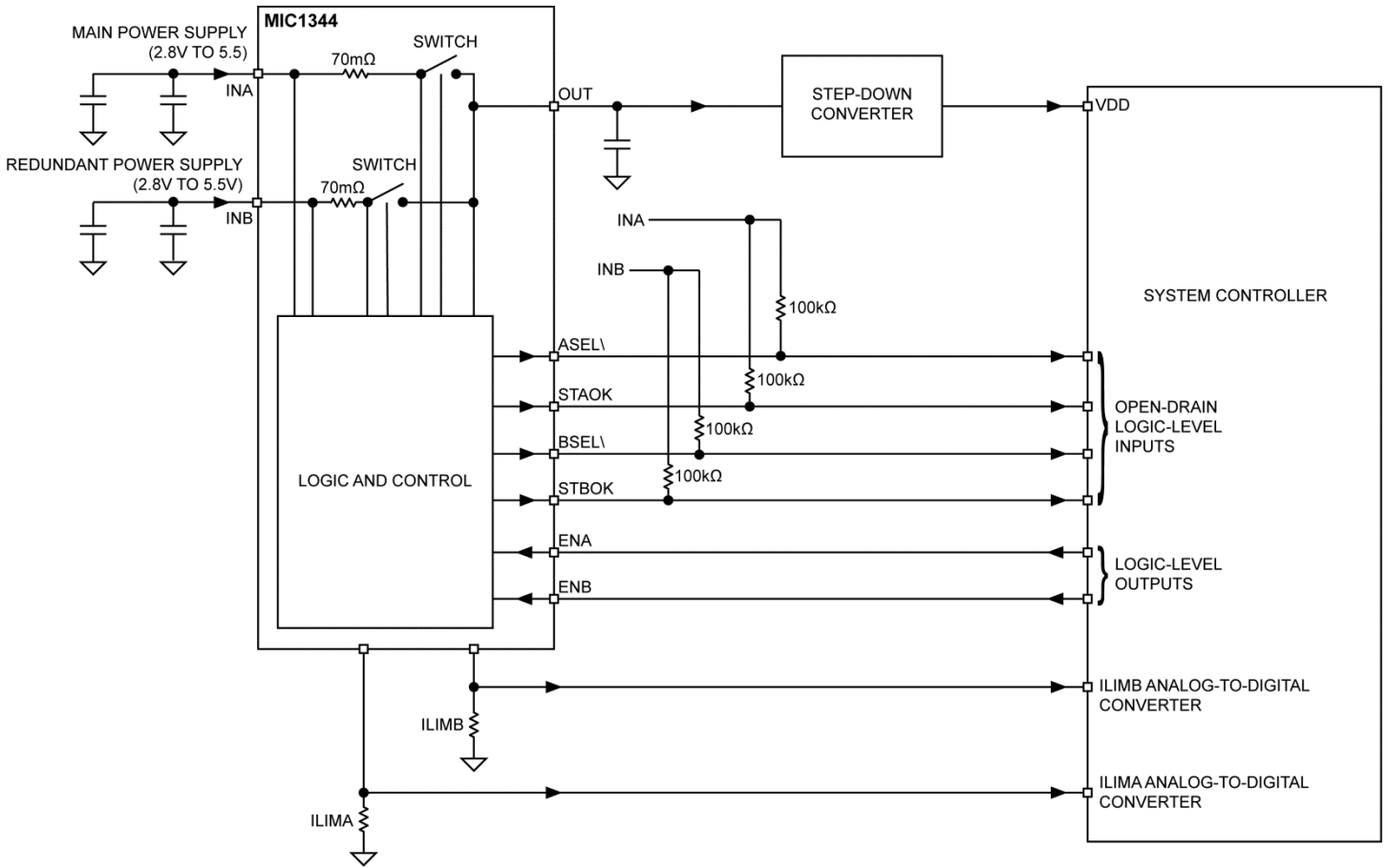

### Functional Block Diagram

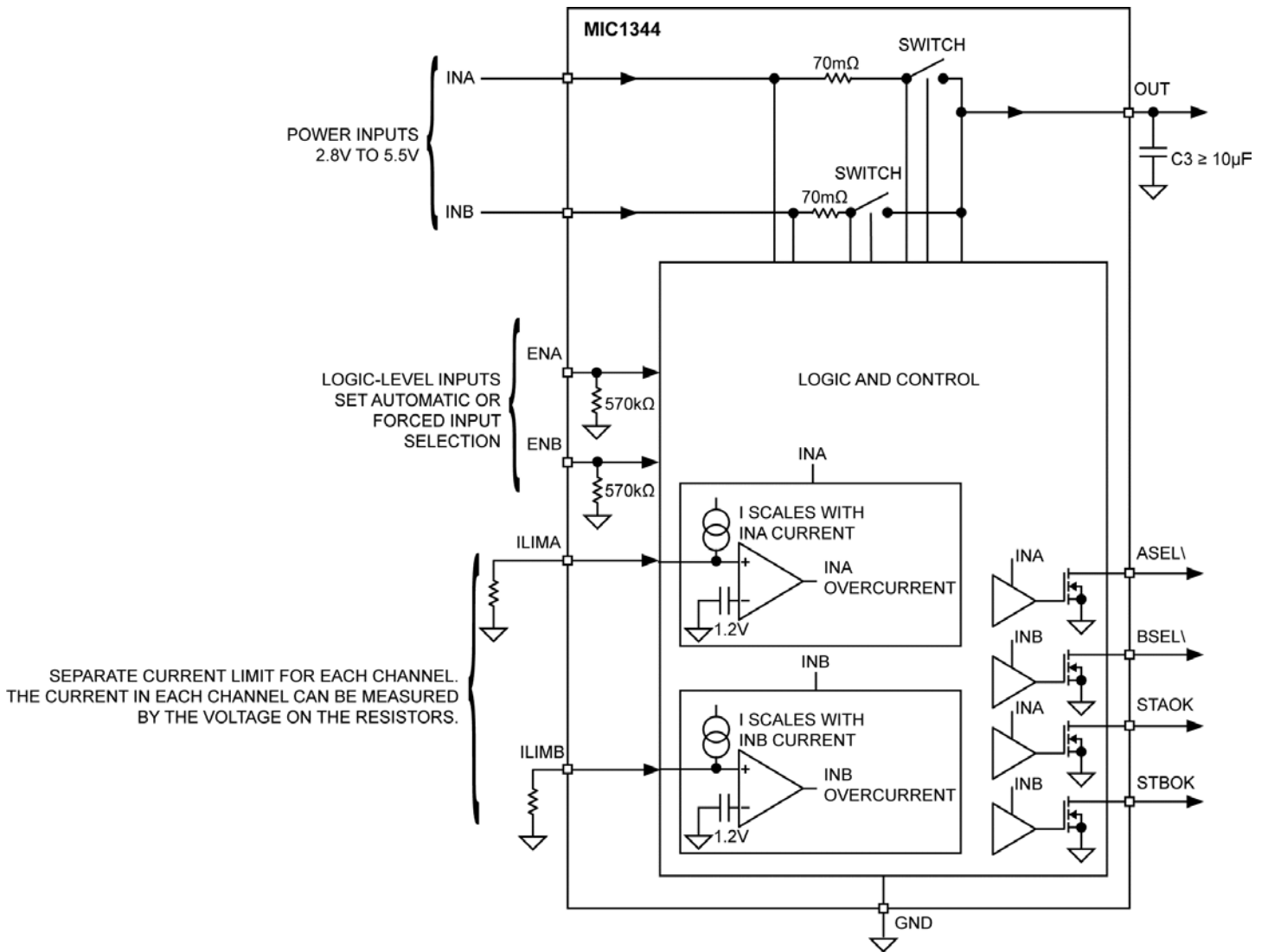

## Application Information

### Operation Overview

The MIC1344 is an advanced two input, one output, hot swappable, power multiplexer. It has both automatic and manual input selection (ENA and ENB), and four status outputs (STAOK, STBOK, ASEL, and BSEL). The following sections give a more detailed explanation regarding the application of this part.

### Channel Selection

Table 1 shows how the MIC1344 will route the input power as controlled by the ENA and ENB input pins. If a transition occurs on either ENA or ENB, the part will wait an additional 10 $\mu$ s before implementing the new code. This delay allows the two enable pins to be slightly out of sync and not cause a momentary selection of an unwanted mode.

**Table 1. ENA and ENB Input Power Selection**

ENA	ENB	Power Input Selected
0	0	Automatic mode. The higher voltage on either INA or INB automatically selected if $> V_{UVLO}$ .
0	1	No input selected (can be used for cascading other MIC1344 power inputs).
1	0	INA power input selected if $V_{INA} > V_{UVLO}$ .
1	1	INB power input selected if $V_{INB} > V_{UVLO}$ .

If the values of ENA and ENB are logic low when the MIC1344 powers up, the MIC1344 will automatically select the power input with the higher voltage and route it to the output. This is the normal power-up sequence for the MIC1344. If both inputs are below the undervoltage lockout voltage, then the output will be high impedance. If the select inputs are driven by external logic that is powered by the MIC1344, then those logic outputs can either be low or open circuit, and the MIC1344 will automatically bias up the logic when it is powered up.

Both input power sources can be turned off by putting ENA = 0, ENB = 1 on the enable input pins. One operating scenario to be aware of is that if the Logic 1 on the ENB input is generated by a device powered via the MIC1344 output, the input of the MIC1344 will be set at ENA = 0 and ENB = 0 when the power is turned off. With ENA = 0 and ENB = 0, the part will automatically select the higher of the two input voltages and turn back on again. The no input selected mode is typically used when more than two power sources are required (cascading multiple MIC1344s) and both inputs must be turned off so that the third or fourth power input can be turned on.

When no input is selected, the MIC1344 will block current flow from the output (OUT), to either input (INA or INB), as well as from either input (INA or INB) to the output (OUT).

For applications that require changing between the A and B power input with only one control line, set ENA = 1, and use the ENB input to set which of the two inputs is active.

### Current Limiting

The current limits in the two inputs of the MIC1344 can be set independently. This allows mixing input sources that have different current capacity, like a main, and backup power supply. The current limit for INA is set by the ILIMA resistor to GND, while the current limit for INB is set by the ILIMB resistor to GND. A graph of the ILIM resistance vs current limit can be found in the [Typical Characteristics](#) section of this datasheet.

The ILIM resistor value can be calculated by Equation 1:

$$R_{ILIM} = \frac{2485}{I_{CL} - 146\mu A} \quad \text{Eq. 1}$$

Where:

$I_{CL}$  = Desired current limit (A)

$R_{ILIM}$  = Resistor value for ILIM pin ( $\Omega$ )

$R_{ILIM}$  should be set between 11k $\Omega$  and 800 $\Omega$ . Setting resistor  $R_{ILIM}$  equal to zero is not recommended as it will disable current limiting.

During a current limit event, if the MIC1344 is in automatic mode, then the automatic switching will be blocked because switching over to the other channel will load it, taking its voltage low, and unloading the other channel taking its voltage high. Blocking the automatic switchover mode prevents the possible oscillation of the MIC1344 switching between the two inputs, as they become loaded by the heavy load condition. Switching the channels manually is allowed.

Current flowing in the INA or INB inputs can be measured by the voltage on the corresponding ILIM pin. These pins can be connected to the input of an analog-to-digital converter (ADC), to read the current digitally. When the voltage at the ILIM pins reaches 1.20V (typical), the MIC1344 will regulate the input current on the corresponding input to the maximum value and make the corresponding status pin (STAOK or STBOK) go active (low). The MIC1344 will hold this maximum value indefinitely or until the part overheats. Should the part

overheat, it will turn off both input channels and both status pins (STAOK and STBOK) will go active (low).

The voltage on the ILIM pin can be calculated by Equation 2:

$$V_{ILIM} = \frac{(I_{OUT} \times R_{ILIM} \times 82.1\Omega)}{(R_{ILIM} + 170k\Omega)} \quad \text{Eq. 2}$$

Where:

$I_{OUT}$  = Current out of the OUT pin (A)

$R_{ILIM}$  = Resistor value attached to the ILIM pin ( $\Omega$ )

The current limit circuit is filtered to avoid erroneous flagging of the STAOK or STBOK pins from output current spikes. The current limit must be engaged for at least greater than 50% of the time over a prolonged period of time, or constantly for at least  $\approx 5\text{ms}$  before the flag is driven low. The flag will then be held low for at least  $\approx 5\text{ms}$  after the current limit event is over, or until the current limit is engaged less than 50% of the time over a prolonged period of time.

If the MIC1344 changes between input channels that have different current limits, the load may need to be changed to accommodate the different current limit value. If there is a system controller, it would be notified of the selected INA or INB input channel through the ASEL\ and BSEL\ outputs. One example is a situation where a microprocessor runs two different programs or load sets, depending on whether the power is main (normal input power), or backup (battery, etc.).

**Digital Status Output Pins**

The MIC1344 features four digital channel status output pins, specifically STAOK, ASEL\, STBOK, and BSEL\. The power for the status pins is acquired from the corresponding input, i.e., the control power for STAOK and ASEL\ is acquired from INA with INB providing the control power for STBOK and BSEL\. The digital status pins are open drain and require pull-up resistors to function. It is recommended that the open-drain pull-up resistors be connected to the corresponding input power to ensure the indicators will be accurate below the UVLO voltage. STAOK and ASEL\ should be pulled-up to INA with STBOK and BSEL\ being pulled-up to INB. If there is no voltage at INA, the STAOK output will be high impedance. If the pull-up resistor on STAOK is connected to  $V_{INA}$ , then the STAOK will indicate the status of the input voltage correctly (see Figure 1).

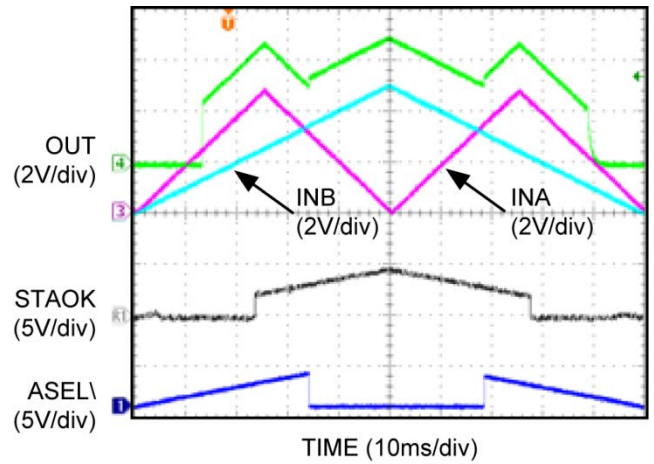

**Figure 1. STAOK Correctly Flags for Low Input Voltage when STAOK’s Pull-Up Resistor is connected to INA**

If the pull-up is connected to another voltage and INA is below the NMOS threshold, then the STAOK can falsely indicate that the input voltage is acceptable. This occurs due to the INA monitoring circuit requiring enough voltage to turn on the STAOK open-drain output transistor.

This is also true for the INB and corresponding STBOK status indicator and the ASEL\ and BSEL\ outputs (see Figure 2).

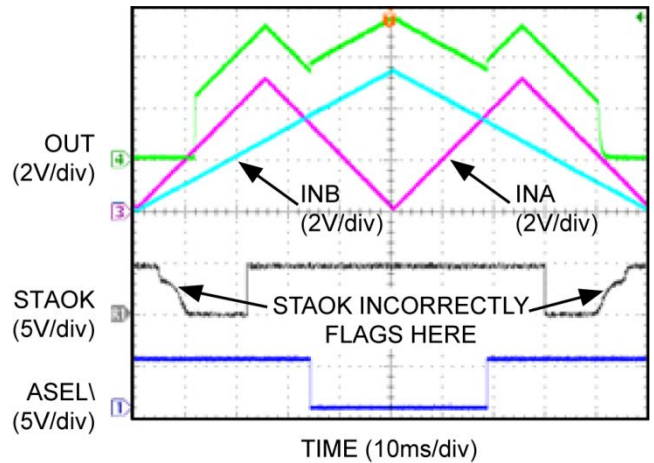

**Figure 2. STAOK Incorrectly Flags for Low Input Voltage when STAOK’s Pull-Up Resistor is connected to External 5V Supply**

The ASEL\ and BSEL\ status pins indicate which channel is selected and connected to the output. If ASEL\ is active (low), then INA is selected and if BSEL\ is active (low), then INB is selected. If both ASEL\ and BSEL\ are inactive (open-drain high), then neither of the two inputs is selected. This can occur if both INA and INB input voltages are below the undervoltage lock out (UVLO) voltage, or both inputs have been manually turned-off (ENA = 0, ENB = 1).

If high-value pull-up resistors are used (>100k $\Omega$ ), then minimal current will be injected into the digital input pins, allowing them to stay at a digital low for a lower input voltage below the UVLO voltage.

Each digital status output pin is capable of sinking 10mA, which is sufficient current to drive LEDs, optocouplers, etc. Passing the status of the MIC1344 through optocouplers allows communicating the power status across the isolation barrier of power systems.

#### Under Voltage Lockout

Both INA and INB have separate UVLO detection circuits. The UVLO status of INA is reflected on the STAOK status pin. Likewise, the UVLO status of INB is reflected on the STBOK status pin. This feature can be used to monitor the incoming voltage of the unselected input channel. If the selected IN pin is below the UVLO voltage, then the channel will be turned off, and only reverse leakage current can flow.

#### Standard Hysteresis Mode

In automatic mode, the voltage of the inactive input must be raised above the voltage of the active input by  $\approx 300\text{mV}$ , in order for the MIC1344 to switch to the inactive input.

#### High Hysteresis Mode

If four transitions between input channels occur within  $\approx 8\text{ms}$  (INA  $\rightarrow$  INB  $\rightarrow$  INA  $\rightarrow$  INB) while the part is in automatic mode, then the 300mV switchover hysteresis will increase to  $\approx 600\text{mV}$ . This is the high hysteresis mode. In the high hysteresis mode the part can only switch between channels once per millisecond. The higher hysteresis and the forced delay helps prevent the part from chattering between inputs.

In the high hysteresis mode, if there are four additional transitions in the next  $\approx 8\text{ms}$ , then the status pin for the selected channel will go low (STAOK if VINA selected and STBOK if VINB is selected).

The part will exit the high hysteresis mode if there are fewer than four transitions in a subsequent  $\approx 8\text{ms}$  period, or if a manual mode is selected.

#### Hot Swappable Inputs

The power to INA and/or INB can be connected to input power and turned on or off without consequence to the other input power supply, as long as the minimum and maximum input voltage does not exceed the ratings of the MIC1344. If the MIC1344 is set to automatic mode (ENA = 0, ENB = 0), and power is applied to one of the channels, the MIC1344 will wait until the input voltage is above the UVLO threshold, then it will wait the initial power up delay period, giving time for the input voltage to stabilize, and then connect the selected input to the OUT pin. Refer to the “[Current Limiting](#)” sub-section for details of what occurs if the INA or INB input channels current limit.

#### Cascading More than Two Input Power Sources

On the MIC1344, both inputs can be turned off using the ENA = 0, ENB = 1, no input selected mode. This mode is used when more than two power inputs are used. If there is an input voltage at either INA or INB, the corresponding digital output status pins will stay active. This allows detection of the presence of an input voltage through the corresponding STAOK or STBOK pins, even if the channel is not selected.

#### Reverse Voltage and On-Channel Voltage Detection

If one of the channels of the MIC1344 is turned off, current is blocked from flowing from the OUT pin to the unselected IN pin. For example; If INA is at 5V, and INB is selected, only a very small leakage current (<10 $\mu\text{A}$  maximum) will flow between OUT, and the unselected INB.

If a channel is turned on and the OUT voltage exceeds the corresponding IN voltage, then reverse current may flow to the input. If the voltage at the OUT pin exceeds the voltage at the correspondingly selected IN pin, then the channel will be turned off and the corresponding STAOK or STBOK pin will go active (low). For example, if INA is selected and OUT exceeds INA by  $\geq 100\text{mV}$ , then Channel A will be turned off and STAOK will go active, indicating that a fault has occurred. The same sequence occurs if Channel B is selected and OUT exceeds INB by  $\geq 100\text{mV}$ . Once the differential between OUT and the selected IN drops to  $\approx 50\text{mV}$ , the selected channel will automatically turn back on.

#### Output Capacitor

The output (OUT) requires sufficient capacitance that when the MIC1344 switches between inputs (INA or INB), that the output voltage does not unacceptably droop (go low). The cause of the output voltage drooping is that the MIC1344 switches “break before make”, which will momentarily disconnect both inputs from the output. The switchover delay is specified in the [Electrical Characteristics](#). A minimum of a 10 $\mu\text{F}$  ceramic chip capacitor is recommended on the output of the MIC1344.

**Overtemperature Shutdown**

There is one die temperature monitor for both channels of the MIC1344. If one of the two input channels causes an overtemperature condition, both channels will be shut down, and both the STAOK, STBOK outputs will be active (low impedance, logic low), indicating that a fault has occurred. If the overtemperature condition is created by one of the INA or INB channels being in an overcurrent condition, then this condition can be determined by reading the voltage on the ILIMA or ILIMB pins after the part cools down and the output recovers.

**PCB Layout Recommendations**

The MIC1344 comes in an ultra-small small 2mm × 2mm package. The part has to have sufficient PCB area, and/or air flow so that it will not overheat. Given a 3A load current, a nominal on-channel resistance of 70mΩ, a junction to ambient thermal resistance of 77.9°C/W (depends on PCB area and air flow), and an ambient temperature of 76°C, the MIC1344 die temperature will operate at the 125°C limit. The MIC1344 Evaluation Kit manual has more specifics on a recommended PCB layout for the MIC1344.

**Package Information and Recommended Landing Pattern<sup>(14)</sup>**

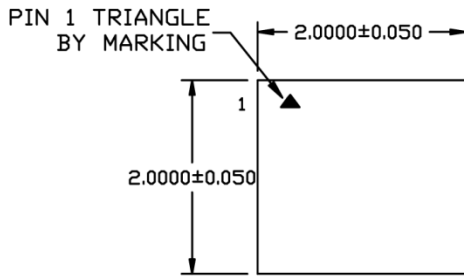

TOP VIEW  
NOTE: 1, 2, 3

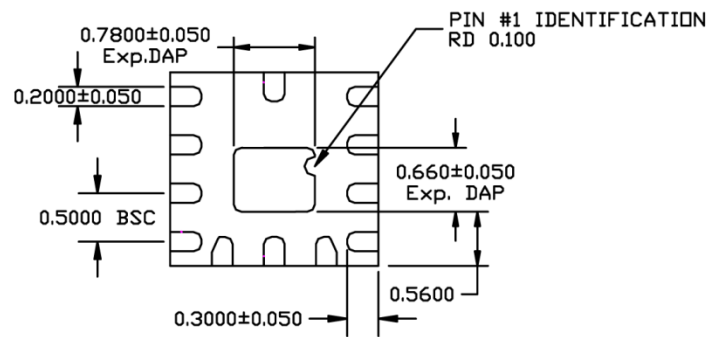

BOTTOM VIEW  
NOTE: 1, 2, 3

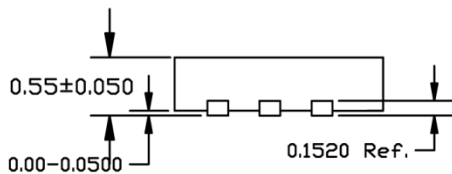

SIDE VIEW  
NOTE: 1, 2, 3

**NOTE:**

1. MAX PACKAGE WARPAGE IS 0.05 MM
2. MAX ALLOWABLE BURR IS 0.076 MM IN ALL DIRECTIONS
3. PIN #1 IS ON TOP WILL BE LASER MARKED
4. GREEN COLORED RECTANGLES (SHADED AREA) REPRESENT SOLDER STENCIL OPENING ON EXPOSED METAL TRACE.
5. RED CIRCLE IN LAND PATTERN REPRESENT THERMAL VIA. RECOMMENDED SIZE IS 0.20 MM DIAMETER, 0.40 MM PITCH AND SHOULD BE CONNECTED TO GND FOR MAX THERMAL PERFORMANCE
6. PURPLE HIDDEN LINES ARE RECOMMENDED METAL TRACE/GND PLANES FOR IMPROVED THERMAL PERFORMANCE

**12-Pin 2mm x 2mm FTQFN (FT)**

**Note:**

14. Package information is correct as of the publication date. For updates and most current information, go to [www.micrel.com](http://www.micrel.com).





---

**MICREL, INC. 2180 FORTUNE DRIVE SAN JOSE, CA 95131 USA**  
TEL +1 (408) 944-0800 FAX +1 (408) 474-1000 WEB <http://www.micrel.com>

Micrel, Inc. is a leading global manufacturer of IC solutions for the worldwide high performance linear and power, LAN, and timing & communications markets. The Company's products include advanced mixed-signal, analog & power semiconductors; high-performance communication, clock management, MEMs-based clock oscillators & crystal-less clock generators, Ethernet switches, and physical layer transceiver ICs. Company customers include leading manufacturers of enterprise, consumer, industrial, mobile, telecommunications, automotive, and computer products. Corporation headquarters and state-of-the-art wafer fabrication facilities are located in San Jose, CA, with regional sales and support offices and advanced technology design centers situated throughout the Americas, Europe, and Asia. Additionally, the Company maintains an extensive network of distributors and reps worldwide.

Micrel makes no representations or warranties with respect to the accuracy or completeness of the information furnished in this datasheet. This information is not intended as a warranty and Micrel does not assume responsibility for its use. Micrel reserves the right to change circuitry, specifications and descriptions at any time without notice. No license, whether express, implied, arising by estoppel or otherwise, to any intellectual property rights is granted by this document. Except as provided in Micrel's terms and conditions of sale for such products, Micrel assumes no liability whatsoever, and Micrel disclaims any express or implied warranty relating to the sale and/or use of Micrel products including liability or warranties relating to fitness for a particular purpose, merchantability, or infringement of any patent, copyright, or other intellectual property right.

Micrel Products are not designed or authorized for use as components in life support appliances, devices or systems where malfunction of a product can reasonably be expected to result in personal injury. Life support devices or systems are devices or systems that (a) are intended for surgical implant into the body or (b) support or sustain life, and whose failure to perform can be reasonably expected to result in a significant injury to the user. A Purchaser's use or sale of Micrel Products for use in life support appliances, devices or systems is a Purchaser's own risk and Purchaser agrees to fully indemnify Micrel for any damages resulting from such use or sale.

© 2015 Micrel, Incorporated.

## X-ON Electronics

Largest Supplier of Electrical and Electronic Components

*Click to view similar products for [Hot Swap Voltage Controllers](#) category:*

*Click to view products by [Microchip](#) manufacturer:*

Other Similar products are found below :

[LTC4227CUFD-4#PBF](#) [LTC4212IMS](#) [ADM1075-2ARUZ-RL7](#) [LM5067MW-1/NOPB](#) [ADM1075-1ARUZ-RL7](#) [MAX5969BETB+T](#)  
[MIC22700YML-TR](#) [LTC4223CDHD-1#PBF](#) [MAX40200AUK+T](#) [LTC4224IDDB-2#TRMPBF](#) [LT1640LIS8#PBF](#) [LTC4217CDHC-12#PBF](#)  
[LT1640ALCS8#PBF](#) [LT4294HDD#PBF](#) [LTC4253CGN#PBF](#) [LTC4211CMS8#PBF](#) [LTC4230CGN#PBF](#) [LTC4224IMS-1#PBF](#)  
[LTC4216IMS#PBF](#) [LTC4212IMS#PBF](#) [LTC4260CGN#PBF](#) [LTC4227CGN-2#PBF](#) [LTC4244IGN#PBF](#) [LTC4212CMS#PBF](#)  
[LT4250HCN8#PBF](#) [ADM1276-3ACPZ-RL](#) [LTC4226IUD-1#PBF](#) [LT1640AHCN8](#) [ADM1075-2ACPZ](#) [ADM1075-1ACPZ](#) [ADM1073ARUZ](#)  
[ADM1073ARUZ-REEL7](#) [ADM1075-1ARUZ](#) [ADM1075-2ARUZ](#) [ADM1170-1AUJZ-RL7](#) [ADM1171-2AUJZ-RL7](#) [ADM1172-1AUJZ-RL7](#)  
[ADM1172-2AUJZ-RL7](#) [ADM1176-1ARMZ-R7](#) [ADM1177-1ARMZ-R7](#) [ADM1177-2ARMZ-R7](#) [ADM1178-1ARMZ-R7](#) [ADM1275-3ARQZ](#)  
[ADM1275-1ARQZ](#) [ADM1275-3ARQZ-R7](#) [ADM1276-3ACPZ](#) [ADM1278-1BCPZ](#) [ADM4210-1AUJZ-RL7](#) [ADM1275-2ARQZ](#)  
[ADM1070ARTZ-REEL7](#)