

General Description

The MIC2210 is a dual μ Cap, low dropout regulator with an open-drain driver and power-on reset circuit. The first regulator is capable of sourcing 150mA, while the second regulator can source up to 300mA and includes a power-on reset function. The open-drain output is capable of sinking 150mA for LED backlighting applications.

Ideal for battery operated applications, the MIC2210 offers 1% accuracy, extremely low dropout voltage (80mV @ 100mA), and extremely low ground current, only 48 μ A total. Equipped with a TTL logic compatible enable pin*, the MIC2210 can be put into a zero-off-mode current state, drawing no current when disabled.

The MIC2210 is a μ Cap design, operating with very small ceramic output capacitors for stability, reducing required board space and component cost.

The MIC2210 is available in fixed output voltages in the 10-pin 3mm \times 3mm MLF[®] leadless package.

Data sheets and support documentation can be found on Micrel's web site at www.micrel.com.

*For each output.

Features

- Input voltage range: 2.25V to 5.5V
- Stable with ceramic output capacitor
- 2 LDO outputs
 - Output 1 - 150mA output current
 - Output 2 - 300mA output current
- 1 Open-drain driver
- Low dropout voltage of 80mV @ 100mA
- Ultra-low quiescent current of 48 μ A
- High output accuracy:
 - +1.0% initial accuracy
 - +2.0% over temperature
- Thermal shutdown protection
- Current limit protection
- Tiny 10-pin 3mm \times 3mm MLF[®] package

Applications

- Cellular/PCS phones
- Wireless modems
- PDAs

Typical Application

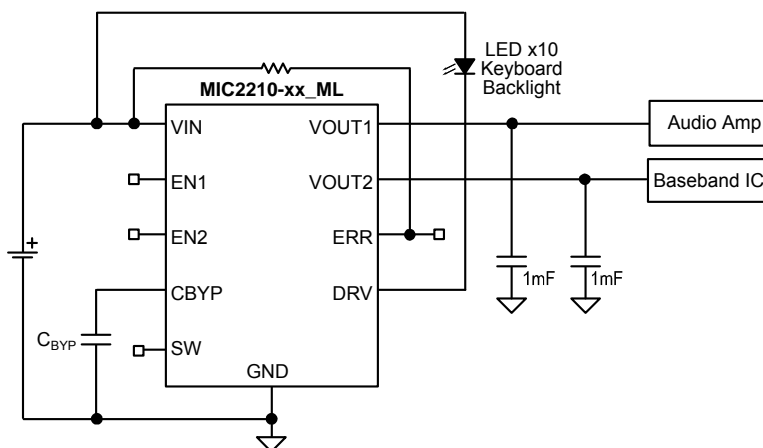

MIC2210 Typical Cell Phone Application

Ordering Information

Part Number			Voltage* (Vo1/Vo2)	Junction Temp. Range	Package
Full	Manufacturing	Pb-Free			
MIC2210-1.5/2.8BML	MIC2210-FMBML	MIC2210-FMYML	1.5V/2.8V	-40° to +125°C	10-Pin 3x3 MLF [®]
MIC2210-1.8/3.3BML	MIC2210-GSBML	MIC2210-GSYML	1.8V/3.3V	-40° to +125°C	10-Pin 3x3 MLF [®]
MIC2210-2.8/1.6BML	MIC2210-MWBML	MIC2210-MWYML	2.8V/1.6V	-40° to +125°C	10-Pin 3x3 MLF [®]
MIC2210-2.8/3.0BML	MIC2210-MPBML	MIC2210-MPYML	2.8V/3.0V	-40° to +125°C	10-Pin 3x3 MLF [®]
MIC2210-3.0/3.3BML	MIC2210-PSBML	MIC2210-PSYML	3.0V/3.3V	-40° to +125°C	10-Pin 3x3 MLF [®]
MIC2210-3.3/3.3BML	MIC2210-SSBML	MIC2210-SSYML	3.3V/3.3V	-40° to +125°C	10-Pin 3x3 MLF [®]

* For other output voltage options, contact Micrel for details.

Voltage	Code
Adj.	A
1.5	F
1.6	W
1.8	G
1.85	D
1.9	Y
2.0	H
2.1	E
2.5	J
2.6	K
2.7	L
2.8	M
2.85	N
2.9	O
3.0	P
3.1	Q
3.2	R
3.3	S
3.4	T
3.5	U
3.6	V

Table 1. Voltage Codes

Pin Configuration

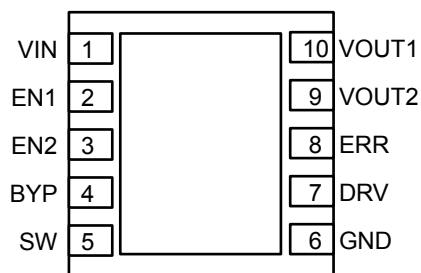

**10-Pin 3mm x 3mm MLF[®] (ML)
(Top View)**

Pin Description

Pin Number	Pin Name	Pin Function
1	VIN	Supply Input: (VIN1 and VIN2 are internally tied together.)
2	EN1	Enable Input to Regulator 1: Enables regulator 1 output. Active high input. High = on, low = off. Do not leave floating.
3	EN2	Enable Input to Regulator 2: Enables regulator 2 output. Active high input. High = on, low = off. Do not leave floating.
4	CBYP	Reference Bypass: Connect external 0.01 μ F to GND to reduce output noise. May be left open.
5	SW	Active high signal drives open-drain N-channel MOSFET.
6	GND	Ground: Connect externally to Exposed Pad.
7	DRV	Open-Drain Output: Capable of sinking 150mA.
8	ERR	Error Flag Output: Open-drain output. Active low indicates an output undervoltage condition on regulator 2.
9	VOUT2	Output of Regulator 2: 300mA output current.
10	VOUT1	Output of Regulator 1: 150mA output current.
EP	GND	Ground: Internally connected to the Exposed Pad. Connect externally to pin 6.

Absolute Maximum Ratings⁽¹⁾

Supply Voltage (V_{IN})	0V to 7V
Enable Voltage (V_{EN})	0V to 7V
Power Dissipation (P_D)	Internally Limited ⁽³⁾
Lead Temperature (soldering, 5 sec.)	260°C
Junction Temperature (T_J)	-40°C to +125°C
Storage Temperature (T_S)	-65°C to +150°C

Operating Ratings⁽²⁾

Supply Voltage (V_{IN})	2.25V to 5.5V
Enable Voltage (V_{EN})	0V to V_{IN}
Junction Temperature (T_J)	-40°C to +125°C
Package Thermal Resistance	
MLF-10 (θ_{JA}) 1" square 2oz. copper	60°C/W

Electrical Characteristics⁽⁴⁾

$V_{IN} = V_{OUT} + 1V$ for higher output of the regulator pair; $C_{OUT} = 1\mu F$, $I_{OUT} = 100\mu A$; $T_J = 25^\circ C$, **bold** values indicate $-40^\circ C \leq T_J \leq +125^\circ C$, unless noted.

Parameter	Condition	Min	Typ	Max	Units
Output Voltage Accuracy	Variation from nominal V_{OUT}	-1 -2		+1 +2	% %
Output Voltage Temp. Coefficient			40		ppm/C
Line Regulation; Note 5	$V_{IN} = V_{OUT} + 1V$ to 5.5V	-0.3 -0.6	0.02	+0.3 +0.6	%/V %/V
Load Regulation	$I_{OUT} = 100\mu A$ to 150mA (Regulator 1 and 2)		0.2	1	%
	$I_{OUT} = 100\mu A$ to 300mA (Regulator 2)			1.5	%
Dropout Voltage; Note 6	$I_{OUT} = 150mA$ (Regulator 1 and 2)		120	190 250	mV mV
	$I_{OUT} = 300mA$ (Regulator 2)		240	340 420	mV mV
Ground Pin Current	$I_{OUT1} = I_{OUT2} = 0\mu A$		48	65 80	μA μA
	$I_{OUT1} = 150mA$ & $I_{OUT2} = 300mA$		60		μA
Ground Pin Current in Shutdown	$V_{EN} \leq 0.4V$			2	μA
Ripple Rejection	$f = 1kHz$; $C_{OUT} = 1.0\mu F$ ceramic; $C_{BYP} = 10nF$		60		dB
	$f = 20kHz$; $C_{OUT} = 1.0\mu F$ ceramic; $C_{BYP} = 10nF$		40		dB
Current Limit	$V_{OUT} = 0V$ (Regulator 1)	150	280	460	mA
	$V_{OUT} = 0V$ (Regulator 2)	300	450	700	mA
Output Voltage Noise	$C_{OUT} = 1\mu F$, $C_{BYP} = 0.01\mu F$, 10Hz to 100kHz		30		μV_{rms}
Enable Output					
Enable Input Voltage	Logic Low (Regulator Shutdown)			0.6	V
	Logic High (Regulator Enabled)	1.8			V
Enable Input Current	$V_{IL} < 0.6V$ (Regulator Shutdown)	-1	0.01	+1	μA
	$V_{IH} > 1.8V$ (Regulator Enabled)	-1	0.01	+1	μA
ERROR Flag Output (LDO2)					
VERR	Low Threshold, % of nominal V_{OUT2} (Flag ON)	90			%
	High Threshold, % of nominal V_{OUT2} (Flag OFF)			96	%
VOL	Flag Output Logic Low Voltage; $I_L = 100\mu A$		0.02	0.1	mV
IERR	Flag Leakage Current, Flag OFF	-1	0.01	+1	μA

Parameter	Condition	Min	Typ	Max	Units
DRV Output					
Voltage Low	$I_{DRV} = 150\text{mA}$		0.2	0.5 0.6	V
Leakage Current	$I_{DRV} = 0\text{mA}$, $V_{DRV} = 5.5\text{V}$, $\text{SW} = 0\text{V}$	-1	0.01	+1	μA
SW Input Voltage	Logic Low (DRV Shutdown)			0.6	V
	Logic High (DRV Enabled)	1.8			V
SW Input Current	$V_{IL} < 0.6\text{V}$ (DRV Shutdown)	-1	0.01	+1	μA
	$V_{IH} > 1.8\text{V}$ (DRV Enabled)	-1	0.01	+1	μA

Notes:

1. Exceeding the absolute maximum rating may damage the device.
2. The device is not guaranteed to function outside its operating rating.
3. The maximum allowable power dissipation of any T_A (ambient temperature) is $(P_{D(max)} = T_{J(max)} - T_A) / \theta_{JA}$. Exceeding the maximum allowable power dissipation will result in excessive die temperature, and the regulator will go into thermal shutdown.
4. Specification for packaged product only.
5. Minimum input for line regulation test is set to $V_{OUT} + 1\text{V}$ relative to the highest output voltage.
6. Dropout voltage is defined as the input-to-output differential at which the output voltage drops 2% below its nominal value measured at 1V differential. For outputs below 2.25V, dropout voltage is the input-to-output voltage differential with the minimum input voltage 2.25V. Minimum input operating voltage is 2.25V.

Typical Characteristics

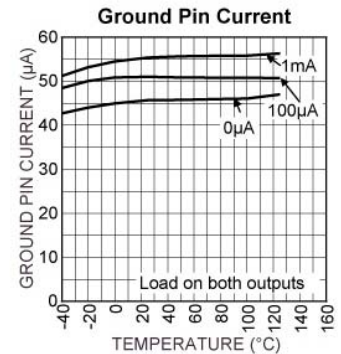
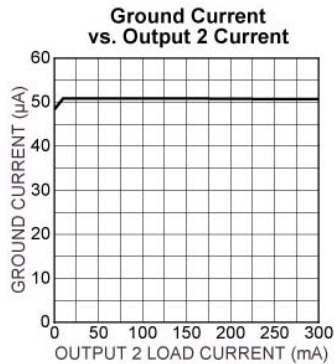
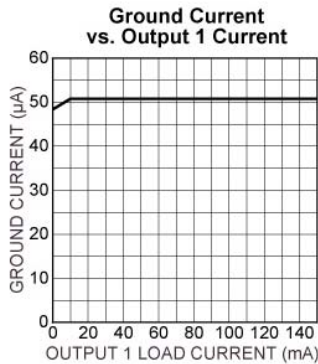
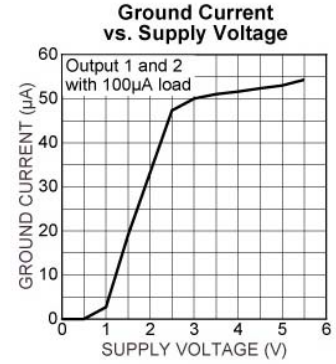
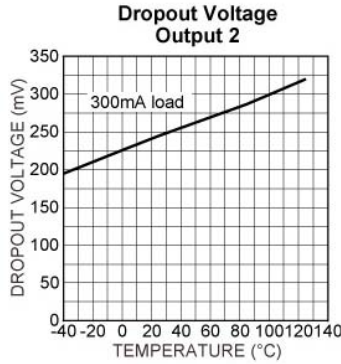
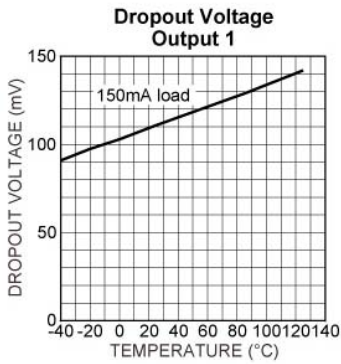
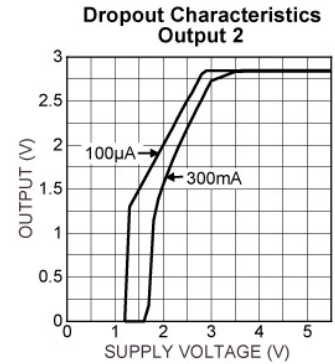
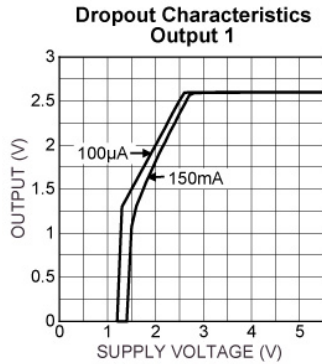
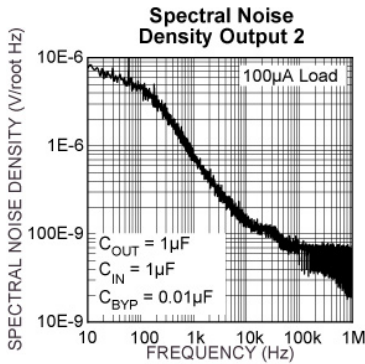
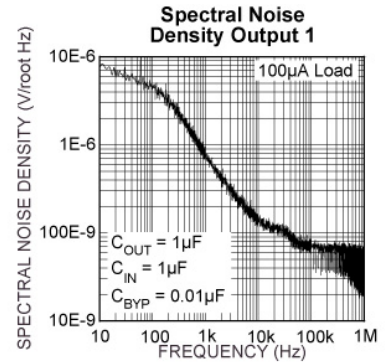
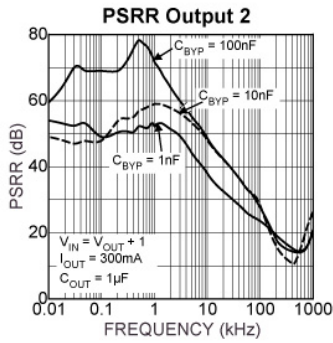
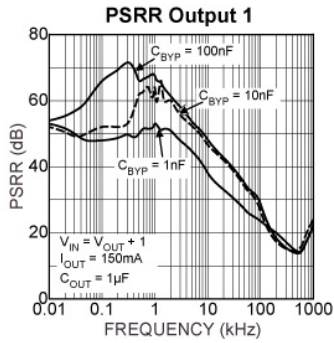

Typical Characteristics (cont.)

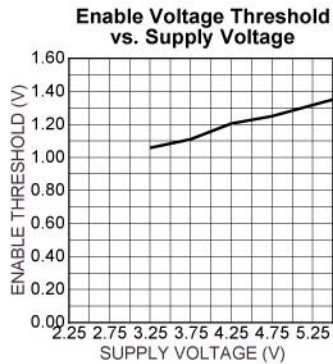
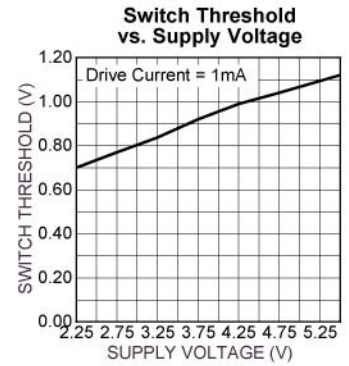
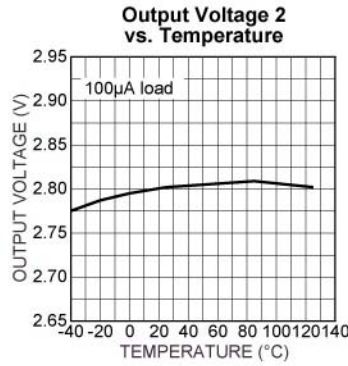
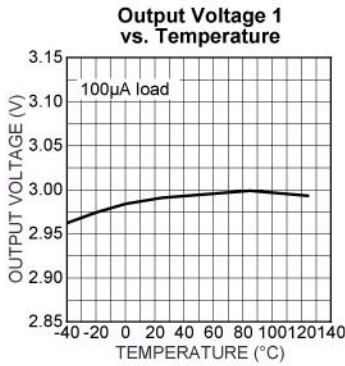
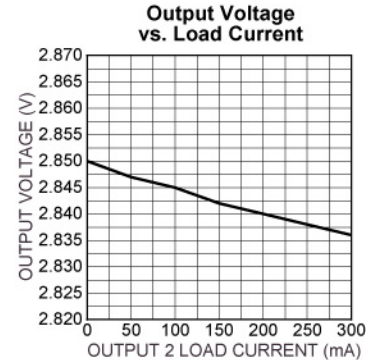
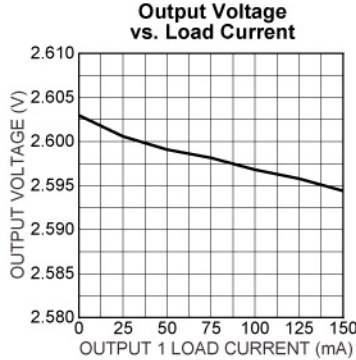
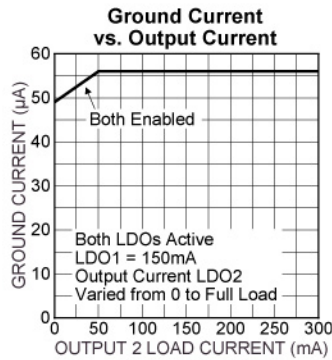
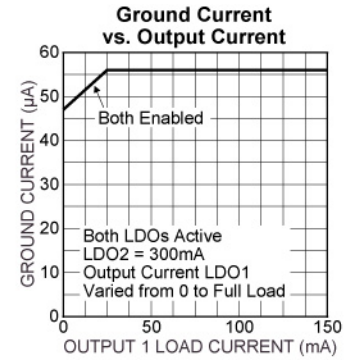
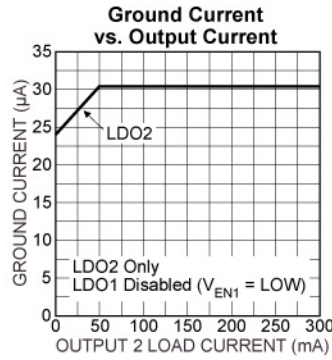
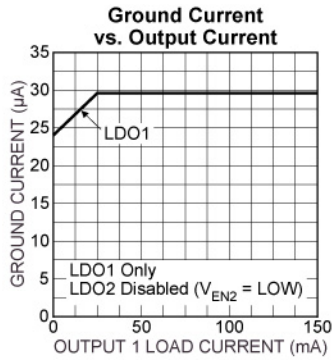

Functional Characteristics

Enable Characteristics

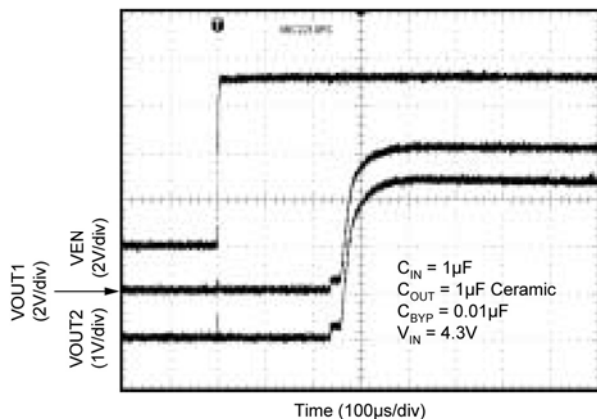

Load Transient Response (LDO 1)

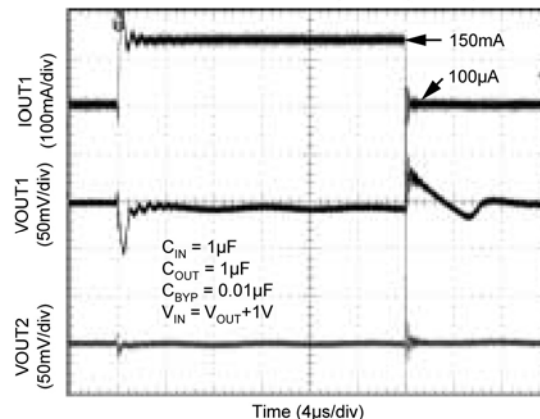

Load Transient Response (LDO 2)

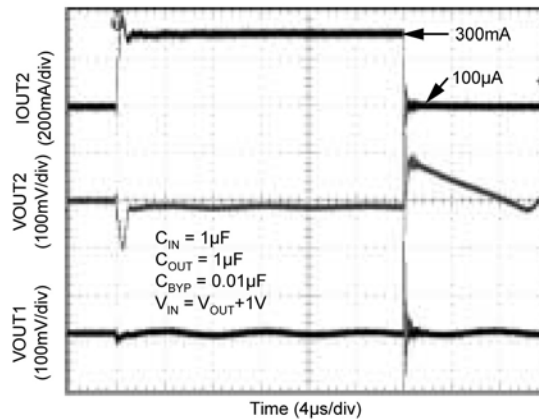

Functional Diagram

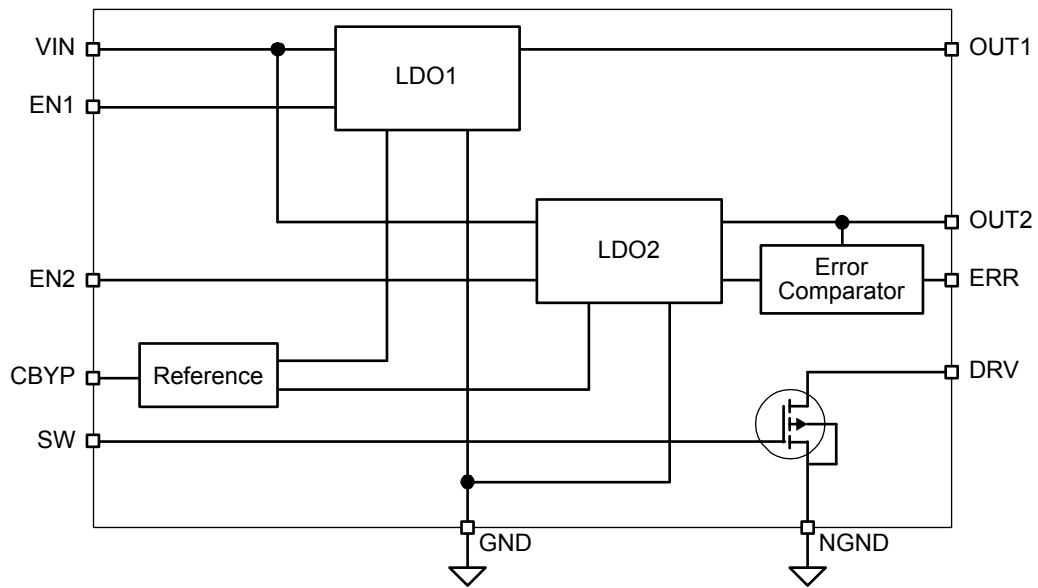

MIC2210 Fixed Voltage Block Diagram

Functional Description

The MIC2210 is a high performance, low quiescent current power management IC consisting of two μ Cap low dropout regulators, an open-drain driver. The first regulator is capable of sourcing 150mA at output voltages from 1.25V to 5V. The second regulator is capable of sourcing 300mA of current at output voltages from 1.25V to 5V. An open-drain driver completes the power management chipset, offering the capability of driving LEDs for keypad backlighting in applications such as cell phones.

Enable 1 and 2

The enable inputs allow for logic control of both output voltages with individual enable inputs. The enable input is active high, requiring 1.8V for guaranteed operation. The enable input is CMOS logic and cannot be left floating.

Open-Drain Driver (DRV)

The drive (DRV) pin is an open-drain output capable of sinking 150mA of current. This output is controlled by a logic level input, the switch (SW) pin. The switch pin is an active high input and cannot be left floating.

Input Capacitor

Good bypassing is recommended from input to ground to help improve AC performance. A $1\mu\text{F}$ capacitor or greater located close to the IC is recommended.

Bypass Capacitor

The internal reference voltage of the MIC2210 can be by-passed with a capacitor to ground to reduce output noise and increase power supply rejection (PSRR). A quick-start feature allows for quick turn-on of the output voltage regardless of the size of the capacitor. The recommended nominal bypass capacitor is $0.01\mu\text{F}$, but it can be increased without limit.

Output Capacitor

Each regulator output requires a $1\mu\text{F}$ ceramic output capacitor for stability. The output capacitor value can be increased to improve transient response, but performance has been optimized for a $1\mu\text{F}$ ceramic type output capacitor.

X7R/X5R dielectric-type ceramic capacitors are recommended because of their temperature performance. X7R-type capacitors change capacitance by 15% over their operating temperature range and are the most stable type of ceramic capacitors. Z5U and Y5V dielectric capacitors change value by as much as 50% and 60% respectively over their operating temperature ranges. To use a ceramic chip capacitor with Y5V dielectric, the value must be much higher than a X7R ceramic capacitor to ensure the same minimum capacitance over the equivalent operating temperature range.

Package Information

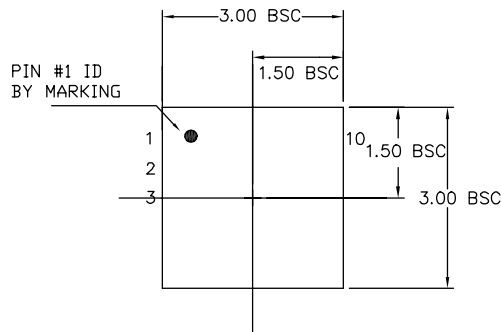

TOP VIEW

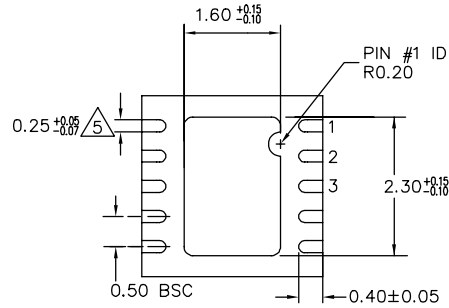

BOTTOM VIEW

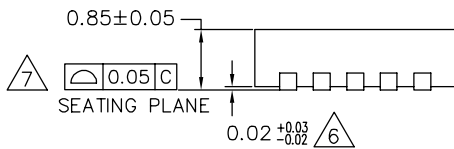

SIDE VIEW

NOTE:

1. ALL DIMENSIONS ARE IN MILLIMETERS.
 2. MAX. PACKAGE WARPAGE IS 0.05 mm.
 3. MAXIMUM ALLOWABLE BURRS IS 0.076 mm IN ALL DIRECTIONS.
 4. PIN #1 ID ON TOP WILL BE LASER/INK MARKED.
- △ DIMENSION APPLIES TO METALIZED TERMINAL AND IS MEASURED BETWEEN 0.20 AND 0.25 mm FROM TERMINAL TIP.
- △ APPLIED ONLY FOR TERMINALS.
- △ APPLIED FOR EXPOSED PAD AND TERMINALS.

10-Pin 3mm x 3mm MLF[®] (ML)

MICREL, INC. 2180 FORTUNE DRIVE SAN JOSE, CA 95131 USA
 TEL +1 (408) 944-0800 FAX +1 (408) 474-1000 WEB <http://www.micrel.com>

The information furnished by Micrel in this data sheet is believed to be accurate and reliable. However, no responsibility is assumed by Micrel for its use. Micrel reserves the right to change circuitry and specifications at any time without notification to the customer.

Micrel Products are not designed or authorized for use as components in life support appliances, devices or systems where malfunction of a product can reasonably be expected to result in personal injury. Life support devices or systems are devices or systems that (a) are intended for surgical implant into the body or (b) support or sustain life, and whose failure to perform can be reasonably expected to result in a significant injury to the user. A Purchaser's use or sale of Micrel Products for use in life support appliances, devices or systems is a Purchaser's own risk and Purchaser agrees to fully indemnify Micrel for any damages resulting from such use or sale.

© 2002 Micrel, Incorporated.

X-ON Electronics

Largest Supplier of Electrical and Electronic Components

Click to view similar products for [Power Management IC Development Tools](#) category:

Click to view products by [Microchip](#) manufacturer:

Other Similar products are found below :

[EVAL6482H-DISC](#) [EVAL-AD5522EBUZ](#) [EVAL-ADM1060EBZ](#) [EVAL-ADM1073MEBZ](#) [EVAL-ADM1166TQEBZ](#) [EVAL-ADM1168LQEBZ](#) [EVAL-ADM1171EBZ](#) [EVAL-ADM1276EBZ](#) [EVB-EN5319QI](#) [EVB-EN5365QI](#) [EVB-EN6347QI](#) [EVB-EP5348UI](#) [MIC23158YML EV](#) [MIC23451-AAAYFL EV](#) [MIC5281YMME EV](#) [124352-HMC860LP3E](#) [ADM00513](#) [ADM8611-EVALZ](#) [ADM8612-EVALZ](#) [ADM8613-EVALZ](#) [ADP1046ADC1-EVALZ](#) [ADP1055-EVALZ](#) [ADP122-3.3-EVALZ](#) [ADP130-0.8-EVALZ](#) [ADP130-1.2-EVALZ](#) [ADP130-1.5-EVALZ](#) [ADP130-1.8-EVALZ](#) [ADP160UJZ-REDYKIT](#) [ADP166UJ-EVALZ](#) [ADP1712-3.3-EVALZ](#) [ADP1714-3.3-EVALZ](#) [ADP1715-3.3-EVALZ](#) [ADP1716-2.5-EVALZ](#) [ADP1740-1.5-EVALZ](#) [ADP1752-1.5-EVALZ](#) [ADP1754-1.5-EVALZ](#) [ADP1828LC-EVALZ](#) [ADP1870-0.3-EVALZ](#) [ADP1871-0.6-EVALZ](#) [ADP1873-0.6-EVALZ](#) [ADP1874-0.3-EVALZ](#) [ADP1876-EVALZ](#) [ADP1879-1.0-EVALZ](#) [ADP1882-1.0-EVALZ](#) [ADP1883-0.6-EVALZ](#) [ADP197CB-EVALZ](#) [ADP199CB-EVALZ](#) [ADP2102-1.25-EVALZ](#) [ADP2102-1.2-EVALZ](#) [ADP2102-1.875EVALZ](#)